1A VOLTAGE REGULATOR (Operating Voltage up to 16V)

NO.EA-183-111116

OUTLINE

The R1190x series are a low supply current voltage regulator with high output voltage accuracy. The maximum operating voltage is 16V and the output current is 1A. Each of these ICs consists of a voltage reference unit, an error amplifier, a resistor-net for voltage setting, as a short current protection, a peak current protection, a thermal shutdown, an inrush current limit and a chip enable circuit. The wide input voltage range (Max. 16V). Additionally, the output voltage is fixed internally, in the range from 2.0V to 12.0V by the 0.1V steps. The supply current of R1190x series is excellent (Typ. 150 μ A) moreover R1190x series has the standby mode (Typ. 0.1 μ A) by the chip enable function.

Since the package for these ICs are TO-252-5-P2, SOT-89-5 and HSOP-6J with high power dissipation, high density mounting of the ICs on boards is possible.

FEATURES

- Input Voltage Range 3.5V to 16V
- Supply Current Typ. 150 μ A
- Standby Current Typ. 0.1 μ A
- Output Voltage Range 2.0V to 12.0V (0.1V steps)
(For other voltages, please refer to MARK INFORMATION.)
- Output Voltage Accuracy $\pm 1.5\%$
- Temperature-Drift Coefficient of Output Voltage ... Typ. ± 100 ppm/ $^{\circ}$ C
- Dropout Voltage Typ. 1.1V ($I_{OUT}=1A$, $V_{OUT}=5V$)
- Output Current Min. 1A ($3.3V \leq V_{OUT} \leq 12.0V$)
- Line Regulation Typ. 0.02%/V
- Packages SOT-89-5, HSOP-6J, TO-252-5-P2
- Built-in Fold Back Protection Circuit Typ. 300mA (Current at short mode)
- Built-in Thermal Shutdown Circuit
- Built-in Inrush Current Limit Circuit The Delay Pin for setting Inrush Current Limit Time

APPLICATIONS

- Power source for digital home appliances.
- Power source for audio visual equipments.

BLOCK DIAGRAMS

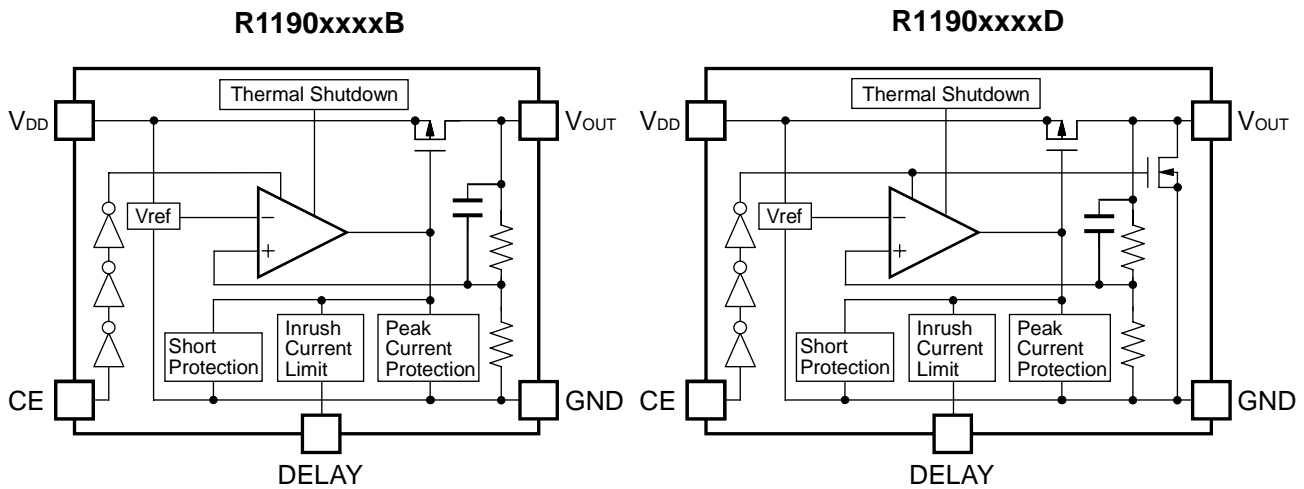

SELECTION GUIDE

The output voltage, auto discharge function, package for the ICs can be selected at the user's request.

Product Name	Package	Quantity per Reel	Pb Free	Halogen Free
R1190Hxxx*-T1-FE	SOT-89-5	1,000 pcs	Yes	Yes
R1190Sxxx*-E2-FE	HSOP-6J	1,000 pcs	Yes	Yes
R1190Jxxx*-T1-FE	TO-252-5-P2	3,000 pcs	Yes	Yes

xxx : The output voltage can be designated in the range of 2.0V(020) to 12.0V(120) in 0.1V steps.
(For other voltages, please refer to MARK INFORMATIONS.)

* : The auto discharge function at off state are options as follows.
(B) without auto discharge function at off state
(D) with auto discharge function at off state

PIN CONFIGURATIONS

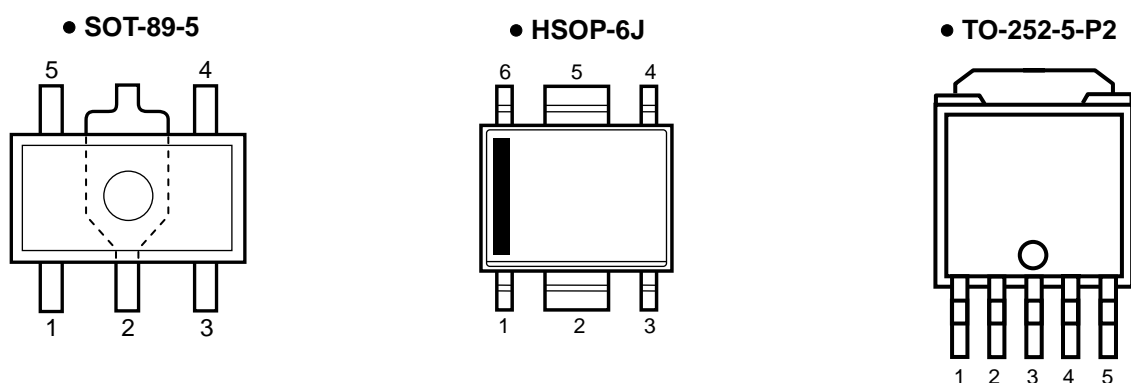

PIN DESCRIPTIONS

• SOT-89-5

Pin No.	Symbol	Description
1	V_{OUT}	Output Pin
2	GND	Ground Pin
3	CE	Chip Enable Pin ("H" Active)
4	DELAY	Delay Pin (for setting Inrush Current Limit Time)
5	V_{DD}	Input Pin

• HSOP-6J

Pin No.	Symbol	Description
1	V_{OUT}	Output Pin
2	GND	Ground Pin
3	CE	Chip Enable Pin ("H" Active)
4	DELAY	Delay Pin (for setting Inrush Current Limit Time)
5	GND	Ground Pin
6	V_{DD}	Input Pin

• HSOP-6J

Pin No.	Symbol	Description
1	DELAY	Delay Pin (for setting Inrush Current Limit Time)
2	V_{DD}	Input Pin
3	GND	Ground Pin
4	V_{OUT}	Output Pin
5	CE	Chip Enable Pin ("H" Active)

ABSOLUTE MAXIMUM RATINGS

Symbol	Item	Rating	Unit
V_{IN}	Input Voltage	-0.3 to 18	V
V_{CE}	Input Voltage (CE Pin)	-0.3 to $V_{IN}+0.3 \leq 18$	V
V_{OUT}	Output Voltage	-0.3 to $V_{IN}+0.3 \leq 18$	V
P_D	Power Dissipation (SOT-89-5) *	900	mW
	Power Dissipation (HSOP-6J) *	1700	
	Power Dissipation (TO-252-5-P2) *	1900	
T_{opt}	Operating Temperature Range	-40 to 85	°C
T_{stg}	Storage Temperature Range	-55 to 125	°C

*) For Power Dissipation, please refer to PACKAGE INFORMATION.

ABSOLUTE MAXIMUM RATINGS

Electronic and mechanical stress momentarily exceeded absolute maximum ratings may cause the permanent damages and may degrade the life time and safety for both device and system using the device in the field.

The functional operation at or over these absolute maximum ratings is not assured.

RECOMMENDED OPERATING CONDITIONS (ELECTRICAL CHARACTERISTICS)

All of electronic equipment should be designed that the mounted semiconductor devices operate within the recommended operating conditions. The semiconductor devices cannot operate normally over the recommended operating conditions, even if when they are used over such conditions by momentary electronic noise or surge. And the semiconductor devices may receive serious damage when they continue to operate over the recommended operating conditions.

ELECTRICAL CHARACTERISTICS

$V_{IN}=V_{CE}=\text{Set } V_{OUT}+2.0V$, $C_{IN}=C_{OUT}=4.7\mu F$, $I_{OUT}=1mA$, unless otherwise noted.

The specification in is checked and guaranteed by design engineering at $-40^{\circ}C \leq T_{opt} \leq 85^{\circ}C$.

• R1190x

$T_{opt}=25^{\circ}C$

Symbol	Item	Conditions	Min.	Typ.	Max.	Unit
V_{OUT}	Output Voltage	$I_{OUT}=1mA$	$T_{opt}=25^{\circ}C$	$\times 0.985$	$\times 1.015$	V
			$-40^{\circ}C \leq T_{opt} \leq 85^{\circ}C$	×0.973	×1.027	
$\Delta V_{OUT}/\Delta I_{OUT}$	Load Regulation	Refer to the following table				
V_{DIF}	Dropout Voltage	Refer to the following table				
I_{SS}	Supply Current	$I_{OUT}=0mA$		150	220	μA
$I_{standby}$	Standby Current (CE Off State)	$V_{IN}=16V$ $V_{CE}=0V$		0.1	1.0	μA
$\Delta V_{OUT}/\Delta V_{IN}$	Line Regulation	$V_{OUT}+0.5V$ (Min.3.5V) $\leq V_{IN} \leq 16V$ $I_{OUT}=1mA$		0.02	0.10	%/V
RR	Ripple Rejection	$f=1kHz$, $I_{OUT}=100mA$		60		dB
V_{IN}	Input Voltage		3.5		16	V
$\frac{\Delta V_{OUT}}{\Delta T_{opt}}$	Output Voltage Temperature Coefficient	$I_{OUT}=1mA$, $-40^{\circ}C \leq T_{opt} \leq 85^{\circ}C$		± 100		ppm/ $^{\circ}C$
I_{LIM}	Output Current	Refer to the following table				
I_{SC}	Short Current Limit	$V_{OUT}=0V$		300		mA
V_{CEH}	CE Input Voltage "H"		1.6		V_{IN}	V
V_{CEL}	CE Input Voltage "L"		0		0.6	V
T_{TSD}	Thermal Shutdown Temperature	Junction Temperature		150		$^{\circ}C$
T_{TSR}	Thermal Shutdown Released Temperature	Junction Temperature		130		$^{\circ}C$
R_{LOW}	Low Output Nch Tr. ON Resistance (of D version)	$V_{IN}=5.0V$ $V_{CE}=0V$ $V_{OUT}=0.3V$		150		Ω

All of units are tested and specified under pulse load conditions such that $T_j \approx T_{opt}=25^{\circ}C$ except for Ripple Rejection, Output Voltage Temperature Coefficient, Thermal Shutdown, Load Regulation at 600mA ($2.0V \leq V_{OUT} < 2.5V$) and at 700mA ($2.5V \leq V_{OUT} < 3.3V$) and at 1000mA ($3.3V \leq V_{OUT} \leq 12.0V$), Dropout Voltage at 600mA ($2.0V \leq V_{OUT} < 2.5V$) and at 700mA ($2.5V \leq V_{OUT} < 3.3V$) and at 1000mA ($3.3V \leq V_{OUT} \leq 12.0V$).

The specification in is checked and guaranteed by design engineering at $-40^{\circ}\text{C} \leq T_{\text{opt}} \leq 85^{\circ}\text{C}$.

● Output Current by Output Voltage

Output Voltage V_{OUT}	Output Current I_{LIM} (mA)	
	Condition	Min.
$2.0\text{V} \leq V_{\text{OUT}} < 2.5\text{V}$	$V_{\text{IN}}=V_{\text{OUT}}+2.3\text{V}$	600
$2.5\text{V} \leq V_{\text{OUT}} < 3.3\text{V}$		700
$3.3\text{V} \leq V_{\text{OUT}} \leq 12.0\text{V}$		1000

● Load Regulation by Output Voltage

$T_{\text{opt}}=25^{\circ}\text{C}$

Output Voltage V_{OUT}	Load Regulation $\Delta V_{\text{OUT}}/\Delta I_{\text{OUT}}$ (mV)		
	Condition	Typ.	Max.
$2.0\text{V} \leq V_{\text{OUT}} < 5.0\text{V}$	$V_{\text{IN}}=V_{\text{OUT}}+2.3\text{V}, 1\text{mA} \leq I_{\text{OUT}} \leq 200\text{mA}$	20	60
$5.0\text{V} \leq V_{\text{OUT}} \leq 12.0\text{V}$		40	100
$2.0\text{V} \leq V_{\text{OUT}} < 2.5\text{V}$	$V_{\text{IN}}=V_{\text{OUT}}+2.3\text{V}, 1\text{mA} \leq I_{\text{OUT}} \leq 600\text{mA}$	80	180
$2.5\text{V} \leq V_{\text{OUT}} < 3.3\text{V}$	$V_{\text{IN}}=V_{\text{OUT}}+2.3\text{V}, 1\text{mA} \leq I_{\text{OUT}} \leq 700\text{mA}$	90	200
$3.3\text{V} \leq V_{\text{OUT}} < 5.0\text{V}$	$V_{\text{IN}}=V_{\text{OUT}}+2.3\text{V}, 1\text{mA} \leq I_{\text{OUT}} \leq 1\text{A}$	120	230
$5.0\text{V} \leq V_{\text{OUT}} \leq 12.0\text{V}$		130	250

● Dropout Voltage by Output Voltage

$T_{\text{opt}}=25^{\circ}\text{C}$

Output Voltage V_{OUT}	Dropout Voltage V_{DIF} (V)						
	Condition	Typ.	Max.	Condition	Typ.	Max.	
2.0V	$I_{\text{OUT}}=200\text{mA}$	/	1.5	$I_{\text{OUT}}=600\text{mA}$	1.6	2.2	
2.1V			1.4				
2.2V			1.3				
2.3V			1.2				
2.4V			1.1				
2.5V			1.0	$I_{\text{OUT}}=700\text{mA}$	1.5	2.15	
2.6V			0.9				
2.7V			0.8				
$2.8\text{V} \leq V_{\text{OUT}} < 3.1\text{V}$				0.7			
$3.1\text{V} \leq V_{\text{OUT}} < 3.3\text{V}$			0.4	0.7			
$3.3\text{V} \leq V_{\text{OUT}} < 4.0\text{V}$			0.3	0.53	$I_{\text{OUT}}=1\text{A}$	1.6	2.3
$4.0\text{V} \leq V_{\text{OUT}} < 5.0\text{V}$			0.25	0.42		1.4	2.1
$5.0\text{V} \leq V_{\text{OUT}} < 9.0\text{V}$			0.19	0.31		1.1	1.85
$9.0\text{V} \leq V_{\text{OUT}} \leq 12.0\text{V}$	0.1	0.18	0.8	1.30			

All of units are tested and specified under pulse load conditions such that $T_{\text{j}} \approx T_{\text{opt}} = 25^{\circ}\text{C}$ except for Ripple Rejection, Output Voltage Temperature Coefficient, Thermal Shutdown, Load Regulation at 600mA ($2.0\text{V} \leq V_{\text{OUT}} < 2.5\text{V}$) and at 700mA ($2.5\text{V} \leq V_{\text{OUT}} < 3.3\text{V}$) and at 1000mA ($3.3\text{V} \leq V_{\text{OUT}} \leq 12.0\text{V}$), Dropout Voltage at 600mA ($2.0\text{V} \leq V_{\text{OUT}} < 2.5\text{V}$) and at 700mA ($2.5\text{V} \leq V_{\text{OUT}} < 3.3\text{V}$) and at 1000mA ($3.3\text{V} \leq V_{\text{OUT}} \leq 12.0\text{V}$).

TYPICAL APPLICATION



(External Components)

C1, C2: Ceramic Capacitor 4.7 μ F Nippon Chemi-con Corporation KTD500B475M43A0T00

TECHNICAL NOTES

When using these ICs, consider the following points:

Phase Compensation

In these ICs, phase compensation is made for securing stable operation even if the load current is varied. For this purpose, use a capacitor C_{OUT} with good frequency characteristics and ESR (Equivalent Series Resistance). (Note: If additional ceramic capacitors are connected with parallel to the output pin with an output capacitor for phase compensation, the operation might be unstable. Because of this, test these ICs with as same external components as ones to be used on the PCB.)

PCB Layout

Make V_{DD} and GND lines sufficient. If their impedance is high, noise pickup or unstable operation may result. Connect a capacitor with a capacitance value as much as 4.7 μ F or more between V_{DD} and GND pin, and as close as possible to the pins.

Set external components, especially the output capacitor, as close as possible to the ICs, and make wiring as short as possible. (Refer to the TYPICAL APPLICATION diagram above.)

Thermal Shutdown

There is the built-in thermal-shutdown function in R1190x series. It discontinues operation of the IC when the junction temperature becomes over 150°C (Typ.) and IC re-operates when the junction temperature under 130°C. If the temperature increasing keeps the IC repeats ON and OFF operating. The output becomes the pulse condition.

Chip Enable Circuit

For the output voltage stability, please do not use the intermediate electric potential (the voltage value between V_{CEH} and V_{CEL}) that causes the supply current increasing and the unstable of output voltage.

Inrush-Current Limit Function

R1190x Series has the function to limit the inrush-current, it limited approximately 0.3A when the voltage regulator is turn ON. It is also possible to set time of the rush-current limitation by connecting capacitor with DELAY pin. The rush-current time (t_D) and the value of capacitor (C_D (F)) is calculatable by the following formula;

$$t_D=(0.000198+(3.79\times 10^7\times C_D))\times V_{IN}$$

The inrush-current is limited even if the capacitor is not connected with the DELAY pin. In this case, the time is calculated as $C_D=0$ by the formula above.

Though, if the value of time is insufficient for controlling the inrush-current, please connect the capacitor with DELAY pin. The DELAY pin is used as OPEN when the capacitor is not used. Please use the DELAY pin as OPEN when the capacitor is not used.

Auto-Discharge Function

R1190xxxxD series has the auto-discharge function. When "L" signal is put into the Chip-enable pin (CE), the switch between V_{OUT} and GND is turned ON and the charge at capacitor is discharge rapidly by the auto-discharge function.

TEST CIRCUITS



Basic Test Circuit

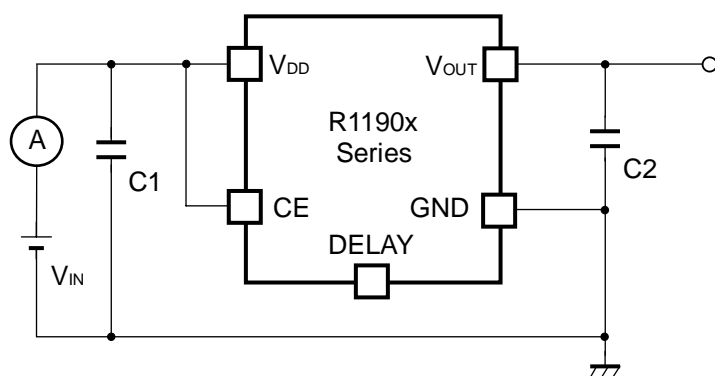

Test Circuit for Supply Current

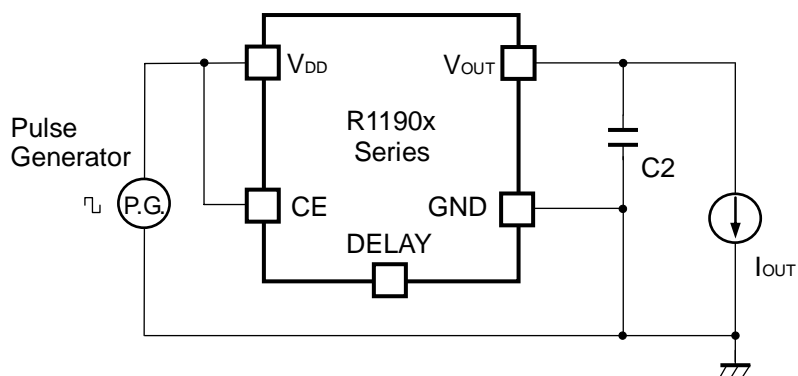

Test Circuit for Ripple Rejection



Test Circuit for Load Transient Response

TYPICAL CHARACTERISTIC

1) Output Voltage vs. Output Current ($C_1=C_2=4.7\mu\text{F}$, $T_{\text{opt}}=25^\circ\text{C}$)

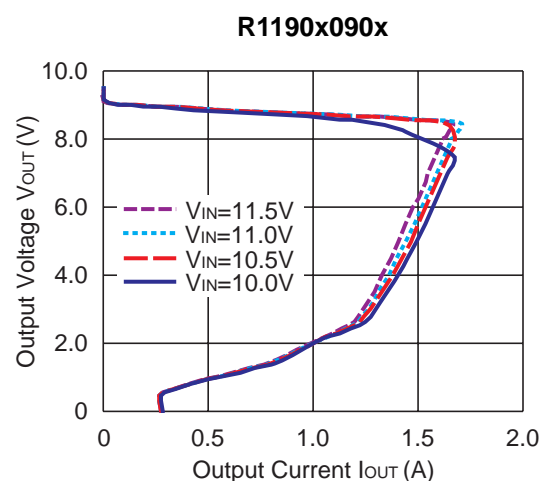
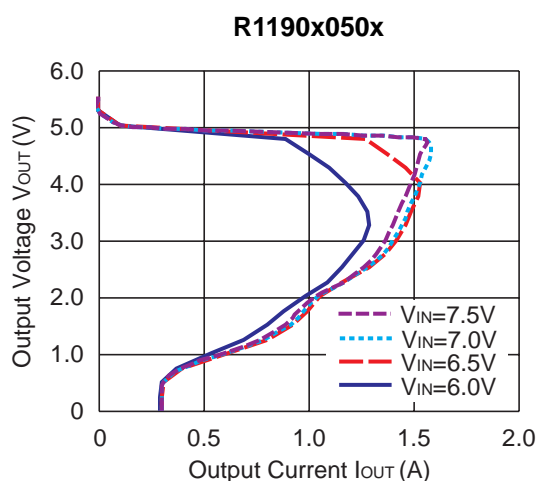
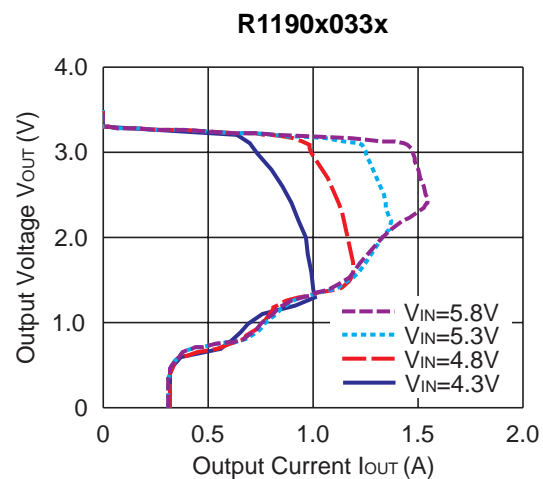
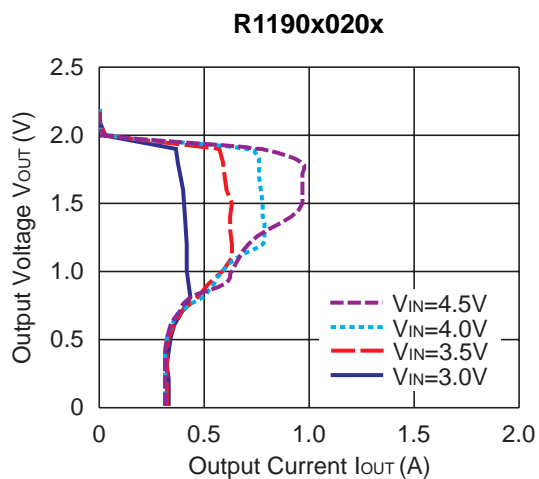

2) Output Voltage vs. Input Voltage ($C1=C2=4.7\mu\text{F}$, $T_{opt}=25^\circ\text{C}$)

R1190x020x

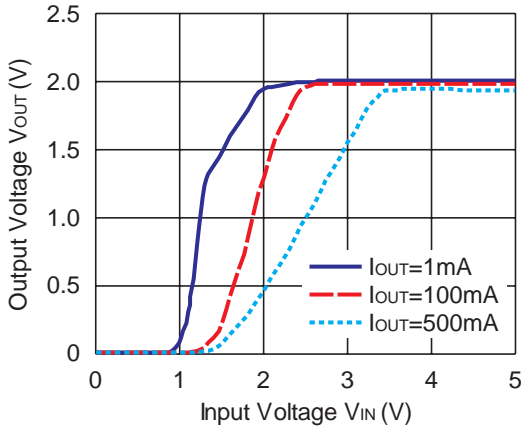

R1190x033x

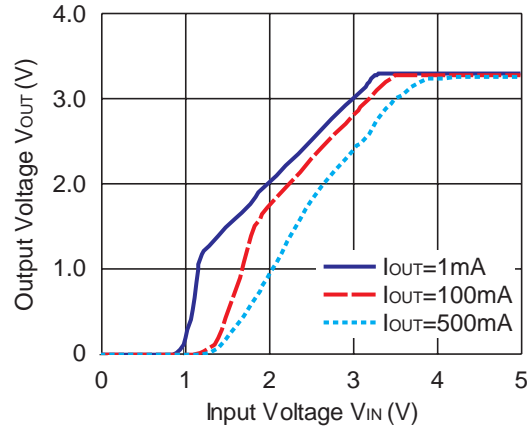

R1190x050x



R1190x090x

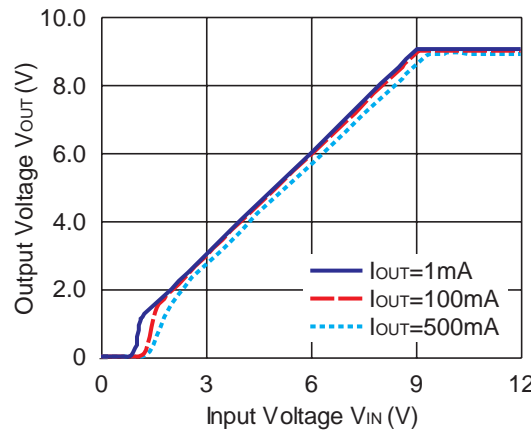

R1190x120x

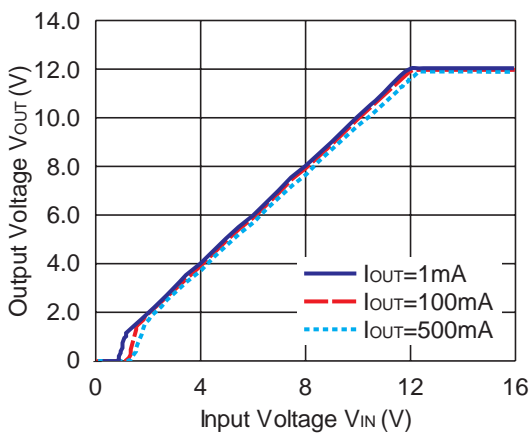

3) Supply Current vs. Input Voltage ($C_1=C_2=4.7\mu\text{F}$, $T_{\text{opt}}=25^\circ\text{C}$)

R1190x020x



R1190x033x



R1190x050x

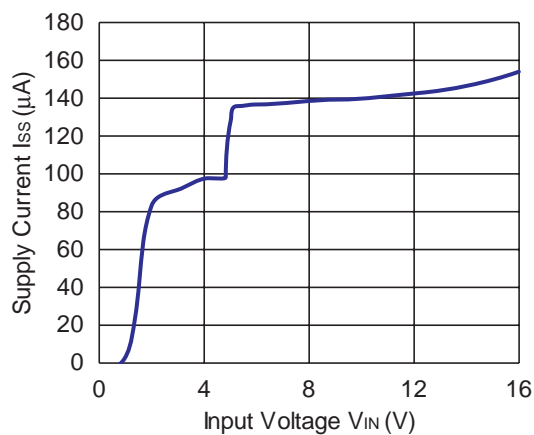

R1190x090x

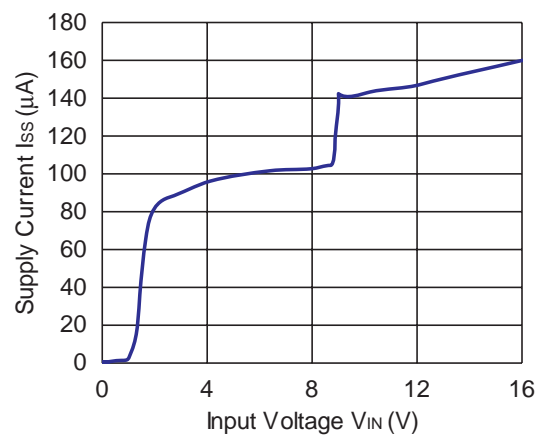

R1190x120x



4) Output Voltage vs. Temperature (C1=C2=4.7μF, I_{OUT}=1mA)

R1190x020x

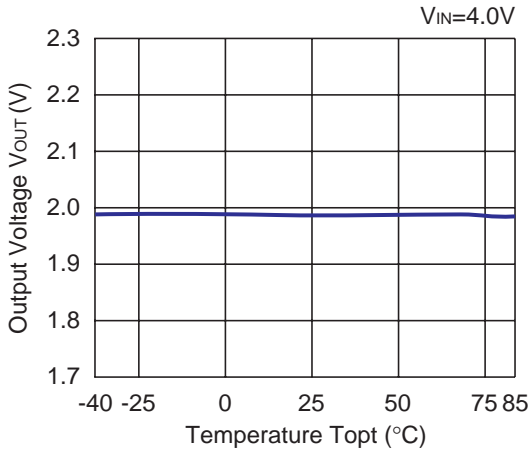

R1190x033x

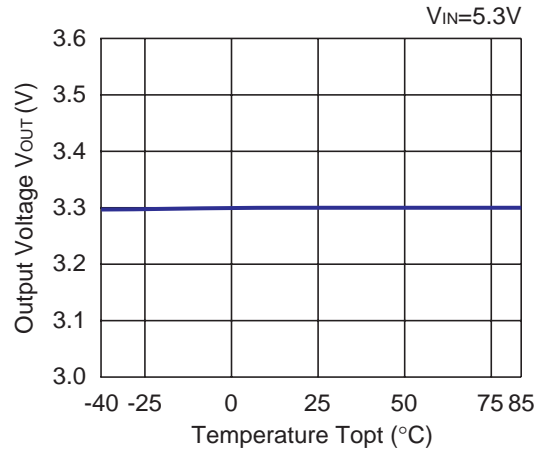

R1190x050x

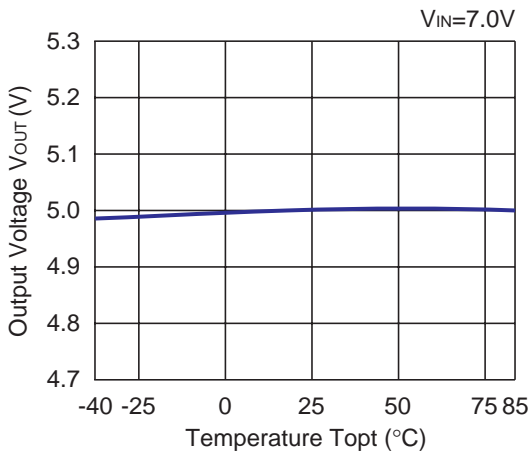

R1190x090x

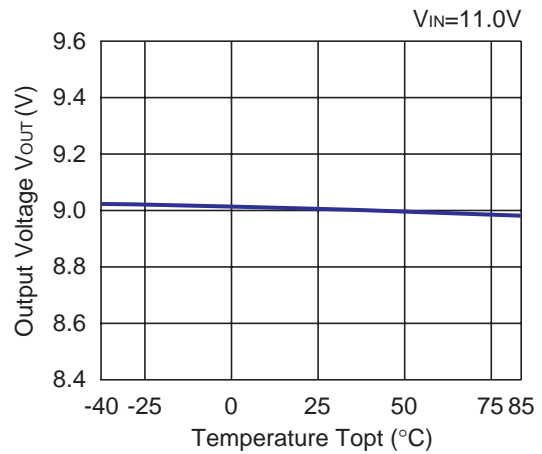

R1190x120x

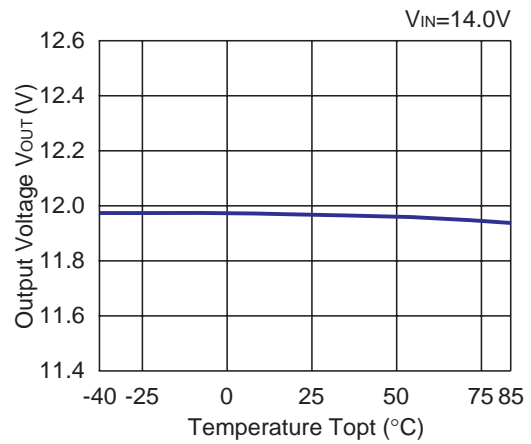

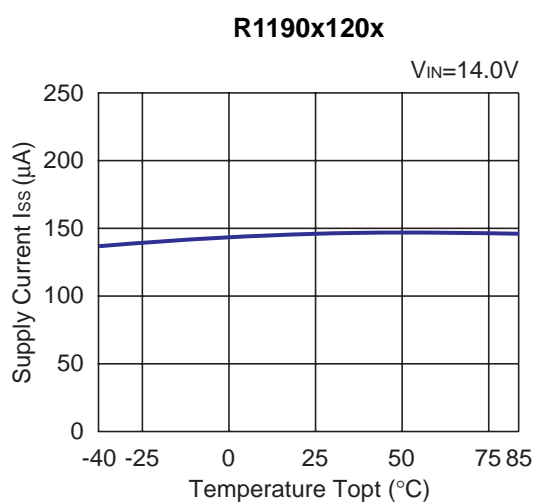
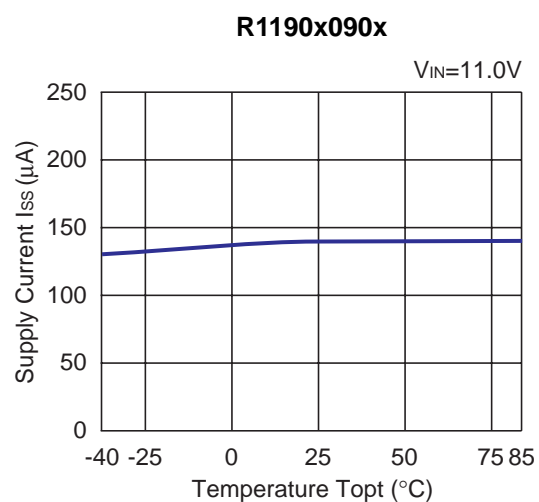
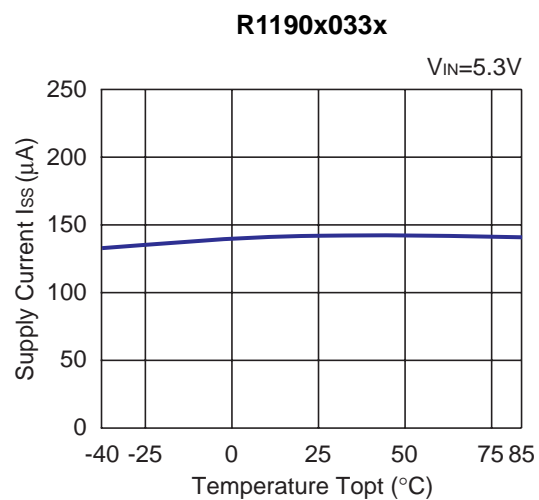
5) Supply Current vs. Temperature (C1=C2=4.7 μ F)

6) Dropout Voltage vs. Output Current (C1=C2=4.7μF)

R1190x020x

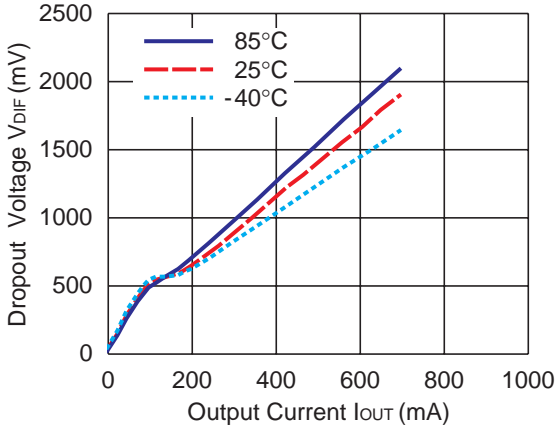

R1190x033x



R1190x050x

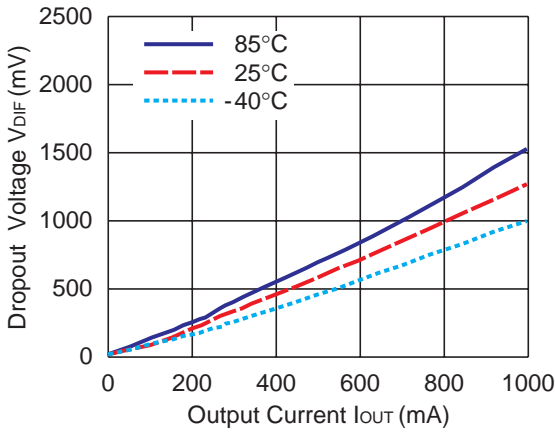

R1190x090x



R1190x120x

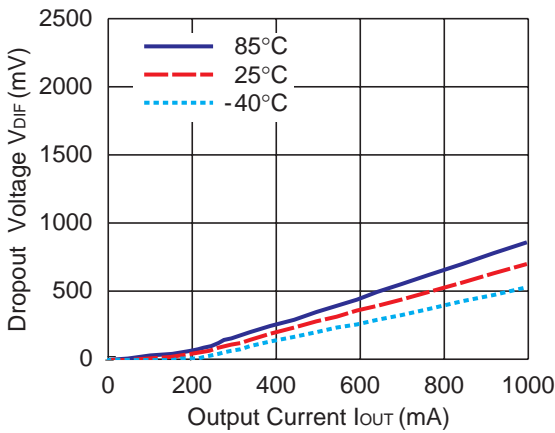

7) Dropout Voltage vs. Set Output Voltage ($C1=C2=4.7\mu\text{F}$, $T_{\text{opt}}=25^\circ\text{C}$)

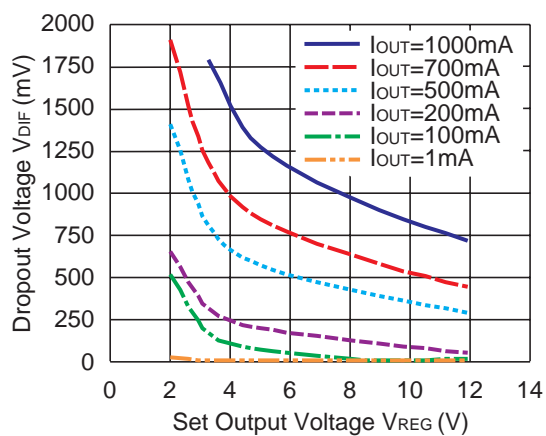

8) Ripple Rejection vs. Input Voltage ($C1=\text{none}$, $C2=4.7\mu\text{F}$, $I_{\text{OUT}}=100\text{mA}$, Ripple=0.2Vp-p, $T_{\text{opt}}=25^\circ\text{C}$)

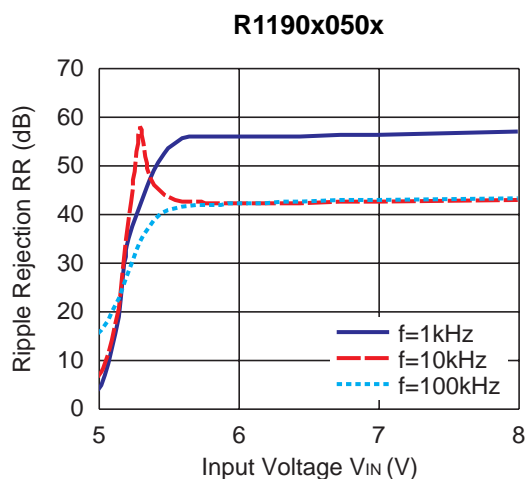



9) Ripple Rejection vs. Frequency ($C1=\text{none}$, $C2=4.7\mu\text{F}$, Ripple=0.2Vp-p, $T_{opt}=25^\circ\text{C}$)





10) Input Transient Response ($C1=none$, $C2=4.7\mu F$, $I_{OUT}=1mA$, $t_r=t_f=0.5\mu s$)

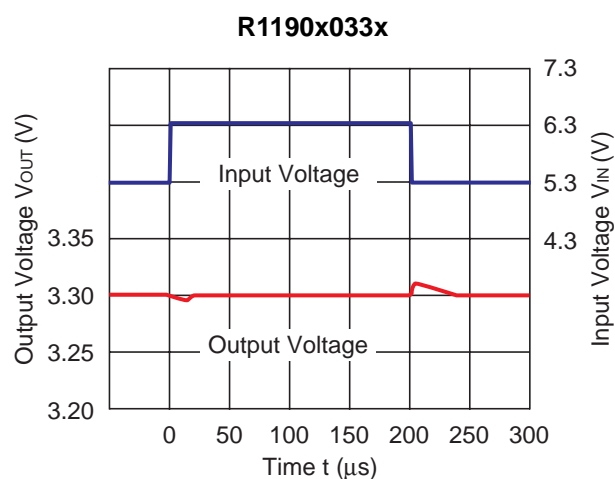
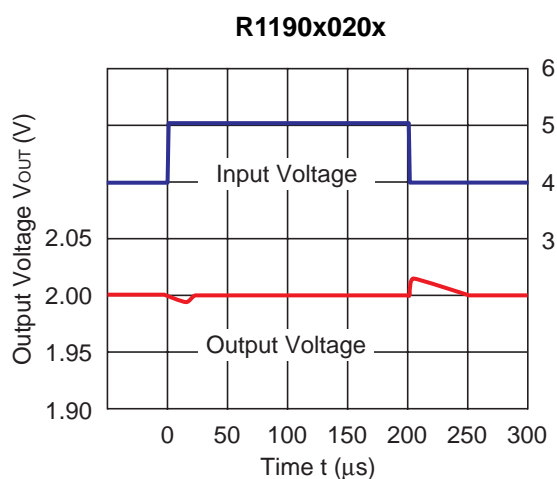

R1190x120x



11) Load Transient Response ($C1=C2=4.7\mu\text{F}$, $t_r=t_f=0.5\mu\text{s}$)

R1190x020x



R1190x033x



R1190x050x

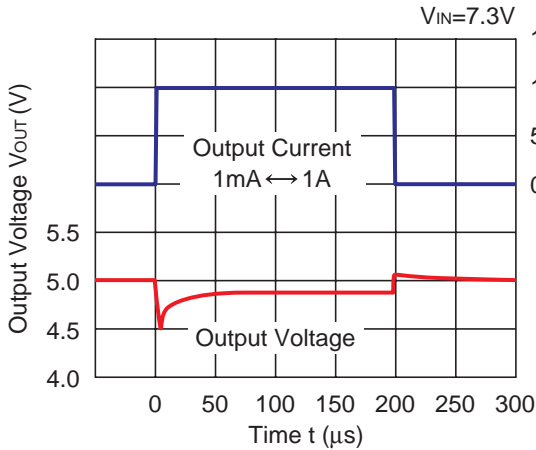

R1190x090x





12) Turn On Speed with CE Pin ($I_{OUT}=1mA$, $C1=C2=4.7\mu F$, $t_r=t_f=0.5\mu s$)

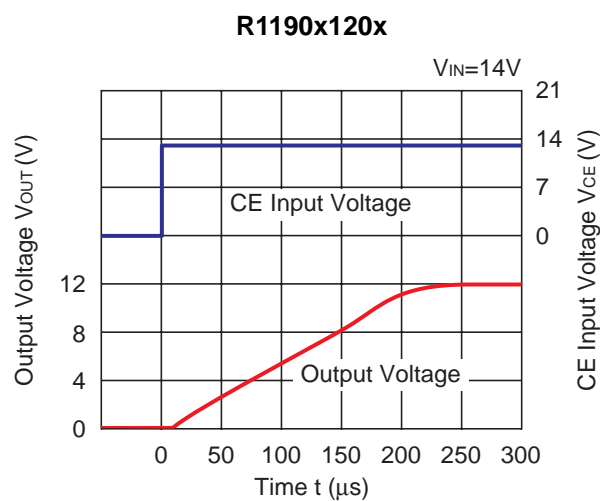
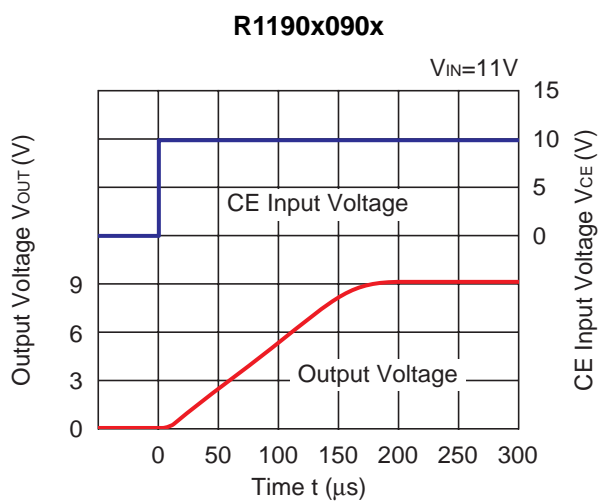

13) Turn Off Speed with CE Pin (D Version) ($I_{OUT}=1mA$, $C_1=C_2=4.7\mu F$, $t_r=t_f=0.5\mu s$)

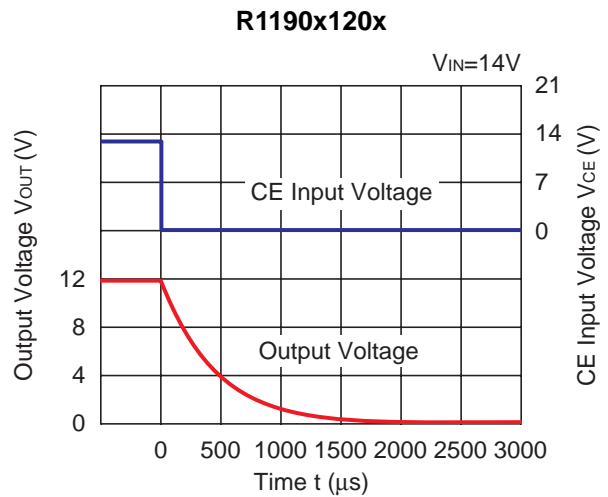
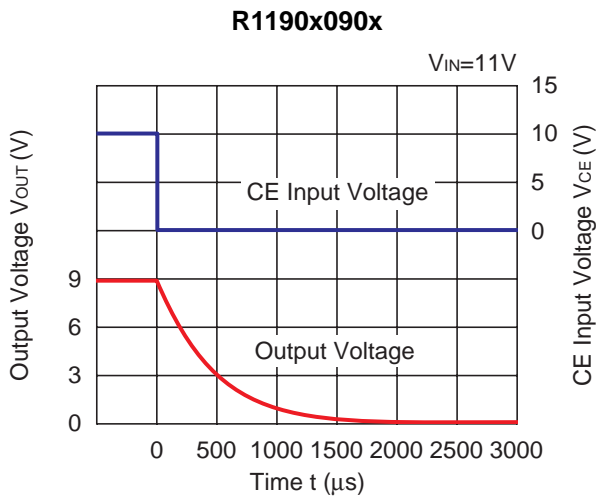
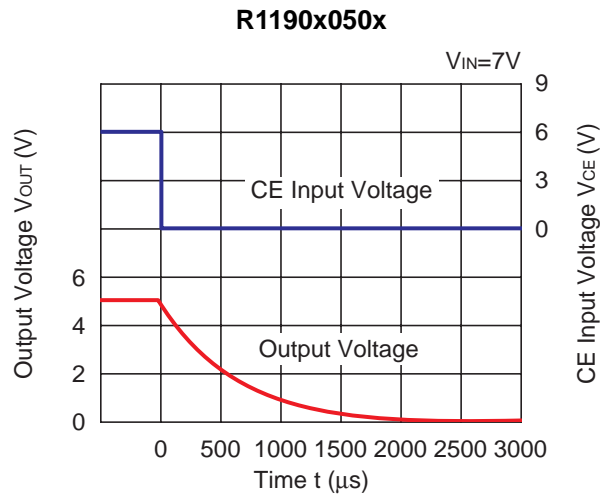
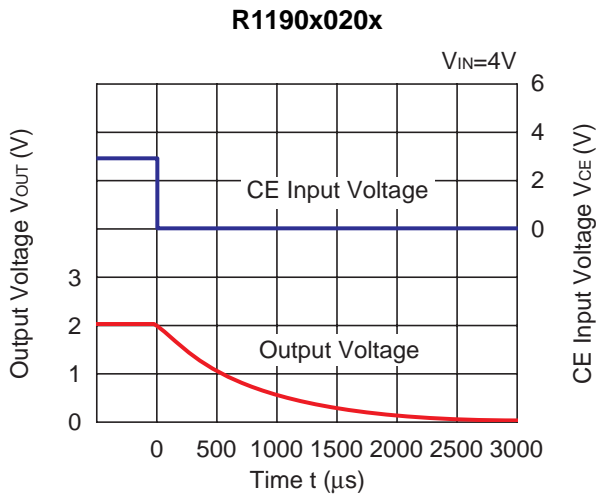

14) Inrush Current at Turn On ($V_{IN}=7.0V$, $C_1=C_2=4.7\mu F$, $C_D=none$, $t_r=t_f=0.5\mu s$)

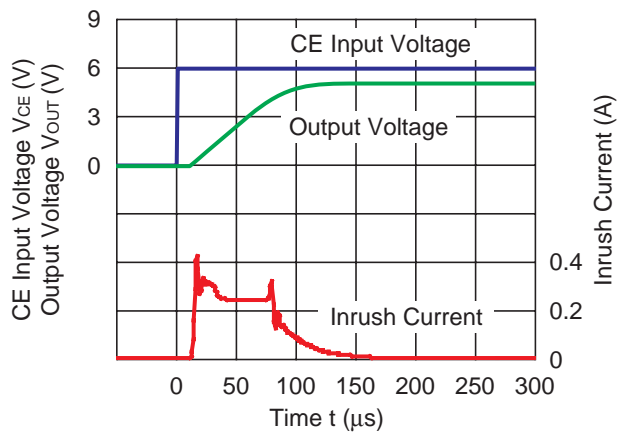

15) Inrush Current Limit vs. C_D Capacitance ($C_1=C_2=4.7\mu\text{F}$)



16) Inrush Current Limit Delay Time vs. Input Voltage ($C_1=C_2=4.7\mu\text{F}$)



17) Thermal Shutdown vs. Temperature ($C_1=C_2=4.7\mu\text{F}$)



ESR vs. Output Current

When using these ICs, consider the following points:

The relations between I_{OUT} (Output Current) and ESR of an output capacitor are shown below.

The conditions when the white noise level is under $40\mu V_{rms}$ (Avg.) are marked as the hatched area in the graph.

Measurement conditions

- Frequency Band : 10Hz to 1MHz
- Temperature : $-40^{\circ}C$ to $85^{\circ}C$
- Hatched Area : Noise level is under $40\mu V_{rms}$ (Avg.)
- C_{IN} : $4.7\mu F$ (KTD500B475M43A0T00)
- C_{OUT} : $4.7\mu F$ (KTD500B475M43A0T00)
: $10.0\mu F$ (FK22Y5V1H106Z)

R1190x020x



R1190x020x

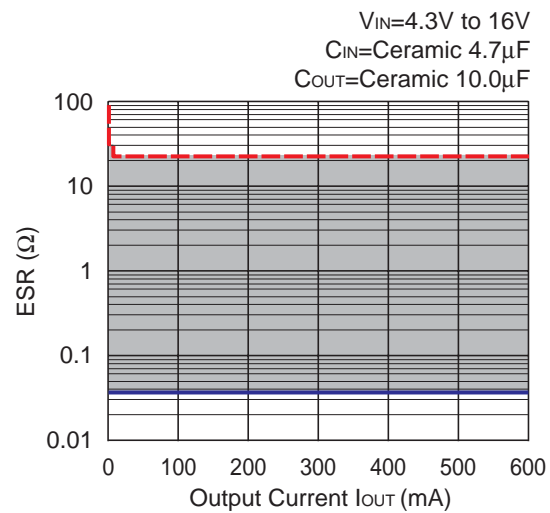

R1190x033x



R1190x033x



R1190x050x

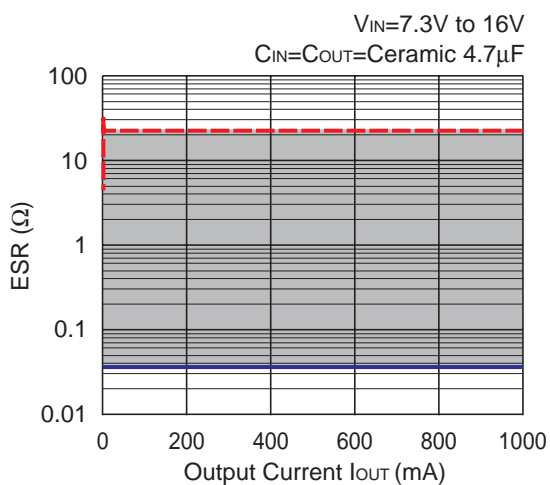

R1190x050x

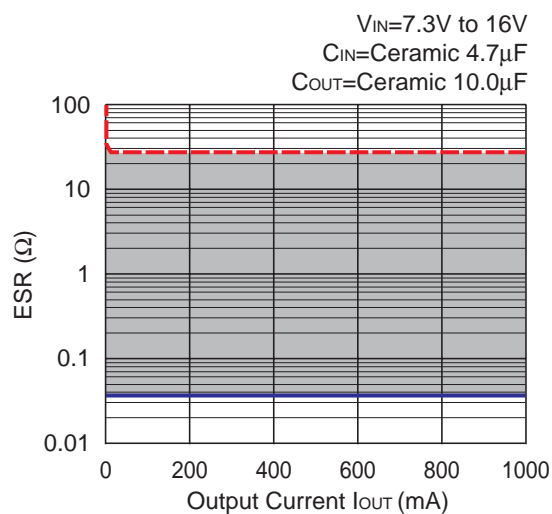

R1190x090x

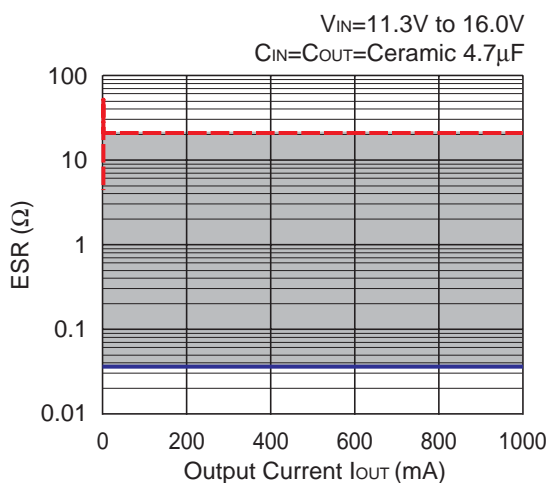

R1190x090x

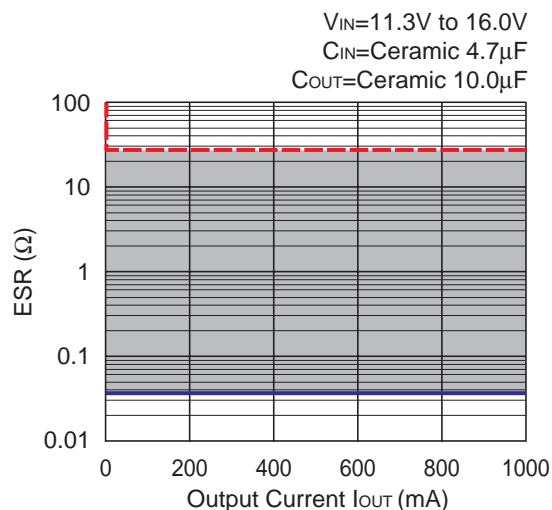

R1190x120x

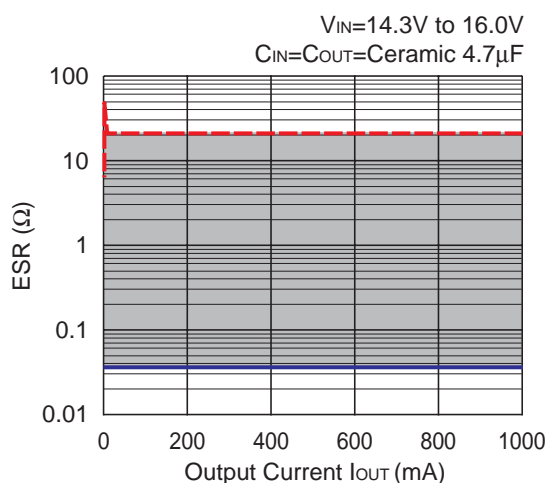

R1190x120x

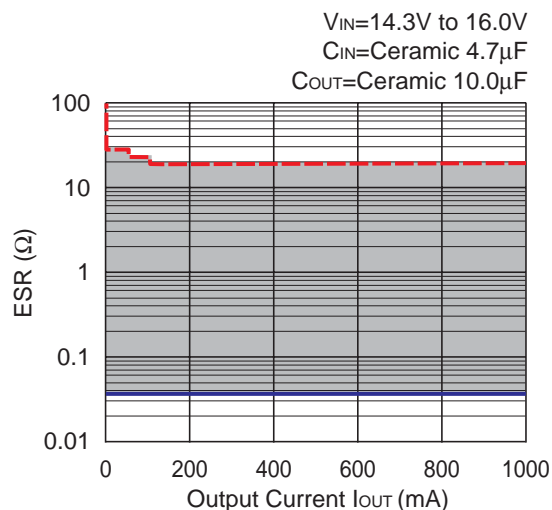



1. The products and the product specifications described in this document are subject to change or discontinuation of production without notice for reasons such as improvement. Therefore, before deciding to use the products, please refer to Ricoh sales representatives for the latest information thereon.
2. The materials in this document may not be copied or otherwise reproduced in whole or in part without prior written consent of Ricoh.
3. Please be sure to take any necessary formalities under relevant laws or regulations before exporting or otherwise taking out of your country the products or the technical information described herein.
4. The technical information described in this document shows typical characteristics of and example application circuits for the products. The release of such information is not to be construed as a warranty of or a grant of license under Ricoh's or any third party's intellectual property rights or any other rights.
5. The products listed in this document are intended and designed for use as general electronic components in standard applications (office equipment, telecommunication equipment, measuring instruments, consumer electronic products, amusement equipment etc.). Those customers intending to use a product in an application requiring extreme quality and reliability, for example, in a highly specific application where the failure or misoperation of the product could result in human injury or death (aircraft, spacevehicle, nuclear reactor control system, traffic control system, automotive and transportation equipment, combustion equipment, safety devices, life support system etc.) should first contact us.
6. We are making our continuous effort to improve the quality and reliability of our products, but semiconductor products are likely to fail with certain probability. In order to prevent any injury to persons or damages to property resulting from such failure, customers should be careful enough to incorporate safety measures in their design, such as redundancy feature, fire containment feature and fail-safe feature. We do not assume any liability or responsibility for any loss or damage arising from misuse or inappropriate use of the products.
7. Anti-radiation design is not implemented in the products described in this document.
8. Please contact Ricoh sales representatives should you have any questions or comments concerning the products or the technical information.



Ricoh is committed to reducing the environmental loading materials in electrical devices with a view to contributing to the protection of human health and the environment.

Ricoh has been providing RoHS compliant products since April 1, 2006 and Halogen-free products since April 1, 2012.

RICOH RICOH ELECTRONIC DEVICES CO., LTD.

<http://www.e-devices.ricoh.co.jp/en/>

Sales & Support Offices

RICOH ELECTRONIC DEVICES CO., LTD.

Higashi-Shinagawa Office (International Sales)
3-32-3, Higashi-Shinagawa, Shinagawa-ku, Tokyo 140-8655, Japan
Phone: +81-3-5479-2857 Fax: +81-3-5479-0502

RICOH EUROPE (NETHERLANDS) B.V.

Semiconductor Support Centre
Prof. W.H. Keesomlaan 1, 1183 DJ Amstelveen, The Netherlands
Phone: +31-20-5474-309

RICOH ELECTRONIC DEVICES KOREA CO., LTD.

3F, Haesung Bldg. 504, Teheran-ro, Gangnam-gu, Seoul, 135-725, Korea
Phone: +82-2-2135-5700 Fax: +82-2-2051-5713

RICOH ELECTRONIC DEVICES SHANGHAI CO., LTD.

Room 403, No.2 Building, No.690 Bilbo Road, Pu Dong New District, Shanghai 201203,
People's Republic of China
Phone: +86-21-5027-3200 Fax: +86-21-5027-3299

RICOH ELECTRONIC DEVICES CO., LTD.

Taipei office
Room 109, 10F-1, No.51, Hengyang Rd., Taipei City, Taiwan (R.O.C.)
Phone: +886-2-2313-1621/1622 Fax: +886-2-2313-1623

Mouser Electronics

Authorized Distributor

Click to View Pricing, Inventory, Delivery & Lifecycle Information:

Ricoh Electronics:

[R1190H050B-T1-FE](#) [R1190H033D-T1-FE](#) [R1190S050B-E2-FE](#) [R1190S050D-E2-FE](#) [R1190S033D-E2-FE](#)
[R1190S033B-E2-FE](#) [R1190H033B-T1-FE](#) [R1190H050D-T1-FE](#) [R1190S025B-E2-FE](#)

Компания «Океан Электроники» предлагает заключение долгосрочных отношений при поставках импортных электронных компонентов на взаимовыгодных условиях!

Наши преимущества:

- Поставка оригинальных импортных электронных компонентов напрямую с производств Америки, Европы и Азии, а так же с крупнейших складов мира;
- Широкая линейка поставок активных и пассивных импортных электронных компонентов (более 30 млн. наименований);
- Поставка сложных, дефицитных, либо снятых с производства позиций;
- Оперативные сроки поставки под заказ (от 5 рабочих дней);
- Экспресс доставка в любую точку России;
- Помощь Конструкторского Отдела и консультации квалифицированных инженеров;
- Техническая поддержка проекта, помощь в подборе аналогов, поставка прототипов;
- Поставка электронных компонентов под контролем ВП;
- Система менеджмента качества сертифицирована по Международному стандарту ISO 9001;
- При необходимости вся продукция военного и аэрокосмического назначения проходит испытания и сертификацию в лаборатории (по согласованию с заказчиком);
- Поставка специализированных компонентов военного и аэрокосмического уровня качества (Xilinx, Altera, Analog Devices, Intersil, Interpoint, Microsemi, Actel, Aeroflex, Peregrine, VPT, Syfer, Eurofarad, Texas Instruments, MS Kennedy, Miteq, Cobham, E2V, MA-COM, Hittite, Mini-Circuits, General Dynamics и др.);

Компания «Океан Электроники» является официальным дистрибьютором и эксклюзивным представителем в России одного из крупнейших производителей разъемов военного и аэрокосмического назначения «JONHON», а так же официальным дистрибьютором и эксклюзивным представителем в России производителя высокотехнологичных и надежных решений для передачи СВЧ сигналов «FORSTAR».



JONHON

«JONHON» (основан в 1970 г.)

Разъемы специального, военного и аэрокосмического назначения:

(Применяются в военной, авиационной, аэрокосмической, морской, железнодорожной, горно- и нефтедобывающей отраслях промышленности)

«FORSTAR» (основан в 1998 г.)

ВЧ соединители, коаксиальные кабели,
кабельные сборки и микроволновые компоненты:

(Применяются в телекоммуникациях гражданского и специального назначения, в средствах связи, РЛС, а так же военной, авиационной и аэрокосмической отраслях промышленности).



Телефон: 8 (812) 309-75-97 (многоканальный)

Факс: 8 (812) 320-03-32

Электронная почта: ocean@oceanchips.ru

Web: <http://oceanchips.ru/>

Адрес: 198099, г. Санкт-Петербург, ул. Калинина, д. 2, корп. 4, лит. А