

# Chip Beads

For power line

## MPZ series

|              |                  |                         |
|--------------|------------------|-------------------------|
| <b>Type:</b> | <b>MPZ0603</b>   | <b>0603[0201 inch]*</b> |
|              | <b>MPZ1005</b>   | <b>1005[0402 inch]</b>  |
|              | <b>MPZ1608</b>   | <b>1608[0603 inch]</b>  |
|              | <b>MPZ2012</b>   | <b>2012[0805 inch]</b>  |
|              | <b>MPZ1005-E</b> | <b>1005[0402 inch]</b>  |

\* Dimensions Code JIS[EIA]

Issue date: September 2012

- All specifications are subject to change without notice.
- Conformity to RoHS Directive: This means that, in conformity with EU Directive 2002/95/EC, lead, cadmium, mercury, hexavalent chromium, and specific bromine-based flame retardants, PBB and PBDE, have not been used, except for exempted applications.

# Chip Beads

## For Power Line

Conformity to RoHS Directive

### MPZ Series MPZ0603

#### FEATURES

- This chip bead implements a 0603 shape in its capacity as an EMC countermeasure component, and it supports compact devices that need smaller spaces.
- This product can cope with a high current due to its low DC resistance. It is also most suitable for lower power consumption.
- Because of its low DC resistance, it is useful for audio lines.
- No cross talk with closed magnetic circuit structural design.
- It is a product conforming to RoHS directive.

#### APPLICATIONS

Removal of power line noises of cellular phones, PCs, note PCs, TV tuners, STBs, audio players, DVDs, DSCs, DVCs, game machines, digital photo frames, etc.

#### PRODUCT IDENTIFICATION

|     |      |     |     |     |     |     |
|-----|------|-----|-----|-----|-----|-----|
| MPZ | 0603 | S   | 220 | C   | T   | □□□ |
| (1) | (2)  | (3) | (4) | (5) | (6) | (7) |

- (1) Series name
- (2) Dimensions L×W
- (3) Type name
- (4) Impedance  
220: 22Ω at 100MHz
- (5) Characteristic type
- (6) Packaging style  
T:Taping(reel)
- (7) TDK internal code

#### HANDLING AND PRECAUTIONS

- Before soldering, be sure to preheat components. The preheating temperature should be set so that the temperature difference between the solder temperature and product temperature does not exceed 150°C.
- After mounting components onto the printed circuit board, do not apply stress through board bending or mishandling.
- Do not expose the inductors to stray magnetic fields.
- Avoid static electricity discharge during handling.
- When hand soldering, apply the soldering iron to the printed circuit board only. Temperature of the iron tip should not exceed 350°C. Soldering time should not exceed 3 seconds.

#### SHAPES AND DIMENSIONS/RECOMMENDED PC BOARD PATTERN

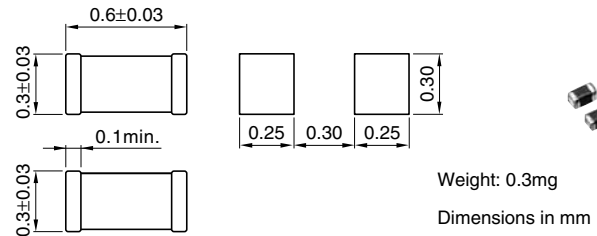

#### SPECIFICATIONS

|                             |                            |
|-----------------------------|----------------------------|
| Operating temperature range | -55 to +125°C              |
| Storage temperature range   | -55 to +125°C(After mount) |

#### PACKAGING STYLE AND QUANTITIES

|                 |                   |
|-----------------|-------------------|
| Packaging style | Quantity          |
| Taping          | 15000 pieces/reel |

#### RECOMMENDED SOLDERING CONDITION

##### REFLOW SOLDERING

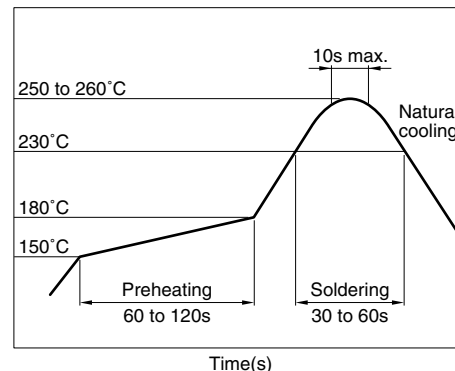

#### ELECTRICAL CHARACTERISTICS

| Part No.     | Impedance<br>(Ω)[100MHz]* | DC resistance<br>(Ω)max. | Rated current<br>(mA)max. |
|--------------|---------------------------|--------------------------|---------------------------|
| MPZ0603S220C | 22±25%                    | 0.065                    | 1000                      |
| MPZ0603S330C | 33±25%                    | 0.090                    | 750                       |
| MPZ0603S470C | 47±25%                    | 0.120                    | 500                       |

\* Test equipment: E4991A or equivalent  
Test tool: 16197 or equivalent  
Test temperature: 25±10°C

• Conformity to RoHS Directive: This means that, in conformity with EU Directive 2002/95/EC, lead, cadmium, mercury, hexavalent chromium, and specific bromine-based flame retardants, PBB and PBDE, have not been used, except for exempted applications.

• Please contact our Sales office when your application is considered the following:  
The device's failure or malfunction may directly endanger human life (e.g. application for automobile/aircraft/medical/nuclear power devices, etc.)

• All specifications are subject to change without notice.

### TYPICAL ELECTRICAL CHARACTERISTICS Z FREQUENCY CHARACTERISTICS MPZ0603S SERIES

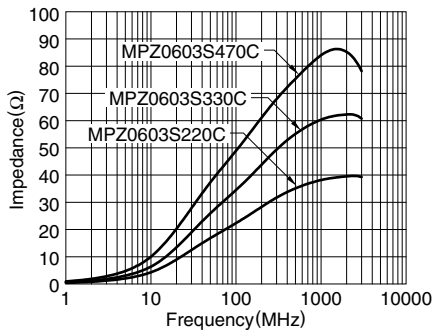

### Z, X, R vs. FREQUENCY CHARACTERISTICS MPZ0603S220C



### MPZ0603S330C

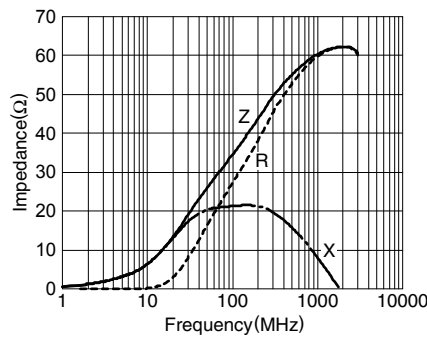

### MPZ0603S470C

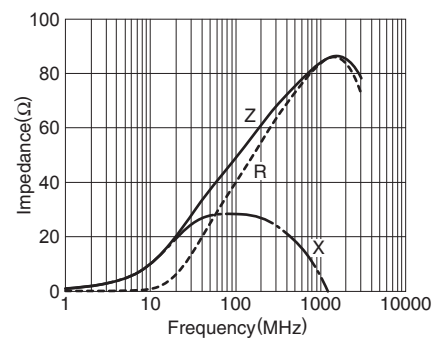

### PACKAGING STYLES REEL DIMENSIONS

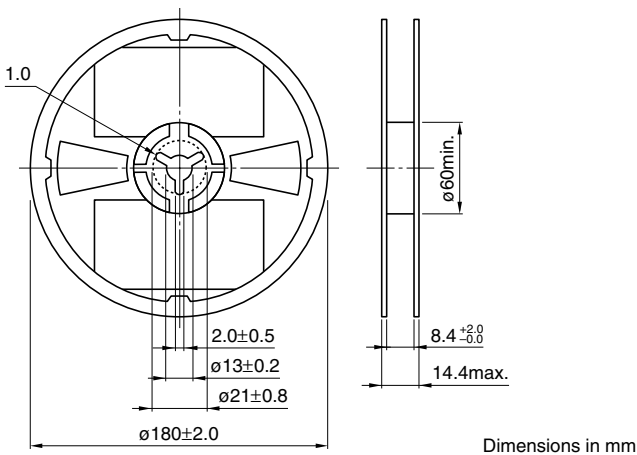

### TAPE DIMENSIONS

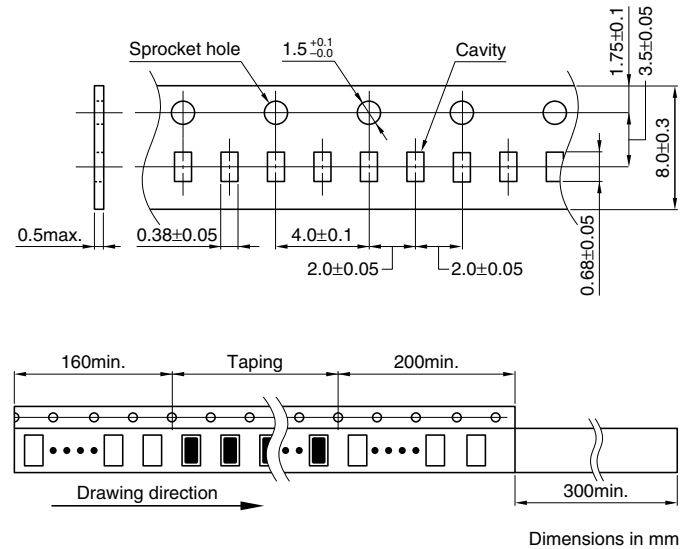

• All specifications are subject to change without notice.

# Chip Beads

## For Power Line

Conformity to RoHS Directive

### MPZ Series MPZ1005

#### FEATURES

- TDK has manufactured MPZ1005 type as EMI countermeasure product for power line.
- This type is the best for energy-saving in the low DC resistance.
- No cross talk with closed magnetic circuit structural design.
- It is a product conforming to RoHS directive.

#### APPLICATIONS

Removal of power line noises of cellular phones, PCs, note PCs, TVs, TV tuners, STBs, audio players, DVDs, DSCs, DVCs, game machines, digital photo frames, car navigation system, PNDs, etc.

#### PRODUCT IDENTIFICATION

|     |      |     |     |     |     |     |
|-----|------|-----|-----|-----|-----|-----|
| MPZ | 1005 | S   | 121 | C   | T   | □□□ |
| (1) | (2)  | (3) | (4) | (5) | (6) | (7) |

- (1) Series name
- (2) Dimensions L×W
- (3) Type name
- (4) Impedance  
121: 120Ω at 100MHz
- (5) Characteristic type
- (6) Packaging style  
T:Taping(reel)
- (7) TDK internal code

#### HANDLING AND PRECAUTIONS

- Before soldering, be sure to preheat components. The preheating temperature should be set so that the temperature difference between the solder temperature and product temperature does not exceed 150°C.
- After mounting components onto the printed circuit board, do not apply stress through board bending or mishandling.
- Do not expose the inductors to stray magnetic fields.
- Avoid static electricity discharge during handling.
- When hand soldering, apply the soldering iron to the printed circuit board only. Temperature of the iron tip should not exceed 350°C. Soldering time should not exceed 3 seconds.

#### SHAPES AND DIMENSIONS/RECOMMENDED PC BOARD PATTERN

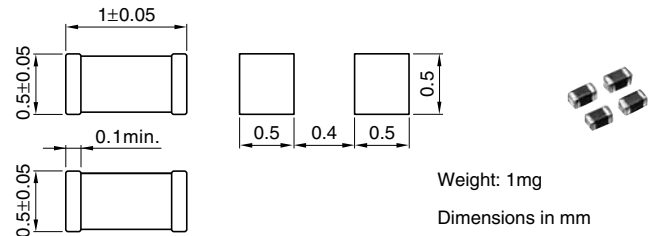

#### SPECIFICATIONS

|                             |                           |
|-----------------------------|---------------------------|
| Operating temperature range | -40 to +85°C              |
| Storage temperature range   | -40 to +85°C(After mount) |

#### PACKAGING STYLE AND QUANTITIES

|                 |                   |
|-----------------|-------------------|
| Packaging style | Quantity          |
| Taping          | 10000 pieces/reel |

#### RECOMMENDED SOLDERING CONDITION

##### REFLOW SOLDERING



#### ELECTRICAL CHARACTERISTICS

| Part No.     | Impedance (Ω)[100MHz]* | DC resistance (Ω)max. | Rated current (A)max. |
|--------------|------------------------|-----------------------|-----------------------|
| MPZ1005S100C | 10±5Ω                  | 0.025                 | 2.0                   |
| MPZ1005S300C | 30±10Ω                 | 0.035                 | 1.7                   |
| MPZ1005S600C | 60±25%                 | 0.060                 | 1.5                   |
| MPZ1005S121C | 120±25%                | 0.090                 | 1.2                   |
| MPZ1005Y900C | 90±25%                 | 0.100                 | 1.2                   |

\* Test equipment: E4991A or equivalent  
 Test tool: 16192A or equivalent  
 Test temperature: 25±10°C

• Conformity to RoHS Directive: This means that, in conformity with EU Directive 2002/95/EC, lead, cadmium, mercury, hexavalent chromium, and specific bromine-based flame retardants, PBB and PBDE, have not been used, except for exempted applications.

• Please contact our Sales office when your application is considered the following:  
 The device's failure or malfunction may directly endanger human life (e.g. application for automobile/aircraft/medical/nuclear power devices, etc.)

• All specifications are subject to change without notice.

### TYPICAL ELECTRICAL CHARACTERISTICS Z FREQUENCY CHARACTERISTICS MPZ1005S/MPZ1005Y SERIES



### Z, X, R vs. FREQUENCY CHARACTERISTICS MPZ1005S100C



### MPZ1005S300C



### MPZ1005S600C

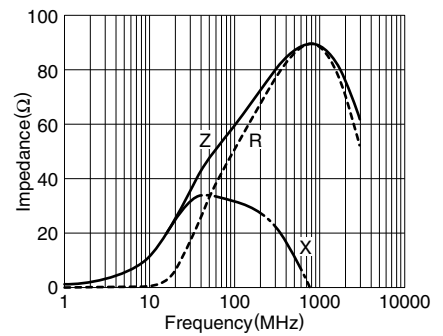

### MPZ1005S121C



### MPZ1005Y900C



### PACKAGING STYLES REEL DIMENSIONS



### TAPE DIMENSIONS



• All specifications are subject to change without notice.

# Chip Beads

## For Power Line

Conformity to RoHS Directive

### MPZ Series MPZ1608

#### FEATURES

- This type is the best for energy-saving in the low DC resistance.
- The products contain no lead and also support lead-free soldering.
- It is a product conforming to RoHS directive.

#### APPLICATIONS

Removal of power line noises of cellular phones, PCs, note PCs, TVs, TV tuners, STBs, audio players, DVDs, DSCs, DVCs, game machines, digital photo frames, car navigation system, PNDs, etc.

#### PRODUCT IDENTIFICATION

|     |      |     |     |     |     |     |
|-----|------|-----|-----|-----|-----|-----|
| MPZ | 1608 | S   | 221 | A   | T   | □□□ |
| (1) | (2)  | (3) | (4) | (5) | (6) | (7) |

- (1) Series name
- (2) Dimensions L×W
- (3) Type name
- (4) Impedance  
221: 220Ω at 100MHz
- (5) Characteristic type
- (6) Packaging style  
T: Taping
- (7) TDK internal code

#### HANDLING AND PRECAUTIONS

- Before soldering, be sure to preheat components. The preheating temperature should be set so that the temperature difference between the solder temperature and product temperature does not exceed 150°C.
- After mounting components onto the printed circuit board, do not apply stress through board bending or mishandling.
- Do not expose the inductors to stray magnetic fields.
- Avoid static electricity discharge during handling.
- When hand soldering, apply the soldering iron to the printed circuit board only. Temperature of the iron tip should not exceed 350°C. Soldering time should not exceed 3 seconds.

#### MATERIAL CHARACTERISTICS

**B material:** This type is perfectly suited for fast digital signals. By equalizing R components and X components that beads possess at a frequency of 5MHz, it is able to suppress overshooting, undershooting and ringing of fast digital signals.

**R material:** For wide frequency applications calling for broad impedance characteristics.

For digital signal line applications calling requiring good waveform integrity. Impedance values selected for effectiveness at 10 to 200MHz.

**S material:** Standard type that features impedance characteristics similar to those of a typical ferrite core.

For signal line applications in which the blocking region is near 100MHz. Impedance values selected for effectiveness at 40 to 300MHz.

**Y material:** High frequency range type intended for the 100MHz region and above.

For signal line applications in which the signal frequency is far from the cutoff frequency. Impedance values selected for effectiveness at 80 to 400MHz.

**D material:** For applications calling for low insertion loss at low frequencies and sharply increasing impedance at high frequencies. Designed for high impedance at high frequencies (300MHz to 1GHz) for signal line applications.

#### TYPICAL MATERIAL CHARACTERISTICS

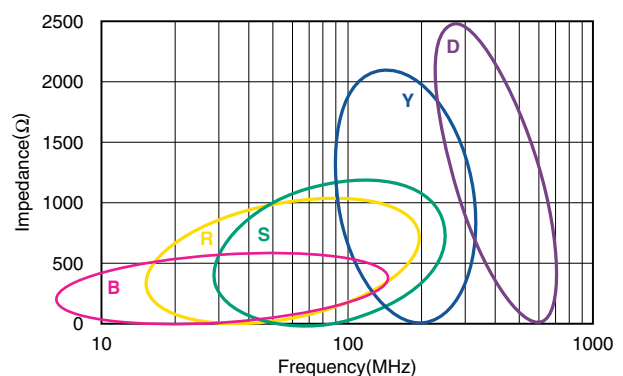

• Conformity to RoHS Directive: This means that, in conformity with EU Directive 2002/95/EC, lead, cadmium, mercury, hexavalent chromium, and specific bromine-based flame retardants, PBB and PBDE, have not been used, except for exempted applications.

• Please contact our Sales office when your application is considered the following:  
The device's failure or malfunction may directly endanger human life (e.g. application for automobile/aircraft/medical/nuclear power devices, etc.)

• All specifications are subject to change without notice.

## SHAPES AND DIMENSIONS/RECOMMENDED PC BOARD PATTERN



| Thickness(T) | Weight |
|--------------|--------|
| 0.6±0.15mm   | 3mg    |
| 0.8±0.15mm   | 4mg    |

## SPECIFICATIONS

|                             |                            |
|-----------------------------|----------------------------|
| Operating temperature range | -55 to +125°C              |
| Storage temperature range   | -55 to +125°C(After mount) |

## PACKAGING STYLE AND QUANTITIES

|                 |                  |
|-----------------|------------------|
| Packaging style | Quantity         |
| Taping          | 4000 pieces/reel |

## RECOMMENDED SOLDERING CONDITION REFLOW SOLDERING

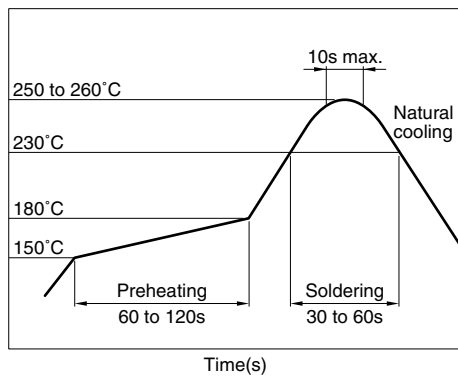

## ELECTRICAL CHARACTERISTICS

| Part No.     | Impedance<br>( $\Omega$ )[100MHz]*1 | DC resistance<br>( $\Omega$ )max. | Rated current*2<br>(A)max. | Thickness<br>T(mm) |
|--------------|-------------------------------------|-----------------------------------|----------------------------|--------------------|
| MPZ1608B471A | 470±25%                             | 0.150                             | 1.0                        | 0.8                |
| MPZ1608S300A | 30±10 $\Omega$                      | 0.010                             | 5.0                        | 0.6                |
| MPZ1608S600A | 60±25%                              | 0.020                             | 3.5                        | 0.6                |
| MPZ1608S101A | 100±25%                             | 0.030                             | 3.0                        | 0.6                |
| MPZ1608S121A | 120±25%                             | 0.045                             | 2.0                        | 0.6                |
| MPZ1608S181A | 180±25%                             | 0.050                             | 2.0                        | 0.6                |
| MPZ1608S221A | 220±25%                             | 0.050                             | 2.2                        | 0.8                |
| MPZ1608S331A | 330±25%                             | 0.080                             | 1.7                        | 0.8                |
| MPZ1608R391A | 390±25%                             | 0.120                             | 1.2                        | 0.8                |
| MPZ1608S471A | 470±25%                             | 0.150                             | 1.0                        | 0.8                |
| MPZ1608S601A | 600±25%                             | 0.150                             | 1.0                        | 0.8                |
| MPZ1608S102A | 1000±25%                            | 0.300                             | 0.8                        | 0.8                |
| MPZ1608Y600B | 60±25%                              | 0.030                             | 2.3                        | 0.8                |
| MPZ1608Y101B | 100±25%                             | 0.040                             | 2.0                        | 0.8                |
| MPZ1608Y151B | 150±25%                             | 0.050                             | 1.8                        | 0.8                |
| MPZ1608Y221B | 220±25%                             | 0.100                             | 1.5                        | 0.8                |
| MPZ1608D300B | 30±10 $\Omega$                      | 0.060                             | 1.8                        | 0.8                |
| MPZ1608D600B | 60±25%                              | 0.100                             | 1.2                        | 0.8                |
| MPZ1608D101B | 100±25%                             | 0.150                             | 1.0                        | 0.8                |

\*1 Test equipment: E4991A or equivalent  
Test tool: 16192A or equivalent  
Test temperature: 25±10°C

\*2 Please refer to the graph of RATED CURRENT vs. TEMPERATURE CHARACTERISTICS(DERATING) about the rating current at 85°C or more in temperature of the product.

## RATED CURRENT vs. TEMPERATURE CHARACTERISTICS (DERATING)



|                               |                     |                   |         |
|-------------------------------|---------------------|-------------------|---------|
| — S300A                       | — S600A             | — S101A           | — Y600B |
| — S221A                       | — S121A,S181A,Y101B | — Y151B,D300B     |         |
| - - - S331A                   | - - - Y221B         | - - - R391A,D600B |         |
| - - - B471A,S471A,S601A,D101B | - - - S102A         |                   |         |

**TYPICAL ELECTRICAL CHARACTERISTICS**

**Z, X, R vs. FREQUENCY CHARACTERISTICS**

**MPZ1608B471A**

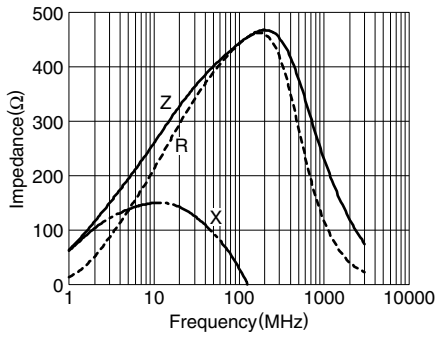

**MPZ1608S300A**

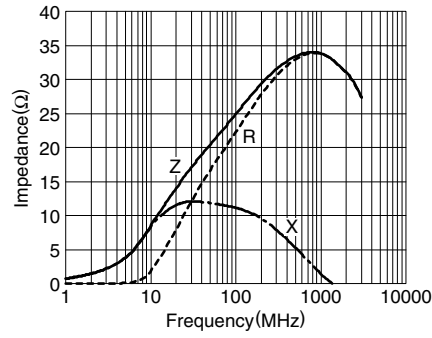

**MPZ1608S600A**

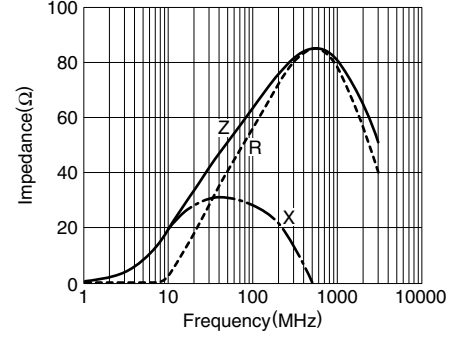

**MPZ1608S101A**

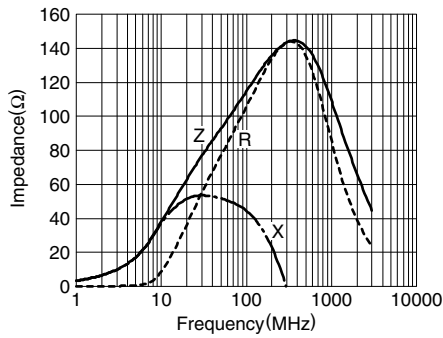

**MPZ1608S121A**

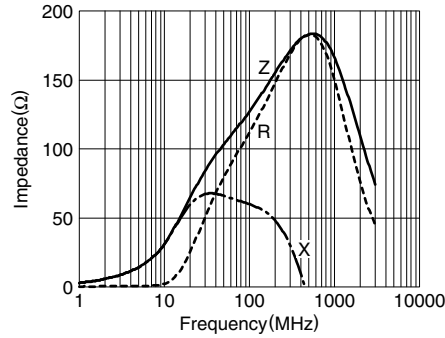

**MPZ1608S181A**

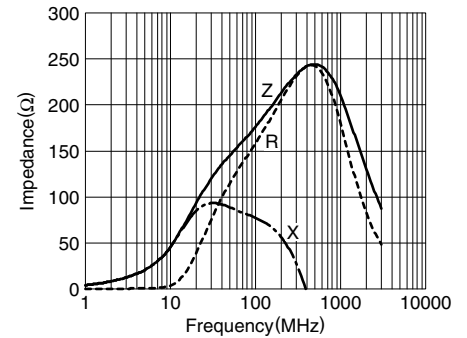

**MPZ1608S221A**

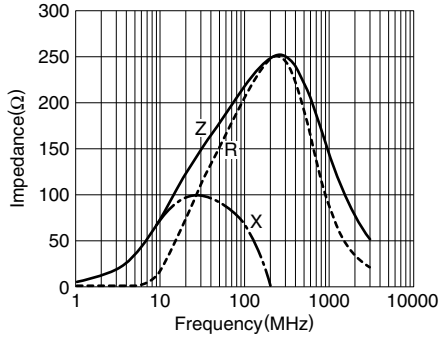

**MPZ1608S331A**

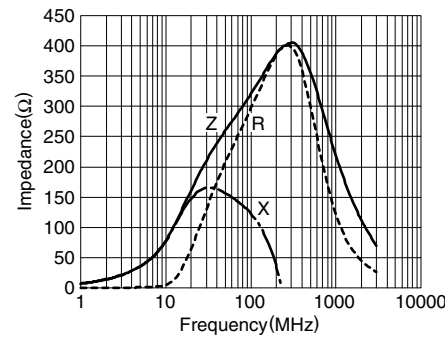

**MPZ1608R391A**

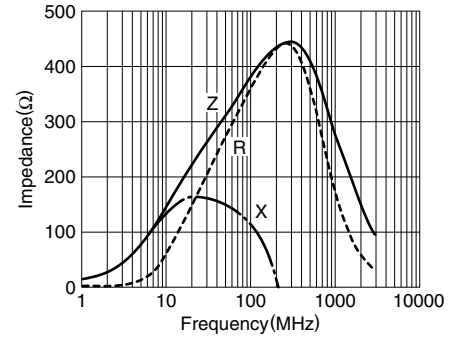

**MPZ1608S471A**

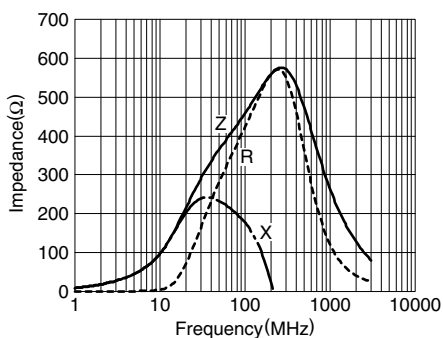

**MPZ1608S601A**

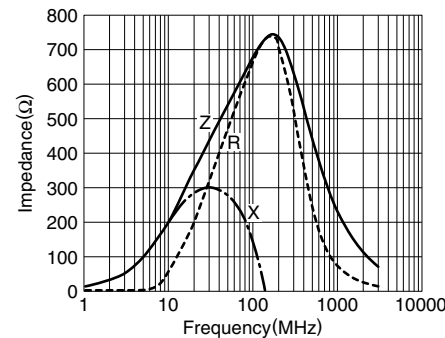

**MPZ1608S102A**

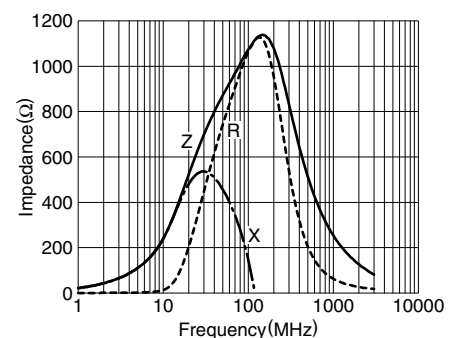

• All specifications are subject to change without notice.





# Chip Beads

## For Power Line

Conformity to RoHS Directive

### MPZ Series MPZ2012

#### FEATURES

- The MPZ series are multilayer chip impeders for power supply line applications.
- High miniaturized, these parts nonetheless exhibit low DC resistance and high current handling capability.
- The products contain no lead and also support lead-free soldering.
- It is a product conforming to RoHS directive.

#### APPLICATIONS

Removal of power line noises of cellular phones, PCs, note PCs, TVs, TV tuners, STBs, audio players, DVDs, DSCs, DVCs, game machines, digital photo frames, car navigation system, PNDs, etc.

#### PRODUCT IDENTIFICATION

MPZ 2012 S 331 A T □□□  
 (1) (2) (3) (4) (5) (6) (7)

(1) Series name

(2) Dimensions L×W

(3) Type name

(4) Impedance

331: 330Ω at 100MHz

(5) Characteristic type

(6) Packaging style

T: Taping

(7) TDK internal code

#### HANDLING AND PRECAUTIONS

- Before soldering, be sure to preheat components. The preheating temperature should be set so that the temperature difference between the solder temperature and product temperature does not exceed 150°C.
- After mounting components onto the printed circuit board, do not apply stress through board bending or mishandling.
- Do not expose the inductors to stray magnetic fields.
- Avoid static electricity discharge during handling.
- When hand soldering, apply the soldering iron to the printed circuit board only. Temperature of the iron tip should not exceed 350°C. Soldering time should not exceed 3 seconds.

#### SHAPES AND DIMENSIONS/RECOMMENDED PC BOARD PATTERN

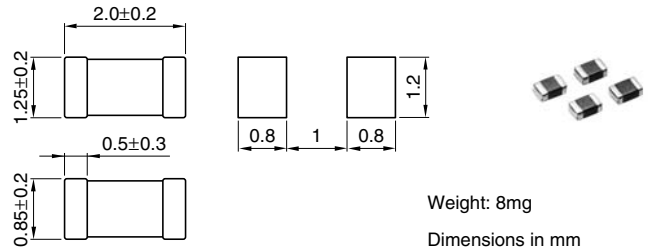

#### SPECIFICATIONS

|                             |                             |
|-----------------------------|-----------------------------|
| Operating temperature range | -55 to +125°C               |
| Storage temperature range   | -55 to +125°C (After mount) |

#### PACKAGING STYLE AND QUANTITIES

|                 |                  |
|-----------------|------------------|
| Packaging style | Quantity         |
| Taping          | 4000 pieces/reel |

#### RECOMMENDED SOLDERING CONDITION REFLOW SOLDERING

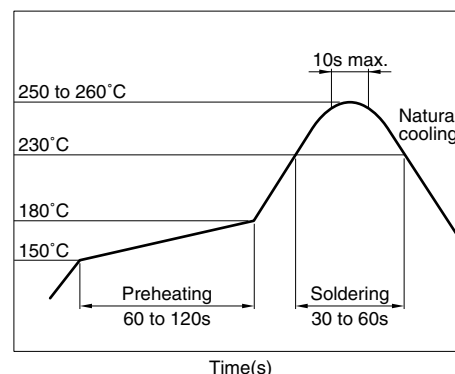

• Conformity to RoHS Directive: This means that, in conformity with EU Directive 2002/95/EC, lead, cadmium, mercury, hexavalent chromium, and specific bromine-based flame retardants, PBB and PBDE, have not been used, except for exempted applications.

• Please contact our Sales office when your application is considered the following:  
The device's failure or malfunction may directly endanger human life (e.g. application for automobile/aircraft/medical/nuclear power devices, etc.)

• All specifications are subject to change without notice.

**ELECTRICAL CHARACTERISTICS**

| Part No.     | Impedance (Ω)[100MHz] <sup>*1</sup> | DC resistance (Ω)max. | Rated current <sup>*2</sup> (A)max. |
|--------------|-------------------------------------|-----------------------|-------------------------------------|
| MPZ2012S300A | 30±10Ω                              | 0.010                 | 6                                   |
| MPZ2012S101A | 100±25%                             | 0.020                 | 4                                   |
| MPZ2012S221A | 220±25%                             | 0.040                 | 3                                   |
| MPZ2012S331A | 330±25%                             | 0.050                 | 2.5                                 |
| MPZ2012S601A | 600±25%                             | 0.100                 | 2                                   |
| MPZ2012S102A | 1000±25%                            | 0.150                 | 1.5                                 |

<sup>\*1</sup> Test equipment: E4991A or equivalent  
 Test tool: 16192A or equivalent  
 Test temperature: 25±10°C

<sup>\*2</sup> Please refer to the graph of RATED CURRENT vs. TEMPERATURE CHARACTERISTICS(DERATING) about the rating current at 85°C or more in temperature of the product.

**RATED CURRENT vs. TEMPERATURE CHARACTERISTICS (DERATING)**



**TYPICAL ELECTRICAL CHARACTERISTICS Z, X, R vs. FREQUENCY CHARACTERISTICS**

**MPZ2012S300A**



**MPZ2012S101A**

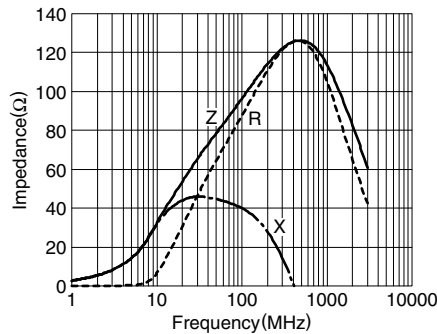

**MPZ2012S221A**

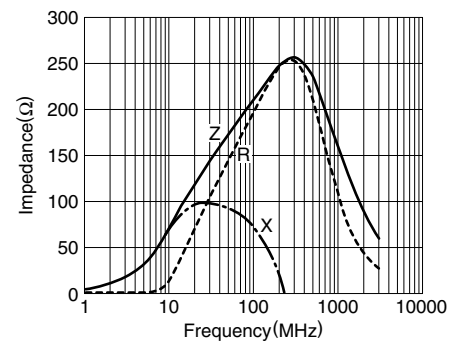

**MPZ2012S331A**

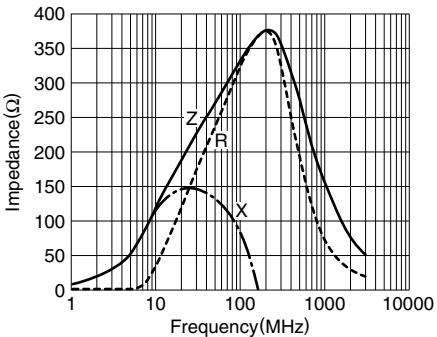

**MPZ2012S601A**

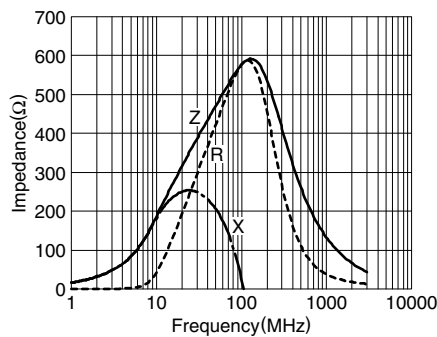

**MPZ2012S102A**

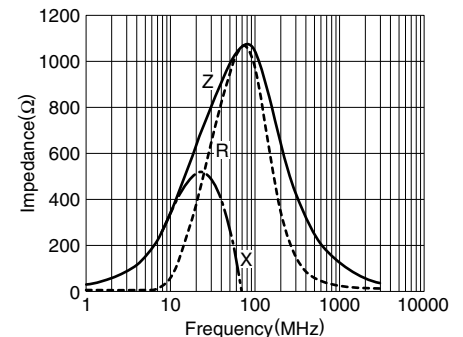

**PACKAGING STYLES**

**REEL DIMENSIONS**



**TAPE DIMENSIONS**

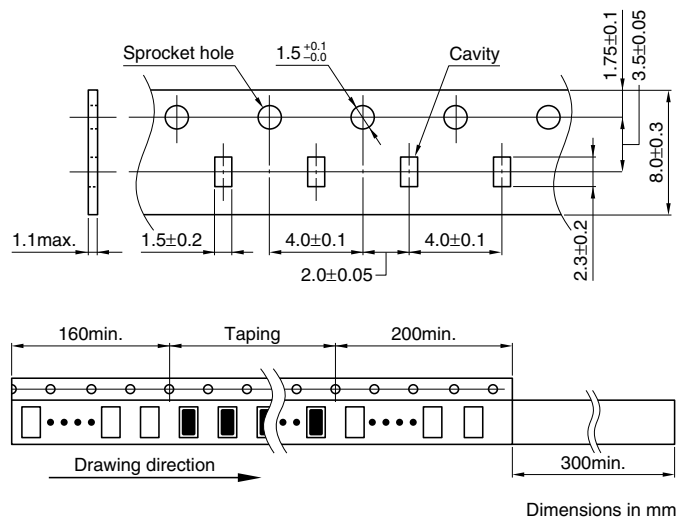

• All specifications are subject to change without notice.

# Chip Beads

## For Power Line

Conformity to RoHS Directive

### MPZ Series MPZ1005-E

#### FEATURES

- TDK has manufactured MPZ1005 type as EMI countermeasure product for power line.
- Compared with the existing MPZ1005 type, this new product has broad-band impedance values for higher frequency ranges.
- This type is the best for energy-saving in the low DC resistance.
- No cross talk with closed magnetic circuit structural design.
- It is a product conforming to RoHS directive.

#### APPLICATIONS

Removal of power line noises of cellular phones, PCs, note PCs, TVs, TV tuners, STBs, audio players, DVDs, DSCs, DVCs, game machines, digital photo frames, PNDs, etc.

#### PRODUCT IDENTIFICATION

|     |      |     |     |     |     |                          |                          |                          |
|-----|------|-----|-----|-----|-----|--------------------------|--------------------------|--------------------------|
| MPZ | 1005 | S   | 221 | E   | T   | <input type="checkbox"/> | <input type="checkbox"/> | <input type="checkbox"/> |
| (1) | (2)  | (3) | (4) | (5) | (6) | (7)                      |                          |                          |

- (1) Series name
- (2) Dimensions L×W
- (3) Type name
- (4) Impedance  
221:220Ω at 100MHz
- (5) Characteristic type
- (6) Packaging style  
T:Taping(reel)
- (7) TDK internal code

#### HANDLING AND PRECAUTIONS

- Before soldering, be sure to preheat components. The preheating temperature should be set so that the temperature difference between the solder temperature and product temperature does not exceed 150°C.
- After mounting components onto the printed circuit board, do not apply stress through board bending or mishandling.
- Do not expose the inductors to stray magnetic fields.
- Avoid static electricity discharge during handling.
- When hand soldering, apply the soldering iron to the printed circuit board only. Temperature of the iron tip should not exceed 350°C. Soldering time should not exceed 3 seconds.

#### SHAPES AND DIMENSIONS/RECOMMENDED PC BOARD PATTERN



#### SPECIFICATIONS

|                             |                            |
|-----------------------------|----------------------------|
| Operating temperature range | -55 to +125°C              |
| Storage temperature range   | -55 to +125°C(After mount) |

#### PACKAGING STYLE AND QUANTITIES

|                 |                   |
|-----------------|-------------------|
| Packaging style | Quantity          |
| Taping          | 10000 pieces/reel |

#### RECOMMENDED SOLDERING CONDITION

##### REFLOW SOLDERING

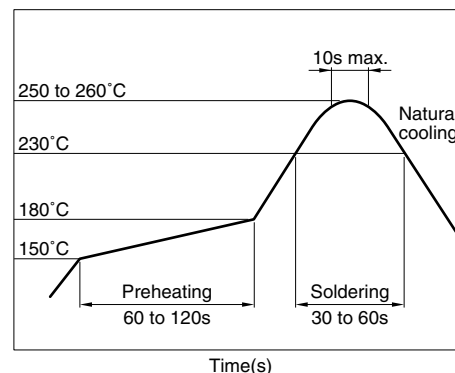

• Conformity to RoHS Directive: This means that, in conformity with EU Directive 2002/95/EC, lead, cadmium, mercury, hexavalent chromium, and specific bromine-based flame retardants, PBB and PBDE, have not been used, except for exempted applications.

• Please contact our Sales office when your application is considered the following:  
The device's failure or malfunction may directly endanger human life (e.g. application for automobile/aircraft/medical/nuclear power devices, etc.)

• All specifications are subject to change without notice.

### ELECTRICAL CHARACTERISTICS

| Part No.     | Impedance( $\Omega$ )*1 |               | DC resistance<br>( $\Omega$ )max. | Rated current<br>(A)max.*2 |
|--------------|-------------------------|---------------|-----------------------------------|----------------------------|
|              | [100MHz]                | [1GHz]        |                                   |                            |
| MPZ1005S221E | 220 $\pm$ 25%           | 350 $\pm$ 40% | 0.22                              | 0.9                        |
| MPZ1005S331E | 330 $\pm$ 25%           | 550 $\pm$ 40% | 0.28                              | 0.7                        |

\*1 Test equipment: E4991A or equivalent  
 Test tool: 16192A or equivalent  
 Test temperature: 25 $\pm$ 10°C

\*2 Please refer to the graph of RATED CURRENT vs. TEMPERATURE CHARACTERISTICS(DERATING) about the rating current at 85°C or more in temperature of the product.

### RATED CURRENT vs. TEMPERATURE CHARACTERISTICS (DERATING)



### TYPICAL ELECTRICAL CHARACTERISTICS Z FREQUENCY CHARACTERISTICS MPZ1005S-E SERIES



### Z, X, R vs. FREQUENCY CHARACTERISTICS MPZ1005S221E



### MPZ1005S331E



### PACKAGING STYLES REEL DIMENSIONS



### TAPE DIMENSIONS



• All specifications are subject to change without notice.

Компания «Океан Электроники» предлагает заключение долгосрочных отношений при поставках импортных электронных компонентов на взаимовыгодных условиях!

Наши преимущества:

- Поставка оригинальных импортных электронных компонентов напрямую с производств Америки, Европы и Азии, а так же с крупнейших складов мира;
- Широкая линейка поставок активных и пассивных импортных электронных компонентов (более 30 млн. наименований);
- Поставка сложных, дефицитных, либо снятых с производства позиций;
- Оперативные сроки поставки под заказ (от 5 рабочих дней);
- Экспресс доставка в любую точку России;
- Помощь Конструкторского Отдела и консультации квалифицированных инженеров;
- Техническая поддержка проекта, помощь в подборе аналогов, поставка прототипов;
- Поставка электронных компонентов под контролем ВП;
- Система менеджмента качества сертифицирована по Международному стандарту ISO 9001;
- При необходимости вся продукция военного и аэрокосмического назначения проходит испытания и сертификацию в лаборатории (по согласованию с заказчиком);
- Поставка специализированных компонентов военного и аэрокосмического уровня качества (Xilinx, Altera, Analog Devices, Intersil, Interpoint, Microsemi, Actel, Aeroflex, Peregrine, VPT, Syfer, Eurofarad, Texas Instruments, MS Kennedy, Miteq, Cobham, E2V, MA-COM, Hittite, Mini-Circuits, General Dynamics и др.);

Компания «Океан Электроники» является официальным дистрибьютором и эксклюзивным представителем в России одного из крупнейших производителей разъемов военного и аэрокосмического назначения «JONHON», а так же официальным дистрибьютором и эксклюзивным представителем в России производителя высокотехнологичных и надежных решений для передачи СВЧ сигналов «FORSTAR».



## JONHON

«JONHON» (основан в 1970 г.)

Разъемы специального, военного и аэрокосмического назначения:

(Применяются в военной, авиационной, аэрокосмической, морской, железнодорожной, горно- и нефтедобывающей отраслях промышленности)

«FORSTAR» (основан в 1998 г.)

ВЧ соединители, коаксиальные кабели, кабельные сборки и микроволновые компоненты:

(Применяются в телекоммуникациях гражданского и специального назначения, в средствах связи, РЛС, а так же военной, авиационной и аэрокосмической отраслях промышленности).



Телефон: 8 (812) 309-75-97 (многоканальный)

Факс: 8 (812) 320-03-32

Электронная почта: [ocean@oceanchips.ru](mailto:ocean@oceanchips.ru)

Web: <http://oceanchips.ru/>

Адрес: 198099, г. Санкт-Петербург, ул. Калинина, д. 2, корп. 4, лит. А