



## WIDE BANDWIDTH QUAD J-FET OPERATIONAL AMPLIFIERS

- LOW POWER CONSUMPTION
- WIDE COMMON-MODE (UP TO  $V_{CC}^+$ ) AND DIFFERENTIAL VOLTAGE RANGE
- LOW INPUT BIAS AND OFFSET CURRENT
- OUTPUT SHORT-CIRCUIT PROTECTION
- HIGH INPUT IMPEDANCE J-FET INPUT STAGE
- INTERNAL FREQUENCY COMPENSATION
- LATCH UP FREE OPERATION
- HIGH SLEW RATE : 16V/ $\mu$ s (typ)



### DESCRIPTION

These circuits are high speed J-FET input quad operational amplifiers incorporating well matched, high voltage J-FET and bipolar transistors in a monolithic integrated circuit.

The devices feature high slew rates, low input bias and offset currents, and low offset voltage temperature coefficient.

### ORDER CODE

Part Number	Temperature Range	Package	
		N	D
LF147	-55°C, +125°C	•	•
LF247	-40°C, +105°C	•	•
LF347	0°C, +70°C	•	•

**Example : LF347IN**

N = Dual in Line Package (DIP)  
D = Small Outline Package (SO) - also available in Tape & Reel (DT)

### PIN CONNECTIONS (top view)

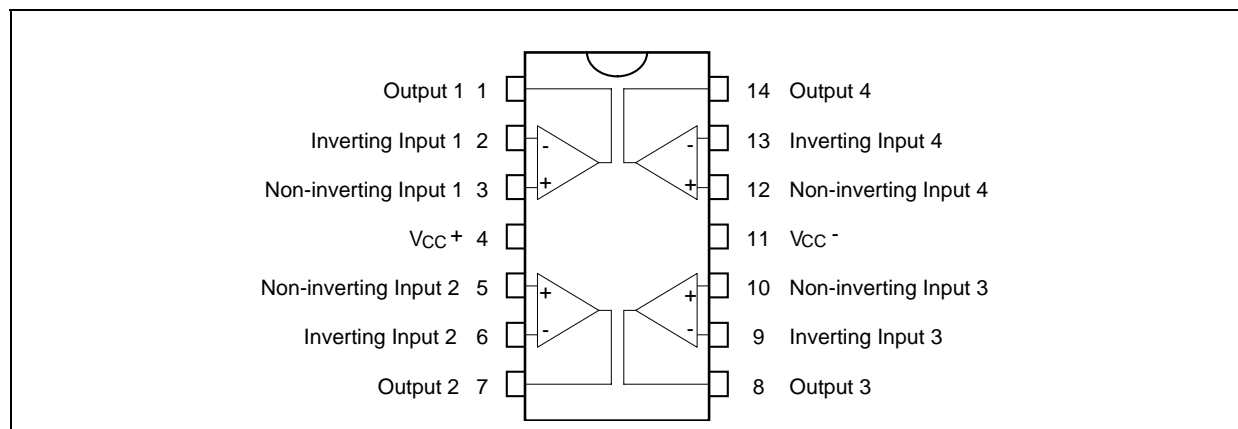

**SCHEMATIC DIAGRAM** (each amplifier)

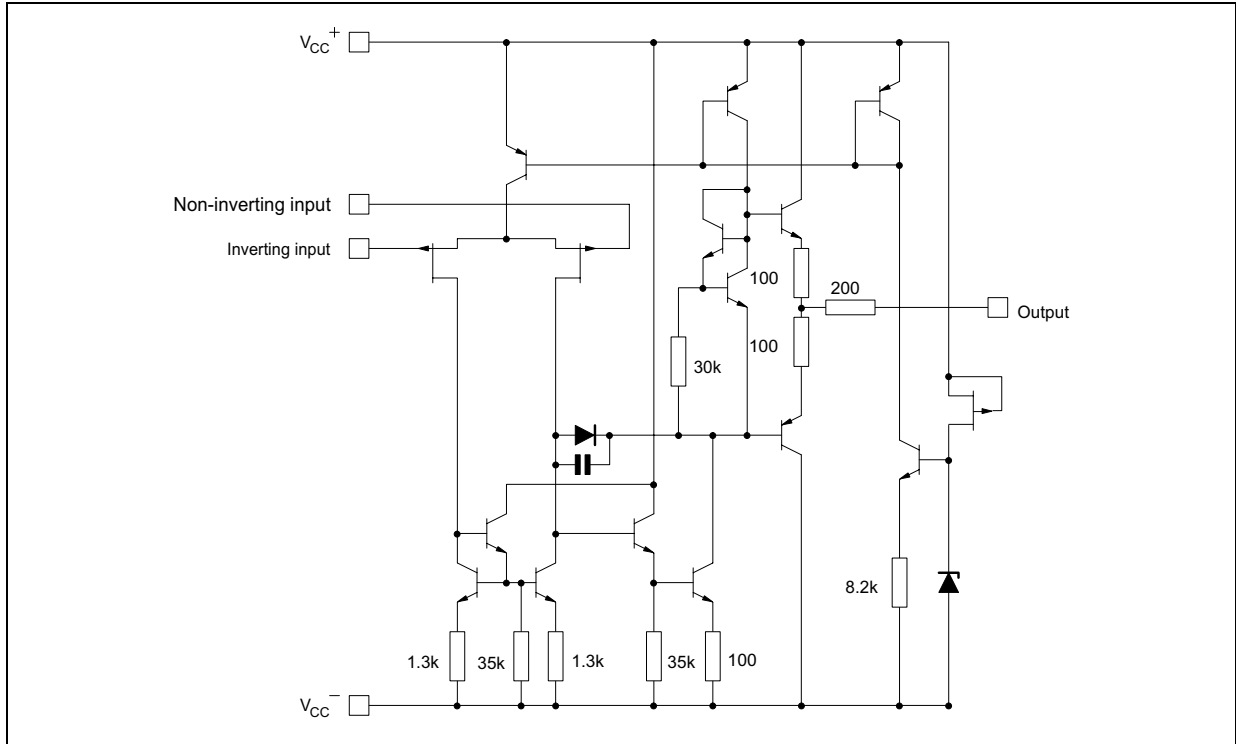

**ABSOLUTE MAXIMUM RATINGS**

Symbol	Parameter	LF147	LF247	LF347	Unit
$V_{CC}$	Supply voltage - note <sup>1)</sup>	$\pm 18$			V
$V_i$	Input Voltage - note <sup>2)</sup>	$\pm 15$			V
$V_{id}$	Differential Input Voltage - note <sup>3)</sup>	$\pm 30$			V
$P_{tot}$	Power Dissipation	680			mW
	Output Short-circuit Duration - note <sup>4)</sup>	Infinite			
$T_{oper}$	Operating Free-air Temperature Range	-55 to +125	-40 to +105	0 to +70	°C
$T_{stg}$	Storage Temperature Range	-65 to +150			°C

1. All voltage values, except differential voltage, are with respect to the zero reference level (ground) of the supply voltages where the zero reference level is the midpoint between  $V_{CC+}$  and  $V_{CC-}$ .
2. The magnitude of the input voltage must never exceed the magnitude of the supply voltage or 15 volts, whichever is less.
3. Differential voltages are the non-inverting input terminal with respect to the inverting input terminal.
4. The output may be shorted to ground or to either supply. Temperature and/or supply voltages must be limited to ensure that the dissipation rating is not exceeded

**ELECTRICAL CHARACTERISTICS**

$V_{CC} = \pm 15V$ ,  $T_{amb} = +25^{\circ}C$  (unless otherwise specified)

Symbol	Parameter	Min.	Typ.	Max.	Unit
$V_{io}$	Input Offset Voltage ( $R_S = 10k\Omega$ ) $T_{amb} = 25^{\circ}C$ $T_{min} \leq T_{amb} \leq T_{max}$		3	10 13	mV
$DV_{io}$	Input Offset Voltage Drift		10		$\mu V/^{\circ}C$
$I_{io}$	Input Offset Current - note 1) $T_{amb} = 25^{\circ}C$ $T_{min} \leq T_{amb} \leq T_{max}$		5	100 4	pA nA
$I_{ib}$	Input Bias Current - note 1 $T_{amb} = 25^{\circ}C$ $T_{min} \leq T_{amb} \leq T_{max}$		20	200 20	pA nA
$A_{vd}$	Large Signal Voltage Gain ( $R_L = 2k\Omega$ , $V_O = \pm 10V$ ), $T_{amb} = 25^{\circ}C$ $T_{min} \leq T_{amb} \leq T_{max}$	50 25	200		V/mV
SVR	Supply Voltage Rejection Ratio ( $R_S = 10k\Omega$ ) $T_{amb} = 25^{\circ}C$ $T_{min} \leq T_{amb} \leq T_{max}$	80 80	86		dB
$I_{CC}$	Supply Current, Per Amp, no Load $T_{amb} = 25^{\circ}C$ $T_{min} \leq T_{amb} \leq T_{max}$		1.4	2.7 2.7	mA
$V_{icm}$	Input Common Mode Voltage Range	$\pm 11$	+15 -12		V
CMR	Common Mode Rejection Ratio ( $R_S = 10k\Omega$ ) $T_{amb} = 25^{\circ}C$ $T_{min} \leq T_{amb} \leq T_{max}$	70 70	86		dB
$I_{OS}$	Output Short-Circuit Current $T_{amb} = 25^{\circ}C$ $T_{min} \leq T_{amb} \leq T_{max}$	10 10	40	60 60	mA
$\pm V_{opp}$	Output Voltage Swing $T_{amb} = 25^{\circ}C$ $T_{min} \leq T_{amb} \leq T_{max}$	$R_L = 2k\Omega$ 10 $R_L = 10k\Omega$ 12 $R_L = 2k\Omega$ 10 $R_L = 10k\Omega$ 12	12 13.5		V
SR	Slew Rate $V_i = 10V$ , $R_L = 2k\Omega$ , $C_L = 100pF$ , $T_{amb} = 25^{\circ}C$ , unity gain	12	16		V/ $\mu s$
$t_r$	Rise Time $V_i = 20mV$ , $R_L = 2k\Omega$ , $C_L = 100pF$ , $T_{amb} = 25^{\circ}C$ , unity gain		0.1		$\mu s$
$K_{ov}$	Overshoot $V_i = 20mV$ , $R_L = 2k\Omega$ , $C_L = 100pF$ , $T_{amb} = 25^{\circ}C$ , unity gain		10		%
GBP	Gain Bandwidth Product $f = 100kHz$ , $T_{amb} = 25^{\circ}C$ , $V_{in} = 10mV$ , $R_L = 2k\Omega$ , $C_L = 100pF$	2.5	4		MHz
$R_i$	Input Resistance		$10^{12}$		$\Omega$
THD	Total Harmonic Distortion $f = 1kHz$ , $A_v = 20dB$ , $R_L = 2k\Omega$ , $C_L = 100pF$ $T_{amb} = 25^{\circ}C$ , $V_O = 2V_{pp}$		0.01		%
$e_n$	Equivalent Input Noise Voltage ( $R_S = 100\Omega$ , $f = 1kHz$ )		15		$\frac{nV}{\sqrt{Hz}}$
$\phi_m$	Phase Margin		45		Degrees
$V_{O1}/V_{O2}$	Channel Separation ( $A_v = 100$ )		120		dB

1. The input bias currents are junction leakage currents which approximately double for every 10°C increase in the junction temperature.

**MAXIMUM PEAK-TO-PEAK OUTPUT VOLTAGE versus FREQUENCY**

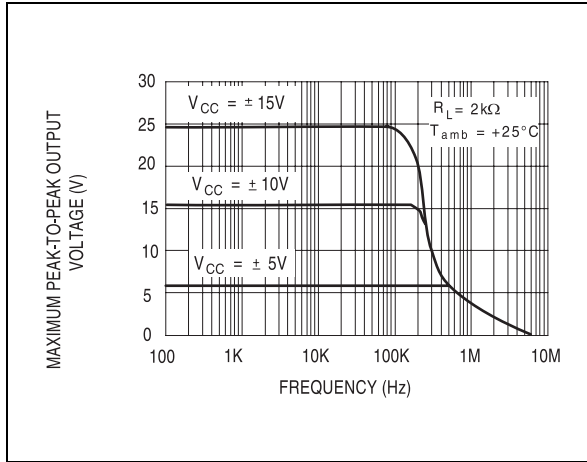

**MAXIMUM PEAK-TO-PEAK OUTPUT VOLTAGE versus FREQUENCY**

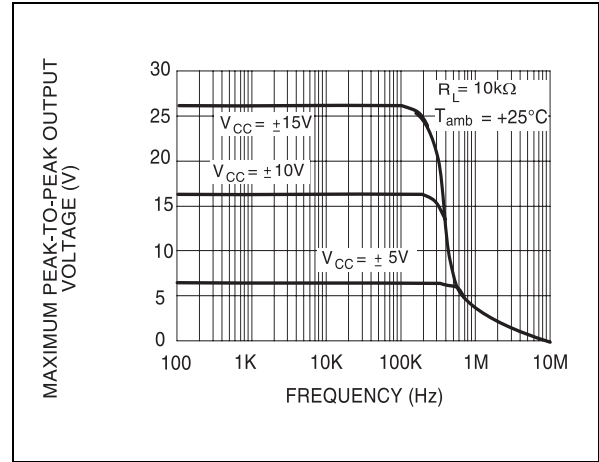

**MAXIMUM PEAK-TO-PEAK OUTPUT VOLTAGE versus FREQUENCY**

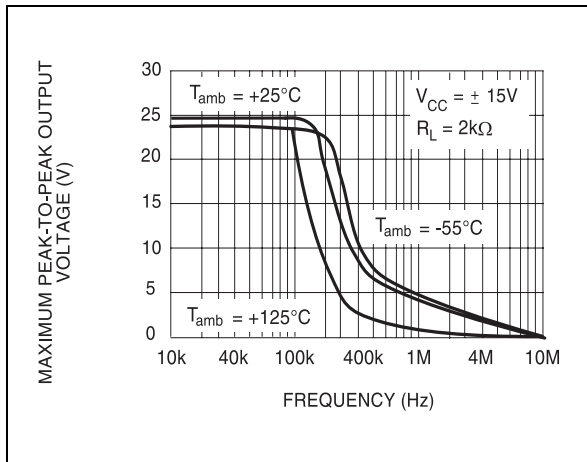

**MAXIMUM PEAK-TO-PEAK OUTPUT VOLTAGE versus FREE AIR TEMP.**

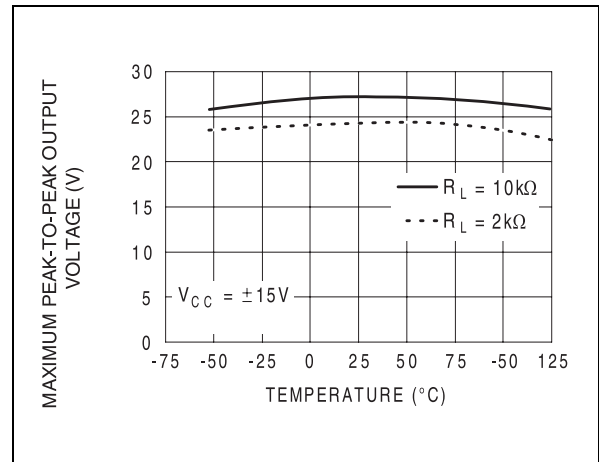

**MAXIMUM PEAK-TO-PEAK OUTPUT VOLTAGE versus LOAD RESISTANCE**

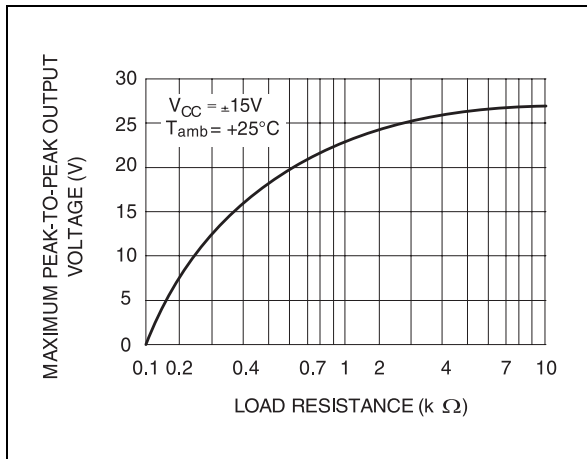

**MAXIMUM PEAK-TO-PEAK OUTPUT VOLTAGE versus SUPPLY VOLTAGE**

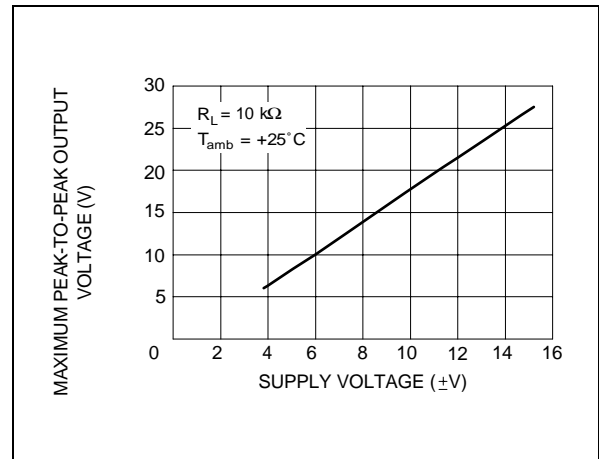

**INPUT BIAS CURRENT versus FREE AIR TEMPERATURE**

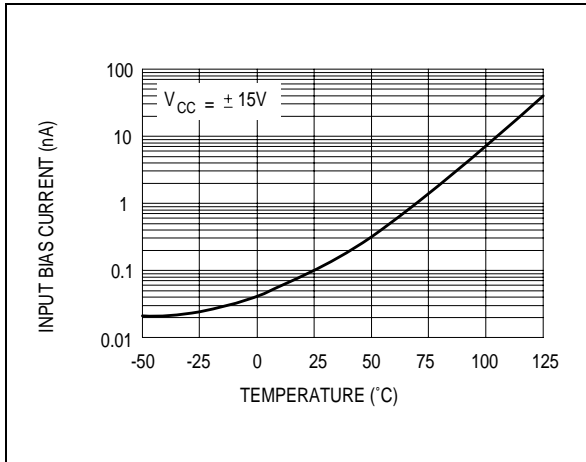

**LARGE SIGNAL DIFFERENTIAL VOLTAGE AMPLIFICATION AND PHASE SHIFT versus FREQUENCY**

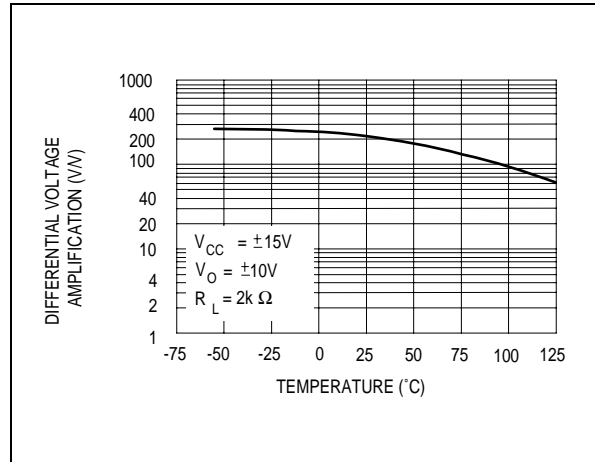

**LARGE SIGNAL DIFFERENTIAL VOLTAGE AMPLIFICATION AND PHASE SHIFT versus FREQUENCY**

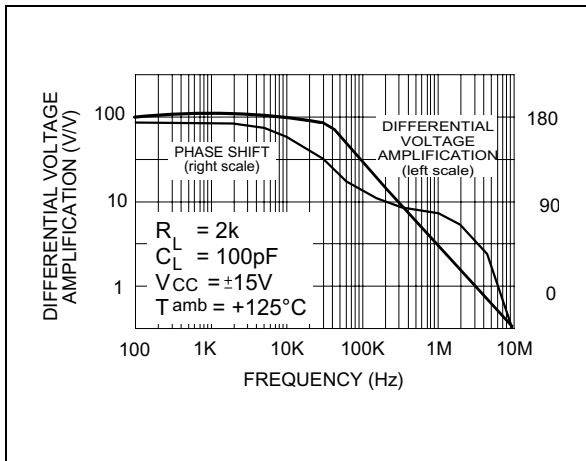

**TOTAL POWER DISSIPATION versus FREE AIR TEMPERATURE**

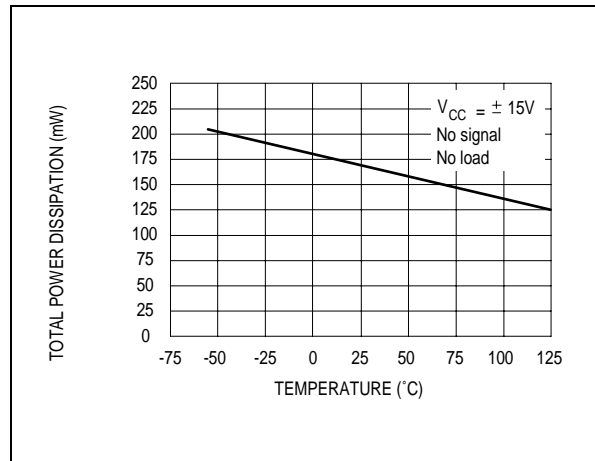

**SUPPLY CURRENT PER AMPLIFIER versus FREE AIR TEMPERATURE**

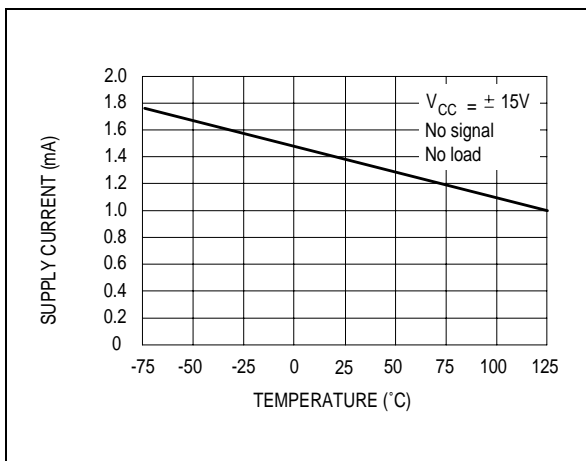

**COMMON MODE REJECTION RATIO versus FREE AIR TEMPERATURE**

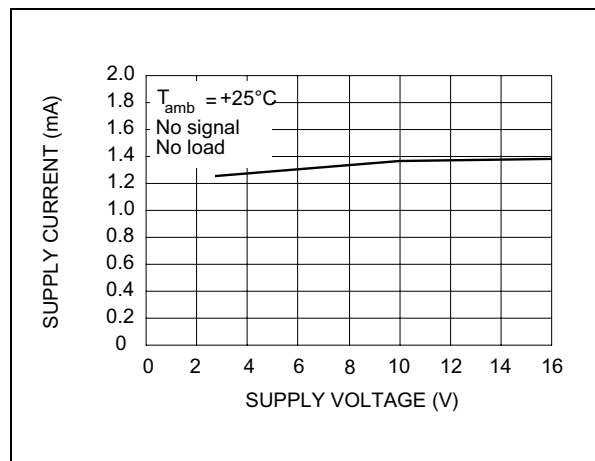

**COMMON MODE REJECTION RATIO versus FREE AIR TEMPERATURE**

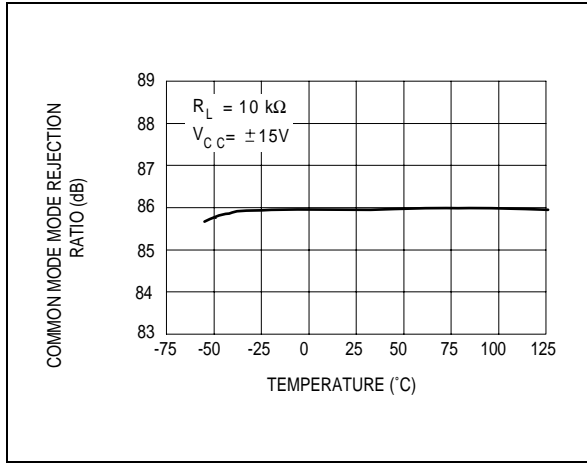

**VOLTAGE FOLLOWER LARGE SIGNAL PULSE RESPONSE**

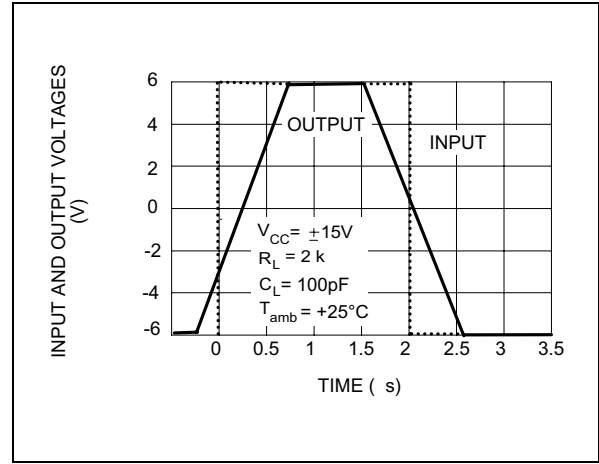

**OUTPUT VOLTAGE versus ELAPSED TIME**



**EQUIVALENT INPUT NOISE VOLTAGE versus FREQUENCY**



**TOTAL HARMONIC DISTORTION versus FREQUENCY**

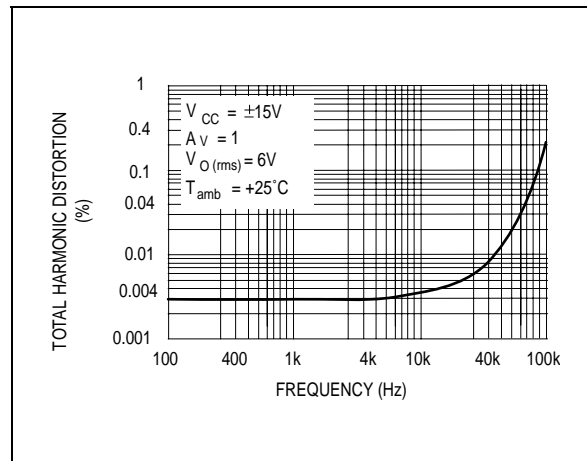

PARAMETER MEASUREMENT INFORMATION

Figure 1 : Voltage Follower

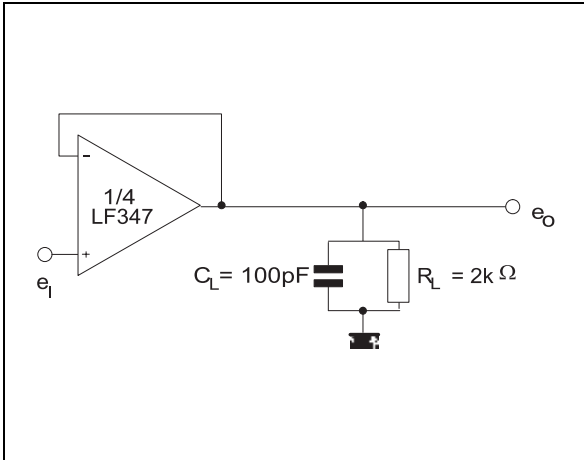
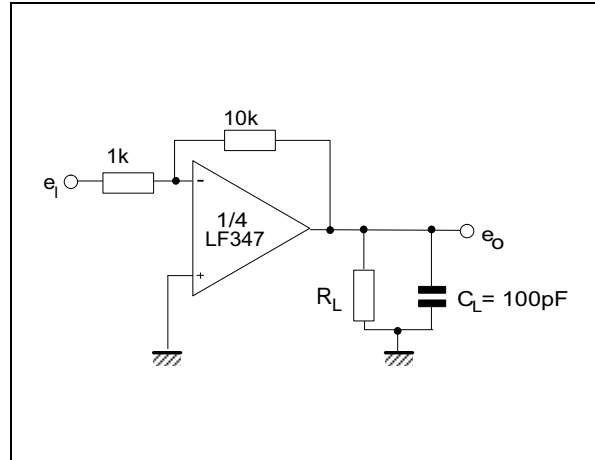
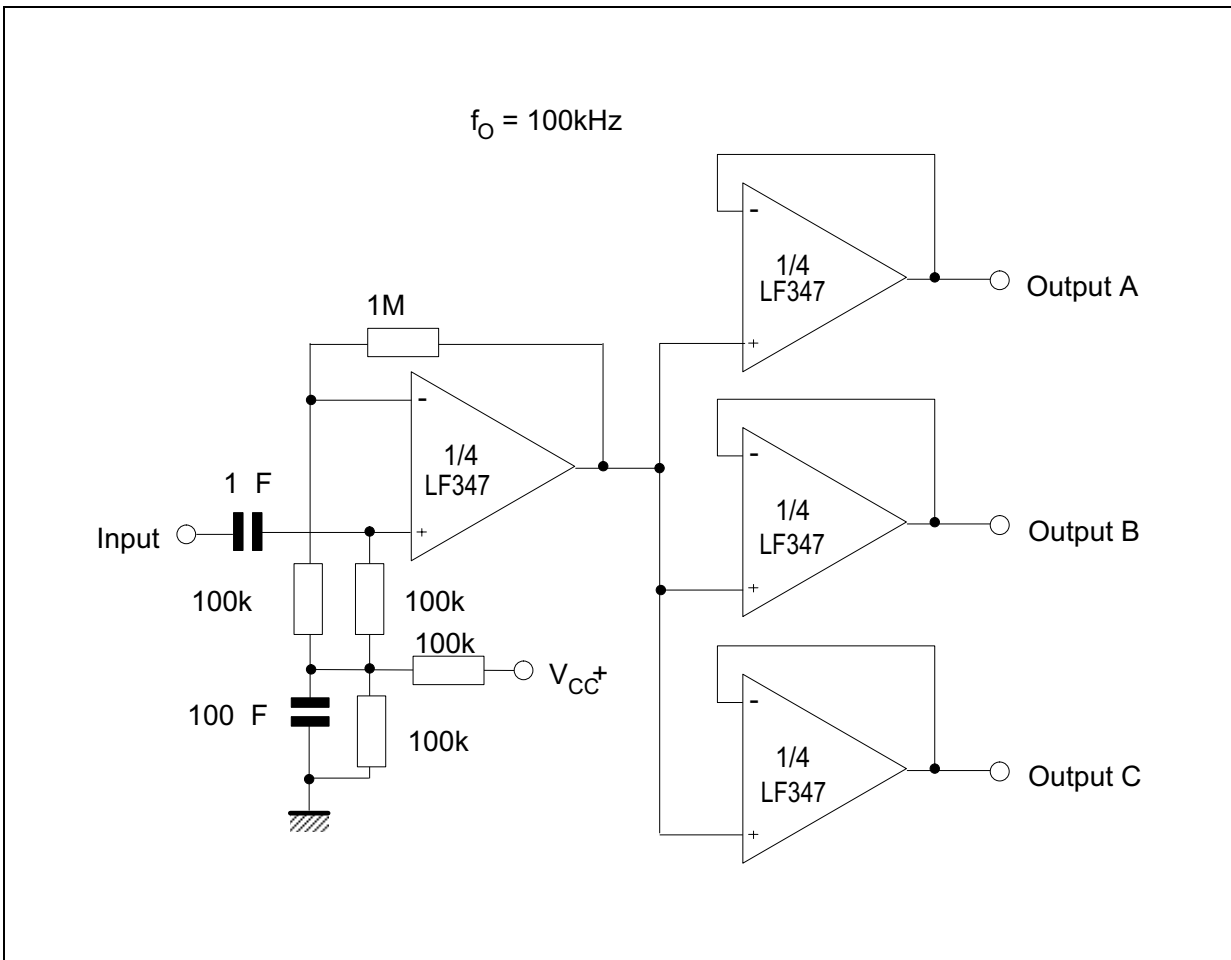

Figure 2 : Gain-of-10 Inverting Amplifier



TYPICAL APPLICATIONS

AUDIO DISTRIBUTOR AMPLIFIER



TYPICAL APPLICATIONS (continued)

POSITIVE FEEDBACK BANDPASS FILTER



OUTPUT A



OUTPUT B





**PACKAGE MECHANICAL DATA**  
14 PINS - PLASTIC DIP



Dim.	Millimeters			Inches		
	Min.	Typ.	Max.	Min.	Typ.	Max.
$a_1$	0.51			0.020		
$B$	1.39		1.65	0.055		0.065
$b$		0.5			0.020	
$b_1$		0.25			0.010	
$D$			20			0.787
$E$		8.5			0.335	
$e$		2.54			0.100	
$e_3$		15.24			0.600	
$F$			7.1			0.280
$i$			5.1			0.201
$L$		3.3			0.130	
$Z$	1.27		2.54	0.050		0.100

**PACKAGE MECHANICAL DATA**  
14 PINS - PLASTIC MICROPACKAGE (SO)

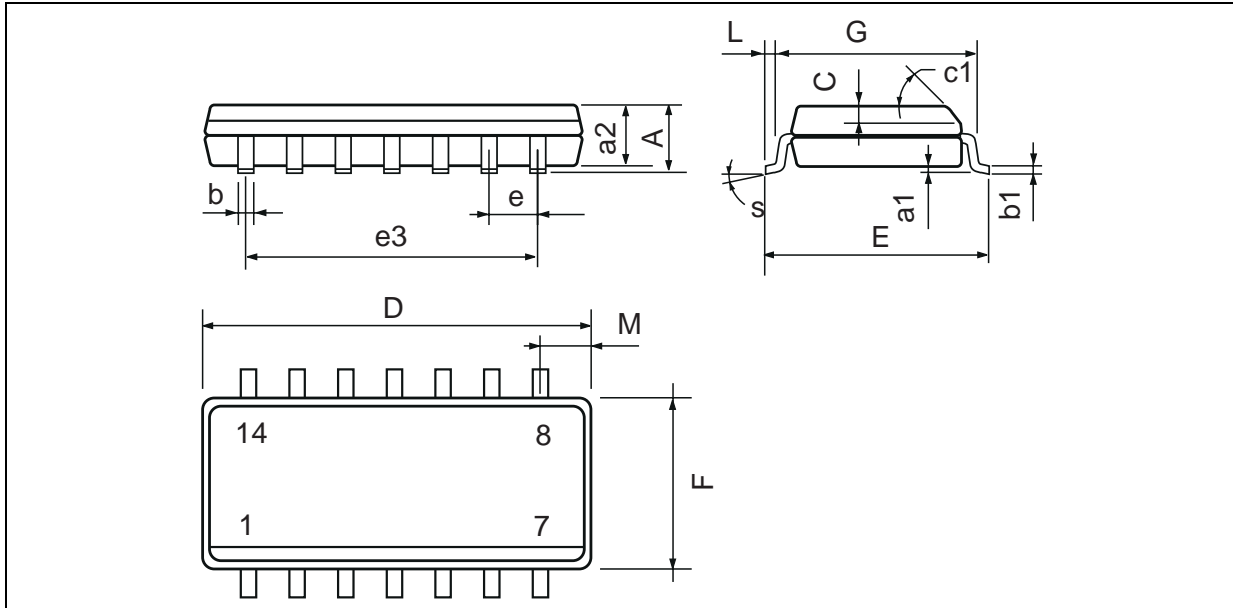

Dim.	Millimeters			Inches		
	Min.	Typ.	Max.	Min.	Typ.	Max.
A			1.75			0.069
a1	0.1		0.2	0.004		0.008
a2			1.6			0.063
b	0.35		0.46	0.014		0.018
b1	0.19		0.25	0.007		0.010
C		0.5			0.020	
c1	45° (typ.)					
D (1)	8.55		8.75	0.336		0.344
E	5.8		6.2	0.228		0.244
e		1.27			0.050	
e3		7.62			0.300	
F (1)	3.8		4.0	0.150		0.157
G	4.6		5.3	0.181		0.208
L	0.5		1.27	0.020		0.050
M			0.68			0.027
S	8° (max.)					

Note : (1) D and F do not include mold flash or protrusions - Mold flash or protrusions shall not exceed 0.15mm (.066 inc) ONLY FOR DATA BOOK.

Information furnished is believed to be accurate and reliable. However, STMicroelectronics assumes no responsibility for the consequences of use of such information nor for any infringement of patents or other rights of third parties which may result from its use. No license is granted by implication or otherwise under any patent or patent rights of STMicroelectronics. Specifications mentioned in this publication are subject to change without notice. This publication supersedes and replaces all information previously supplied. STMicroelectronics products are not authorized for use as critical components in life support devices or systems without express written approval of STMicroelectronics.

© The ST logo is a registered trademark of STMicroelectronics

© 2001 STMicroelectronics - Printed in Italy - All Rights Reserved  
**STMicroelectronics GROUP OF COMPANIES**

Australia - Brazil - China - Finland - France - Germany - Hong Kong - India - Italy - Japan - Malaysia - Malta - Morocco  
Singapore - Spain - Sweden - Switzerland - United Kingdom

© <http://www.st.com>

Компания «Океан Электроники» предлагает заключение долгосрочных отношений при поставках импортных электронных компонентов на взаимовыгодных условиях!

Наши преимущества:

- Поставка оригинальных импортных электронных компонентов напрямую с производств Америки, Европы и Азии, а так же с крупнейших складов мира;
- Широкая линейка поставок активных и пассивных импортных электронных компонентов (более 30 млн. наименований);
- Поставка сложных, дефицитных, либо снятых с производства позиций;
- Оперативные сроки поставки под заказ (от 5 рабочих дней);
- Экспресс доставка в любую точку России;
- Помощь Конструкторского Отдела и консультации квалифицированных инженеров;
- Техническая поддержка проекта, помощь в подборе аналогов, поставка прототипов;
- Поставка электронных компонентов под контролем ВП;
- Система менеджмента качества сертифицирована по Международному стандарту ISO 9001;
- При необходимости вся продукция военного и аэрокосмического назначения проходит испытания и сертификацию в лаборатории (по согласованию с заказчиком);
- Поставка специализированных компонентов военного и аэрокосмического уровня качества (Xilinx, Altera, Analog Devices, Intersil, Interpoint, Microsemi, Actel, Aeroflex, Peregrine, VPT, Syfer, Eurofarad, Texas Instruments, MS Kennedy, Miteq, Cobham, E2V, MA-COM, Hittite, Mini-Circuits, General Dynamics и др.);

Компания «Океан Электроники» является официальным дистрибьютором и эксклюзивным представителем в России одного из крупнейших производителей разъемов военного и аэрокосмического назначения «JONHON», а так же официальным дистрибьютором и эксклюзивным представителем в России производителя высокотехнологичных и надежных решений для передачи СВЧ сигналов «FORSTAR».



## JONHON

«JONHON» (основан в 1970 г.)

Разъемы специального, военного и аэрокосмического назначения:

(Применяются в военной, авиационной, аэрокосмической, морской, железнодорожной, горно- и нефтедобывающей отраслях промышленности)

«FORSTAR» (основан в 1998 г.)

ВЧ соединители, коаксиальные кабели, кабельные сборки и микроволновые компоненты:

(Применяются в телекоммуникациях гражданского и специального назначения, в средствах связи, РЛС, а так же военной, авиационной и аэрокосмической отраслях промышленности).



Телефон: 8 (812) 309-75-97 (многоканальный)

Факс: 8 (812) 320-03-32

Электронная почта: [ocean@oceanchips.ru](mailto:ocean@oceanchips.ru)

Web: <http://oceanchips.ru/>

Адрес: 198099, г. Санкт-Петербург, ул. Калинина, д. 2, корп. 4, лит. А