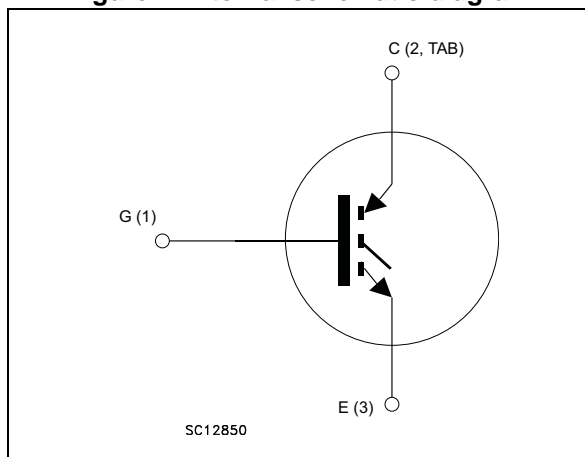

Figure 1. Internal schematic diagram



Features

- Maximum junction temperature: $T_J = 175\text{ }^\circ\text{C}$
- Tail-less switching off
- $V_{CE(sat)} = 1.85\text{ V (typ.) @ } I_C = 30\text{ A}$
- Tight parameters distribution
- Safe paralleling
- Low thermal resistance

Applications

- Photovoltaic inverters
- Uninterruptible power supply
- Welding
- Power factor correction
- Very high frequency converters

Description

This device is an IGBT developed using an advanced proprietary trench gate field-stop structure. The device is part of the V series of IGBTs, which represent an optimum compromise between conduction and switching losses to maximize the efficiency of very high frequency converters. Furthermore, a positive $V_{CE(sat)}$ temperature coefficient and very tight parameter distribution result in safer paralleling operation.

Table 1. Device summary

Order codes	Marking	Package	Packaging
STGFW30V60F	GFW30V60F	TO-3PF	Tube
STGW30V60F	GW30V60F	TO-247	Tube
STGWT30V60F	GWT30V60F	TO-3P	Tube

Contents

- 1 Electrical ratings 3**
- 2 Electrical characteristics 4**
 - 2.1 Electrical characteristics (curves) 6
- 3 Test circuits 11**
- 4 Package mechanical data 12**
 - 4.1 TO-3PF, STGFW30V60F 12
 - 4.2 TO-247, STGW30V60F 14
 - 4.3 TO-3P, STGWT30V60F 16
- 5 Revision history 18**

1 Electrical ratings

Table 2. Absolute maximum ratings

Symbol	Parameter	Value		Unit
		TO-3P TO-247	TO-3PF	
V_{CES}	Collector-emitter voltage ($V_{GE} = 0$)	600		V
I_C	Continuous collector current at $T_C = 25\text{ °C}$	60	60 ⁽¹⁾	A
I_C	Continuous collector current at $T_C = 100\text{ °C}$	30	30 ⁽¹⁾	A
$I_{CP}^{(2)}$	Pulsed collector current	120	120 ⁽¹⁾	A
V_{GE}	Gate-emitter voltage	±20		V
P_{TOT}	Total dissipation at $T_C = 25\text{ °C}$	260	58	W
V_{ISO}	Insulation withstand voltage (RMS) from all three leads to external heat sink ($t = 1\text{ s}$; $T_C = 25\text{ °C}$)		3.5	kV
T_{STG}	Storage temperature range	- 55 to 150		°C
T_J	Operating junction temperature	- 55 to 175		°C

1. Limited by maximum junction temperature.
2. Pulse width limited by maximum junction temperature.

Table 3. Thermal data

Symbol	Parameter	Value		Unit
		TO-3P TO-247	TO-3PF	
R_{thJC}	Thermal resistance junction-case	0.58	2.6	°C/W
R_{thJA}	Thermal resistance junction-ambient	50		°C/W

2 Electrical characteristics

$T_J = 25\text{ °C}$ unless otherwise specified.

Table 4. Static characteristics

Symbol	Parameter	Test conditions	Min.	Typ.	Max.	Unit
$V_{(BR)CES}$	Collector-emitter breakdown voltage ($V_{GE} = 0$)	$I_C = 2\text{ mA}$	600			V
$V_{CE(sat)}$	Collector-emitter saturation voltage	$V_{GE} = 15\text{ V}, I_C = 30\text{ A}$		1.85	2.3	V
		$V_{GE} = 15\text{ V}, I_C = 30\text{ A}$ $T_J = 125\text{ °C}$		2.15		
		$V_{GE} = 15\text{ V}, I_C = 30\text{ A}$ $T_J = 175\text{ °C}$		2.35		
$V_{GE(th)}$	Gate threshold voltage	$V_{CE} = V_{GE}, I_C = 1\text{ mA}$	5	6	7	V
I_{CES}	Collector cut-off current ($V_{GE} = 0$)	$V_{CE} = 600\text{ V}$			25	μA
I_{GES}	Gate-emitter leakage current ($V_{CE} = 0$)	$V_{GE} = \pm 20\text{ V}$			250	nA

Table 5. Dynamic characteristics

Symbol	Parameter	Test conditions	Min.	Typ.	Max.	Unit
C_{ies}	Input capacitance	$V_{CE} = 25\text{ V}, f = 1\text{ MHz},$ $V_{GE} = 0$	-	3750	-	pF
C_{oes}	Output capacitance		-	120	-	pF
C_{res}	Reverse transfer capacitance		-	77	-	pF
Q_g	Total gate charge	$V_{CC} = 480\text{ V}, I_C = 30\text{ A},$ $V_{GE} = 15\text{ V},$ see Figure 26	-	163	-	nC
Q_{ge}	Gate-emitter charge		-	28	-	nC
Q_{gc}	Gate-collector charge		-	72	-	nC

Table 6. IGBT switching characteristics (inductive load)

Symbol	Parameter	Test conditions	Min.	Typ.	Max.	Unit
$t_{d(on)}$	Turn-on delay time	$V_{CE} = 400\text{ V}$, $I_C = 30\text{ A}$, $R_G = 10\ \Omega$, $V_{GE} = 15\text{ V}$, see Figure 25	-	45	-	ns
t_r	Current rise time		-	16	-	ns
$(di/dt)_{on}$	Turn-on current slope		-	1500	-	A/ μ s
$t_{d(off)}$	Turn-off delay time		-	189	-	ns
t_f	Current fall time		-	19	-	ns
$E_{on}^{(1)}$	Turn-on switching losses		-	383	-	μ J
$E_{off}^{(2)}$	Turn-off switching losses		-	233	-	μ J
E_{ts}	Total switching losses	-	616	-	μ J	
$t_{d(on)}$	Turn-on delay time	$V_{CE} = 400\text{ V}$, $I_C = 30\text{ A}$, $R_G = 10\ \Omega$, $V_{GE} = 15\text{ V}$, $T_J = 175\text{ }^\circ\text{C}$, see Figure 25	-	42	-	ns
t_r	Current rise time		-	17	-	ns
$(di/dt)_{on}$	Turn-on current slope		-	1337	-	A/ μ s
$t_{d(off)}$	Turn-off delay time		-	193	-	ns
t_f	Current fall time		-	32	-	ns
$E_{on}^{(1)}$	Turn-on switching losses		-	794	-	μ J
$E_{off}^{(2)}$	Turn-off switching losses		-	378	-	μ J
E_{ts}	Total switching losses	-	1172	-	μ J	

1. Energy losses include reverse recovery of the external diode. The diode is the same of the copacked STGW30V60DF.
2. Turn-off losses include also the tail of the collector current.

2.1 Electrical characteristics (curves)

Figure 2. Power dissipation vs. case temperature for TO-247 and TO-3P

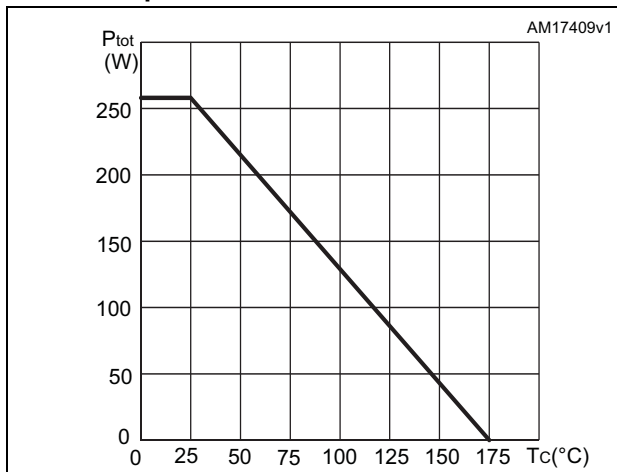

Figure 3. Collector current vs. case temperature for TO-247 and TO-3P

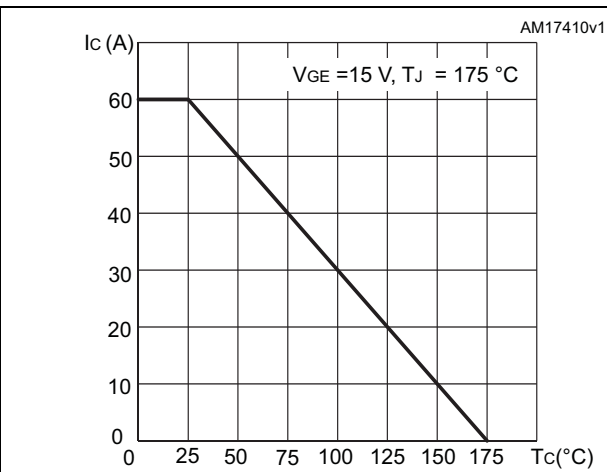

Figure 4. Power dissipation vs. case temperature for TO-3PF

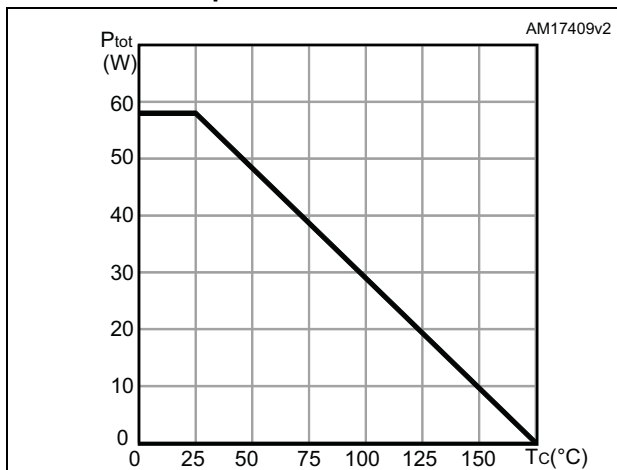

Figure 5. Collector current vs. case temperature for TO-3PF

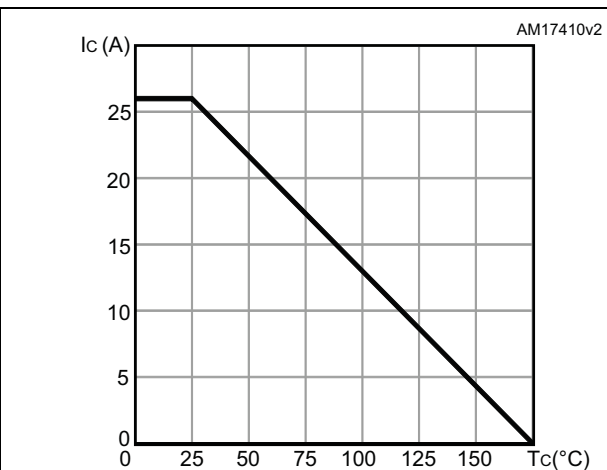

Figure 6. Output characteristics (T_J=25°C)

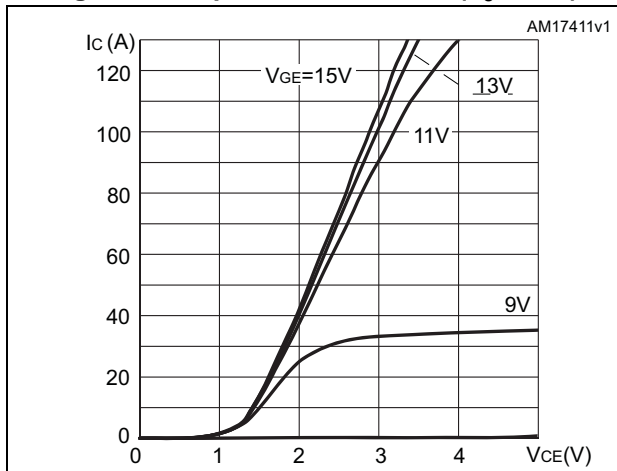

Figure 7. Output characteristics (T_J=175°C)

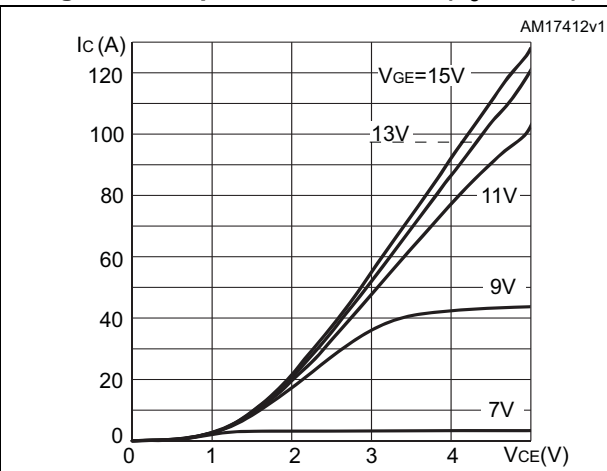

Figure 8. $V_{CE(sat)}$ vs. junction temperature

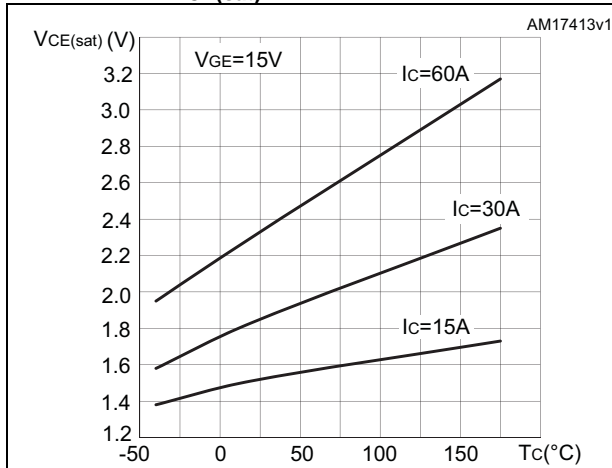

Figure 9. $V_{CE(sat)}$ vs. collector current

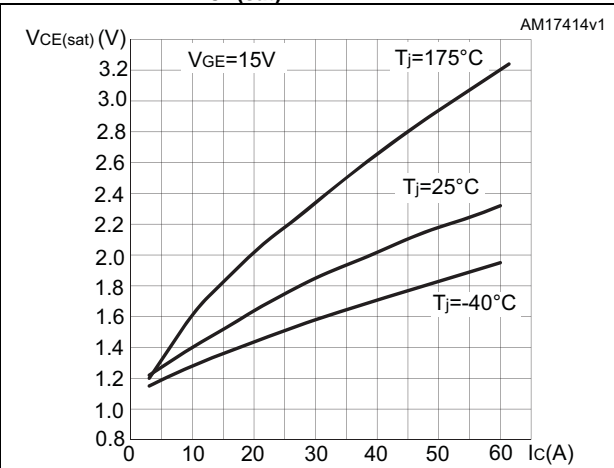

Figure 10. Safe operating area for TO-3PF

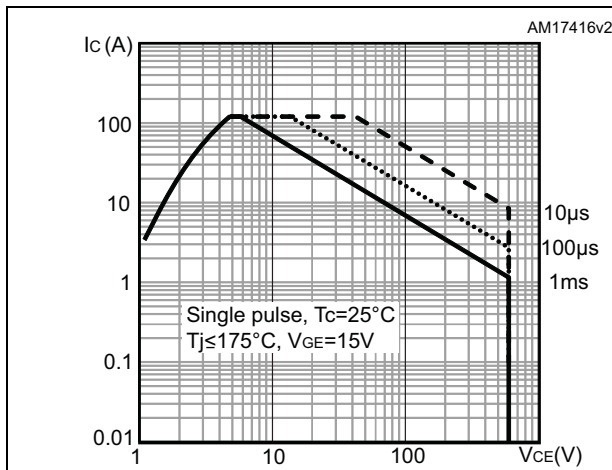

Figure 11. Safe operating area for TO-247 and TO-3P

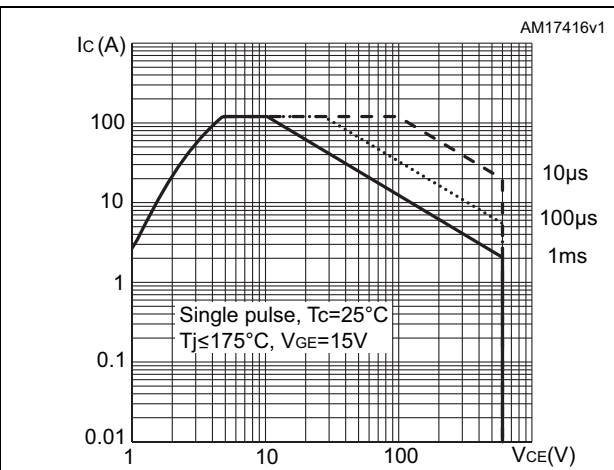

Figure 12. Normalized $V_{GE(th)}$ vs junction temperature

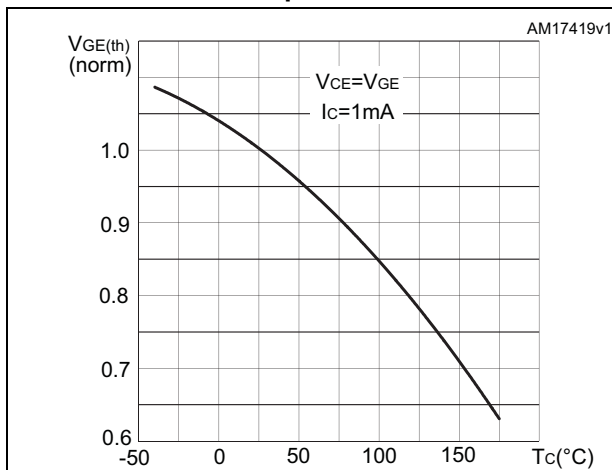

Figure 13. Normalized $V_{(BR)CES}$ vs. junction temperature

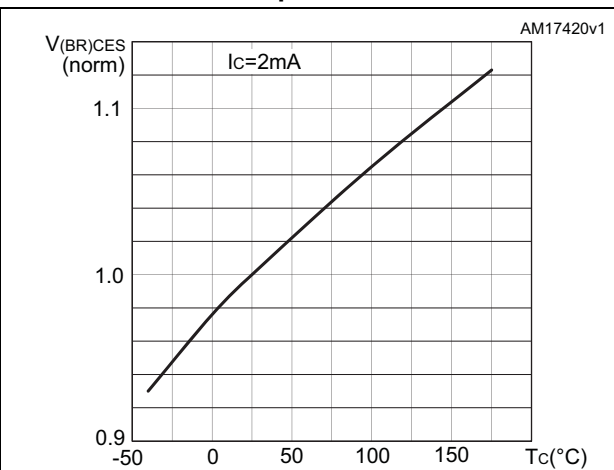

Figure 14. Capacitance variations

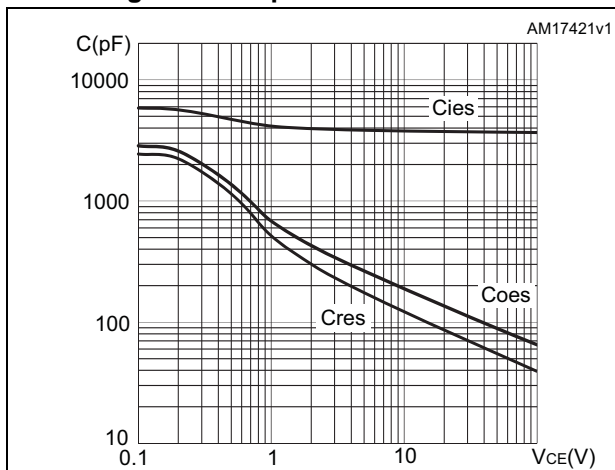

Figure 15. Gate charge vs. gate-emitter voltage

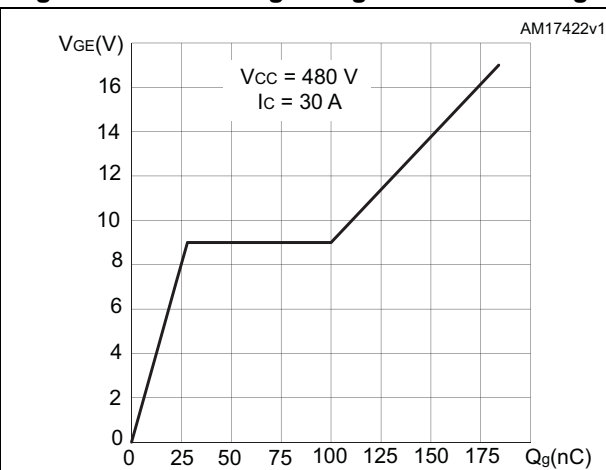

Figure 16. Switching losses vs. collector current

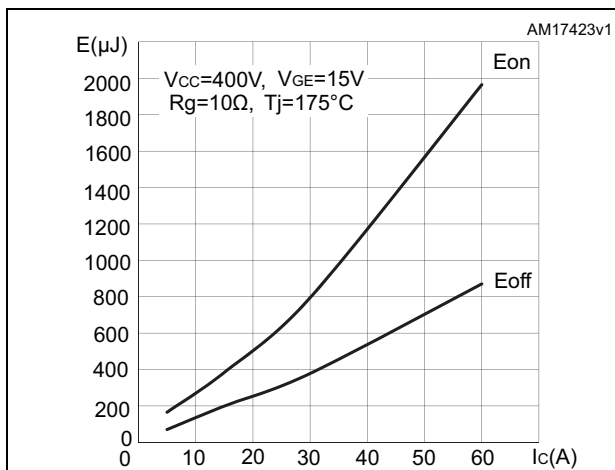

Figure 17. Switching losses vs. gate resistance

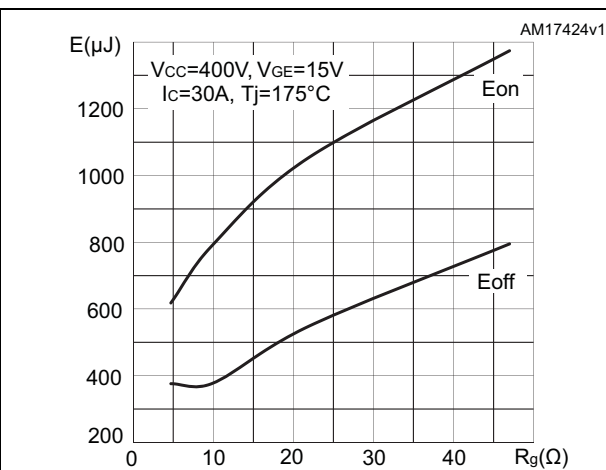

Figure 18. Switching losses vs. junction temperature

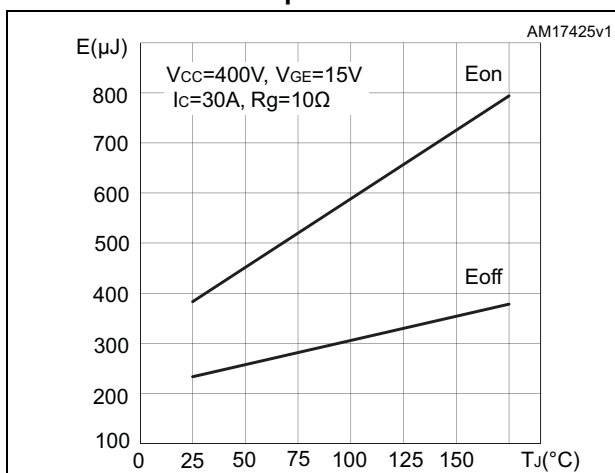

Figure 19. Switching losses vs. collector emitter voltage

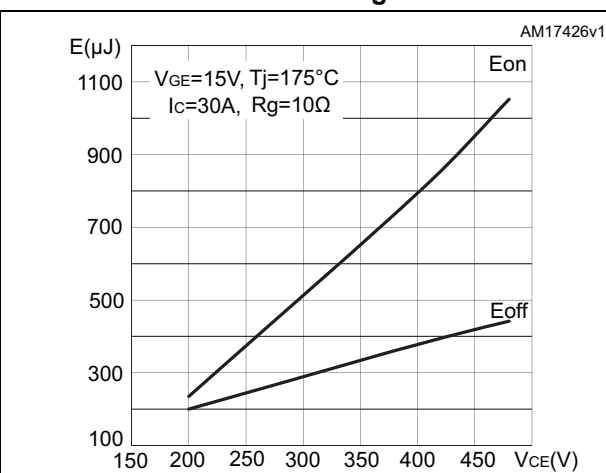

Figure 20. Switching times vs. collector current

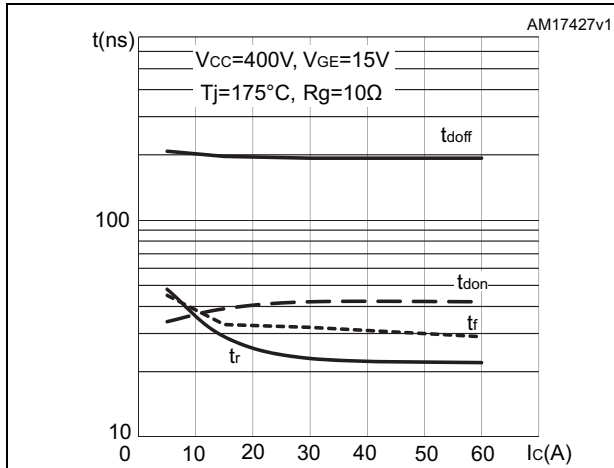

Figure 21. Switching times vs. gate resistance

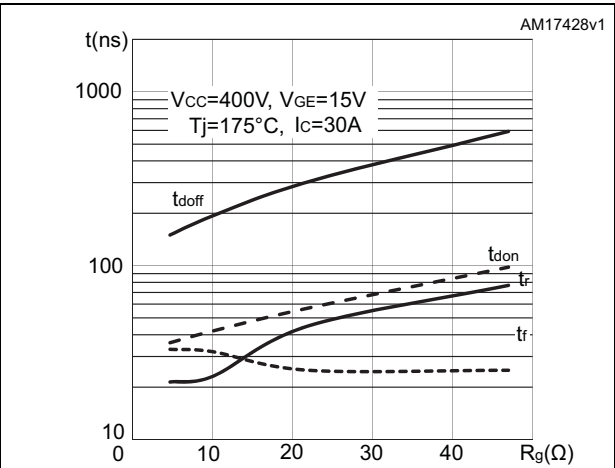

Figure 22. Transfer characteristics

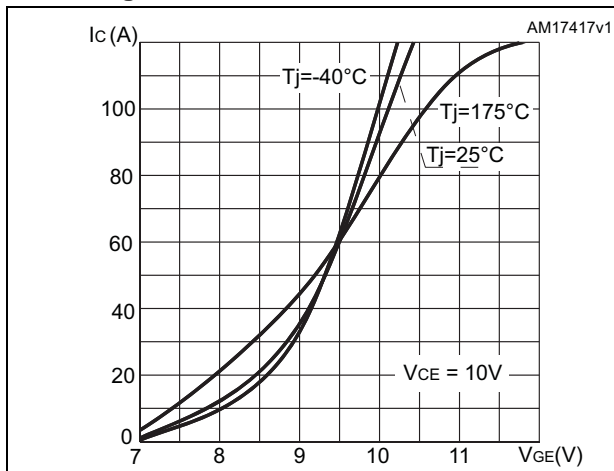

Figure 23. Thermal data for TO-3PF

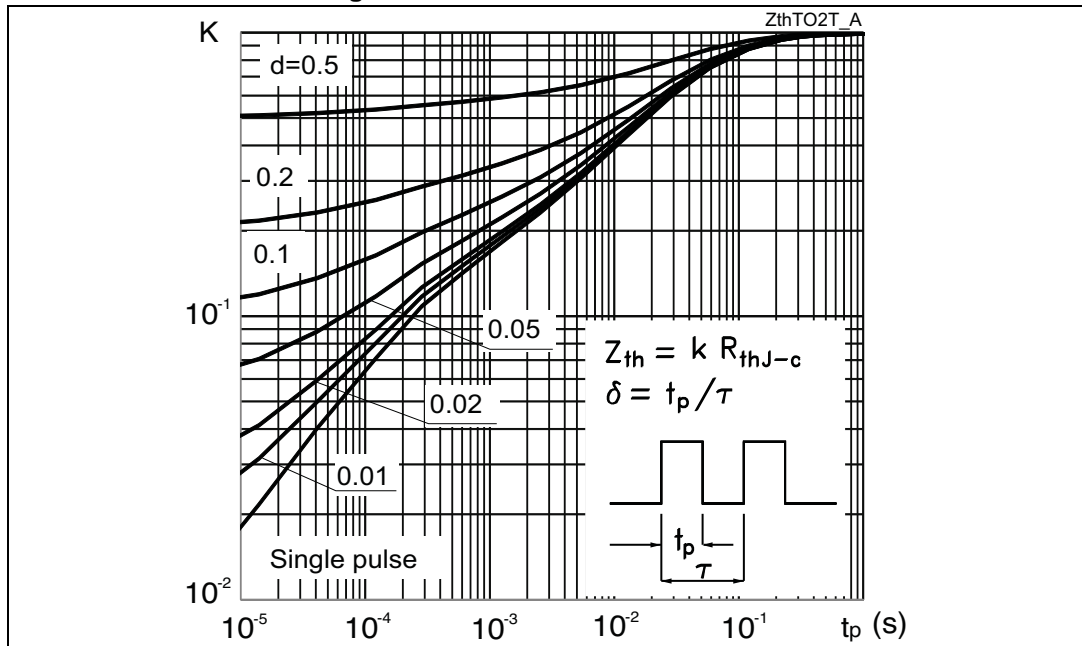
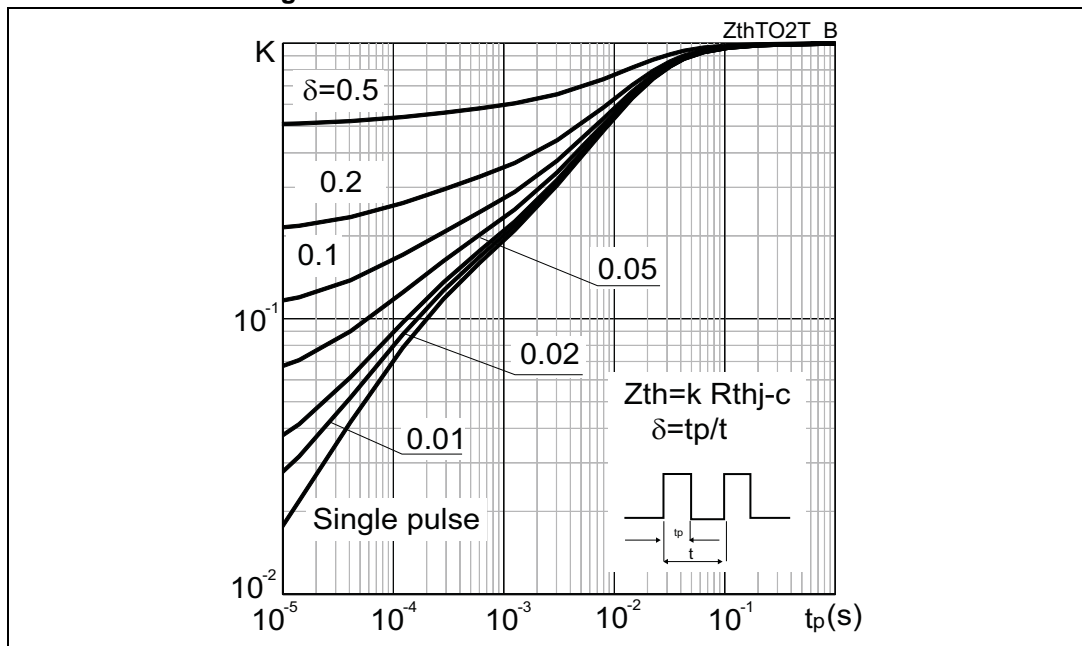

Figure 24. Thermal data for TO-3P and TO-247



3 Test circuits

Figure 25. Test circuit for inductive load switching



Figure 26. Gate charge test circuit

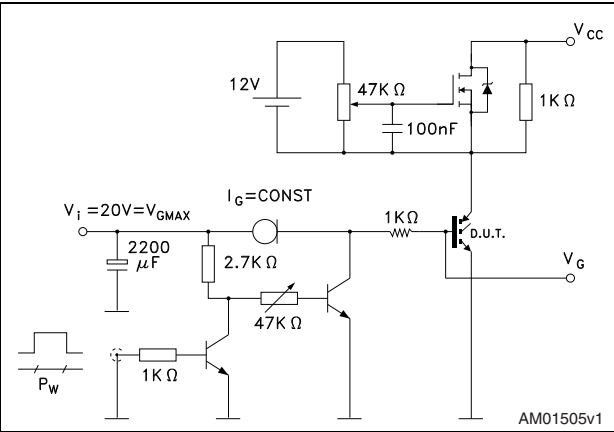

Figure 27. Switching waveform



4 Package mechanical data

In order to meet environmental requirements, ST offers these devices in different grades of ECOPACK® packages, depending on their level of environmental compliance. ECOPACK® specifications, grade definitions and product status are available at: www.st.com. ECOPACK is an ST trademark.

4.1 TO-3PF, STGFW30V60F

Figure 28. TO-3PF drawing

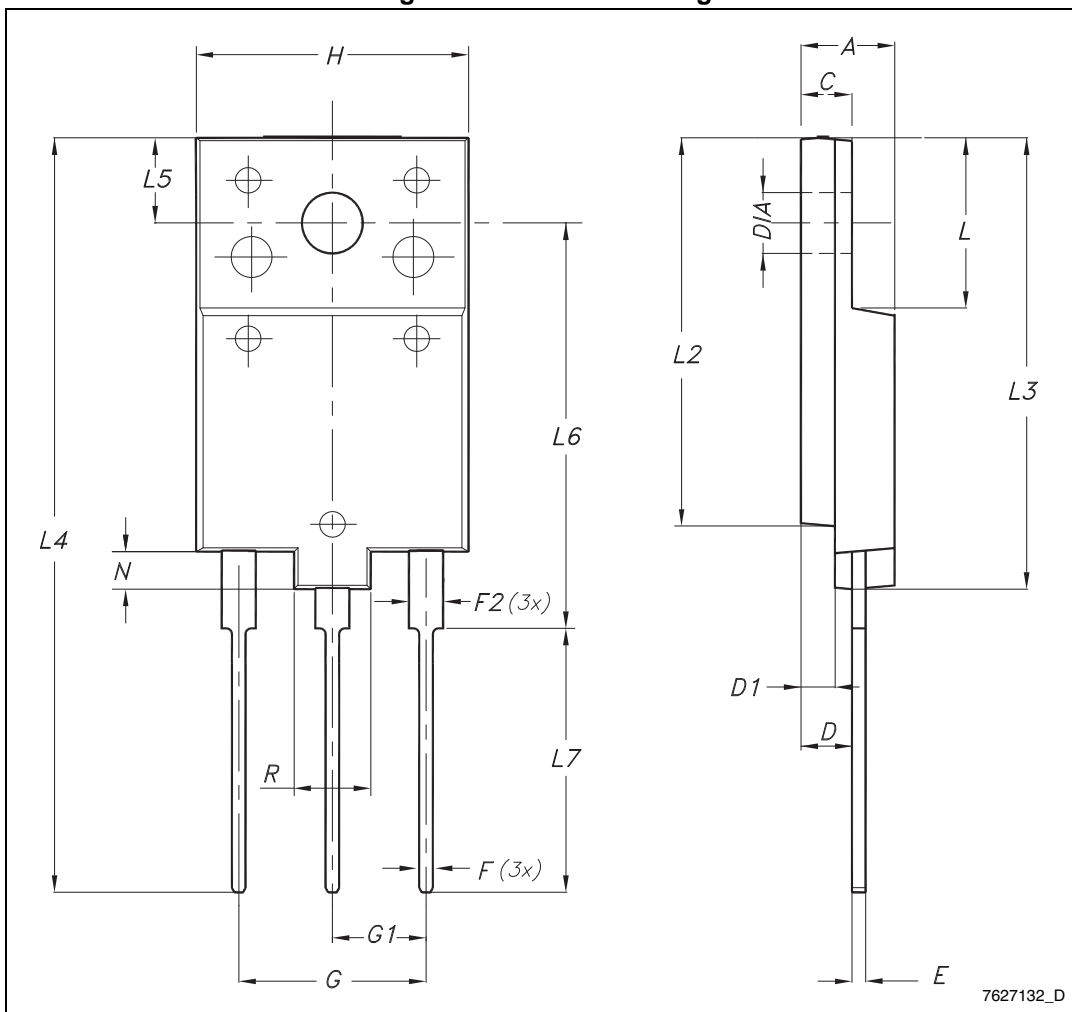

Table 7. TO-3PF mechanical data

Dim.	mm		
	Min.	Typ.	Max.
A	5.30		5.70
C	2.80		3.20
D	3.10		3.50
D1	1.80		2.20
E	0.80		1.10
F	0.65		0.95
F2	1.80		2.20
G	10.30		11.50
G1		5.45	
H	15.30		15.70
L	9.80	10	10.20
L2	22.80		23.20
L3	26.30		26.70
L4	43.20		44.40
L5	4.30		4.70
L6	24.30		24.70
L7	14.60		15
N	1.80		2.20
R	3.80		4.20
Dia	3.40		3.80

4.2 TO-247, STGW30V60F

Figure 29. TO-247 drawing

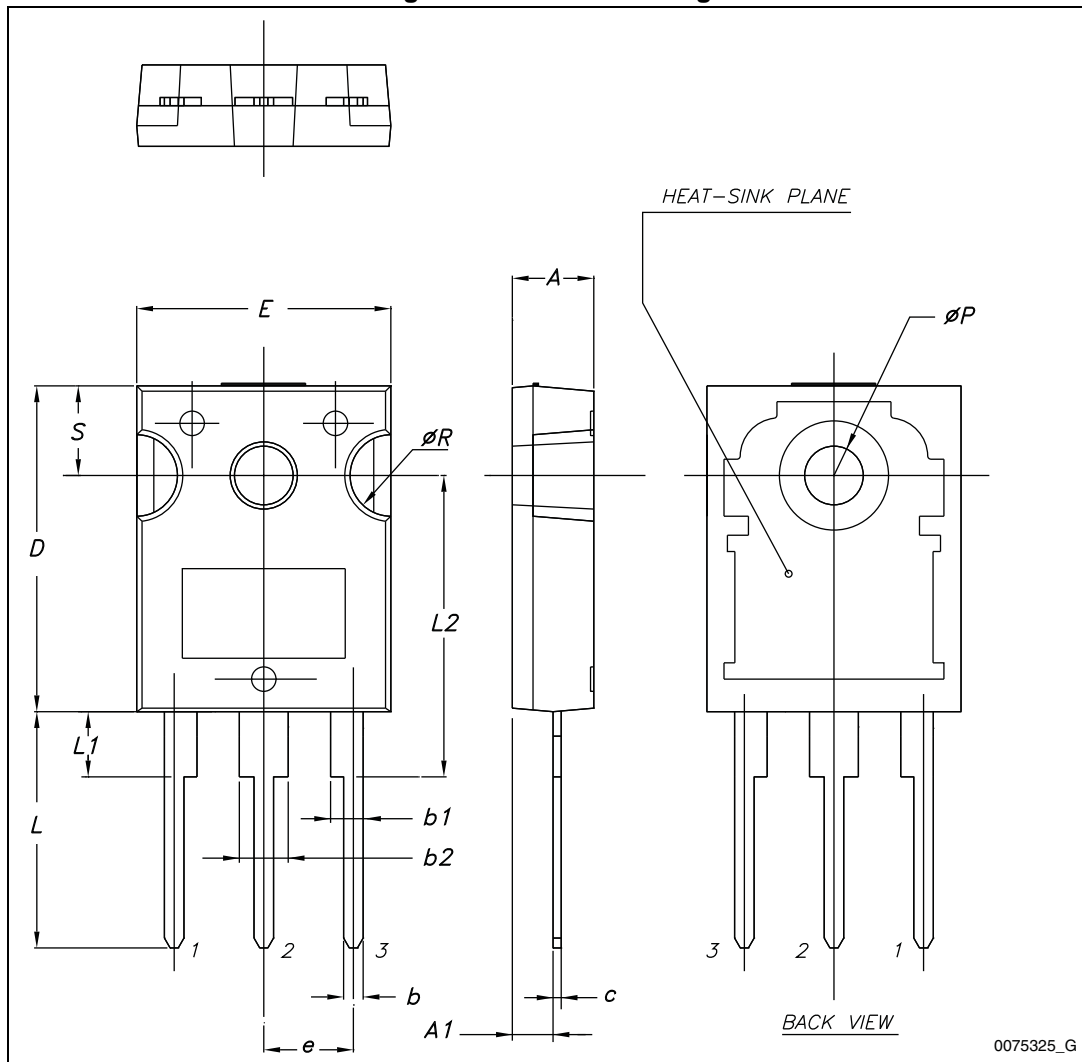

Table 8. TO-247 mechanical data

Dim.	mm.		
	Min.	Typ.	Max.
A	4.85		5.15
A1	2.20		2.60
b	1.0		1.40
b1	2.0		2.40
b2	3.0		3.40
c	0.40		0.80
D	19.85		20.15
E	15.45		15.75
e	5.30	5.45	5.60
L	14.20		14.80
L1	3.70		4.30
L2		18.50	
ØP	3.55		3.65
ØR	4.50		5.50
S	5.30	5.50	5.70

4.3 TO-3P, STGWT30V60F

Figure 30. TO-3P drawing

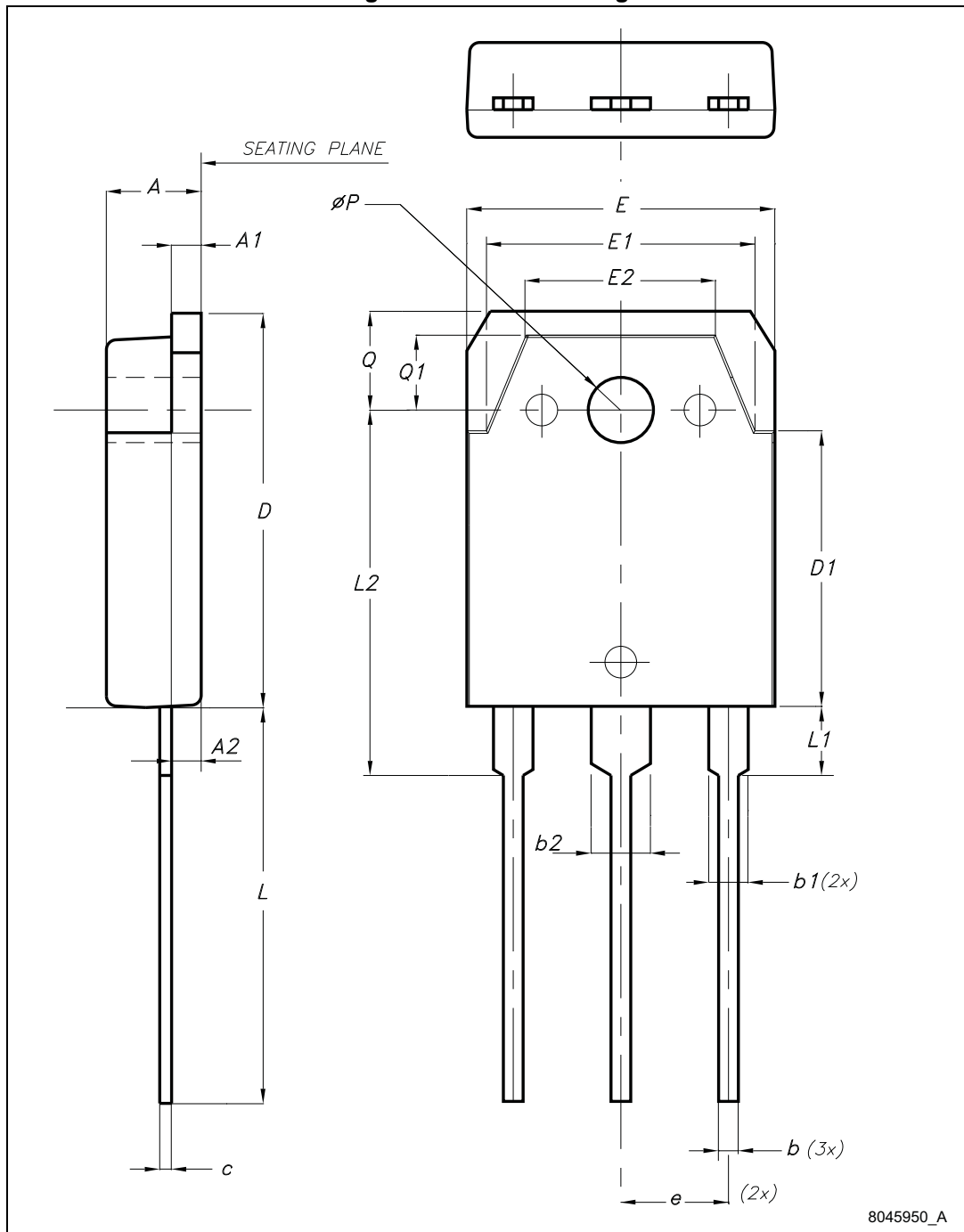

Table 9. TO-3P mechanical data

Dim.	mm		
	Min.	Typ.	Max.
A	4.60		5
A1	1.45	1.50	1.65
A2	1.20	1.40	1.60
b	0.80	1	1.20
b1	1.80		2.20
b2	2.80		3.20
c	0.55	0.60	0.75
D	19.70	19.90	20.10
D1		13.90	
E	15.40		15.80
E1		13.60	
E2		9.60	
e	5.15	5.45	5.75
L	19.50	20	20.50
L1		3.50	
L2	18.20	18.40	18.60
øP	3.10		3.30
Q		5	
Q1		3.80	

5 Revision history

Table 10. Document revision history

Date	Revision	Changes
24-Jul-2013	1	Initial release.
29-Jul-2013	2	Updated Table 1: Device summary .
08-Oct-2013	3	Updated title, features and description in cover page.
08-Apr-2014	4	Updated Table 4: Static characteristics and Section 4: Package mechanical data .

Please Read Carefully:

Information in this document is provided solely in connection with ST products. STMicroelectronics NV and its subsidiaries ("ST") reserve the right to make changes, corrections, modifications or improvements, to this document, and the products and services described herein at any time, without notice.

All ST products are sold pursuant to ST's terms and conditions of sale.

Purchasers are solely responsible for the choice, selection and use of the ST products and services described herein, and ST assumes no liability whatsoever relating to the choice, selection or use of the ST products and services described herein.

No license, express or implied, by estoppel or otherwise, to any intellectual property rights is granted under this document. If any part of this document refers to any third party products or services it shall not be deemed a license grant by ST for the use of such third party products or services, or any intellectual property contained therein or considered as a warranty covering the use in any manner whatsoever of such third party products or services or any intellectual property contained therein.

UNLESS OTHERWISE SET FORTH IN ST'S TERMS AND CONDITIONS OF SALE ST DISCLAIMS ANY EXPRESS OR IMPLIED WARRANTY WITH RESPECT TO THE USE AND/OR SALE OF ST PRODUCTS INCLUDING WITHOUT LIMITATION IMPLIED WARRANTIES OF MERCHANTABILITY, FITNESS FOR A PARTICULAR PURPOSE (AND THEIR EQUIVALENTS UNDER THE LAWS OF ANY JURISDICTION), OR INFRINGEMENT OF ANY PATENT, COPYRIGHT OR OTHER INTELLECTUAL PROPERTY RIGHT.

ST PRODUCTS ARE NOT DESIGNED OR AUTHORIZED FOR USE IN: (A) SAFETY CRITICAL APPLICATIONS SUCH AS LIFE SUPPORTING, ACTIVE IMPLANTED DEVICES OR SYSTEMS WITH PRODUCT FUNCTIONAL SAFETY REQUIREMENTS; (B) AERONAUTIC APPLICATIONS; (C) AUTOMOTIVE APPLICATIONS OR ENVIRONMENTS, AND/OR (D) AEROSPACE APPLICATIONS OR ENVIRONMENTS. WHERE ST PRODUCTS ARE NOT DESIGNED FOR SUCH USE, THE PURCHASER SHALL USE PRODUCTS AT PURCHASER'S SOLE RISK, EVEN IF ST HAS BEEN INFORMED IN WRITING OF SUCH USAGE, UNLESS A PRODUCT IS EXPRESSLY DESIGNATED BY ST AS BEING INTENDED FOR "AUTOMOTIVE, AUTOMOTIVE SAFETY OR MEDICAL" INDUSTRY DOMAINS ACCORDING TO ST PRODUCT DESIGN SPECIFICATIONS. PRODUCTS FORMALLY ESCC, QML OR JAN QUALIFIED ARE DEEMED SUITABLE FOR USE IN AEROSPACE BY THE CORRESPONDING GOVERNMENTAL AGENCY.

Resale of ST products with provisions different from the statements and/or technical features set forth in this document shall immediately void any warranty granted by ST for the ST product or service described herein and shall not create or extend in any manner whatsoever, any liability of ST.

ST and the ST logo are trademarks or registered trademarks of ST in various countries.

Information in this document supersedes and replaces all information previously supplied.

The ST logo is a registered trademark of STMicroelectronics. All other names are the property of their respective owners.

© 2014 STMicroelectronics - All rights reserved

STMicroelectronics group of companies

Australia - Belgium - Brazil - Canada - China - Czech Republic - Finland - France - Germany - Hong Kong - India - Israel - Italy - Japan - Malaysia - Malta - Morocco - Philippines - Singapore - Spain - Sweden - Switzerland - United Kingdom - United States of America

www.st.com



Компания «Океан Электроники» предлагает заключение долгосрочных отношений при поставках импортных электронных компонентов на взаимовыгодных условиях!

Наши преимущества:

- Поставка оригинальных импортных электронных компонентов напрямую с производств Америки, Европы и Азии, а так же с крупнейших складов мира;
- Широкая линейка поставок активных и пассивных импортных электронных компонентов (более 30 млн. наименований);
- Поставка сложных, дефицитных, либо снятых с производства позиций;
- Оперативные сроки поставки под заказ (от 5 рабочих дней);
- Экспресс доставка в любую точку России;
- Помощь Конструкторского Отдела и консультации квалифицированных инженеров;
- Техническая поддержка проекта, помощь в подборе аналогов, поставка прототипов;
- Поставка электронных компонентов под контролем ВП;
- Система менеджмента качества сертифицирована по Международному стандарту ISO 9001;
- При необходимости вся продукция военного и аэрокосмического назначения проходит испытания и сертификацию в лаборатории (по согласованию с заказчиком);
- Поставка специализированных компонентов военного и аэрокосмического уровня качества (Xilinx, Altera, Analog Devices, Intersil, Interpoint, Microsemi, Actel, Aeroflex, Peregrine, VPT, Syfer, Eurofarad, Texas Instruments, MS Kennedy, Miteq, Cobham, E2V, MA-COM, Hittite, Mini-Circuits, General Dynamics и др.);

Компания «Океан Электроники» является официальным дистрибьютором и эксклюзивным представителем в России одного из крупнейших производителей разъемов военного и аэрокосмического назначения «JONHON», а так же официальным дистрибьютором и эксклюзивным представителем в России производителя высокотехнологичных и надежных решений для передачи СВЧ сигналов «FORSTAR».



JONHON

«JONHON» (основан в 1970 г.)

Разъемы специального, военного и аэрокосмического назначения:

(Применяются в военной, авиационной, аэрокосмической, морской, железнодорожной, горно- и нефтедобывающей отраслях промышленности)

«FORSTAR» (основан в 1998 г.)

ВЧ соединители, коаксиальные кабели, кабельные сборки и микроволновые компоненты:

(Применяются в телекоммуникациях гражданского и специального назначения, в средствах связи, РЛС, а так же военной, авиационной и аэрокосмической отраслях промышленности).



Телефон: 8 (812) 309-75-97 (многоканальный)

Факс: 8 (812) 320-03-32

Электронная почта: ocean@oceanchips.ru

Web: <http://oceanchips.ru/>

Адрес: 198099, г. Санкт-Петербург, ул. Калинина, д. 2, корп. 4, лит. А