



Is Now Part of



ON Semiconductor®

To learn more about ON Semiconductor, please visit our website at
www.onsemi.com

Please note: As part of the Fairchild Semiconductor integration, some of the Fairchild orderable part numbers will need to change in order to meet ON Semiconductor's system requirements. Since the ON Semiconductor product management systems do not have the ability to manage part nomenclature that utilizes an underscore (_), the underscore (_) in the Fairchild part numbers will be changed to a dash (-). This document may contain device numbers with an underscore (_). Please check the ON Semiconductor website to verify the updated device numbers. The most current and up-to-date ordering information can be found at www.onsemi.com. Please email any questions regarding the system integration to Fairchild_questions@onsemi.com.

ON Semiconductor and the ON Semiconductor logo are trademarks of Semiconductor Components Industries, LLC dba ON Semiconductor or its subsidiaries in the United States and/or other countries. ON Semiconductor owns the rights to a number of patents, trademarks, copyrights, trade secrets, and other intellectual property. A listing of ON Semiconductor's product/patent coverage may be accessed at www.onsemi.com/site/pdf/Patent-Marking.pdf. ON Semiconductor reserves the right to make changes without further notice to any products herein. ON Semiconductor makes no warranty, representation or guarantee regarding the suitability of its products for any particular purpose, nor does ON Semiconductor assume any liability arising out of the application or use of any product or circuit, and specifically disclaims any and all liability, including without limitation special, consequential or incidental damages. Buyer is responsible for its products and applications using ON Semiconductor products, including compliance with all laws, regulations and safety requirements or standards, regardless of any support or applications information provided by ON Semiconductor. "Typical" parameters which may be provided in ON Semiconductor data sheets and/or specifications can and do vary in different applications and actual performance may vary over time. All operating parameters, including "Typicals" must be validated for each customer application by customer's technical experts. ON Semiconductor does not convey any license under its patent rights nor the rights of others. ON Semiconductor products are not designed, intended, or authorized for use as a critical component in life support systems or any FDA Class 3 medical devices or medical devices with a same or similar classification in a foreign jurisdiction or any devices intended for implantation in the human body. Should Buyer purchase or use ON Semiconductor products for any such unintended or unauthorized application, Buyer shall indemnify and hold ON Semiconductor and its officers, employees, subsidiaries, affiliates, and distributors harmless against all claims, costs, damages, and expenses, and reasonable attorney fees arising out of, directly or indirectly, any claim of personal injury or death associated with such unintended or unauthorized use, even if such claim alleges that ON Semiconductor was negligent regarding the design or manufacture of the part. ON Semiconductor is an Equal Opportunity/Affirmative Action Employer. This literature is subject to all applicable copyright laws and is not for resale in any manner.



FSQ0765RS

Green-Mode Fairchild Power Switch (FPS™) for Quasi-Resonant Operation - Low EMI and High Efficiency

Features

- Optimized for Quasi-Resonant Converter (QRC)
- Low EMI through Variable Frequency Control and AVS (Alternating Valley Switching)
- High Efficiency through Minimum Voltage Switching
- Narrow Frequency Variation Range over Wide Load and Input Voltage Variation
- Advanced Burst-Mode Operation for Low Standby Power Consumption
- Simple Scheme for Sync-Voltage Detection
- Pulse-by-Pulse Current Limit
- Various Protection functions: Overload Protection (OLP), Over-Voltage Protection (OVP), Abnormal Over-Current Protection (AOCP), Internal Thermal Shutdown (TSD) with Hysteresis, Output Short Protection (OSP)
- Under-Voltage Lockout (UVLO) with Hysteresis
- Internal Startup Circuit
- Internal High-Voltage Sense FET (650V)
- Built-in Soft-Start (17.5ms)

Applications

- Power Supply for LCD TV and Monitor, VCR, SVR, STB, and DVD & DVD Recorder
- Adapter

Related Resources

Visit: <http://www.fairchildsemi.com/apnotes/> for:

- AN-4134: *Design Guidelines for Off-line Forward Converters Using Fairchild Power Switch (FPS™)*
- AN-4137: *Design Guidelines for Off-line Flyback Converters Using Fairchild Power Switch (FPS™)*
- AN-4140: *Transformer Design Consideration for off-line Flyback Converters using Fairchild Power Switch (FPS™)*
- AN-4141: *Troubleshooting and Design Tips for Fairchild Power Switch (FPS™) Flyback Applications*
- AN-4145: *Electromagnetic Compatibility for Power Converters*
- AN-4147: *Design Guidelines for RCD Snubber of Flyback Converters*
- AN-4148: *Audible Noise Reduction Techniques for FPS Applications*
- AN-4150: *Design Guidelines for Flyback Converters Using FSQ-series Fairchild Power Switch (FPS™)*

Description

A Quasi-Resonant Converter (QRC) generally shows lower EMI and higher power conversion efficiency than a conventional hard-switched converter with a fixed switching frequency. The FSQ-series is an integrated Pulse-Width Modulation (PWM) controller and SenseFET specifically designed for quasi-resonant operation and Alternating Valley Switching (AVS). The PWM controller includes an integrated fixed-frequency oscillator, Under-Voltage Lockout (UVLO), Leading-Edge Blanking (LEB), optimized gate driver, internal soft-start, temperature-compensated precise current sources for a loop compensation, and self-protection circuitry. Compared with a discrete MOSFET and PWM controller solution, the FSQ-series can reduce total cost, component count, size, and weight; while simultaneously increasing efficiency, productivity, and system reliability. This device provides a basic platform for cost-effective designs of quasi-resonant switching flyback converters.

Ordering Information

Product Number	PKG. ⁽⁵⁾	Operating Temp.	Current Limit	R _{DS(ON)} Max.	Maximum Output Power ⁽¹⁾				Replaces Devices
					230V _{AC} ±15% ⁽²⁾		85-265V _{AC}		
					Adapter ⁽³⁾	Open Frame ⁽⁴⁾	Adapter ⁽³⁾	Open Frame ⁽⁴⁾	
FSQ0765RSWDTU	TO-220F-6L	-25 to +85°C	2.5A	1.6Ω	80W	90W	48W	70W	FSCM0765R FSDM07652RE

Notes:

1. The junction temperature can limit the maximum output power.
2. 230V_{AC} or 100/115V_{AC} with doubler.
3. Typical continuous power in a non-ventilated enclosed adapter measured at 50°C ambient temperature.
4. Maximum practical continuous power in an open-frame design at 50°C ambient.



Pin Configuration

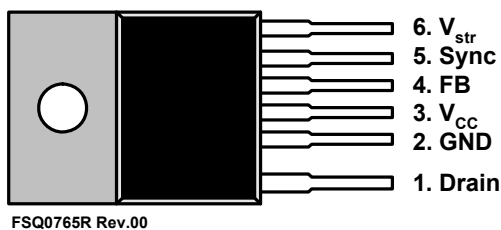

Figure 3. Pin Configuration (Top View)

Pin Definitions

Pin #	Name	Description
1	Drain	SenseFET drain. High-voltage power SenseFET drain connection.
2	GND	Ground. This pin is the control ground and the SenseFET source.
3	V_{CC}	Power Supply. This pin is the positive supply input, providing internal operating current for both startup and steady-state operation.
4	FB	Feedback. This pin is internally connected to the inverting input of the PWM comparator. The collector of an opto-coupler is typically tied to this pin. For stable operation, a capacitor should be placed between this pin and GND. If the voltage of this pin reaches 6V, the overload protection triggers, which shuts down the FPS.
5	Sync	Sync. This pin is internally connected to the sync-detect comparator for quasi-resonant switching. In normal quasi-resonant operation, the threshold of the sync comparator is 1.2V/1.0V.
6	V_{str}	Startup. This pin is connected directly, or through a resistor, to the high-voltage DC link. At startup, the internal high-voltage current source supplies internal bias and charges the external capacitor connected to the V_{CC} pin. Once V_{CC} reaches 12V, the internal current source is disabled. It is not recommended to connect V_{str} and Drain together.

Absolute Maximum Ratings

Stresses exceeding the absolute maximum ratings may damage the device. The device may not function or be operable above the recommended operating conditions and stressing the parts to these levels is not recommended. In addition, extended exposure to stresses above the recommended operating conditions may affect device reliability. The absolute maximum ratings are stress ratings only. $T_A = 25^\circ\text{C}$, unless otherwise specified.

Symbol	Parameter	Min.	Max.	Unit
V_{str}	V_{str} Pin Voltage	500		V
V_{DS}	Drain Pin Voltage	650		V
V_{CC}	Supply Voltage		20	V
V_{FB}	Feedback Voltage Range	-0.3	$V_{CC}^{(5)}$	V
V_{Sync}	Sync Pin Voltage	-0.3	13.0	V
I_{DM}	Drain Current Pulsed		14.4	A
I_D	Continuous Drain Current ⁽⁶⁾	$T_C = 25^\circ\text{C}$	3.60	A
		$T_C = 100^\circ\text{C}$	2.28	
E_{AS}	Single Pulsed Avalanche Energy ⁽⁷⁾		570	mJ
P_D	Total Power Dissipation ($T_C=25^\circ\text{C}$)		45	W
T_J	Operating Junction Temperature	Internally limited		$^\circ\text{C}$
T_A	Operating Ambient Temperature	-25	+85	$^\circ\text{C}$
T_{STG}	Storage Temperature	-55	+150	$^\circ\text{C}$
ESD	Electrostatic Discharge Protection	Human Body Model, JESD22-A114	2.0	kV
		Charged Device Model, JESD22-C101	2.0	kV

Notes:

5. Guaranteed when external current applied to FB pin is lower than 100 μA .
6. Repetitive rating: Pulse-width limited by maximum junction temperature.
7. $L=81\text{mH}$, starting $T_J=25^\circ\text{C}$.

Thermal Impedance

$T_A = 25^\circ\text{C}$ unless otherwise specified.

Symbol	Parameter	Package	Value	Unit
θ_{JA}	Junction-to-Ambient Thermal Resistance ⁽⁸⁾	TO-220F-6L	50	$^\circ\text{C/W}$
θ_{JC}	Junction-to-Case Thermal Resistance ⁽⁹⁾		2.8	$^\circ\text{C/W}$

Notes:

8. Free standing with no heat-sink under natural convection.
9. Infinite cooling condition - refer to the SEMI G30-88.

Electrical Characteristics

$T_A = 25^\circ\text{C}$ unless otherwise specified.

Symbol	Parameter	Conditions	Min.	Typ.	Max.	Units
SENSEFET SECTION						
BV_{DSS}	Drain Source Breakdown Voltage	$V_{CC} = 0V, I_D = 100\mu A$	650			V
I_{DSS}	Zero-Gate-Voltage Drain Current	$V_{DS} = 520V, V_{GS} = 0V$			300	μA
$R_{DS(ON)}$	Drain-Source On-State Resistance	$T_J = 25^\circ\text{C}, I_D = 1.8A$		1.3	1.6	Ω
C_{OSS}	Output Capacitance	$V_{GS} = 0V, V_{DS} = 25V, f = 1\text{MHz}$		125		pF
$t_{d(on)}$	Turn-On Delay Time	$V_{DD} = 325V, I_D = 6.5A$		27		ns
t_r	Rise Time			102		ns
$t_{d(off)}$	Turn-Off Delay Time			63		ns
t_f	Fall Time			65		ns
CONTROL SECTION						
$t_{ON,MAX}$	Maximum On Time	$T_J = 25^\circ\text{C}$	8.8	10.0	11.2	μs
t_B	Blanking Time	$T_J = 25^\circ\text{C}, V_{sync} = 5V$	13.2	15.0	16.8	μs
t_W	Detection Time Window	$T_J = 25^\circ\text{C}, V_{sync} = 0V$		6.0		μs
f_{SW}	Initial Switching Frequency		59.6	66.7	75.8	kHz
Δf_{SW}	Switching Frequency Variation ⁽¹¹⁾	$-25^\circ\text{C} < T_J < 85^\circ\text{C}$		± 5	± 10	%
t_{AVS}	AVS Triggering Threshold ⁽¹¹⁾	On Time		4.0		μs
V_{AVS}		Feedback Voltage	at $V_{IN} = 240V_{DC}$, $L_m = 360\mu H$ (AVS triggered when $V_{AVS} > \text{spec}$ & $t_{AVS} < \text{spec}$.)		1.2	
t_{SW}	Switching Time Variance by AVS ⁽¹¹⁾	Sync = 500kHz sine input $V_{FB} = 1.2V, t_{ON} = 4.0\mu s$	13.5		20.5	μs
I_{FB}	Feedback Source Current	$V_{FB} = 0V$	700	900	1100	μA
D_{MIN}	Minimum Duty Cycle	$V_{FB} = 0V$			0	%
V_{START}	UVLO Threshold Voltage		11	12	13	V
V_{STOP}		After turn-on	7	8	9	V
$t_{S/S}$	Internal Soft-Start Time	With free-running frequency		17.5		ms
V_{OVP}	Over-Voltage Protection		18	19	20	V
BURST-MODE SECTION						
V_{BURH}	Burst-Mode Voltages	$T_J = 25^\circ\text{C}, t_{PD} = 200\text{ns}^{(10)}$	0.45	0.55	0.65	V
V_{BURL}			0.25	0.35	0.45	V
V_{B_HYS}				200		mV

Note:

10. Propagation delay in the control IC.

Continued on the following page...

Electrical Characteristics (Continued)

 $T_A = 25^\circ\text{C}$ unless otherwise specified.

Symbol	Parameter	Conditions	Min.	Typ.	Max.	Units
PROTECTION SECTION						
I_{LIMIT}	Peak Current Limit	$T_J = 25^\circ\text{C}$, $di/dt = 460\text{mA}/\mu\text{s}$	2.20	2.50	2.80	A
V_{SD}	Shutdown Feedback Voltage	$V_{CC} = 15\text{V}$	5.5	6.0	6.5	V
I_{DELAY}	Shutdown Delay Current	$V_{FB} = 5\text{V}$	4	5	6	μA
t_{LEB}	Leading-Edge Blanking Time ⁽¹¹⁾			250		ns
t_{OSP}	Output Short Protection ⁽¹¹⁾	Threshold Time		1.2	1.4	μs
V_{OSP}		Threshold Feedback Voltage	$T_J = 25^\circ\text{C}$ OSP triggered when $t_{ON} < t_{OSP}$, $V_{FB} > V_{OSP}$ & lasts longer than t_{OSP_FB}	1.8	2.0	V
t_{OSP_FB}		Feedback Blanking Time		2.0	2.5	3.0
T_{SD}	Thermal Shutdown ⁽¹¹⁾	Shutdown Temperature		125	140	155
Hys		Hysteresis		60		
SYNC SECTION						
V_{SH1}	Sync Threshold Voltage 1	$V_{CC} = 15\text{V}$, $V_{FB} = 2\text{V}$	1.0	1.2	1.4	V
V_{SL1}			0.8	1.0	1.2	
t_{sync}	Sync Delay Time ⁽¹¹⁾⁽¹²⁾			230		ns
V_{SH2}	Sync Threshold Voltage 2	$V_{CC} = 15\text{V}$, $V_{FB} = 2\text{V}$	4.3	4.7	5.1	V
V_{SL2}			4.0	4.4	4.8	
V_{CLAMP}	Low Clamp Voltage	$I_{SYNC_MAX} = 800\mu\text{A}$ $I_{SYNC_MIN} = 50\mu\text{A}$	0.0	0.4	0.8	V
TOTAL DEVICE SECTION						
I_{OP}	Operating Supply Current (Control Part Only)	$V_{CC} = 13\text{V}$	1	3	5	mA
I_{START}	Start Current	$V_{CC} = 10\text{V}$ (before V_{CC} reaches V_{START})	350	450	550	μA
I_{CH}	Startup Charging Current	$V_{CC} = 0\text{V}$, $V_{STR} = \text{minimum } 50\text{V}$	0.65	0.85	1.00	mA
V_{STR}	Minimum V_{STR} Supply Voltage			26		V

Notes:

11. Guaranteed by design, but not tested in production.
 12. Includes gate turn-on time.

Comparison Between FSDM0x65RNB and FSQ-Series

Function	FSDM0x65RE	FSQ-Series	FSQ-Series Advantages
Operation Method	Constant Frequency PWM	Quasi-Resonant Operation	<ul style="list-style-type: none"> ■ Improved efficiency by valley switching ■ Reduced EMI noise ■ Reduced components to detect valley point
EMI Reduction	Frequency Modulation	Reduce EMI Noise	<ul style="list-style-type: none"> ■ Valley switching ■ Inherent frequency modulation ■ Alternate valley switching
Hybrid Control		CCM or AVS Based on Load and Input Condition	<ul style="list-style-type: none"> ■ Improves efficiency by introducing hybrid control
Burst-Mode Operation	Burst-Mode Operation	Advanced Burst-Mode Operation	<ul style="list-style-type: none"> ■ Improved standby power by AVS in burst-mode
Strong Protections	OLP, OVP	OLP, OVP, AOCP, OSP	<ul style="list-style-type: none"> ■ Improved reliability through precise AOCP ■ Improved reliability through precise OSP
TSD	145°C without Hysteresis	140°C with 60°C Hysteresis	<ul style="list-style-type: none"> ■ Stable and reliable TSD operation ■ Converter temperature range

Typical Performance Characteristics

These characteristic graphs are normalized at $T_A = 25^\circ\text{C}$.

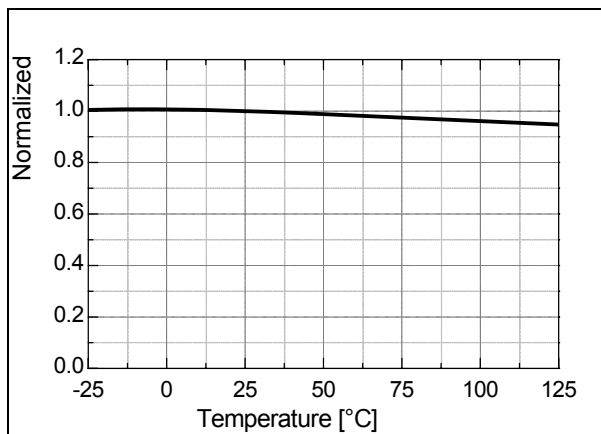

Figure 13. Operating Supply Current (I_{OP}) vs. T_A

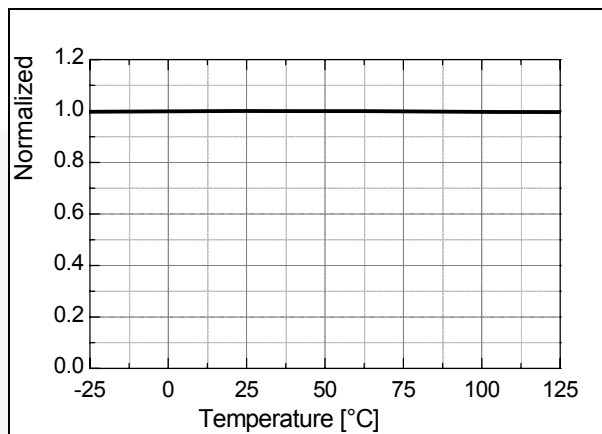

Figure 14. UVLO Start Threshold Voltage (V_{START}) vs. T_A

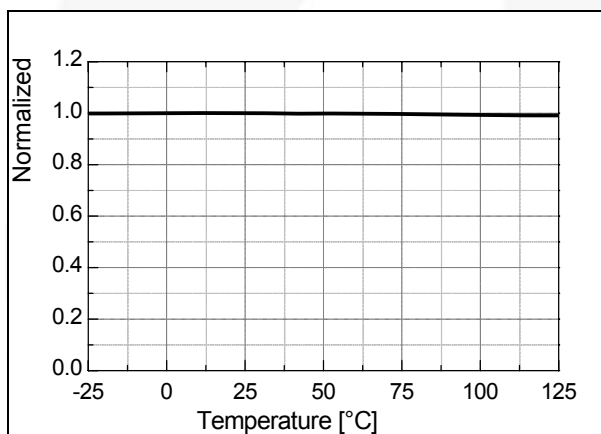

Figure 15. UVLO Stop Threshold Voltage (V_{STOP}) vs. T_A

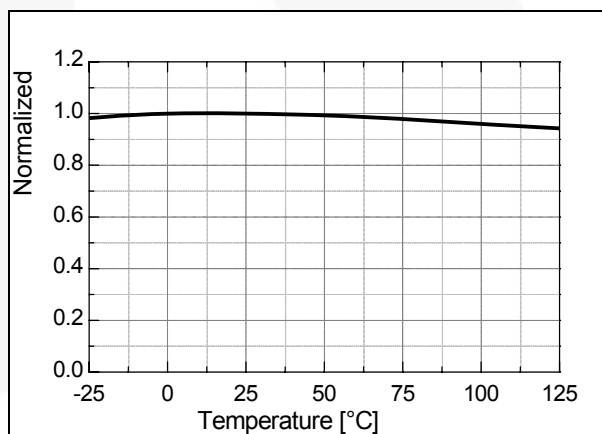

Figure 16. Startup Charging Current (I_{CH}) vs. T_A

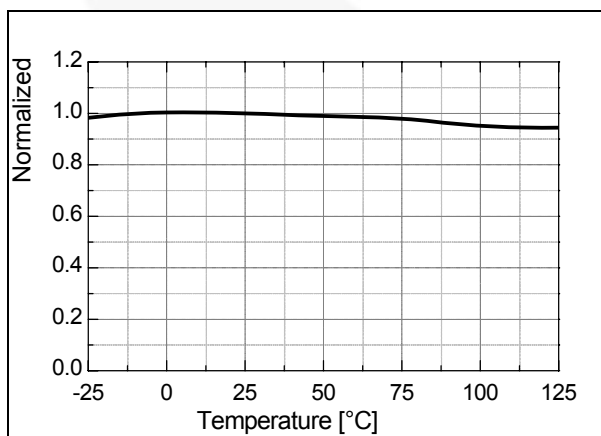

Figure 17. Initial Switching Frequency (f_{SW}) vs. T_A

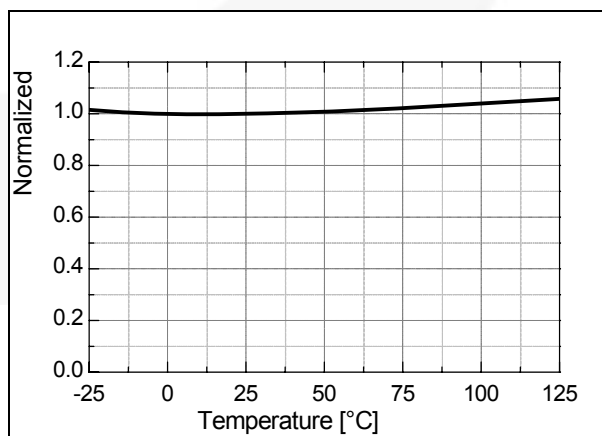

Figure 18. Maximum On Time ($t_{ON.MAX}$) vs. T_A

Typical Performance Characteristics (Continued)

These characteristic graphs are normalized at $T_A = 25^\circ\text{C}$.

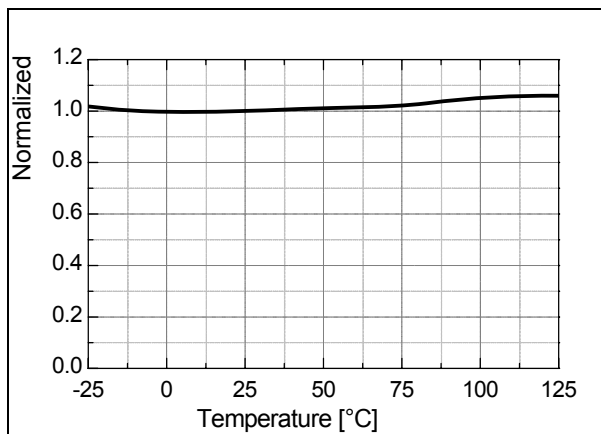

Figure 19. Blanking Time (t_B) vs. T_A

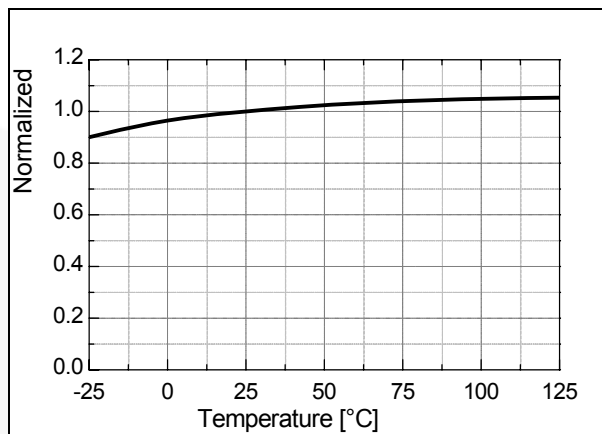

Figure 20. Feedback Source Current (I_{FB}) vs. T_A

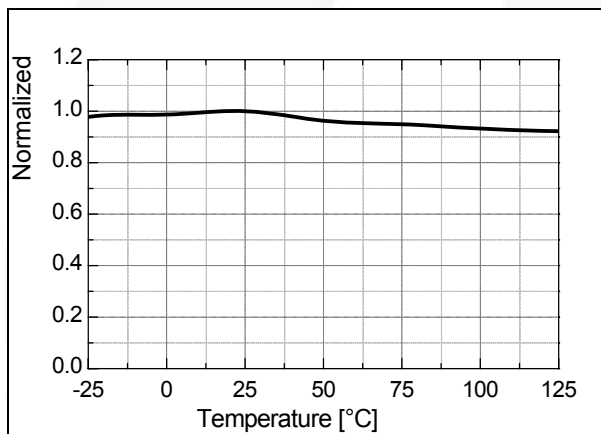

Figure 21. Shutdown Delay Current (I_{DELAY}) vs. T_A

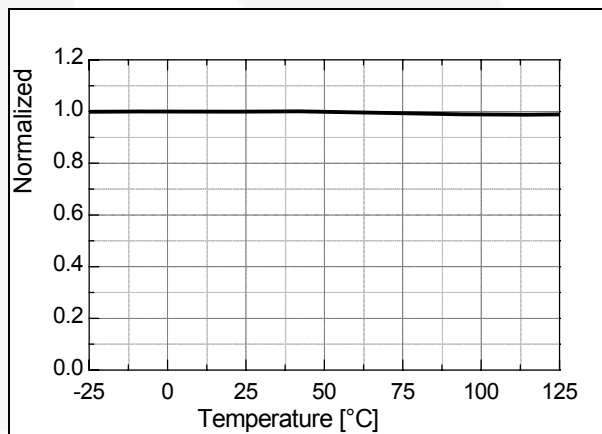

Figure 22. Burst-Mode High Threshold Voltage (V_{burh}) vs. T_A

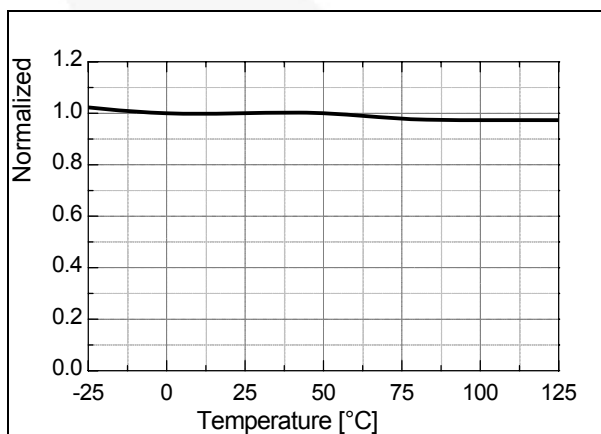

Figure 23. Burst-Mode Low Threshold Voltage (V_{burl}) vs. T_A

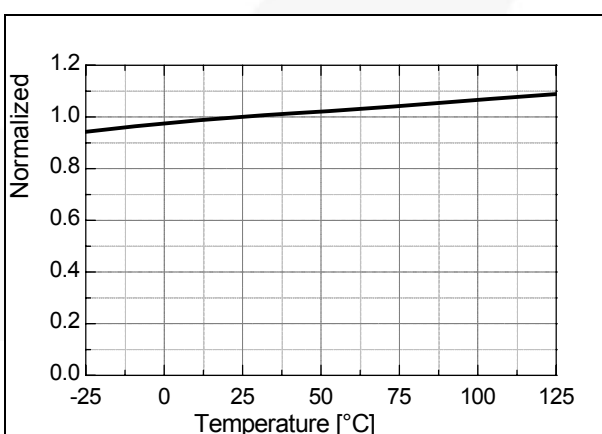

Figure 24. Peak Current Limit (I_{LIM}) vs. T_A

Typical Performance Characteristics (Continued)

These characteristic graphs are normalized at $T_A = 25^\circ\text{C}$.

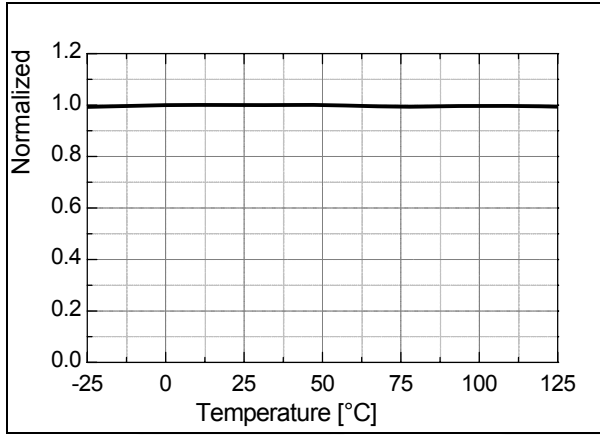

Figure 25. Sync High Threshold Voltage 1 (V_{SH1}) vs. T_A

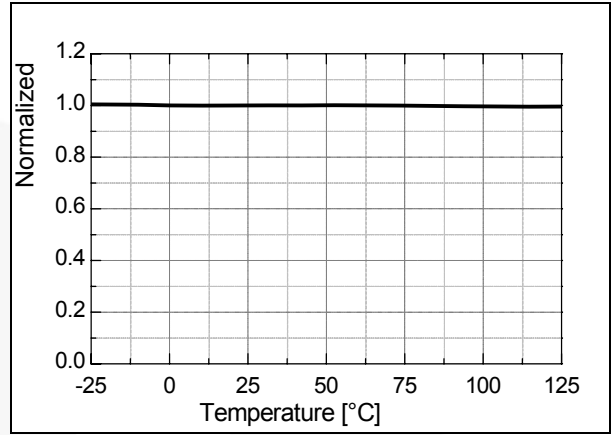

Figure 26. Sync Low Threshold Voltage 1 (V_{SL1}) vs. T_A

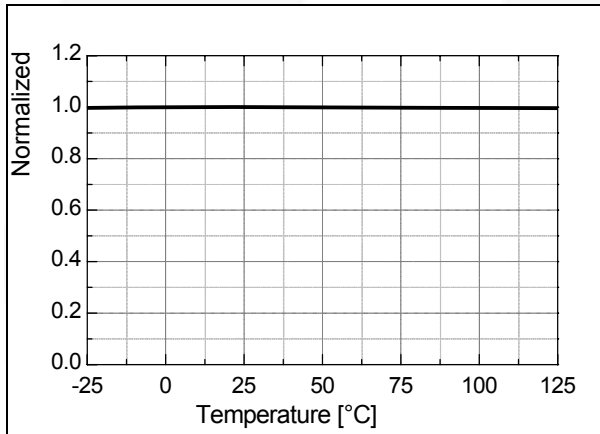

Figure 27. Shutdown Feedback Voltage (V_{SD}) vs. T_A

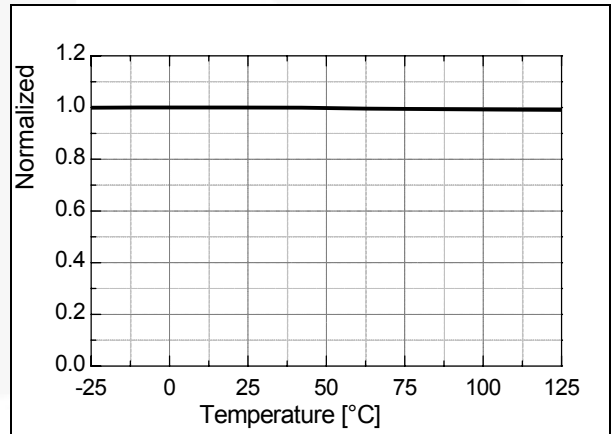

Figure 28. Over-Voltage Protection (V_{OV}) vs. T_A

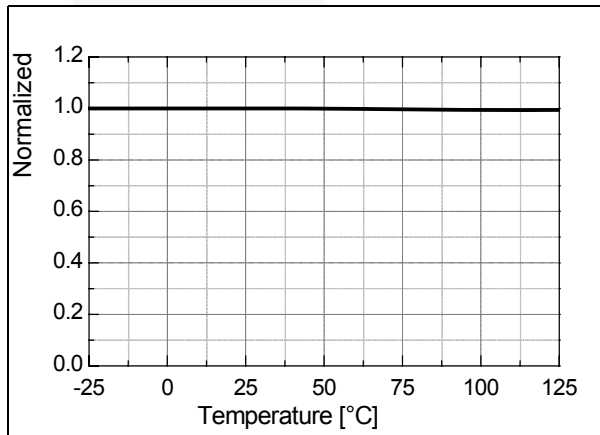

Figure 29. Sync High Threshold Voltage 2 (V_{SH2}) vs. T_A

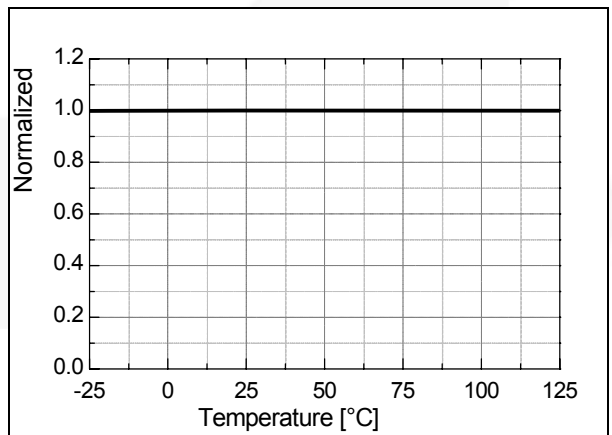

Figure 30. Sync Low Threshold Voltage 2 (V_{SL2}) vs. T_A

Functional Description

1. Startup: At startup, an internal high-voltage current source supplies the internal bias and charges the external capacitor (C_a) connected to the V_{CC} pin, as illustrated in Figure 22. When V_{CC} reaches 12V, the FPS™ begins switching and the internal high-voltage current source is disabled. The FPS continues its normal switching operation and the power is supplied from the auxiliary transformer winding unless V_{CC} goes below the stop voltage of 8V.

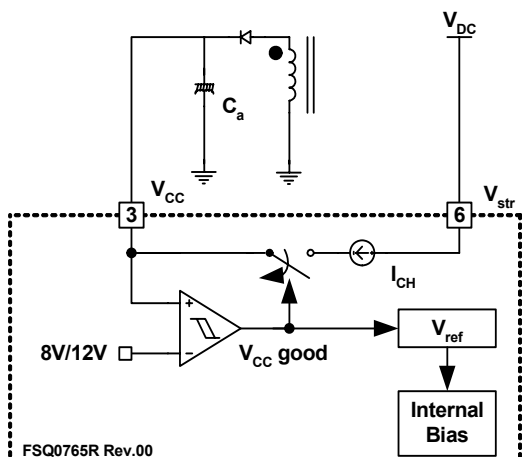

Figure 31. Startup Circuit

2. Feedback Control: FPS employs current-mode control, as shown in Figure 23. An opto-coupler (such as the FOD817A) and shunt regulator (such as the KA431) are typically used to implement the feedback network. Comparing the feedback voltage with the voltage across the R_{sense} resistor makes it possible to control the switching duty cycle. When the reference pin voltage of the shunt regulator exceeds the internal reference voltage of 2.5V, the opto-coupler LED current increases, pulling down the feedback voltage and reducing the duty cycle. This typically happens when the input voltage is increased or the output load is decreased.

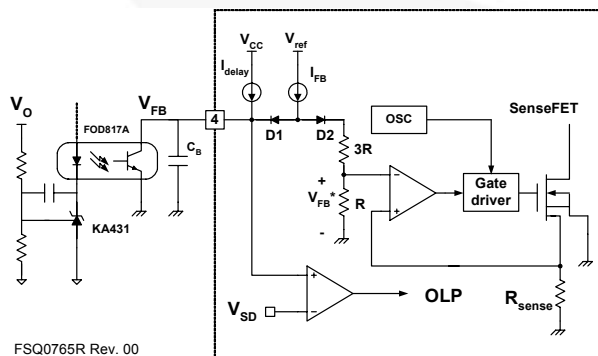

Figure 32. Pulse-Width-Modulation (PWM) Circuit

2.1 Pulse-by-Pulse Current Limit: Because current-mode control is employed, the peak current through the SenseFET is limited by the inverting input of PWM comparator (V_{FB}^*), as shown in Figure 23. Assuming that the 0.9mA current source flows only through the internal resistor ($3R + R = 2.8k$), the cathode voltage of diode D2 is about 2.5V. Since D1 is blocked when the feedback voltage (V_{FB}) exceeds 2.5V, the maximum voltage of the cathode of D2 is clamped at this voltage, clamping V_{FB}^* . Therefore, the peak value of the current through the SenseFET is limited.

2.2 Leading-Edge Blanking (LEB): At the instant the internal SenseFET is turned on, a high-current spike usually occurs through the SenseFET, caused by primary-side capacitance and secondary-side rectifier reverse recovery. Excessive voltage across the R_{sense} resistor would lead to incorrect feedback operation in the current-mode PWM control. To counter this effect, the FPS employs a leading-edge blanking (LEB) circuit. This circuit inhibits the PWM comparator for a short time (t_{LEB}) after the SenseFET is turned on in the Pulse-Width-Modulation (PWM) circuit.

3. Synchronization: The FSQ-series employs a quasi-resonant switching technique to minimize the switching noise and loss. The basic waveforms of the quasi-resonant converter are shown in Figure 24. To minimize the MOSFET's switching loss, the MOSFET should be turned on when the drain voltage reaches its minimum value, which is indirectly detected by monitoring the V_{CC} winding voltage, as shown in Figure 24.

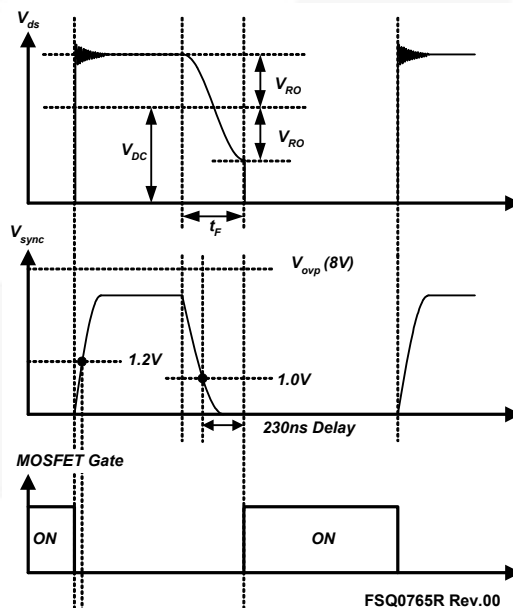

Figure 33. Quasi-Resonant Switching Waveforms

The switching frequency is the combination of blank time (t_B) and detection time window (t_W). In case of a heavy load, the sync voltage remains flat after t_B and waits for valley detection during t_W . This leads to a low switching frequency not suitable for heavy loads. To correct this drawback, additional timing is used. The timing conditions are described in Figures 25, 26, and 27. When the V_{sync} remains flat higher than 4.4V at the end of t_B which is instant t_x , the next switching cycle starts after internal delay time from t_x . In the second case, the next switching occurs on the valley when the V_{sync} goes below 4.4V within t_B . Once V_{sync} detects the first valley in t_B , the other switching cycle follows classical QRC operation.

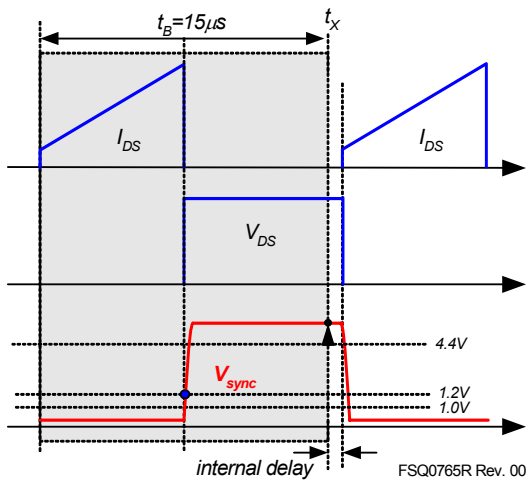

Figure 34. $V_{sync} > 4.4V$ at t_x

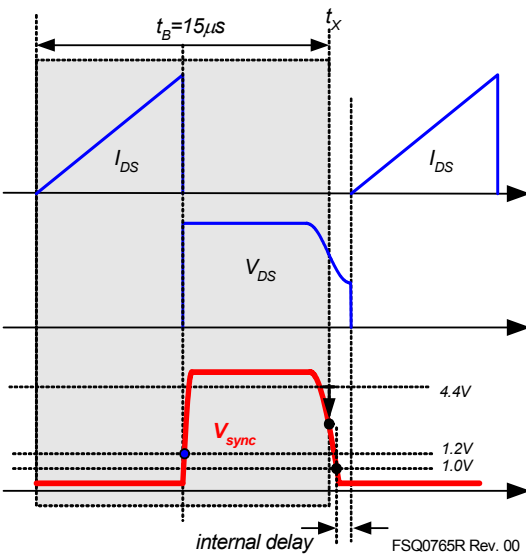

Figure 35. $V_{sync} < 4.4V$ at t_x

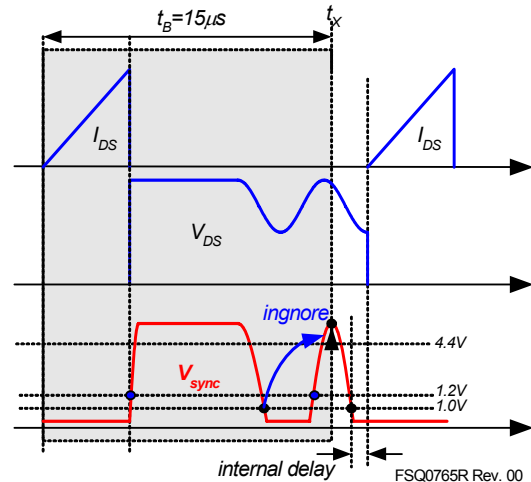

Figure 36. After V_{sync} Finds First Valley

4. Protection Circuits: The FSQ-series has several self-protective functions, such as Overload Protection (OLP), Abnormal Over-Current Protection (AOCP), Over-Voltage Protection (OVP), and Thermal Shutdown (TSD). All the protections are implemented as auto-restart mode. Once the fault condition is detected, switching is terminated and the SenseFET remains off. This causes V_{CC} to fall. When V_{CC} falls down to the Under-Voltage Lockout (UVLO) stop voltage of 8V, the protection is reset and the startup circuit charges the V_{CC} capacitor. When the V_{CC} reaches the start voltage of 12V, normal operation resumes. If the fault condition is not removed, the SenseFET remains off and V_{CC} drops to stop voltage again. In this manner, the auto-restart can alternately enable and disable the switching of the power SenseFET until the fault condition is eliminated. Because these protection circuits are fully integrated into the IC without external components, the reliability is improved without increasing cost.

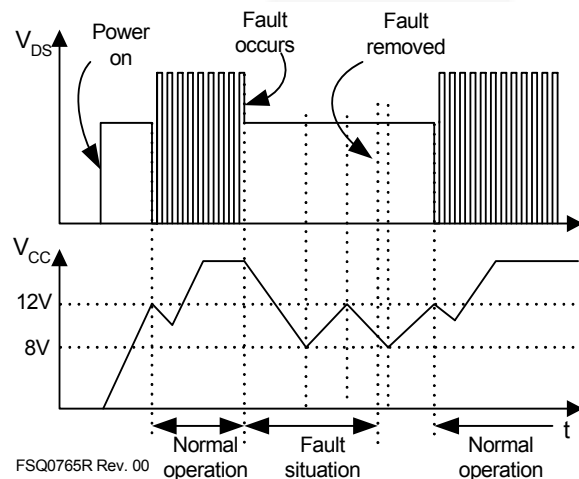

Figure 37. Auto-Restart Protection Waveforms

4.1 Overload Protection (OLP): Overload is defined as the load current exceeding its normal level due to an unexpected abnormal event. In this situation, the protection circuit should trigger to protect the SMPS. However, even when the SMPS is in the normal operation, the overload protection circuit can be triggered during the load transition. To avoid this undesired operation, the overload protection circuit is designed to trigger only after a specified time to determine whether it is a transient situation or a true overload situation. Because of the pulse-by-pulse current limit capability, the maximum peak current through the SenseFET is limited, and therefore the maximum input power is restricted with a given input voltage. If the output consumes more than this maximum power, the output voltage (V_O) decreases below the set voltage. This reduces the current through the opto-coupler LED, which also reduces the opto-coupler transistor current, thus increasing the feedback voltage (V_{FB}). If V_{FB} exceeds 2.5V, D1 is blocked and the 5 μ A current source starts to charge CB slowly up to V_{CC} . In this condition, V_{FB} continues increasing until it reaches 6V, when the switching operation is terminated, as shown in Figure 29. The delay time for shutdown is the time required to charge C_{FB} from 2.5V to 6V with 5 μ A. A 20 ~ 50ms delay time is typical for most applications.

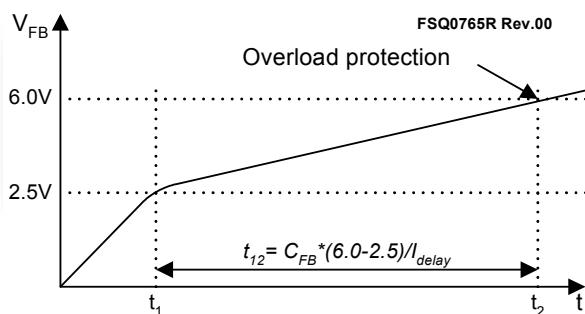

Figure 38. Overload Protection

4.2 Abnormal Over-Current Protection (AOCP): When the secondary rectifier diodes or the transformer pins are shorted, a steep current with extremely high di/dt can flow through the SenseFET during the LEB time. Even though the FSQ-series has overload protection, it is not enough to protect the FSQ-series in that abnormal case, since severe current stress is imposed on the SenseFET until OLP triggers. The FSQ-series has an internal AOCP circuit shown in Figure 30. When the gate turn-on signal is applied to the power SenseFET, the AOCP block is enabled and monitors the current through the sensing resistor. The voltage across the resistor is compared with a preset AOCP level. If the sensing resistor voltage is greater than the AOCP level, the set signal is applied to the latch, resulting in the shutdown of the SMPS.

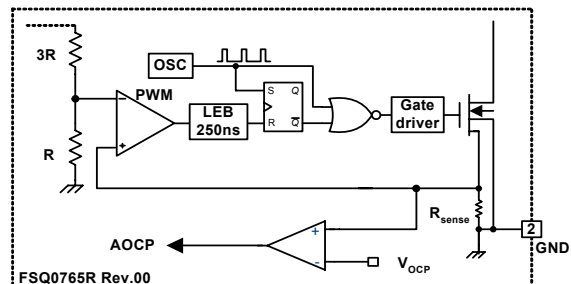

Figure 39. Abnormal Over-Current Protection

4.3 Output-Short Protection (OSP): If the output is shorted, steep current with extremely high di/dt can flow through the SenseFET during the LEB time. Such a steep current brings high voltage stress on drain of SenseFET when turned off. To protect the device from such an abnormal condition, OSP is included in the FSQ-series. It is comprised of detecting V_{FB} and SenseFET turn-on time. When the V_{FB} is higher than 2V and the SenseFET turn-on time is lower than 1.2 μ s, the FPS recognizes this condition as an abnormal error and shuts down PWM switching until V_{CC} reaches V_{start} again. An abnormal condition output short is shown in Figure 31.

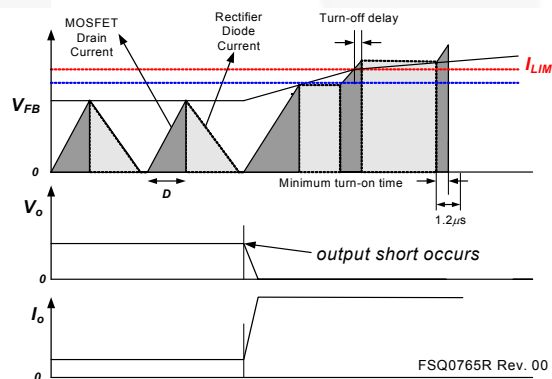

Figure 40. Output Short Waveforms

4.4 Over-Voltage Protection (OVP): If the secondary-side feedback circuit malfunctions or a solder defect caused an open in the feedback path, the current through the opto-coupler transistor becomes almost zero. Then, V_{FB} climbs up in a similar manner to the overload situation, forcing the preset maximum current to be supplied to the SMPS until overload protection is activated. Because more energy than required is provided to the output, the output voltage may exceed the rated voltage before overload protection is activated, resulting in the breakdown of the devices in the secondary side. To prevent this situation, an over-voltage protection (OVP) circuit is employed. In general, V_{CC} is proportional to the output voltage and the FSQ-series

uses V_{CC} instead of directly monitoring the output voltage. If V_{CC} exceeds 19V, an OVP circuit is activated resulting in the termination of the switching operation. To avoid undesired activation of OVP during normal operation, V_{CC} should be designed to be below 19V.

4.5 Thermal Shutdown with Hysteresis (TSD): The SenseFET and the control IC are built in one package. This enables the control IC to detect the abnormally high temperature of the SenseFET. If the temperature exceeds approximately 140°C, the thermal shutdown triggers IC shutdown. The IC recovers its operation when the junction temperature decreases 60°C from TSD temperature and V_{CC} reaches startup voltage (V_{start}).

5. Soft-Start: The FPS has an internal soft-start circuit that increases PWM comparator inverting input voltage with the SenseFET current slowly after it starts up. The typical soft-start time is 17.5ms. The pulse width to the power-switching device is progressively increased to establish the correct working conditions for transformers, inductors, and capacitors. The voltage on the output capacitors is progressively increased with the intention of smoothly establishing the required output voltage. This mode helps prevent transformer saturation and reduces stress on the secondary diode during startup.

6. Burst Operation: To minimize power dissipation in standby mode, the FPS enters burst-mode operation. As the load decreases, the feedback voltage decreases. As shown in Figure 32, the device automatically enters burst-mode when the feedback voltage drops below V_{BURL} (350mV). At this point, switching stops and the output voltages start to drop at a rate dependent on standby current load. This causes the feedback voltage to rise. Once it passes V_{BURH} (550mV), switching resumes. The feedback voltage then falls and the process repeats. Burst-mode operation alternately enables and disables switching of the power SenseFET, thereby reducing switching loss in standby mode.

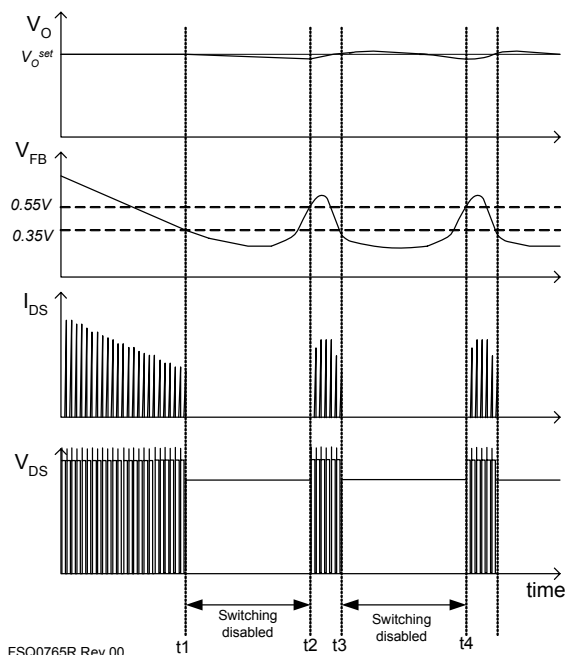

Figure 41. Waveforms of Burst Operation

7. Switching Frequency Limit: To minimize switching loss and Electromagnetic Interference (EMI), the MOSFET turns on when the drain voltage reaches its minimum value in quasi-resonant operation. However, this causes switching-frequency to increase at light-load conditions. As the load decreases or input voltage increases, the peak drain current diminishes and the switching frequency increases. This results in severe switching losses at light-load condition, as well as intermittent switching and audible noise. These problems create limitations for the quasi-resonant converter topology in a wide range of applications.

To overcome these problems, FSQ-series employs a frequency-limit function, as shown in Figures 34 and 35. Once the SenseFET is turned on, the next turn-on is prohibited during the blanking time (t_B). After the blanking time, the controller finds the valley within the detection time window (t_{WV}) and turns on the MOSFET, as shown in Figures 33 and Figure 34 (Cases A, B, and C). If no valley is found during t_{WV} , the internal SenseFET is forced to turn on at the end of t_{WV} (Case D). Therefore, the devices have a minimum switching frequency of 48kHz and a maximum switching frequency of 67kHz.

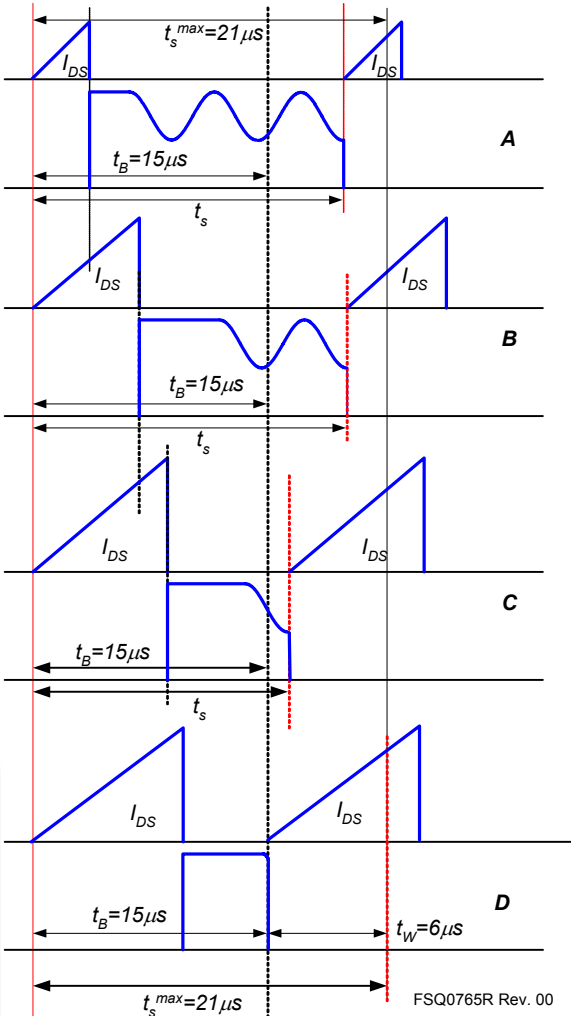

Figure 42. QRC Operation with Limited Frequency

8. AVS (Alternating Valley Switching): Due to the quasi-resonant operation with limited frequency, the switching frequency varies depending on input voltage, load transition, and so on. At high input voltage, the switching on time is relatively small compared to low input voltage. The input voltage variance is small and the switching-frequency modulation width becomes small. To improve the EMI performance, AVS is enabled when input voltage is high and the switching on time is small.

Internally, quasi-resonant operation is divided into two categories; one is first valley switching and the other is second-valley switching after blanking time. In AVS, two successive occurrences of first-valley switching and the other two successive occurrences of second-valley switching is alternatively selected to maximize frequency modulation. As depicted in Figure 34, the switching frequency hops when the input voltage is high. The internal timing diagram of AVS is described in Figure 35.

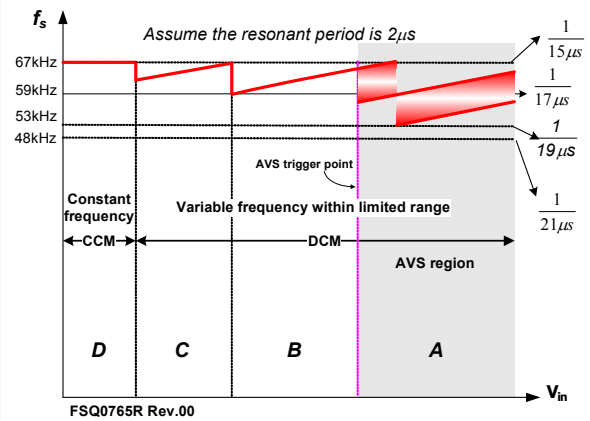

Figure 43. Switching Frequency Range

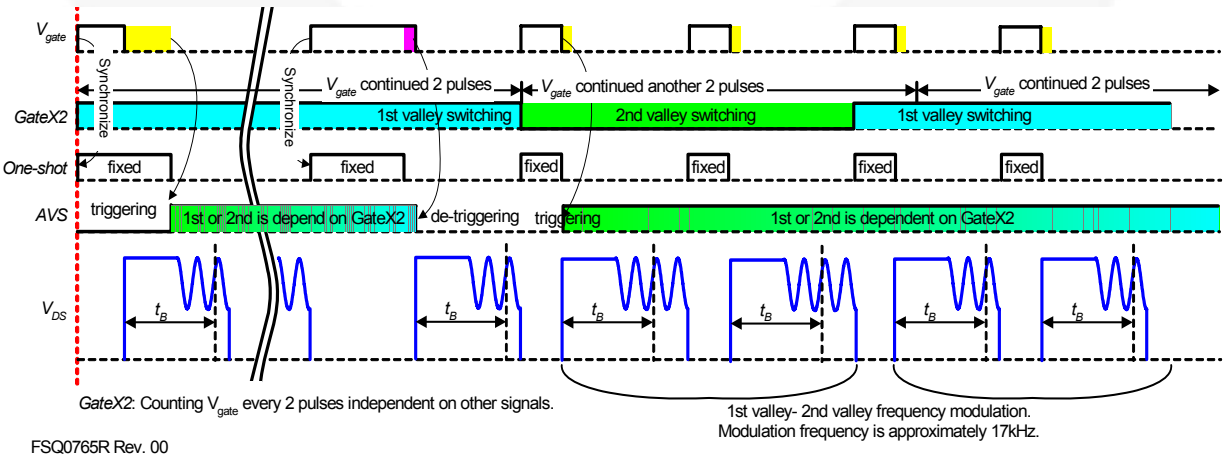

Figure 44. Alternating Valley Switching (AVS)

PCB Layout Guide

Due to the combined scheme, FPS shows better noise immunity than a conventional PWM controller and MOSFET discrete solution. Furthermore, internal drain current sense eliminates noise generation caused by a sensing resistor. There are some recommendations for PCB layout to enhance noise immunity and suppress the noise inevitable in power-handling components.

There are typically two grounds in the conventional SMPS: power ground and signal ground. The power ground is the ground for primary input voltage and power, while the signal ground is the ground for PWM controller. In FPS, those two grounds share the same pin, GND. Normally the separate grounds do not share the same trace and meet only at one point, the GND pin. Moreover, wider patterns for both grounds decrease resistance for large currents.

Capacitors at the V_{CC} and FB pins should be as close as possible to the corresponding pins to avoid noise from the switching device. Sometimes Mylar® or ceramic capacitors with electrolytic for V_{CC} are better for smooth operation. The ground of these capacitors needs to connect to the signal ground (not power ground).

The cathode of the snubber diode should be close to the drain pin to minimize stray inductance. The Y-capacitor between primary and secondary should be directly connected to the power ground of DC link to maximize surge immunity.

Because the voltage range of feedback and sync line is small, it is affected by the noise of the drain pin. Those traces should not draw across or close to the drain line.

When the heat sink is connected to the ground, it should be connected to the power ground. If possible, avoid using jumper wires for power ground and drain.



Figure 45. Recommended PCB Layout

Mylar® is a registered trademark of DuPont Teijin Films.

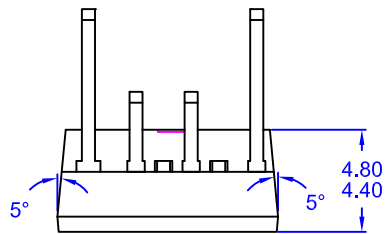
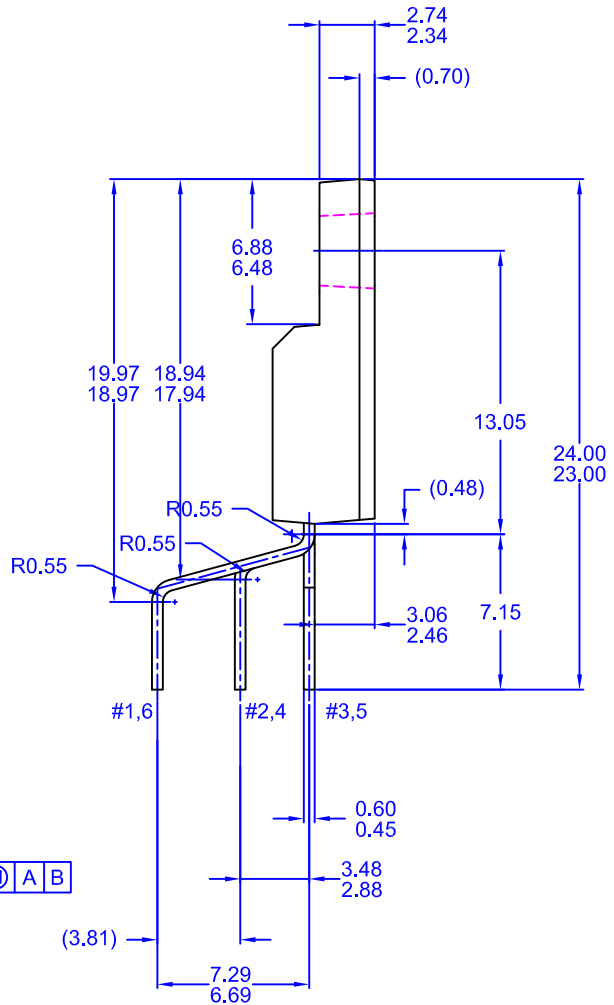
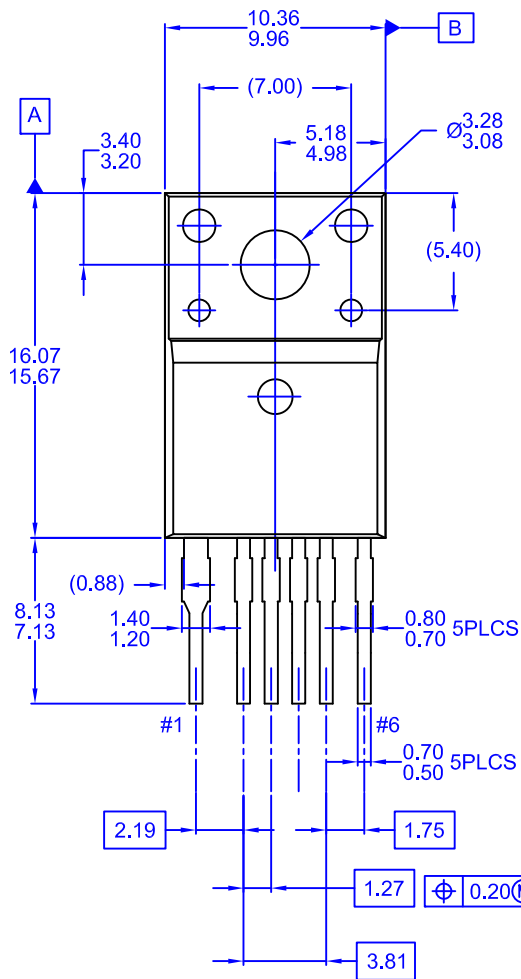

NOTES:

- A) NO PACKAGE STANDARD APPLIES.
- B) DIMENSIONS ARE EXCLUSIVE OF BURRS, MOLD FLASH, AND TIE BAR EXTRUSIONS.
- C) DIMENSIONS ARE IN MILLIMETERS.
- D) DRAWING FILENAME : MKT-TO220F06REV3



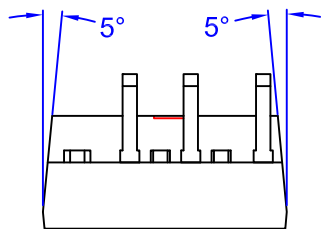
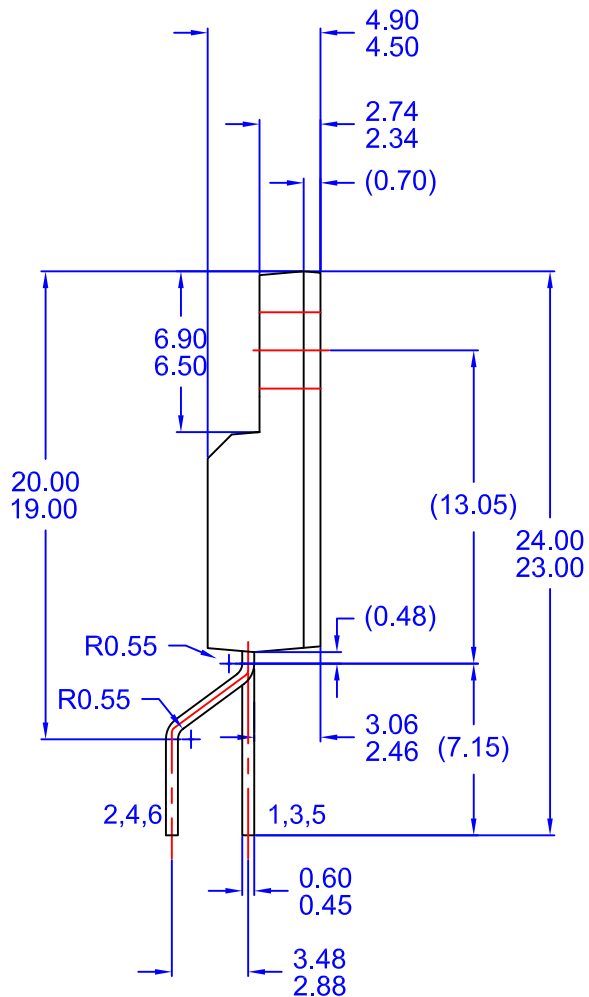
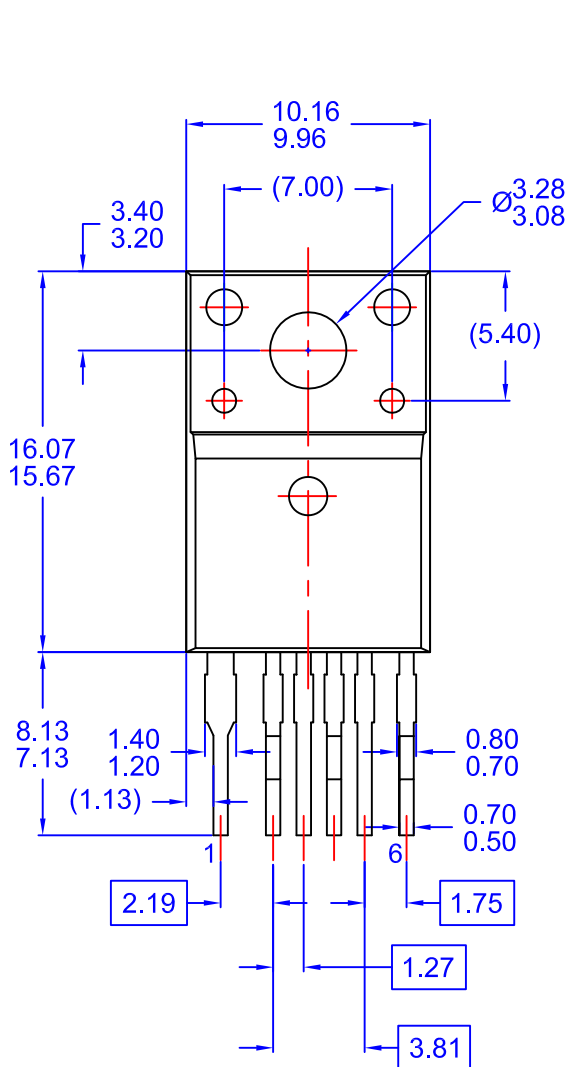

- NOTES: UNLESS OTHERWISE SPECIFIED
 A) THIS PACKAGE DOES NOT COMPLY TO ANY CURRENT PACKAGING STANDARD.
 B) ALL DIMENSIONS ARE IN MILLIMETERS.
 C) DIMENSIONS ARE EXCLUSIVE OF BURRS, MOLD FLASH, AND TIE BAR EXTRUSIONS.
 D) LEADFORM OPTION A
 E) DRAWING FILENAME: TO220A06REV5



ON Semiconductor and  are trademarks of Semiconductor Components Industries, LLC dba ON Semiconductor or its subsidiaries in the United States and/or other countries. ON Semiconductor owns the rights to a number of patents, trademarks, copyrights, trade secrets, and other intellectual property. A listing of ON Semiconductor's product/patent coverage may be accessed at www.onsemi.com/site/pdf/Patent-Marking.pdf. ON Semiconductor reserves the right to make changes without further notice to any products herein. ON Semiconductor makes no warranty, representation or guarantee regarding the suitability of its products for any particular purpose, nor does ON Semiconductor assume any liability arising out of the application or use of any product or circuit, and specifically disclaims any and all liability, including without limitation special, consequential or incidental damages. Buyer is responsible for its products and applications using ON Semiconductor products, including compliance with all laws, regulations and safety requirements or standards, regardless of any support or applications information provided by ON Semiconductor. "Typical" parameters which may be provided in ON Semiconductor data sheets and/or specifications can and do vary in different applications and actual performance may vary over time. All operating parameters, including "Typicals" must be validated for each customer application by customer's technical experts. ON Semiconductor does not convey any license under its patent rights nor the rights of others. ON Semiconductor products are not designed, intended, or authorized for use as a critical component in life support systems or any FDA Class 3 medical devices or medical devices with a same or similar classification in a foreign jurisdiction or any devices intended for implantation in the human body. Should Buyer purchase or use ON Semiconductor products for any such unintended or unauthorized application, Buyer shall indemnify and hold ON Semiconductor and its officers, employees, subsidiaries, affiliates, and distributors harmless against all claims, costs, damages, and expenses, and reasonable attorney fees arising out of, directly or indirectly, any claim of personal injury or death associated with such unintended or unauthorized use, even if such claim alleges that ON Semiconductor was negligent regarding the design or manufacture of the part. ON Semiconductor is an Equal Opportunity/Affirmative Action Employer. This literature is subject to all applicable copyright laws and is not for resale in any manner.

PUBLICATION ORDERING INFORMATION

LITERATURE FULFILLMENT:

Literature Distribution Center for ON Semiconductor
19521 E. 32nd Pkwy, Aurora, Colorado 80011 USA
Phone: 303-675-2175 or 800-344-3860 Toll Free USA/Canada
Fax: 303-675-2176 or 800-344-3867 Toll Free USA/Canada
Email: orderlit@onsemi.com

N. American Technical Support: 800-282-9855 Toll Free
USA/Canada
Europe, Middle East and Africa Technical Support:
Phone: 421 33 790 2910
Japan Customer Focus Center
Phone: 81-3-5817-1050

ON Semiconductor Website: www.onsemi.com
Order Literature: <http://www.onsemi.com/orderlit>
For additional information, please contact your local
Sales Representative

Mouser Electronics

Authorized Distributor

Click to View Pricing, Inventory, Delivery & Lifecycle Information:

[ON Semiconductor:](#)

[FSQ0765RSLDTU](#) [FSQ0765RSUDTU](#) [FSQ0765RSWDTU](#)

Компания «Океан Электроники» предлагает заключение долгосрочных отношений при поставках импортных электронных компонентов на взаимовыгодных условиях!

Наши преимущества:

- Поставка оригинальных импортных электронных компонентов напрямую с производств Америки, Европы и Азии, а так же с крупнейших складов мира;
- Широкая линейка поставок активных и пассивных импортных электронных компонентов (более 30 млн. наименований);
- Поставка сложных, дефицитных, либо снятых с производства позиций;
- Оперативные сроки поставки под заказ (от 5 рабочих дней);
- Экспресс доставка в любую точку России;
- Помощь Конструкторского Отдела и консультации квалифицированных инженеров;
- Техническая поддержка проекта, помощь в подборе аналогов, поставка прототипов;
- Поставка электронных компонентов под контролем ВП;
- Система менеджмента качества сертифицирована по Международному стандарту ISO 9001;
- При необходимости вся продукция военного и аэрокосмического назначения проходит испытания и сертификацию в лаборатории (по согласованию с заказчиком);
- Поставка специализированных компонентов военного и аэрокосмического уровня качества (Xilinx, Altera, Analog Devices, Intersil, Interpoint, Microsemi, Actel, Aeroflex, Peregrine, VPT, Syfer, Eurofarad, Texas Instruments, MS Kennedy, Miteq, Cobham, E2V, MA-COM, Hittite, Mini-Circuits, General Dynamics и др.);

Компания «Океан Электроники» является официальным дистрибьютором и эксклюзивным представителем в России одного из крупнейших производителей разъемов военного и аэрокосмического назначения «JONHON», а так же официальным дистрибьютором и эксклюзивным представителем в России производителя высокотехнологичных и надежных решений для передачи СВЧ сигналов «FORSTAR».



JONHON

«JONHON» (основан в 1970 г.)

Разъемы специального, военного и аэрокосмического назначения:

(Применяются в военной, авиационной, аэрокосмической, морской, железнодорожной, горно- и нефтедобывающей отраслях промышленности)

«FORSTAR» (основан в 1998 г.)

ВЧ соединители, коаксиальные кабели, кабельные сборки и микроволновые компоненты:

(Применяются в телекоммуникациях гражданского и специального назначения, в средствах связи, РЛС, а так же военной, авиационной и аэрокосмической отраслях промышленности).



Телефон: 8 (812) 309-75-97 (многоканальный)

Факс: 8 (812) 320-03-32

Электронная почта: ocean@oceanchips.ru

Web: <http://oceanchips.ru/>

Адрес: 198099, г. Санкт-Петербург, ул. Калинина, д. 2, корп. 4, лит. А