

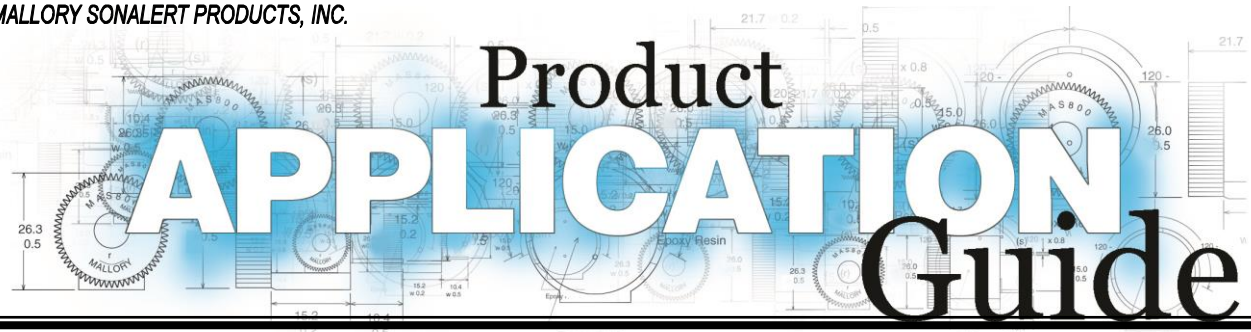

MALLORY SONALERT PRODUCTS, INC.



## Product Application Guide- Transducers- External Drive- Piezo

### Part Numbering System Transducer Series (PT / AST)

Part Number Structure PT - 1224 P E-05 Q

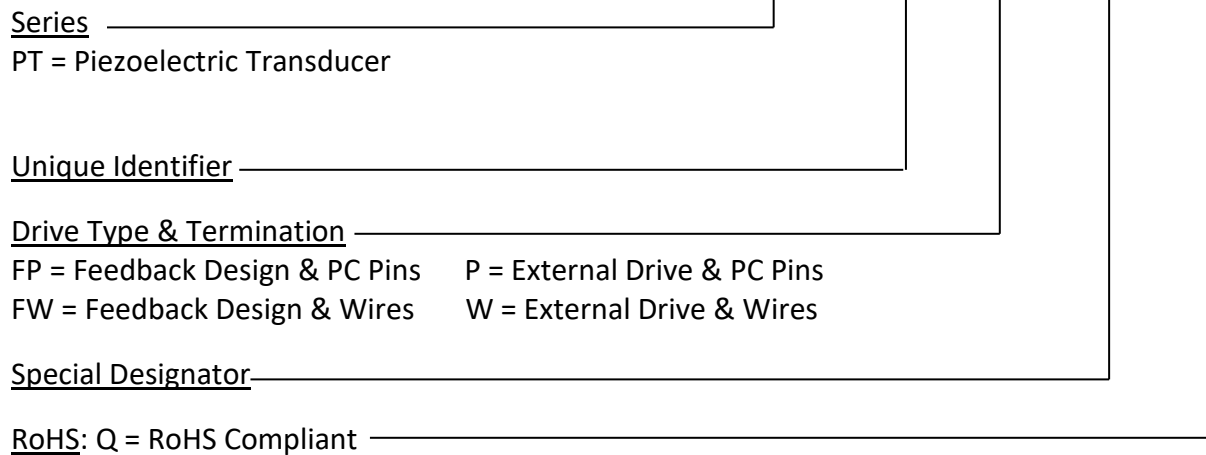

Part Number Structure AST 605 TR Q

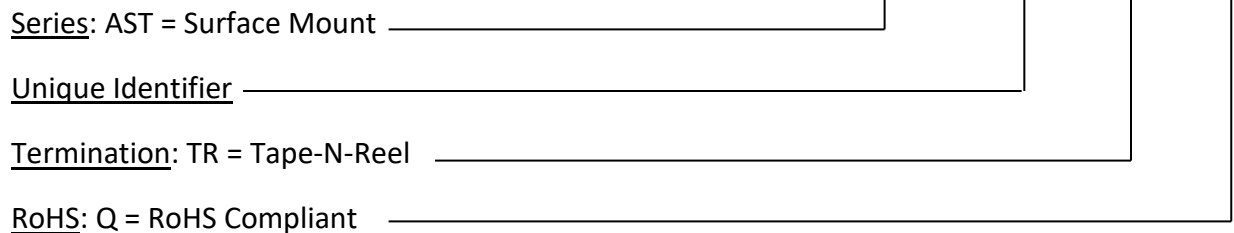

## Piezoelectric Electronic Alarm Construction

Piezoelectric Audible Signal Basic Construction

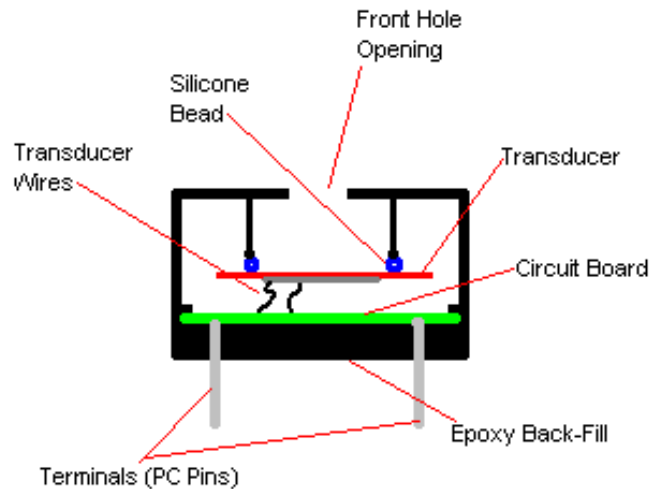

The above cross section picture shows the basic elements used in a piezoelectric audible alarm. The area in front of the transducer element including the front hole opening forms an acoustic cavity that lets the sound radiate out with the most efficiency (i.e. loudest sound level). If the alarm is an indicator that contains a circuit board, the circuit board is attached to the piezoelectric sounder element via soldered wires.

The above picture can be interpreted to represent a board mount package with pc pin terminations, but the same concept is used when building audible alarms in other mounting configurations such as SMT, Flange Mount, and Panel Mount alarms.

If the back of the alarm is sealed with epoxy or other material, the “guts” of the alarm (including the circuit board and components) are protected against fluid intrusion. However, fluid sitting inside the front cavity can obstruct the operation of the device causing the sound level to decrease significantly. If you need to wash the alarms after a soldering operation, it is strongly recommended to use an alarm that comes with a wash label that keeps the washing fluid from getting inside of the front cavity.

## Operation of Piezoelectric Audible Alarms

Piezoelectric electronic audible alarms work by converting the user input voltage to an appropriate oscillating signal that is applied to a sounder element that is mounted in a housing. The piezoelectric sounder element consists of a metal disc that has a special ceramic material

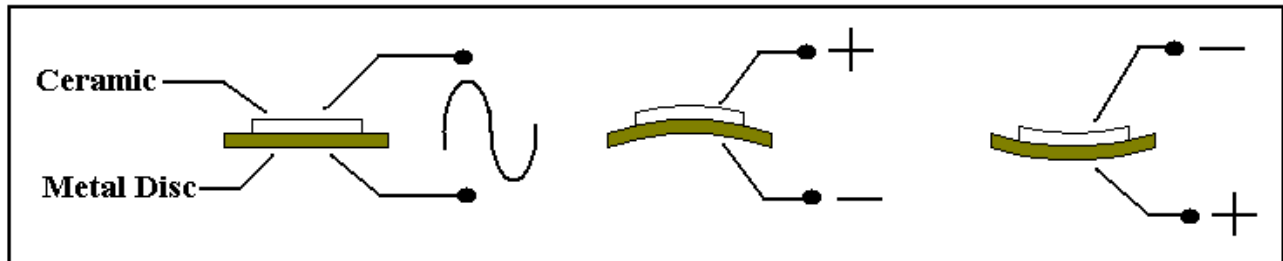

bonded to it that physically bends when voltage is applied to it.

The above picture shows a bare piezoelectric sounder element. By applying a sinusoidal wave-form at an appropriate frequency, the transducer will physically deflect in one direction and then in the opposite direction following the shape of the input wave-form. If this oscillation occurs in the audible frequency range (1 Hz to 20 kHz), then air pressure waves are produced that the human ear interprets as an audible sound.

The larger the voltage of the applied wave-form, the larger the amplitude of the air pressure waves resulting in a louder sound level. However, the ceramic portion of the transducer can only bend so far before there is a risk of a catastrophic failure. This maximum voltage is somewhere around 40 to 50 volts. However, it is rare to apply this much voltage to a transducer as you reach a point of diminishing returns for voltages much greater than 32 volts.

By itself, the sound level produced by a transducer element is insignificant. To increase the size of the air pressure waves (and thus the sound level), the transducer element must be mounted inside an acoustic chamber that is optimized for the transducer size and resonant frequency. Every transducer has one frequency where it flexes more efficiently producing the louder sound levels. This frequency where the transducer performs the best is called the resonant frequency.

Self-Drive type devices provide a 3<sup>rd</sup> terminal that connects to an isolated portion of the piezoelectric transducer. This third terminal provides a feed-back signal that is 180 degrees out of phase with the drive signal. This signal can be fed back into the circuit to allow the sounder element to self-tune itself to the transducer's resonant frequency.

## Decibel Sound Level Scale

The decibel sound level scale is an arbitrary scale that ranges from 0 dB (threshold of hearing) to 130 dB (threshold of pain). The chart below shows where some common sounds fall on this dB scale. Audible alarms are available that have sound levels as soft as 55 dB at 2 feet and as loud as 110 dB at 2 feet.

### Reference Sound Levels

(as if you were standing 2 feet from the sound source)

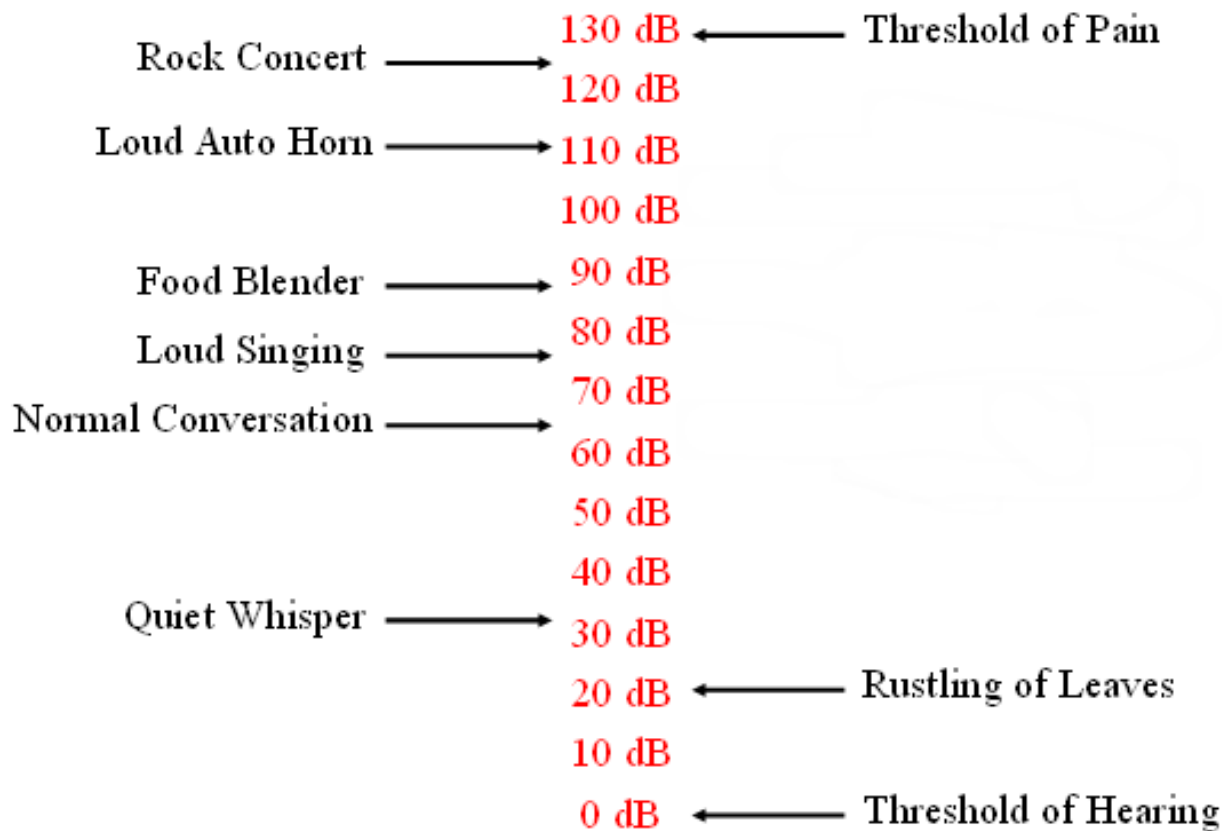

## Fundamental Frequency & Harmonics

Below is a frequency scan of a piezoelectric audible alarm that has a resonant frequency of 2,800 Hz. As you can see, there is a strong frequency peak at 2.8 kHz and several smaller frequency peaks that follow called harmonic frequencies. The table below the chart shows that the size of the harmonic frequencies are significantly smaller than the fundamental frequency for this particular alarm unit. Because this alarm has a large fundamental frequency and much smaller harmonic frequencies, the sound quality of this part will be very good. When this alarm is activated, the listener will hear one clear frequency (also called sound pitch) from the alarm. Other electronic alarm technologies such as electro-magnetic or electro-mechanical type alarms often have much larger harmonic frequency components resulting in less clear tone.

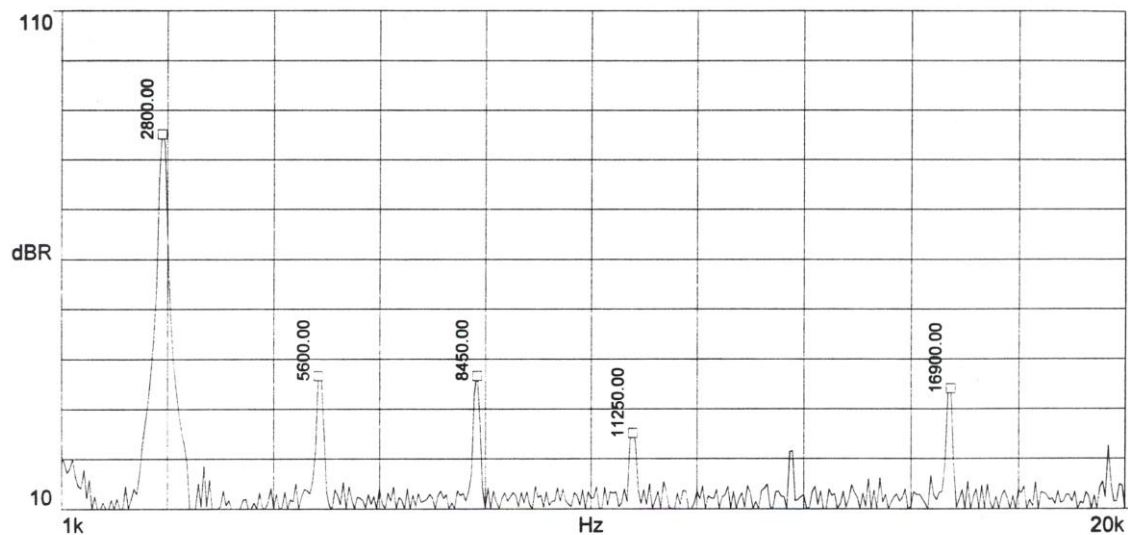

	Frequency	dB	% dB of Fundamental
Fundamental:	2.800 KHz	86.1	100.0%
2nd Harmonic:	5.600 KHz	37.6	43.7%
3rd Harmonic:	8.450 KHz	37.6	43.7%
4th Harmonic:	11.250 KHz	26.1	30.3%

## Controlling Sound Level- Electronic Method

For piezoelectric type audible alarms, the larger the voltage signal applied to the piezoelectric transducer, the louder the sound level. This property can be used to electronically control the sound level of these devices.

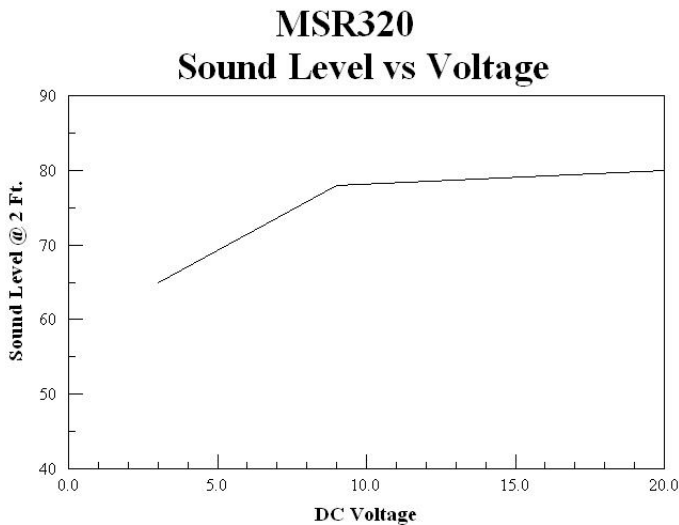

For audible alarm model MSR320R, the sound level will vary from 65 dB at 2 ft. at 3 Vdc up to 80 dB at 2 ft. at 20 Vdc. By varying the voltage from 3 to 20 Vdc, the sound level can be varied by 15 dB. A 10 dB drop in sound level will make the alarm sound half as loud.

There are several ways of electronically controlling the voltage including:

1. Using a manual or digital potentiometer.
2. Using a selector circuit and different values of resistors.
3. Using PWM voltage signals from microcontrollers.

In all cases, care must be taken to make sure that the circuitry and voltage signals used do not interfere with the internal circuitry of the audible alarm. This method of controlling the sound level will probably not work well in the following cases:

1. The sound level of electro-magnetic type alarms do not vary much over the voltage range of these devices, so most electro-magnetic type alarms are not suitable for this method.
2. When you only have a narrow operating voltage range to work with. For example, if you are using the MSR320R at 5 Vdc, the sound level change from 5 Vdc to 3 Vdc is not very much.
3. When the voltage range of the audible alarm is narrow. For example, panel mount model SC307NR only has a voltage range of 3 to 7 Vdc. Over this range, the sound level will vary by only 6 dB. This sound level change is significant, but may not be enough to make a difference in the application.

## External Drive Transducer Circuits

External Drive Transducers require a sine or square wave type signal at the appropriate frequency for the transducer. A sine-wave type signal will produce more sound level than a square-wave type signal. The higher the voltage level (up to the maximum allowed) the higher the sound level will be. Below are two circuits that can be used with external drive transducer devices:

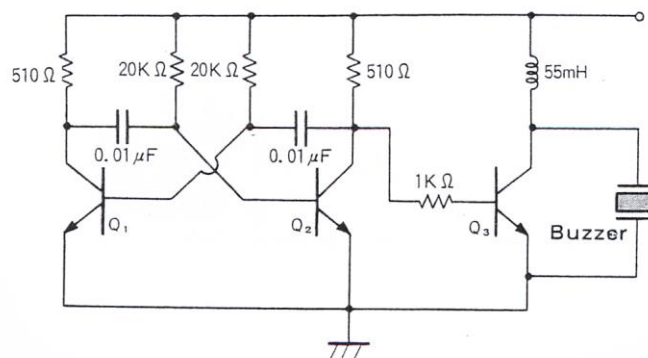
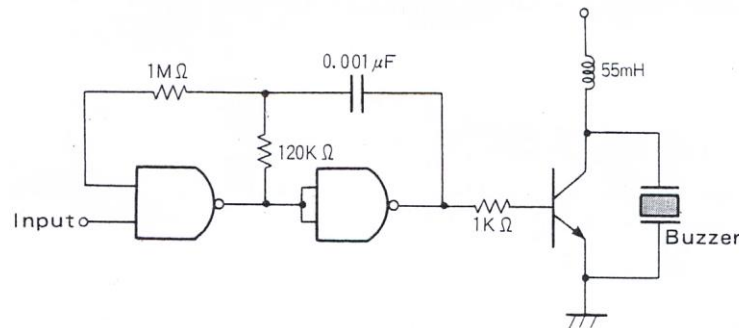

It should be noted that the component values given are starting points only. For example, the inductor shown is optional and the value of the inductor will definitely have to be adjusted depending on the transducer used. Also, the oscillator portion of the transistor circuit will have to be adjusted to match the resonant frequency of the transducer.

## Tube and Tape-n-Reel Counts- All P/N's

Part Number	Tube Count	Reel Count
ASI09N27M-05TRQ	N/A	600
ASI12N35MTRQ	N/A	300
ASI301Q	35	N/A
ASI301TRQ	N/A	250
ASI401Q	35	N/A
ASI401TRQ	N/A	250
AST0540MW-03TRQ	N/A	1000
AST0540MW-3.6TRQ	N/A	1000
AST0727MW-3.6ATRQ	N/A	1000
AST0760MCTRQ	N/A	1000
AST0827MW-03ATRQ	N/A	1000
AST0827MW-03BTRQ	N/A	1000
AST0827MW-03TRQ	N/A	1000
AST0927MW-03TRQ	N/A	1000
AST0927MW-3.6TRQ	N/A	1000
AST0927SFD-03TRQ	N/A	800
AST0940MCTRQ	N/A	1000
AST100Q	25	N/A
AST100TRQ	N/A	500

Part Number	Tube Count	Reel Count
AST1027MW-03TRQ	N/A	800
AST1109MLTRQ	N/A	1000
AST1240MLTRQ	N/A	1000
AST1341MCTRQ	N/A	1000
AST1440MATRQ	N/A	600
AST1575BMATRQ	N/A	300
AST1628MATRQ	N/A	800
AST1640MACTRQ	N/A	800
AST1750MATRQ	N/A	400
AST200Q	48	N/A
AST200TRQ	N/A	1000
AST501Q	35	N/A
AST501TRQ	N/A	450
AST605Q	35	N/A
AST605TRQ	N/A	300
AST612Q	35	N/A
AST612TRQ	N/A	300
AST7525MATRQ	N/A	1000



<b>Part Number</b>	<b>Tube Count</b>	<b>Reel Count</b>
PB-1220PEQ	40	N/A
PB-1220PE-05Q	40	N/A
PB-1220PE-12Q	40	N/A
PB-1220PQ	40	N/A
PB-1220P-05Q	40	N/A
PB-1221PEQ	40	N/A
PB-1221PQ	40	N/A
PB-1224PEQ	40	N/A
PB-1224PE-05Q	40	N/A
PB-1224PE-12Q	40	N/A
PB-12N23P-01Q	40	N/A
PB-12N23P-03Q	40	N/A
PB-12N23P-05Q	40	N/A
PB-12N23P-12Q	40	N/A

**Note:** All other standard part number supplied by Mallory are bulked packed.

## Typical Failure Modes of Piezoelectric Audible Alarms

Component/Subsystem	Failure Mode	End Result	Occurrence
Circuit Components (Resistors, Capacitors, Diodes, IC's, etc.)	Over-voltage by customer's application	Unit ceases working.	Vast Majority of Returns
Transducer/Wire Solder Operation	Not enough wire strands in solder joint	Wire breaks after period of time & unit ceases sounding	Rare
Physical Assembly	Transducer wire pinched, adhesive/epoxy run down onto transducer, or RTV adhesive seal failure	Intermittent operation	Rare
Soldering Operation	Incorrect Solder Temperature or Time Causing Cold Solder Joint	Intermittent operation or unit ceases working after period of time	Very Rare
Circuit Components	Random Component Failure; Wrong Component Used; Missing Component	Unit ceases working under normal operating conditions	Very Rare
Transducer Wire	Defect in Wire; Wire Strands Damaged in Production	Wire breaks after period of time & unit ceases sounding	Very Rare
Piezo Transducer	Incorrect Polarization by Manufacturer; Glue Bonding Failure	Sound volume level decreases over time.	Exceedingly Rare

### Notes:

1. Customer returns of Mallory audible alarms for failure to operate are very rare. Of the few parts returned each year, the vast majority of the root cause of failure is an over-voltage or voltage spike condition caused by the customer's application.
2. All Mallory alarms are, at a minimum, function tested 100% during production, and a final audit is performed. Mallory SC/SBM/SBT/SBS/SNP/LSC/VSB/MSR/MSO/ZA series of alarms are audited 100% at final test by checking that sound level, frequency, and current are within specification limits from 2 to 4 different voltage levels.

Компания «Океан Электроники» предлагает заключение долгосрочных отношений при поставках импортных электронных компонентов на взаимовыгодных условиях!

Наши преимущества:

- Поставка оригинальных импортных электронных компонентов напрямую с производств Америки, Европы и Азии, а так же с крупнейших складов мира;
- Широкая линейка поставок активных и пассивных импортных электронных компонентов (более 30 млн. наименований);
- Поставка сложных, дефицитных, либо снятых с производства позиций;
- Оперативные сроки поставки под заказ (от 5 рабочих дней);
- Экспресс доставка в любую точку России;
- Помощь Конструкторского Отдела и консультации квалифицированных инженеров;
- Техническая поддержка проекта, помощь в подборе аналогов, поставка прототипов;
- Поставка электронных компонентов под контролем ВП;
- Система менеджмента качества сертифицирована по Международному стандарту ISO 9001;
- При необходимости вся продукция военного и аэрокосмического назначения проходит испытания и сертификацию в лаборатории (по согласованию с заказчиком);
- Поставка специализированных компонентов военного и аэрокосмического уровня качества (Xilinx, Altera, Analog Devices, Intersil, Interpoint, Microsemi, Actel, Aeroflex, Peregrine, VPT, Syfer, Eurofarad, Texas Instruments, MS Kennedy, Miteq, Cobham, E2V, MA-COM, Hittite, Mini-Circuits, General Dynamics и др.);

Компания «Океан Электроники» является официальным дистрибьютором и эксклюзивным представителем в России одного из крупнейших производителей разъемов военного и аэрокосмического назначения «JONHON», а так же официальным дистрибьютором и эксклюзивным представителем в России производителя высокотехнологичных и надежных решений для передачи СВЧ сигналов «FORSTAR».



## JONHON

«JONHON» (основан в 1970 г.)

Разъемы специального, военного и аэрокосмического назначения:

(Применяются в военной, авиационной, аэрокосмической, морской, железнодорожной, горно- и нефтедобывающей отраслях промышленности)

«FORSTAR» (основан в 1998 г.)

ВЧ соединители, коаксиальные кабели, кабельные сборки и микроволновые компоненты:

(Применяются в телекоммуникациях гражданского и специального назначения, в средствах связи, РЛС, а так же военной, авиационной и аэрокосмической отраслях промышленности).



Телефон: 8 (812) 309-75-97 (многоканальный)

Факс: 8 (812) 320-03-32

Электронная почта: [ocean@oceanchips.ru](mailto:ocean@oceanchips.ru)

Web: <http://oceanchips.ru/>

Адрес: 198099, г. Санкт-Петербург, ул. Калинина, д. 2, корп. 4, лит. А