

Notice for TAIYO YUDEN products

Please read this notice before using the TAIYO YUDEN products.

⚠️ REMINDERS

■ Product Information in this Catalog

Product information in this catalog is as of October 2019. All of the contents specified herein and production status of the products listed in this catalog are subject to change without notice due to technical improvement of our products, etc. Therefore, please check for the latest information carefully before practical application or use of our products.

Please note that TAIYO YUDEN shall not be in any way responsible for any damages and defects in products or equipment incorporating our products, which are caused under the conditions other than those specified in this catalog or individual product specification sheets.

■ Approval of Product Specifications

Please contact TAIYO YUDEN for further details of product specifications as the individual product specification sheets are available. When using our products, please be sure to approve our product specifications or make a written agreement on the product specification with TAIYO YUDEN in advance.

■ Pre-Evaluation in the Actual Equipment and Conditions

Please conduct validation and verification of our products in actual conditions of mounting and operating environment before using our products.

■ Limited Application

1. Equipment Intended for Use

The products listed in this catalog are intended for general-purpose and standard use in general electronic equipment (e.g., AV equipment, OA equipment, home electric appliances, office equipment, information and communication equipment including, without limitation, mobile phone, and PC) and other equipment specified in this catalog or the individual product specification sheets.

TAIYO YUDEN has the line-up of the products intended for use in automotive electronic equipment, telecommunications infrastructure and industrial equipment, or medical devices classified as GHTF Classes A to C (Japan Classes I to III). Therefore, when using our products for these equipment, please check available applications specified in this catalog or the individual product specification sheets and use the corresponding products.

2. Equipment Requiring Inquiry

Please be sure to contact TAIYO YUDEN for further information before using the products listed in this catalog for the following equipment (excluding intended equipment as specified in this catalog or the individual product specification sheets) which may cause loss of human life, bodily injury, serious property damage and/or serious public impact due to a failure or defect of the products and/or malfunction attributed thereto.

- (1) Transportation equipment (automotive powertrain control system, train control system, and ship control system, etc.)
- (2) Traffic signal equipment
- (3) Disaster prevention equipment, crime prevention equipment
- (4) Medical devices classified as GHTF Class C (Japan Class III)
- (5) Highly public information network equipment, data-processing equipment (telephone exchange, and base station, etc.)
- (6) Any other equipment requiring high levels of quality and/or reliability equal to the equipment listed above

3. Equipment Prohibited for Use

Please do not incorporate our products into the following equipment requiring extremely high levels of safety and/or reliability.

- (1) Aerospace equipment (artificial satellite, rocket, etc.)
- (2) Aviation equipment *¹
- (3) Medical devices classified as GHTF Class D (Japan Class IV), implantable medical devices *²

- (4) Power generation control equipment (nuclear power, hydroelectric power, thermal power plant control system, etc.)
- (5) Undersea equipment (submarine repeating equipment, underwater work equipment, etc.)
- (6) Military equipment
- (7) Any other equipment requiring extremely high levels of safety and/or reliability equal to the equipment listed above

*Notes:

1. There is a possibility that our products can be used only for aviation equipment that does not directly affect the safe operation of aircraft (e.g., in-flight entertainment, cabin light, electric seat, cooking equipment) if such use meets requirements specified separately by TAIYO YUDEN. Please be sure to contact TAIYO YUDEN for further information before using our products for such aviation equipment.
2. Implantable medical devices contain not only internal unit which is implanted in a body, but also external unit which is connected to the internal unit.

4. Limitation of Liability

Please note that unless you obtain prior written consent of TAIYO YUDEN, TAIYO YUDEN shall not be in any way responsible for any damages incurred by you or third parties arising from use of the products listed in this catalog for any equipment that is not intended for use by TAIYO YUDEN, or any equipment requiring inquiry to TAIYO YUDEN or prohibited for use by TAIYO YUDEN as described above.

■ Safety Design

When using our products for high safety and/or reliability-required equipment or circuits, please fully perform safety and/or reliability evaluation. In addition, please install (i) systems equipped with a protection circuit and a protection device and/or (ii) systems equipped with a redundant circuit or other system to prevent an unsafe status in the event of a single fault for a failsafe design to ensure safety.

■ Intellectual Property Rights

Information contained in this catalog is intended to convey examples of typical performances and/or applications of our products and is not intended to make any warranty with respect to the intellectual property rights or any other related rights of TAIYO YUDEN or any third parties nor grant any license under such rights.

■ Limited Warranty

Please note that the scope of warranty for our products is limited to the delivered our products themselves and TAIYO YUDEN shall not be in any way responsible for any damages resulting from a failure or defect in our products. Notwithstanding the foregoing, if there is a written agreement (e.g., supply and purchase agreement, quality assurance agreement) signed by TAIYO YUDEN and your company, TAIYO YUDEN will warrant our products in accordance with such agreement.

■ TAIYO YUDEN's Official Sales Channel

The contents of this catalog are applicable to our products which are purchased from our sales offices or authorized distributors (hereinafter "TAIYO YUDEN's official sales channel"). Please note that the contents of this catalog are not applicable to our products purchased from any seller other than TAIYO YUDEN's official sales channel.

■ Caution for Export

Some of our products listed in this catalog may require specific procedures for export according to "U.S. Export Administration Regulations", "Foreign Exchange and Foreign Trade Control Law" of Japan, and other applicable regulations. Should you have any questions on this matter, please contact our sales staff.

MULTILAYER CERAMIC CAPACITORS

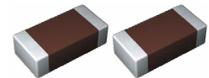

WAVE

REFLOW

PARTS NUMBER

| | | | | | | | | | | | | | | | | |
|---|---|---|---|---|---|---|---|---|---|---|---|---|---|---|---|---|
| J | M | K | 3 | 1 | 6 | △ | B | J | 1 | 0 | 6 | M | L | - | T | △ |
| ① | ② | ③ | ④ | ⑤ | ⑥ | ⑦ | ⑧ | ⑨ | ⑩ | ⑪ | ⑫ | | | | | |

△ = Blank space

① Rated voltage

| Code | Rated voltage [VDC] |
|------|---------------------|
| P | 2.5 |
| A | 4 |
| J | 6.3 |
| L | 10 |
| E | 16 |
| T | 25 |
| G | 35 |
| U | 50 |
| H | 100 |
| Q | 250 |
| S | 630 |
| X | 2000 |

③ End termination

| Code | End termination |
|------|---|
| K | Plated |
| S | Cu Internal Electrodes (For High Frequency) |

② Series name

| Code | Series name |
|------|---|
| M | Multilayer ceramic capacitor |
| V | Multilayer ceramic capacitor for high frequency |
| W | LW reverse type multilayer capacitor |

④ Dimension (L × W)

| Type | Dimensions (L × W) [mm] | EIA (inch) |
|------|-------------------------|------------|
| 021 | 0.25 × 0.125 | 008004 |
| 042 | 0.4 × 0.2 | 01005 |
| 063 | 0.6 × 0.3 | 0201 |
| 105 | 1.0 × 0.5 | 0402 |
| | 0.52 × 1.0 ※ | 0204 |
| 107 | 1.6 × 0.8 | 0603 |
| | 0.8 × 1.6 ※ | 0306 |
| 212 | 2.0 × 1.25 | 0805 |
| | 1.25 × 2.0 ※ | 0508 |
| 316 | 3.2 × 1.6 | 1206 |
| 325 | 3.2 × 2.5 | 1210 |
| 432 | 4.5 × 3.2 | 1812 |

Note : ※LW reverse type (□WK) only

⑤ Dimension tolerance

| Code | Type | L [mm] | W [mm] | T [mm] | |
|------|------------|---------------------|----------------------|----------------------|---------------------|
| △ | ALL | Standard | Standard | Standard | |
| A | 063 | 0.6 ± 0.05 | 0.3 ± 0.05 | 0.3 ± 0.05 | |
| | | 105 | 1.0 ± 0.10 | 0.5 ± 0.10 | 0.5 ± 0.10 |
| | | 107 | 1.6 + 0.15 / - 0.05 | 0.8 + 0.15 / - 0.05 | 0.8 + 0.15 / - 0.05 |
| | 212 | 2.0 + 0.15 / - 0.05 | 1.25 + 0.15 / - 0.05 | 0.45 ± 0.05 | |
| | | | | 0.85 ± 0.10 | |
| | | | | 1.25 + 0.15 / - 0.05 | |
| 316 | 3.2 ± 0.20 | 1.6 ± 0.20 | 0.85 ± 0.10 | | |
| | | | 1.6 ± 0.20 | | |
| | | | 2.5 ± 0.30 | | |
| B | 063 | 0.6 ± 0.09 | 0.3 ± 0.09 | 0.3 ± 0.09 | |
| | | 105 | 1.0 + 0.15 / - 0.05 | 0.5 + 0.15 / - 0.05 | 0.5 + 0.15 / - 0.05 |
| | | 107 | 1.6 + 0.20 / - 0 | 0.8 + 0.20 / - 0 | 0.45 ± 0.05 |
| | 212 | 2.0 + 0.20 / - 0 | 1.25 + 0.20 / - 0 | 0.8 + 0.20 / - 0 | |
| | | | | 0.45 ± 0.05 | |
| | | | | 0.85 ± 0.10 | |
| 316 | 3.2 ± 0.30 | 1.6 ± 0.30 | 1.25 + 0.20 / - 0 | | |
| | | | 1.6 ± 0.30 | | |
| C | 105 | 1.0 + 0.20 / - 0 | 0.5 + 0.20 / - 0 | 0.5 + 0.20 / - 0 | |
| | | | | 0.5 + 0.20 / - 0 | |
| E | 063 | 0.6 + 0.25 / - 0 | 0.3 + 0.25 / - 0 | 0.3 + 0.25 / - 0 | |
| | | 105 | 1.0 + 0.30 / - 0 | 0.5 + 0.30 / - 0 | 0.5 + 0.30 / - 0 |

Note: cf. STANDARD EXTERNAL DIMENSIONS

△ = Blank space

⑥ Temperature characteristics code

■ High dielectric type (Excluding Super low distortion multilayer ceramic capacitor)

| Code | Applicable standard | | Temperature range [°C] | Ref. Temp. [°C] | Capacitance change | Capacitance tolerance | Tolerance code |
|-------|---------------------|-----|------------------------|-----------------|--------------------|-----------------------|----------------|
| BJ | JIS | B | -25 ~ + 85 | 20 | ± 10% | ± 10% | K |
| | | | | | | ± 20% | M |
| | EIA | X5R | -55 ~ + 85 | 25 | ± 15% | ± 10% | K |
| B7 | EIA | X7R | -55 ~ + 125 | 25 | ± 15% | ± 10% | K |
| | | | | | | ± 20% | M |
| C6 | EIA | X6S | -55 ~ + 105 | 25 | ± 22% | ± 10% | K |
| | | | | | | ± 20% | M |
| C7 | EIA | X7S | -55 ~ + 125 | 25 | ± 22% | ± 10% | K |
| | | | | | | ± 20% | M |
| LD(※) | EIA | X5R | -55 ~ + 85 | 25 | ± 15% | ± 10% | K |
| | | | | | | ± 20% | M |

Note : ※LD Low distortion high value multilayer ceramic capacitor

△ = Blank space

▶ This catalog contains the typical specification only due to the limitation of space. When you consider the purchase of our products, please check our product specification sheets. For details of each product (characteristics graph, reliability information, precautions for use, and so on), see our website (<http://www.ty-top.com/>).

■ Temperature compensating type

| Code | Applicable standard | | Temperature range [°C] | Ref. Temp. [°C] | Capacitance change | Capacitance tolerance | Tolerance code |
|------|---------------------|-----|------------------------|-----------------|--------------------|-----------------------|----------------|
| CG | EIA | C0G | -55 ~ +125 | 25 | 0 ± 30ppm/°C | ±0.05pF | A |
| | | | | | | ±0.1pF | B |
| | | | | | | ±0.25pF | C |
| | | | | | | ±0.5pF | D |
| | | | | | | ±5% | J |
| UJ | JIS | UJ | -55 ~ +125 | 20 | -750 ± 120ppm/°C | ±0.25pF | C |
| | | | | | | ±0.5pF | D |
| | EIA | U2J | | 25 | | ±5% | J |
| UK | JIS | UK | -55 ~ +125 | 20 | -750 ± 250ppm/°C | ±0.25pF | C |
| | EIA | U2K | -55 ~ +125 | 25 | | | |

⑥ Series code

• Super low distortion multilayer ceramic capacitor

| Code | Series code |
|------|-------------|
| SD | Standard |

• Medium-High Voltage Multilayer Ceramic Capacitor

| Code | Series code |
|------|-------------|
| SD | Standard |

⑦ Nominal capacitance

| Code (example) | Nominal capacitance |
|----------------|---------------------|
| 0R5 | 0.5pF |
| 010 | 1pF |
| 100 | 10pF |
| 101 | 100pF |
| 102 | 1,000pF |
| 103 | 10,000pF |
| 104 | 0.1 μF |
| 105 | 1.0 μF |
| 106 | 10 μF |
| 107 | 100 μF |

Note : R=Decimal point

⑧ Capacitance tolerance

| Code | Capacitance tolerance |
|------|-----------------------|
| A | ±0.05pF |
| B | ±0.1pF |
| C | ±0.25pF |
| D | ±0.5pF |
| F | ±1pF |
| G | ±2% |
| J | ±5% |
| K | ±10% |
| M | ±20% |
| Z | +80/-20% |

⑨ Thickness

| Code | Thickness [mm] |
|------|------------------------|
| K | 0.125 |
| H | 0.13 |
| E | 0.18 |
| C | 0.2 |
| D | |
| P | 0.3 |
| T | |
| K | 0.45 (107type or more) |
| V | 0.5 |
| W | |
| A | 0.8 |
| D | 0.85 (212type or more) |
| F | 1.15 |
| G | 1.25 |
| L | 1.6 |
| N | 1.9 |
| Y | 2.0 max |
| M | 2.5 |

⑩ Special code

| Code | Special code |
|------|--------------|
| - | Standard |

⑪ Packaging

| Code | Packaging |
|------|---|
| F | φ178mm Taping (2mm pitch) |
| T | φ178mm Taping (4mm pitch) |
| P | φ178mm Taping (4mm pitch, 1000 pcs/reel) 325 type (Thickness code M) |
| R | φ178mm Taping (2mm pitch) 105type only (Thickness code E,H) |
| W | φ178mm Taping (1mm pitch) 021/042type only |

⑫ Internal code

| Code | Internal code |
|------|---------------|
| △ | Standard |

► This catalog contains the typical specification only due to the limitation of space. When you consider the purchase of our products, please check our product specification sheets. For details of each product (characteristics graph, reliability information, precautions for use, and so on), see our website (<http://www.ty-top.com/>).

STANDARD EXTERNAL DIMENSIONS

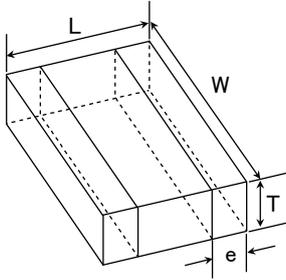
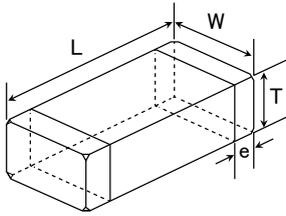

※ LW reverse type

| Type(EIA) | Dimension [mm] | | | | |
|----------------|----------------|-------------|--------------|----|----------------|
| | L | W | T | *1 | e |
| □MK021(008004) | 0.25±0.013 | 0.125±0.013 | 0.125±0.013 | K | 0.0675±0.0275 |
| □VS021(008004) | 0.25±0.013 | 0.125±0.013 | 0.125±0.013 | K | 0.0675±0.0275 |
| □MK042(01005) | 0.4±0.02 | 0.2±0.02 | 0.2±0.02 | C | 0.1±0.03 |
| □VS042(01005) | 0.4±0.02 | 0.2±0.02 | 0.2±0.02 | D | |
| □MK063(0201) | 0.6±0.03 | 0.3±0.03 | 0.3±0.03 | P | 0.15±0.05 |
| | | | | T | |
| □MK105(0402) | 1.0±0.05 | 0.5±0.05 | 0.13±0.02 | H | 0.25±0.10 |
| | | | 0.18±0.02 | E | |
| | | | 0.2±0.02 | C | |
| | | | 0.3±0.03 | P | |
| | | | 0.5±0.05 | V | |
| □VK105(0402) | 1.0±0.05 | 0.5±0.05 | 0.5±0.05 | W | 0.25±0.10 |
| □WK105(0204)※ | 0.52±0.05 | 1.0±0.05 | 0.3±0.05 | P | 0.18±0.08 |
| □MK107(0603) | 1.6±0.10 | 0.8±0.10 | 0.45±0.05 | K | 0.35±0.25 |
| | | | 0.8±0.10 | A | |
| □WK107(0306)※ | 0.8±0.10 | 1.6±0.10 | 0.5±0.05 | V | 0.25±0.15 |
| | | | | | |
| □MK212(0805) | 2.0±0.10 | 1.25±0.10 | 0.45±0.05 | K | 0.5±0.25 |
| | | | 0.85±0.10 | D | |
| | | | 1.25±0.10 | G | |
| □WK212(0508)※ | 1.25±0.15 | 2.0±0.15 | 0.85±0.10 | D | 0.3±0.2 |
| | | | | | |
| □MK316(1206) | 3.2±0.15 | 1.6±0.15 | 0.85±0.10 | D | 0.5+0.35/-0.25 |
| | | | 1.15±0.10 | F | |
| | | | 1.6±0.20 | L | |
| □MK325(1210) | 3.2±0.30 | 2.5±0.20 | 0.85±0.10 | D | 0.6±0.3 |
| | | | 1.15±0.10 | F | |
| | | | 1.9±0.20 | N | |
| | | | 1.9+0.1/-0.2 | Y | |
| | | | 2.5±0.20 | M | |
| □MK432(1812) | 4.5±0.40 | 3.2±0.30 | 2.0+0/-0.30 | Y | 0.6±0.4 |
| | | | 2.5±0.20 | M | 0.9±0.6 |

Note : ※. LW reverse type, *1.Thickness code

STANDARD QUANTITY

| Type | EIA (inch) | Dimension | | Standard quantity [pcs] | | |
|------|------------|-----------|---------|-------------------------|---------------|---|
| | | [mm] | Code | Paper tape | Embossed tape | |
| 021 | 008004 | 0.125 | K | — | 50000 | |
| 042 | 01005 | 0.2 | C | — | 40000 | |
| | | | D | | | |
| 063 | 0201 | 0.3 | P | 15000 | — | |
| | | | T | | | |
| 105 | 0402 | 0.13 | H | — | 20000 | |
| | | | E | | | |
| | | | C | | | |
| | | | P | | | |
| | | | V | | | |
| | | | W | | | |
| | 0204 ※ | 0.30 | P | 10000 | — | |
| 107 | 0603 | 0.45 | K | 4000 | — | |
| | | | A | | | |
| | 0306 ※ | 0.50 | V | — | 4000 | |
| 212 | 0805 | 0.45 | K | 4000 | — | |
| | | | D | | | |
| | | | G | | | |
| | 0508 ※ | 0.85 | D | 4000 | — | |
| 316 | 1206 | 0.85 | D | 4000 | — | |
| | | | F | | | |
| | | | L | | | |
| 325 | 1210 | 0.85 | D | — | 2000 | |
| | | | F | | | |
| | | | N | | | |
| | | | 2.0 max | | | Y |
| | | | 2.5 | | | M |
| 432 | 1812 | 2.0 max | Y | — | 1000 | |
| | | | 2.5 | | | M |

Note : ※.LW Reverse type (□WK)

▶ This catalog contains the typical specification only due to the limitation of space. When you consider the purchase of our products, please check our product specification sheets. For details of each product (characteristics graph, reliability information, precautions for use, and so on), see our website (<http://www.ty-top.com/>).

CERAMIC CAPACITORS
MULTILAYER CERAMIC CAPACITORS

Multilayer Ceramic Capacitors (Temperature compensating type)

● 021TYPE

【Temperature Characteristic CG : CG/C0G (−55~+125°C)】 0.125mm thickness (K)

| Part number 1 | Part number 2 | Rated voltage [V] | Temperature characteristics | Capacitance [F] | Capacitance tolerance | Q (at 1MHz) min | HTLT | Thickness*3 [mm] | Soldering R:Reflow W:Wave |
|------------------|---------------|-------------------|-----------------------------|-----------------|-----------------------|-----------------|-------------------|------------------|---------------------------|
| | | | | | | | Rated voltage x % | | |
| TMK021 CG010□K-W | | 25 | CG C0G | 1 p | ±0.1pF, ±0.25pF | 420 | 200 | 0.125±0.013 | R |
| TMK021 CG1R1□K-W | | | CG C0G | 1.1 p | ±0.1pF, ±0.25pF | 422 | 200 | 0.125±0.013 | R |
| TMK021 CG1R2□K-W | | | CG C0G | 1.2 p | ±0.1pF, ±0.25pF | 424 | 200 | 0.125±0.013 | R |
| TMK021 CG1R3□K-W | | | CG C0G | 1.3 p | ±0.1pF, ±0.25pF | 426 | 200 | 0.125±0.013 | R |
| TMK021 CG1R4□K-W | | | CG C0G | 1.4 p | ±0.1pF, ±0.25pF | 428 | 200 | 0.125±0.013 | R |
| TMK021 CG1R5□K-W | | | CG C0G | 1.5 p | ±0.1pF, ±0.25pF | 430 | 200 | 0.125±0.013 | R |
| TMK021 CG1R6□K-W | | | CG C0G | 1.6 p | ±0.1pF, ±0.25pF | 432 | 200 | 0.125±0.013 | R |
| TMK021 CG1R7□K-W | | | CG C0G | 1.7 p | ±0.1pF, ±0.25pF | 434 | 200 | 0.125±0.013 | R |
| TMK021 CG1R8□K-W | | | CG C0G | 1.8 p | ±0.1pF, ±0.25pF | 436 | 200 | 0.125±0.013 | R |
| TMK021 CG1R9□K-W | | | CG C0G | 1.9 p | ±0.1pF, ±0.25pF | 438 | 200 | 0.125±0.013 | R |
| TMK021 CG020□K-W | | | CG C0G | 2 p | ±0.1pF, ±0.25pF | 440 | 200 | 0.125±0.013 | R |
| TMK021 CG2R1□K-W | | | CG C0G | 2.1 p | ±0.1pF, ±0.25pF | 442 | 200 | 0.125±0.013 | R |
| TMK021 CG2R2□K-W | | | CG C0G | 2.2 p | ±0.1pF, ±0.25pF | 444 | 200 | 0.125±0.013 | R |
| TMK021 CG2R3□K-W | | | CG C0G | 2.3 p | ±0.1pF, ±0.25pF | 446 | 200 | 0.125±0.013 | R |
| TMK021 CG2R4□K-W | | | CG C0G | 2.4 p | ±0.1pF, ±0.25pF | 448 | 200 | 0.125±0.013 | R |
| TMK021 CG2R5□K-W | | | CG C0G | 2.5 p | ±0.1pF, ±0.25pF | 450 | 200 | 0.125±0.013 | R |
| TMK021 CG2R6□K-W | | | CG C0G | 2.6 p | ±0.1pF, ±0.25pF | 452 | 200 | 0.125±0.013 | R |
| TMK021 CG2R7□K-W | | | CG C0G | 2.7 p | ±0.1pF, ±0.25pF | 454 | 200 | 0.125±0.013 | R |
| TMK021 CG2R8□K-W | | | CG C0G | 2.8 p | ±0.1pF, ±0.25pF | 456 | 200 | 0.125±0.013 | R |
| TMK021 CG2R9□K-W | | | CG C0G | 2.9 p | ±0.1pF, ±0.25pF | 458 | 200 | 0.125±0.013 | R |
| TMK021 CG030□K-W | | | CG C0G | 3 p | ±0.1pF, ±0.25pF | 460 | 200 | 0.125±0.013 | R |
| TMK021 CG3R1□K-W | | | CG C0G | 3.1 p | ±0.1pF, ±0.25pF | 462 | 200 | 0.125±0.013 | R |
| TMK021 CG3R2□K-W | | | CG C0G | 3.2 p | ±0.1pF, ±0.25pF | 464 | 200 | 0.125±0.013 | R |
| TMK021 CG3R3□K-W | | | CG C0G | 3.3 p | ±0.1pF, ±0.25pF | 466 | 200 | 0.125±0.013 | R |
| TMK021 CG3R4□K-W | | | CG C0G | 3.4 p | ±0.1pF, ±0.25pF | 468 | 200 | 0.125±0.013 | R |
| TMK021 CG3R5□K-W | | | CG C0G | 3.5 p | ±0.1pF, ±0.25pF | 470 | 200 | 0.125±0.013 | R |
| TMK021 CG3R6□K-W | | | CG C0G | 3.6 p | ±0.1pF, ±0.25pF | 472 | 200 | 0.125±0.013 | R |
| TMK021 CG3R7□K-W | | | CG C0G | 3.7 p | ±0.1pF, ±0.25pF | 474 | 200 | 0.125±0.013 | R |
| TMK021 CG3R8□K-W | | | CG C0G | 3.8 p | ±0.1pF, ±0.25pF | 476 | 200 | 0.125±0.013 | R |
| TMK021 CG3R9□K-W | | | CG C0G | 3.9 p | ±0.1pF, ±0.25pF | 478 | 200 | 0.125±0.013 | R |
| TMK021 CG040□K-W | | | CG C0G | 4 p | ±0.1pF, ±0.25pF | 480 | 200 | 0.125±0.013 | R |
| TMK021 CG4R1□K-W | | | CG C0G | 4.1 p | ±0.1pF, ±0.25pF | 482 | 200 | 0.125±0.013 | R |
| TMK021 CG4R2□K-W | | | CG C0G | 4.2 p | ±0.1pF, ±0.25pF | 484 | 200 | 0.125±0.013 | R |
| TMK021 CG4R3□K-W | | | CG C0G | 4.3 p | ±0.1pF, ±0.25pF | 486 | 200 | 0.125±0.013 | R |
| TMK021 CG4R4□K-W | | | CG C0G | 4.4 p | ±0.1pF, ±0.25pF | 488 | 200 | 0.125±0.013 | R |
| TMK021 CG4R5□K-W | | | CG C0G | 4.5 p | ±0.1pF, ±0.25pF | 490 | 200 | 0.125±0.013 | R |
| TMK021 CG4R6□K-W | | | CG C0G | 4.6 p | ±0.1pF, ±0.25pF | 492 | 200 | 0.125±0.013 | R |
| TMK021 CG4R7□K-W | | | CG C0G | 4.7 p | ±0.1pF, ±0.25pF | 494 | 200 | 0.125±0.013 | R |
| TMK021 CG4R8□K-W | | | CG C0G | 4.8 p | ±0.1pF, ±0.25pF | 496 | 200 | 0.125±0.013 | R |
| TMK021 CG4R9□K-W | | | CG C0G | 4.9 p | ±0.1pF, ±0.25pF | 498 | 200 | 0.125±0.013 | R |
| TMK021 CG050□K-W | | | CG C0G | 5 p | ±0.1pF, ±0.25pF | 500 | 200 | 0.125±0.013 | R |
| TMK021 CG5R1□K-W | | | CG C0G | 5.1 p | ±0.25pF, ±0.5pF | 502 | 200 | 0.125±0.013 | R |
| TMK021 CG5R2□K-W | | | CG C0G | 5.2 p | ±0.25pF, ±0.5pF | 504 | 200 | 0.125±0.013 | R |
| TMK021 CG5R3□K-W | | | CG C0G | 5.3 p | ±0.25pF, ±0.5pF | 506 | 200 | 0.125±0.013 | R |
| TMK021 CG5R4□K-W | | | CG C0G | 5.4 p | ±0.25pF, ±0.5pF | 508 | 200 | 0.125±0.013 | R |
| TMK021 CG5R5□K-W | | | CG C0G | 5.5 p | ±0.25pF, ±0.5pF | 510 | 200 | 0.125±0.013 | R |
| TMK021 CG5R6□K-W | | | CG C0G | 5.6 p | ±0.25pF, ±0.5pF | 512 | 200 | 0.125±0.013 | R |
| TMK021 CG5R7□K-W | | | CG C0G | 5.7 p | ±0.25pF, ±0.5pF | 514 | 200 | 0.125±0.013 | R |
| TMK021 CG5R8□K-W | | | CG C0G | 5.8 p | ±0.25pF, ±0.5pF | 516 | 200 | 0.125±0.013 | R |
| TMK021 CG5R9□K-W | | | CG C0G | 5.9 p | ±0.25pF, ±0.5pF | 518 | 200 | 0.125±0.013 | R |
| TMK021 CG060□K-W | | | CG C0G | 6 p | ±0.25pF, ±0.5pF | 520 | 200 | 0.125±0.013 | R |
| TMK021 CG6R1□K-W | | | CG C0G | 6.1 p | ±0.25pF, ±0.5pF | 522 | 200 | 0.125±0.013 | R |
| TMK021 CG6R2□K-W | | | CG C0G | 6.2 p | ±0.25pF, ±0.5pF | 524 | 200 | 0.125±0.013 | R |
| TMK021 CG6R3□K-W | | | CG C0G | 6.3 p | ±0.25pF, ±0.5pF | 526 | 200 | 0.125±0.013 | R |
| TMK021 CG6R4□K-W | | | CG C0G | 6.4 p | ±0.25pF, ±0.5pF | 528 | 200 | 0.125±0.013 | R |
| TMK021 CG6R5□K-W | | | CG C0G | 6.5 p | ±0.25pF, ±0.5pF | 530 | 200 | 0.125±0.013 | R |
| TMK021 CG6R6□K-W | | | CG C0G | 6.6 p | ±0.25pF, ±0.5pF | 532 | 200 | 0.125±0.013 | R |
| TMK021 CG6R7□K-W | | | CG C0G | 6.7 p | ±0.25pF, ±0.5pF | 534 | 200 | 0.125±0.013 | R |
| TMK021 CG6R8□K-W | | CG C0G | 6.8 p | ±0.25pF, ±0.5pF | 536 | 200 | 0.125±0.013 | R | |
| TMK021 CG6R9□K-W | | CG C0G | 6.9 p | ±0.25pF, ±0.5pF | 538 | 200 | 0.125±0.013 | R | |
| TMK021 CG070□K-W | | CG C0G | 7 p | ±0.25pF, ±0.5pF | 540 | 200 | 0.125±0.013 | R | |
| TMK021 CG7R1□K-W | | CG C0G | 7.1 p | ±0.25pF, ±0.5pF | 542 | 200 | 0.125±0.013 | R | |
| TMK021 CG7R2□K-W | | CG C0G | 7.2 p | ±0.25pF, ±0.5pF | 544 | 200 | 0.125±0.013 | R | |
| TMK021 CG7R3□K-W | | CG C0G | 7.3 p | ±0.25pF, ±0.5pF | 546 | 200 | 0.125±0.013 | R | |
| TMK021 CG7R4□K-W | | CG C0G | 7.4 p | ±0.25pF, ±0.5pF | 548 | 200 | 0.125±0.013 | R | |
| TMK021 CG7R5□K-W | | CG C0G | 7.5 p | ±0.25pF, ±0.5pF | 550 | 200 | 0.125±0.013 | R | |
| TMK021 CG7R6□K-W | | CG C0G | 7.6 p | ±0.25pF, ±0.5pF | 552 | 200 | 0.125±0.013 | R | |
| TMK021 CG7R7□K-W | | CG C0G | 7.7 p | ±0.25pF, ±0.5pF | 554 | 200 | 0.125±0.013 | R | |
| TMK021 CG7R8□K-W | | CG C0G | 7.8 p | ±0.25pF, ±0.5pF | 556 | 200 | 0.125±0.013 | R | |
| TMK021 CG7R9□K-W | | CG C0G | 7.9 p | ±0.25pF, ±0.5pF | 558 | 200 | 0.125±0.013 | R | |
| TMK021 CG080□K-W | | CG C0G | 8 p | ±0.25pF, ±0.5pF | 560 | 200 | 0.125±0.013 | R | |
| TMK021 CG8R1□K-W | | CG C0G | 8.1 p | ±0.25pF, ±0.5pF | 562 | 200 | 0.125±0.013 | R | |
| TMK021 CG8R2□K-W | | CG C0G | 8.2 p | ±0.25pF, ±0.5pF | 564 | 200 | 0.125±0.013 | R | |
| TMK021 CG8R3□K-W | | CG C0G | 8.3 p | ±0.25pF, ±0.5pF | 566 | 200 | 0.125±0.013 | R | |
| TMK021 CG8R4□K-W | | CG C0G | 8.4 p | ±0.25pF, ±0.5pF | 568 | 200 | 0.125±0.013 | R | |
| TMK021 CG8R5□K-W | | CG C0G | 8.5 p | ±0.25pF, ±0.5pF | 570 | 200 | 0.125±0.013 | R | |
| TMK021 CG8R6□K-W | | CG C0G | 8.6 p | ±0.25pF, ±0.5pF | 572 | 200 | 0.125±0.013 | R | |
| TMK021 CG8R7□K-W | | CG C0G | 8.7 p | ±0.25pF, ±0.5pF | 574 | 200 | 0.125±0.013 | R | |
| TMK021 CG8R8□K-W | | CG C0G | 8.8 p | ±0.25pF, ±0.5pF | 576 | 200 | 0.125±0.013 | R | |
| TMK021 CG8R9□K-W | | CG C0G | 8.9 p | ±0.25pF, ±0.5pF | 578 | 200 | 0.125±0.013 | R | |
| TMK021 CG090□K-W | | CG C0G | 9 p | ±0.25pF, ±0.5pF | 580 | 200 | 0.125±0.013 | R | |
| TMK021 CG9R1□K-W | | CG C0G | 9.1 p | ±0.25pF, ±0.5pF | 582 | 200 | 0.125±0.013 | R | |
| TMK021 CG9R2□K-W | | CG C0G | 9.2 p | ±0.25pF, ±0.5pF | 584 | 200 | 0.125±0.013 | R | |
| TMK021 CG9R3□K-W | | CG C0G | 9.3 p | ±0.25pF, ±0.5pF | 586 | 200 | 0.125±0.013 | R | |
| TMK021 CG9R4□K-W | | CG C0G | 9.4 p | ±0.25pF, ±0.5pF | 588 | 200 | 0.125±0.013 | R | |

▶ This catalog contains the typical specification only due to the limitation of space. When you consider the purchase of our products, please check our product specification sheets. For details of each product (characteristics graph, reliability information, precautions for use, and so on), see our website (<http://www.ty-top.com/>).

PARTS NUMBER

| Part number 1 | Part number 2 | Rated voltage [V] | Temperature characteristics | Capacitance [F] | Capacitance tolerance | Q (at 1MHz) min | HTLT | Thickness ^{*3} [mm] | Soldering R:Reflow W:Wave |
|------------------|---------------|-------------------|-----------------------------|-----------------|-----------------------|-----------------|-------------------|------------------------------|---------------------------|
| | | | | | | | Rated voltage x % | | |
| TMK021 CG9R5□K-W | | 25 | CG C0G | 9.5 p | ±0.25pF, ±0.5pF | 590 | 200 | 0.125±0.013 | R |
| TMK021 CG9R6□K-W | | | CG C0G | 9.6 p | ±0.25pF, ±0.5pF | 592 | 200 | 0.125±0.013 | R |
| TMK021 CG9R7□K-W | | | CG C0G | 9.7 p | ±0.25pF, ±0.5pF | 594 | 200 | 0.125±0.013 | R |
| TMK021 CG9R8□K-W | | | CG C0G | 9.8 p | ±0.25pF, ±0.5pF | 596 | 200 | 0.125±0.013 | R |
| TMK021 CG9R9□K-W | | | CG C0G | 9.9 p | ±0.25pF, ±0.5pF | 598 | 200 | 0.125±0.013 | R |
| TMK021 CG100DK-W | | | CG C0G | 10 p | ±0.5pF | 600 | 200 | 0.125±0.013 | R |
| TMK021 CG120JK-W | | | CG C0G | 12 p | ±5% | 640 | 200 | 0.125±0.013 | R |
| TMK021 CG150JK-W | | | CG C0G | 15 p | ±5% | 700 | 200 | 0.125±0.013 | R |
| TMK021 CG180JK-W | | | CG C0G | 18 p | ±5% | 760 | 200 | 0.125±0.013 | R |
| TMK021 CG220JK-W | | | CG C0G | 22 p | ±5% | 840 | 200 | 0.125±0.013 | R |
| TMK021 CG270JK-W | | | CG C0G | 27 p | ±5% | 940 | 200 | 0.125±0.013 | R |
| EMK021 CG330JK-W | | | CG C0G | 33 p | ±5% | 1000 | 150 | 0.125±0.013 | R |
| EMK021 CG390JK-W | | | CG C0G | 39 p | ±5% | 1000 | 150 | 0.125±0.013 | R |
| EMK021 CG470JK-W | | | CG C0G | 47 p | ±5% | 1000 | 150 | 0.125±0.013 | R |
| EMK021 CG560JK-W | | | CG C0G | 56 p | ±5% | 1000 | 150 | 0.125±0.013 | R |
| LMK021 CG680JK-W | | | CG C0G | 68 p | ±5% | 1000 | 200 | 0.125±0.013 | R |
| LMK021 CG820JK-W | | CG C0G | 82 p | ±5% | 1000 | 200 | 0.125±0.013 | R | |
| LMK021 CG101JK-W | | CG C0G | 100 p | ±5% | 1000 | 200 | 0.125±0.013 | R | |

042TYPE

【Temperature Characteristic CG : CG/C0G (-55~+125°C)】 0.2mm thickness (C,D)

| Part number 1 | Part number 2 | Rated voltage [V] | Temperature characteristics | Capacitance [F] | Capacitance tolerance | Q (at 1MHz) min | HTLT | Thickness ^{*3} [mm] | Soldering R:Reflow W:Wave |
|------------------|---------------|-------------------|-----------------------------|-----------------|--------------------------|-----------------|-------------------|------------------------------|---------------------------|
| | | | | | | | Rated voltage x % | | |
| TMK042 CG010□D-W | | 25 | CG C0G | 1 p | ±0.05pF, ±0.1pF, ±0.25pF | 420 | 200 | 0.2±0.02 | R |
| TMK042 CG1R1□D-W | | | CG C0G | 1.1 p | ±0.05pF, ±0.1pF, ±0.25pF | 422 | 200 | 0.2±0.02 | R |
| TMK042 CG1R2□D-W | | | CG C0G | 1.2 p | ±0.05pF, ±0.1pF, ±0.25pF | 424 | 200 | 0.2±0.02 | R |
| TMK042 CG1R3□D-W | | | CG C0G | 1.3 p | ±0.05pF, ±0.1pF, ±0.25pF | 426 | 200 | 0.2±0.02 | R |
| TMK042 CG1R4□D-W | | | CG C0G | 1.4 p | ±0.05pF, ±0.1pF, ±0.25pF | 428 | 200 | 0.2±0.02 | R |
| TMK042 CG1R5□D-W | | | CG C0G | 1.5 p | ±0.05pF, ±0.1pF, ±0.25pF | 430 | 200 | 0.2±0.02 | R |
| TMK042 CG1R6□D-W | | | CG C0G | 1.6 p | ±0.05pF, ±0.1pF, ±0.25pF | 432 | 200 | 0.2±0.02 | R |
| TMK042 CG1R7□D-W | | | CG C0G | 1.7 p | ±0.05pF, ±0.1pF, ±0.25pF | 434 | 200 | 0.2±0.02 | R |
| TMK042 CG1R8□D-W | | | CG C0G | 1.8 p | ±0.05pF, ±0.1pF, ±0.25pF | 436 | 200 | 0.2±0.02 | R |
| TMK042 CG1R9□D-W | | | CG C0G | 1.9 p | ±0.05pF, ±0.1pF, ±0.25pF | 438 | 200 | 0.2±0.02 | R |
| TMK042 CG020□D-W | | | CG C0G | 2 p | ±0.05pF, ±0.1pF, ±0.25pF | 440 | 200 | 0.2±0.02 | R |
| TMK042 CG2R1□D-W | | | CG C0G | 2.1 p | ±0.05pF, ±0.1pF, ±0.25pF | 442 | 200 | 0.2±0.02 | R |
| TMK042 CG2R2□D-W | | | CG C0G | 2.2 p | ±0.05pF, ±0.1pF, ±0.25pF | 444 | 200 | 0.2±0.02 | R |
| TMK042 CG2R3□D-W | | | CG C0G | 2.3 p | ±0.05pF, ±0.1pF, ±0.25pF | 446 | 200 | 0.2±0.02 | R |
| TMK042 CG2R4□D-W | | | CG C0G | 2.4 p | ±0.05pF, ±0.1pF, ±0.25pF | 448 | 200 | 0.2±0.02 | R |
| TMK042 CG2R5□D-W | | | CG C0G | 2.5 p | ±0.05pF, ±0.1pF, ±0.25pF | 450 | 200 | 0.2±0.02 | R |
| TMK042 CG2R6□D-W | | | CG C0G | 2.6 p | ±0.05pF, ±0.1pF, ±0.25pF | 452 | 200 | 0.2±0.02 | R |
| TMK042 CG2R7□D-W | | | CG C0G | 2.7 p | ±0.05pF, ±0.1pF, ±0.25pF | 454 | 200 | 0.2±0.02 | R |
| TMK042 CG2R8□D-W | | | CG C0G | 2.8 p | ±0.05pF, ±0.1pF, ±0.25pF | 456 | 200 | 0.2±0.02 | R |
| TMK042 CG2R9□D-W | | | CG C0G | 2.9 p | ±0.05pF, ±0.1pF, ±0.25pF | 458 | 200 | 0.2±0.02 | R |
| TMK042 CG030□D-W | | | CG C0G | 3 p | ±0.05pF, ±0.1pF, ±0.25pF | 460 | 200 | 0.2±0.02 | R |
| TMK042 CG3R1□D-W | | | CG C0G | 3.1 p | ±0.1pF, ±0.25pF | 462 | 200 | 0.2±0.02 | R |
| TMK042 CG3R2□D-W | | | CG C0G | 3.2 p | ±0.1pF, ±0.25pF | 464 | 200 | 0.2±0.02 | R |
| TMK042 CG3R3□D-W | | | CG C0G | 3.3 p | ±0.1pF, ±0.25pF | 466 | 200 | 0.2±0.02 | R |
| TMK042 CG3R4□D-W | | | CG C0G | 3.4 p | ±0.1pF, ±0.25pF | 468 | 200 | 0.2±0.02 | R |
| TMK042 CG3R5□D-W | | | CG C0G | 3.5 p | ±0.1pF, ±0.25pF | 470 | 200 | 0.2±0.02 | R |
| TMK042 CG3R6□D-W | | | CG C0G | 3.6 p | ±0.1pF, ±0.25pF | 472 | 200 | 0.2±0.02 | R |
| TMK042 CG3R7□D-W | | | CG C0G | 3.7 p | ±0.1pF, ±0.25pF | 474 | 200 | 0.2±0.02 | R |
| TMK042 CG3R8□D-W | | | CG C0G | 3.8 p | ±0.1pF, ±0.25pF | 476 | 200 | 0.2±0.02 | R |
| TMK042 CG3R9□D-W | | | CG C0G | 3.9 p | ±0.1pF, ±0.25pF | 478 | 200 | 0.2±0.02 | R |
| TMK042 CG040□D-W | | | CG C0G | 4 p | ±0.1pF, ±0.25pF | 480 | 200 | 0.2±0.02 | R |
| TMK042 CG4R1□D-W | | | CG C0G | 4.1 p | ±0.1pF, ±0.25pF | 482 | 200 | 0.2±0.02 | R |
| TMK042 CG4R2□D-W | | | CG C0G | 4.2 p | ±0.1pF, ±0.25pF | 484 | 200 | 0.2±0.02 | R |
| TMK042 CG4R3□D-W | | | CG C0G | 4.3 p | ±0.1pF, ±0.25pF | 486 | 200 | 0.2±0.02 | R |
| TMK042 CG4R4□D-W | | | CG C0G | 4.4 p | ±0.1pF, ±0.25pF | 488 | 200 | 0.2±0.02 | R |
| TMK042 CG4R5□D-W | | | CG C0G | 4.5 p | ±0.1pF, ±0.25pF | 490 | 200 | 0.2±0.02 | R |
| TMK042 CG4R6□D-W | | | CG C0G | 4.6 p | ±0.1pF, ±0.25pF | 492 | 200 | 0.2±0.02 | R |
| TMK042 CG4R7□D-W | | | CG C0G | 4.7 p | ±0.1pF, ±0.25pF | 494 | 200 | 0.2±0.02 | R |
| TMK042 CG4R8□D-W | | | CG C0G | 4.8 p | ±0.1pF, ±0.25pF | 496 | 200 | 0.2±0.02 | R |
| TMK042 CG4R9□D-W | | | CG C0G | 4.9 p | ±0.1pF, ±0.25pF | 498 | 200 | 0.2±0.02 | R |
| TMK042 CG050□D-W | | | CG C0G | 5 p | ±0.1pF, ±0.25pF | 500 | 200 | 0.2±0.02 | R |
| TMK042 CG5R1□D-W | | | CG C0G | 5.1 p | ±0.1pF, ±0.25pF, ±0.5pF | 502 | 200 | 0.2±0.02 | R |
| TMK042 CG5R2□D-W | | | CG C0G | 5.2 p | ±0.1pF, ±0.25pF, ±0.5pF | 504 | 200 | 0.2±0.02 | R |
| TMK042 CG5R3□D-W | | | CG C0G | 5.3 p | ±0.1pF, ±0.25pF, ±0.5pF | 506 | 200 | 0.2±0.02 | R |
| TMK042 CG5R4□D-W | | | CG C0G | 5.4 p | ±0.1pF, ±0.25pF, ±0.5pF | 508 | 200 | 0.2±0.02 | R |
| TMK042 CG5R5□D-W | | | CG C0G | 5.5 p | ±0.1pF, ±0.25pF, ±0.5pF | 510 | 200 | 0.2±0.02 | R |
| TMK042 CG5R6□D-W | | | CG C0G | 5.6 p | ±0.1pF, ±0.25pF, ±0.5pF | 512 | 200 | 0.2±0.02 | R |
| TMK042 CG5R7□D-W | | | CG C0G | 5.7 p | ±0.1pF, ±0.25pF, ±0.5pF | 514 | 200 | 0.2±0.02 | R |
| TMK042 CG5R8□D-W | | | CG C0G | 5.8 p | ±0.1pF, ±0.25pF, ±0.5pF | 516 | 200 | 0.2±0.02 | R |
| TMK042 CG5R9□D-W | | | CG C0G | 5.9 p | ±0.1pF, ±0.25pF, ±0.5pF | 518 | 200 | 0.2±0.02 | R |
| TMK042 CG060□D-W | | | CG C0G | 6 p | ±0.1pF, ±0.25pF, ±0.5pF | 520 | 200 | 0.2±0.02 | R |
| TMK042 CG6R1□D-W | | | CG C0G | 6.1 p | ±0.1pF, ±0.25pF, ±0.5pF | 522 | 200 | 0.2±0.02 | R |
| TMK042 CG6R2□D-W | | | CG C0G | 6.2 p | ±0.1pF, ±0.25pF, ±0.5pF | 524 | 200 | 0.2±0.02 | R |
| TMK042 CG6R3□D-W | | | CG C0G | 6.3 p | ±0.1pF, ±0.25pF, ±0.5pF | 526 | 200 | 0.2±0.02 | R |
| TMK042 CG6R4□D-W | | | CG C0G | 6.4 p | ±0.1pF, ±0.25pF, ±0.5pF | 528 | 200 | 0.2±0.02 | R |
| TMK042 CG6R5□D-W | | | CG C0G | 6.5 p | ±0.1pF, ±0.25pF, ±0.5pF | 530 | 200 | 0.2±0.02 | R |
| TMK042 CG6R6□D-W | | | CG C0G | 6.6 p | ±0.1pF, ±0.25pF, ±0.5pF | 532 | 200 | 0.2±0.02 | R |
| TMK042 CG6R7□D-W | | | CG C0G | 6.7 p | ±0.1pF, ±0.25pF, ±0.5pF | 534 | 200 | 0.2±0.02 | R |
| TMK042 CG6R8□D-W | | | CG C0G | 6.8 p | ±0.1pF, ±0.25pF, ±0.5pF | 536 | 200 | 0.2±0.02 | R |
| TMK042 CG6R9□D-W | | | CG C0G | 6.9 p | ±0.1pF, ±0.25pF, ±0.5pF | 538 | 200 | 0.2±0.02 | R |
| TMK042 CG070□D-W | | | CG C0G | 7 p | ±0.1pF, ±0.25pF, ±0.5pF | 540 | 200 | 0.2±0.02 | R |
| TMK042 CG7R1□D-W | | | CG C0G | 7.1 p | ±0.1pF, ±0.25pF, ±0.5pF | 542 | 200 | 0.2±0.02 | R |
| TMK042 CG7R2□D-W | | | CG C0G | 7.2 p | ±0.1pF, ±0.25pF, ±0.5pF | 544 | 200 | 0.2±0.02 | R |
| TMK042 CG7R3□D-W | | | CG C0G | 7.3 p | ±0.1pF, ±0.25pF, ±0.5pF | 546 | 200 | 0.2±0.02 | R |

▶ This catalog contains the typical specification only due to the limitation of space. When you consider the purchase of our products, please check our product specification sheets. For details of each product (characteristics graph, reliability information, precautions for use, and so on), see our website (<http://www.ty-top.com/>).

CERAMIC CAPACITORS MULTILAYER CERAMIC CAPACITORS

PARTS NUMBER

| Part number 1 | Part number 2 | Rated voltage [V] | Temperature characteristics | Capacitance [F] | Capacitance tolerance | Q (at 1MHz) min | HTLT | Thickness*3 [mm] | Soldering R:Reflow W:Wave |
|------------------|---------------|-------------------|-----------------------------|-----------------|-------------------------|-----------------|-------------------|------------------|---------------------------|
| | | | | | | | Rated voltage x % | | |
| TMK042 CG7R4[D-W | | 25 | CG C0G | 7.4 p | ±0.1pF, ±0.25pF, ±0.5pF | 548 | 200 | 0.2±0.02 | R |
| TMK042 CG7R5[D-W | | | CG C0G | 7.5 p | ±0.1pF, ±0.25pF, ±0.5pF | 550 | 200 | 0.2±0.02 | R |
| TMK042 CG7R6[D-W | | | CG C0G | 7.6 p | ±0.1pF, ±0.25pF, ±0.5pF | 552 | 200 | 0.2±0.02 | R |
| TMK042 CG7R7[D-W | | | CG C0G | 7.7 p | ±0.1pF, ±0.25pF, ±0.5pF | 554 | 200 | 0.2±0.02 | R |
| TMK042 CG7R8[D-W | | | CG C0G | 7.8 p | ±0.1pF, ±0.25pF, ±0.5pF | 556 | 200 | 0.2±0.02 | R |
| TMK042 CG7R9[D-W | | | CG C0G | 7.9 p | ±0.1pF, ±0.25pF, ±0.5pF | 558 | 200 | 0.2±0.02 | R |
| TMK042 CG8R0[D-W | | | CG C0G | 8 p | ±0.1pF, ±0.25pF, ±0.5pF | 560 | 200 | 0.2±0.02 | R |
| TMK042 CG8R1[D-W | | | CG C0G | 8.1 p | ±0.1pF, ±0.25pF, ±0.5pF | 562 | 200 | 0.2±0.02 | R |
| TMK042 CG8R2[D-W | | | CG C0G | 8.2 p | ±0.1pF, ±0.25pF, ±0.5pF | 564 | 200 | 0.2±0.02 | R |
| TMK042 CG8R3[D-W | | | CG C0G | 8.3 p | ±0.1pF, ±0.25pF, ±0.5pF | 566 | 200 | 0.2±0.02 | R |
| TMK042 CG8R4[D-W | | | CG C0G | 8.4 p | ±0.1pF, ±0.25pF, ±0.5pF | 568 | 200 | 0.2±0.02 | R |
| TMK042 CG8R5[D-W | | | CG C0G | 8.5 p | ±0.1pF, ±0.25pF, ±0.5pF | 570 | 200 | 0.2±0.02 | R |
| TMK042 CG8R6[D-W | | | CG C0G | 8.6 p | ±0.1pF, ±0.25pF, ±0.5pF | 572 | 200 | 0.2±0.02 | R |
| TMK042 CG8R7[D-W | | | CG C0G | 8.7 p | ±0.1pF, ±0.25pF, ±0.5pF | 574 | 200 | 0.2±0.02 | R |
| TMK042 CG8R8[D-W | | | CG C0G | 8.8 p | ±0.1pF, ±0.25pF, ±0.5pF | 576 | 200 | 0.2±0.02 | R |
| TMK042 CG8R9[D-W | | | CG C0G | 8.9 p | ±0.1pF, ±0.25pF, ±0.5pF | 578 | 200 | 0.2±0.02 | R |
| TMK042 CG9R0[D-W | | | CG C0G | 9 p | ±0.1pF, ±0.25pF, ±0.5pF | 580 | 200 | 0.2±0.02 | R |
| TMK042 CG9R1[D-W | | | CG C0G | 9.1 p | ±0.1pF, ±0.25pF, ±0.5pF | 582 | 200 | 0.2±0.02 | R |
| TMK042 CG9R2[D-W | | | CG C0G | 9.2 p | ±0.1pF, ±0.25pF, ±0.5pF | 584 | 200 | 0.2±0.02 | R |
| TMK042 CG9R3[D-W | | | CG C0G | 9.3 p | ±0.1pF, ±0.25pF, ±0.5pF | 586 | 200 | 0.2±0.02 | R |
| TMK042 CG9R4[D-W | | | CG C0G | 9.4 p | ±0.1pF, ±0.25pF, ±0.5pF | 588 | 200 | 0.2±0.02 | R |
| TMK042 CG9R5[D-W | | | CG C0G | 9.5 p | ±0.1pF, ±0.25pF, ±0.5pF | 590 | 200 | 0.2±0.02 | R |
| TMK042 CG9R6[D-W | | | CG C0G | 9.6 p | ±0.1pF, ±0.25pF, ±0.5pF | 592 | 200 | 0.2±0.02 | R |
| TMK042 CG9R7[D-W | | | CG C0G | 9.7 p | ±0.1pF, ±0.25pF, ±0.5pF | 594 | 200 | 0.2±0.02 | R |
| TMK042 CG9R8[D-W | | | CG C0G | 9.8 p | ±0.1pF, ±0.25pF, ±0.5pF | 596 | 200 | 0.2±0.02 | R |
| TMK042 CG9R9[D-W | | | CG C0G | 9.9 p | ±0.1pF, ±0.25pF, ±0.5pF | 598 | 200 | 0.2±0.02 | R |
| TMK042 CG100DD-W | | | CG C0G | 10 p | ±5% | 600 | 200 | 0.2±0.02 | R |
| TMK042 CG110JD-W | | | CG C0G | 11 p | ±5% | 620 | 200 | 0.2±0.02 | R |
| TMK042 CG120JD-W | | | CG C0G | 12 p | ±5% | 640 | 200 | 0.2±0.02 | R |
| TMK042 CG130JD-W | | | CG C0G | 13 p | ±5% | 660 | 200 | 0.2±0.02 | R |
| TMK042 CG150JD-W | | | CG C0G | 15 p | ±5% | 700 | 200 | 0.2±0.02 | R |
| TMK042 CG160JC-W | | | CG C0G | 16 p | ±5% | 720 | 200 | 0.2±0.02 | R |
| TMK042 CG180JC-W | | | CG C0G | 18 p | ±5% | 760 | 200 | 0.2±0.02 | R |
| TMK042 CG200JC-W | | | CG C0G | 20 p | ±5% | 800 | 200 | 0.2±0.02 | R |
| TMK042 CG220JC-W | | | CG C0G | 22 p | ±5% | 840 | 200 | 0.2±0.02 | R |
| TMK042 CG240JC-W | | | CG C0G | 24 p | ±5% | 880 | 200 | 0.2±0.02 | R |
| TMK042 CG270JC-W | | | CG C0G | 27 p | ±5% | 940 | 200 | 0.2±0.02 | R |
| TMK042 CG300JC-W | | | CG C0G | 30 p | ±5% | 1000 | 200 | 0.2±0.02 | R |
| TMK042 CG330JC-W | | | CG C0G | 33 p | ±5% | 1000 | 200 | 0.2±0.02 | R |
| TMK042 CG360JC-W | | | CG C0G | 36 p | ±5% | 1000 | 200 | 0.2±0.02 | R |
| TMK042 CG390JC-W | | | CG C0G | 39 p | ±5% | 1000 | 200 | 0.2±0.02 | R |
| TMK042 CG430JC-W | | | CG C0G | 43 p | ±5% | 1000 | 200 | 0.2±0.02 | R |
| TMK042 CG470JC-W | | | CG C0G | 47 p | ±5% | 1000 | 200 | 0.2±0.02 | R |
| TMK042 CG510JC-W | | | CG C0G | 51 p | ±5% | 1000 | 200 | 0.2±0.02 | R |
| TMK042 CG560JC-W | | | CG C0G | 56 p | ±5% | 1000 | 200 | 0.2±0.02 | R |
| TMK042 CG620JC-W | | | CG C0G | 62 p | ±5% | 1000 | 200 | 0.2±0.02 | R |
| TMK042 CG680JC-W | | | CG C0G | 68 p | ±5% | 1000 | 200 | 0.2±0.02 | R |
| TMK042 CG750JC-W | | | CG C0G | 75 p | ±5% | 1000 | 200 | 0.2±0.02 | R |
| TMK042 CG820JC-W | | | CG C0G | 82 p | ±5% | 1000 | 200 | 0.2±0.02 | R |
| TMK042 CG910JC-W | | | CG C0G | 91 p | ±5% | 1000 | 200 | 0.2±0.02 | R |
| TMK042 CG101JC-W | | CG C0G | 100 p | ±5% | 1000 | 200 | 0.2±0.02 | R | |

【Temperature Characteristic CG : CG/C0G (-55~+125°C)】 0.2mm thickness (C.D)

| Part number 1 | Part number 2 | Rated voltage [V] | Temperature characteristics | Capacitance [F] | Capacitance tolerance | Q (at 1MHz) min | HTLT | Thickness*3 [mm] | Soldering R:Reflow W:Wave |
|------------------|---------------|-------------------|-----------------------------|-----------------|--------------------------|-----------------|-------------------|------------------|---------------------------|
| | | | | | | | Rated voltage x % | | |
| EMK042 CG010[D-W | | 16 | CG C0G | 1 p | ±0.05pF, ±0.1pF, ±0.25pF | 420 | 200 | 0.2±0.02 | R |
| EMK042 CG1R1[D-W | | | CG C0G | 1.1 p | ±0.05pF, ±0.1pF, ±0.25pF | 422 | 200 | 0.2±0.02 | R |
| EMK042 CG1R2[D-W | | | CG C0G | 1.2 p | ±0.05pF, ±0.1pF, ±0.25pF | 424 | 200 | 0.2±0.02 | R |
| EMK042 CG1R3[D-W | | | CG C0G | 1.3 p | ±0.05pF, ±0.1pF, ±0.25pF | 426 | 200 | 0.2±0.02 | R |
| EMK042 CG1R4[D-W | | | CG C0G | 1.4 p | ±0.05pF, ±0.1pF, ±0.25pF | 428 | 200 | 0.2±0.02 | R |
| EMK042 CG1R5[D-W | | | CG C0G | 1.5 p | ±0.05pF, ±0.1pF, ±0.25pF | 430 | 200 | 0.2±0.02 | R |
| EMK042 CG1R6[D-W | | | CG C0G | 1.6 p | ±0.05pF, ±0.1pF, ±0.25pF | 432 | 200 | 0.2±0.02 | R |
| EMK042 CG1R7[D-W | | | CG C0G | 1.7 p | ±0.05pF, ±0.1pF, ±0.25pF | 434 | 200 | 0.2±0.02 | R |
| EMK042 CG1R8[D-W | | | CG C0G | 1.8 p | ±0.05pF, ±0.1pF, ±0.25pF | 436 | 200 | 0.2±0.02 | R |
| EMK042 CG1R9[D-W | | | CG C0G | 1.9 p | ±0.05pF, ±0.1pF, ±0.25pF | 438 | 200 | 0.2±0.02 | R |
| EMK042 CG020[D-W | | | CG C0G | 2 p | ±0.05pF, ±0.1pF, ±0.25pF | 440 | 200 | 0.2±0.02 | R |
| EMK042 CG2R1[D-W | | | CG C0G | 2.1 p | ±0.05pF, ±0.1pF, ±0.25pF | 442 | 200 | 0.2±0.02 | R |
| EMK042 CG2R2[D-W | | | CG C0G | 2.2 p | ±0.05pF, ±0.1pF, ±0.25pF | 444 | 200 | 0.2±0.02 | R |
| EMK042 CG2R3[D-W | | | CG C0G | 2.3 p | ±0.05pF, ±0.1pF, ±0.25pF | 446 | 200 | 0.2±0.02 | R |
| EMK042 CG2R4[D-W | | | CG C0G | 2.4 p | ±0.05pF, ±0.1pF, ±0.25pF | 448 | 200 | 0.2±0.02 | R |
| EMK042 CG2R5[D-W | | | CG C0G | 2.5 p | ±0.05pF, ±0.1pF, ±0.25pF | 450 | 200 | 0.2±0.02 | R |
| EMK042 CG2R6[D-W | | | CG C0G | 2.6 p | ±0.05pF, ±0.1pF, ±0.25pF | 452 | 200 | 0.2±0.02 | R |
| EMK042 CG2R7[D-W | | | CG C0G | 2.7 p | ±0.05pF, ±0.1pF, ±0.25pF | 454 | 200 | 0.2±0.02 | R |
| EMK042 CG2R8[D-W | | | CG C0G | 2.8 p | ±0.05pF, ±0.1pF, ±0.25pF | 456 | 200 | 0.2±0.02 | R |
| EMK042 CG2R9[D-W | | | CG C0G | 2.9 p | ±0.05pF, ±0.1pF, ±0.25pF | 458 | 200 | 0.2±0.02 | R |
| EMK042 CG030[D-W | | | CG C0G | 3 p | ±0.05pF, ±0.1pF, ±0.25pF | 460 | 200 | 0.2±0.02 | R |
| EMK042 CG3R1[D-W | | | CG C0G | 3.1 p | ±0.1pF, ±0.25pF | 462 | 200 | 0.2±0.02 | R |
| EMK042 CG3R2[D-W | | | CG C0G | 3.2 p | ±0.1pF, ±0.25pF | 464 | 200 | 0.2±0.02 | R |
| EMK042 CG3R3[D-W | | | CG C0G | 3.3 p | ±0.1pF, ±0.25pF | 466 | 200 | 0.2±0.02 | R |
| EMK042 CG3R4[D-W | | | CG C0G | 3.4 p | ±0.1pF, ±0.25pF | 468 | 200 | 0.2±0.02 | R |
| EMK042 CG3R5[D-W | | | CG C0G | 3.5 p | ±0.1pF, ±0.25pF | 470 | 200 | 0.2±0.02 | R |
| EMK042 CG3R6[D-W | | | CG C0G | 3.6 p | ±0.1pF, ±0.25pF | 472 | 200 | 0.2±0.02 | R |
| EMK042 CG3R7[D-W | | | CG C0G | 3.7 p | ±0.1pF, ±0.25pF | 474 | 200 | 0.2±0.02 | R |
| EMK042 CG3R8[D-W | | | CG C0G | 3.8 p | ±0.1pF, ±0.25pF | 476 | 200 | 0.2±0.02 | R |
| EMK042 CG3R9[D-W | | | CG C0G | 3.9 p | ±0.1pF, ±0.25pF | 478 | 200 | 0.2±0.02 | R |
| EMK042 CG040[D-W | | | CG C0G | 4 p | ±0.1pF, ±0.25pF | 480 | 200 | 0.2±0.02 | R |
| EMK042 CG4R1[D-W | | | CG C0G | 4.1 p | ±0.1pF, ±0.25pF | 482 | 200 | 0.2±0.02 | R |
| EMK042 CG4R2[D-W | | | CG C0G | 4.2 p | ±0.1pF, ±0.25pF | 484 | 200 | 0.2±0.02 | R |

▶ This catalog contains the typical specification only due to the limitation of space. When you consider the purchase of our products, please check our product specification sheets. For details of each product (characteristics graph, reliability information, precautions for use, and so on), see our website (<http://www.ty-top.com/>).

■ PARTS NUMBER

CERAMIC CAPACITORS

MULTILAYER CERAMIC CAPACITORS

| Part number 1 | Part number 2 | Rated voltage [V] | Temperature characteristics | | Capacitance [F] | Capacitance tolerance | Q (at 1MHz) min | HTLT | Thickness*3 [mm] | Soldering R:Reflow W:Wave |
|-------------------|---------------|-------------------|-----------------------------|-------|-----------------|-------------------------|-----------------|-------------------|------------------|---------------------------|
| | | | | | | | | Rated voltage x % | | |
| EMK042 CG4R3□D-W | | 16 | CG | C0G | 4.3 p | ±0.1pF, ±0.25pF | 486 | 200 | 0.2±0.02 | R |
| EMK042 CG4R4□D-W | | | CG | C0G | 4.4 p | ±0.1pF, ±0.25pF | 488 | 200 | 0.2±0.02 | R |
| EMK042 CG4R5□D-W | | | CG | C0G | 4.5 p | ±0.1pF, ±0.25pF | 490 | 200 | 0.2±0.02 | R |
| EMK042 CG4R6□D-W | | | CG | C0G | 4.6 p | ±0.1pF, ±0.25pF | 492 | 200 | 0.2±0.02 | R |
| EMK042 CG4R7□D-W | | | CG | C0G | 4.7 p | ±0.1pF, ±0.25pF | 494 | 200 | 0.2±0.02 | R |
| EMK042 CG4R8□D-W | | | CG | C0G | 4.8 p | ±0.1pF, ±0.25pF | 496 | 200 | 0.2±0.02 | R |
| EMK042 CG4R9□D-W | | | CG | C0G | 4.9 p | ±0.1pF, ±0.25pF | 498 | 200 | 0.2±0.02 | R |
| EMK042 CG050□D-W | | | CG | C0G | 5 p | ±0.1pF, ±0.25pF | 500 | 200 | 0.2±0.02 | R |
| EMK042 CG5R1□D-W | | | CG | C0G | 5.1 p | ±0.1pF, ±0.25pF, ±0.5pF | 502 | 200 | 0.2±0.02 | R |
| EMK042 CG5R2□D-W | | | CG | C0G | 5.2 p | ±0.1pF, ±0.25pF, ±0.5pF | 504 | 200 | 0.2±0.02 | R |
| EMK042 CG5R3□D-W | | | CG | C0G | 5.3 p | ±0.1pF, ±0.25pF, ±0.5pF | 506 | 200 | 0.2±0.02 | R |
| EMK042 CG5R4□D-W | | | CG | C0G | 5.4 p | ±0.1pF, ±0.25pF, ±0.5pF | 508 | 200 | 0.2±0.02 | R |
| EMK042 CG5R5□D-W | | | CG | C0G | 5.5 p | ±0.1pF, ±0.25pF, ±0.5pF | 510 | 200 | 0.2±0.02 | R |
| EMK042 CG5R6□D-W | | | CG | C0G | 5.6 p | ±0.1pF, ±0.25pF, ±0.5pF | 512 | 200 | 0.2±0.02 | R |
| EMK042 CG5R7□D-W | | | CG | C0G | 5.7 p | ±0.1pF, ±0.25pF, ±0.5pF | 514 | 200 | 0.2±0.02 | R |
| EMK042 CG5R8□D-W | | | CG | C0G | 5.8 p | ±0.1pF, ±0.25pF, ±0.5pF | 516 | 200 | 0.2±0.02 | R |
| EMK042 CG5R9□D-W | | | CG | C0G | 5.9 p | ±0.1pF, ±0.25pF, ±0.5pF | 518 | 200 | 0.2±0.02 | R |
| EMK042 CG060□D-W | | | CG | C0G | 6 p | ±0.1pF, ±0.25pF, ±0.5pF | 520 | 200 | 0.2±0.02 | R |
| EMK042 CG6R1□D-W | | | CG | C0G | 6.1 p | ±0.1pF, ±0.25pF, ±0.5pF | 522 | 200 | 0.2±0.02 | R |
| EMK042 CG6R2□D-W | | | CG | C0G | 6.2 p | ±0.1pF, ±0.25pF, ±0.5pF | 524 | 200 | 0.2±0.02 | R |
| EMK042 CG6R3□D-W | | | CG | C0G | 6.3 p | ±0.1pF, ±0.25pF, ±0.5pF | 526 | 200 | 0.2±0.02 | R |
| EMK042 CG6R4□D-W | | | CG | C0G | 6.4 p | ±0.1pF, ±0.25pF, ±0.5pF | 528 | 200 | 0.2±0.02 | R |
| EMK042 CG6R5□D-W | | | CG | C0G | 6.5 p | ±0.1pF, ±0.25pF, ±0.5pF | 530 | 200 | 0.2±0.02 | R |
| EMK042 CG6R6□D-W | | | CG | C0G | 6.6 p | ±0.1pF, ±0.25pF, ±0.5pF | 532 | 200 | 0.2±0.02 | R |
| EMK042 CG6R7□D-W | | | CG | C0G | 6.7 p | ±0.1pF, ±0.25pF, ±0.5pF | 534 | 200 | 0.2±0.02 | R |
| EMK042 CG6R8□D-W | | | CG | C0G | 6.8 p | ±0.1pF, ±0.25pF, ±0.5pF | 536 | 200 | 0.2±0.02 | R |
| EMK042 CG6R9□D-W | | | CG | C0G | 6.9 p | ±0.1pF, ±0.25pF, ±0.5pF | 538 | 200 | 0.2±0.02 | R |
| EMK042 CG070□D-W | | | CG | C0G | 7 p | ±0.1pF, ±0.25pF, ±0.5pF | 540 | 200 | 0.2±0.02 | R |
| EMK042 CG7R1□D-W | | | CG | C0G | 7.1 p | ±0.1pF, ±0.25pF, ±0.5pF | 542 | 200 | 0.2±0.02 | R |
| EMK042 CG7R2□D-W | | | CG | C0G | 7.2 p | ±0.1pF, ±0.25pF, ±0.5pF | 544 | 200 | 0.2±0.02 | R |
| EMK042 CG7R3□D-W | | | CG | C0G | 7.3 p | ±0.1pF, ±0.25pF, ±0.5pF | 546 | 200 | 0.2±0.02 | R |
| EMK042 CG7R4□D-W | | | CG | C0G | 7.4 p | ±0.1pF, ±0.25pF, ±0.5pF | 548 | 200 | 0.2±0.02 | R |
| EMK042 CG7R5□D-W | | | CG | C0G | 7.5 p | ±0.1pF, ±0.25pF, ±0.5pF | 550 | 200 | 0.2±0.02 | R |
| EMK042 CG7R6□D-W | | | CG | C0G | 7.6 p | ±0.1pF, ±0.25pF, ±0.5pF | 552 | 200 | 0.2±0.02 | R |
| EMK042 CG7R7□D-W | | | CG | C0G | 7.7 p | ±0.1pF, ±0.25pF, ±0.5pF | 554 | 200 | 0.2±0.02 | R |
| EMK042 CG7R8□D-W | | | CG | C0G | 7.8 p | ±0.1pF, ±0.25pF, ±0.5pF | 556 | 200 | 0.2±0.02 | R |
| EMK042 CG7R9□D-W | | | CG | C0G | 7.9 p | ±0.1pF, ±0.25pF, ±0.5pF | 558 | 200 | 0.2±0.02 | R |
| EMK042 CG080□D-W | | | CG | C0G | 8 p | ±0.1pF, ±0.25pF, ±0.5pF | 560 | 200 | 0.2±0.02 | R |
| EMK042 CG8R1□D-W | | | CG | C0G | 8.1 p | ±0.1pF, ±0.25pF, ±0.5pF | 562 | 200 | 0.2±0.02 | R |
| EMK042 CG8R2□D-W | | | CG | C0G | 8.2 p | ±0.1pF, ±0.25pF, ±0.5pF | 564 | 200 | 0.2±0.02 | R |
| EMK042 CG8R3□D-W | | | CG | C0G | 8.3 p | ±0.1pF, ±0.25pF, ±0.5pF | 566 | 200 | 0.2±0.02 | R |
| EMK042 CG8R4□D-W | | | CG | C0G | 8.4 p | ±0.1pF, ±0.25pF, ±0.5pF | 568 | 200 | 0.2±0.02 | R |
| EMK042 CG8R5□D-W | | | CG | C0G | 8.5 p | ±0.1pF, ±0.25pF, ±0.5pF | 570 | 200 | 0.2±0.02 | R |
| EMK042 CG8R6□D-W | | | CG | C0G | 8.6 p | ±0.1pF, ±0.25pF, ±0.5pF | 572 | 200 | 0.2±0.02 | R |
| EMK042 CG8R7□D-W | | | CG | C0G | 8.7 p | ±0.1pF, ±0.25pF, ±0.5pF | 574 | 200 | 0.2±0.02 | R |
| EMK042 CG8R8□D-W | | | CG | C0G | 8.8 p | ±0.1pF, ±0.25pF, ±0.5pF | 576 | 200 | 0.2±0.02 | R |
| EMK042 CG8R9□D-W | | | CG | C0G | 8.9 p | ±0.1pF, ±0.25pF, ±0.5pF | 578 | 200 | 0.2±0.02 | R |
| EMK042 CG090□D-W | | | CG | C0G | 9 p | ±0.1pF, ±0.25pF, ±0.5pF | 580 | 200 | 0.2±0.02 | R |
| EMK042 CG9R1□D-W | | | CG | C0G | 9.1 p | ±0.1pF, ±0.25pF, ±0.5pF | 582 | 200 | 0.2±0.02 | R |
| EMK042 CG9R2□D-W | | | CG | C0G | 9.2 p | ±0.1pF, ±0.25pF, ±0.5pF | 584 | 200 | 0.2±0.02 | R |
| EMK042 CG9R3□D-W | | | CG | C0G | 9.3 p | ±0.1pF, ±0.25pF, ±0.5pF | 586 | 200 | 0.2±0.02 | R |
| EMK042 CG9R4□D-W | | | CG | C0G | 9.4 p | ±0.1pF, ±0.25pF, ±0.5pF | 588 | 200 | 0.2±0.02 | R |
| EMK042 CG9R5□D-W | | | CG | C0G | 9.5 p | ±0.1pF, ±0.25pF, ±0.5pF | 590 | 200 | 0.2±0.02 | R |
| EMK042 CG9R6□D-W | | | CG | C0G | 9.6 p | ±0.1pF, ±0.25pF, ±0.5pF | 592 | 200 | 0.2±0.02 | R |
| EMK042 CG9R7□D-W | | | CG | C0G | 9.7 p | ±0.1pF, ±0.25pF, ±0.5pF | 594 | 200 | 0.2±0.02 | R |
| EMK042 CG9R8□D-W | | | CG | C0G | 9.8 p | ±0.1pF, ±0.25pF, ±0.5pF | 596 | 200 | 0.2±0.02 | R |
| EMK042 CG9R9□D-W | | | CG | C0G | 9.9 p | ±0.1pF, ±0.25pF, ±0.5pF | 598 | 200 | 0.2±0.02 | R |
| EMK042 CG100DD-W | | | CG | C0G | 10 p | ±0.5pF | 600 | 200 | 0.2±0.02 | R |
| EMK042 CG110JD-W | | | CG | C0G | 11 p | ±5% | 620 | 200 | 0.2±0.02 | R |
| EMK042 CG120JD-W | | | CG | C0G | 12 p | ±5% | 640 | 200 | 0.2±0.02 | R |
| EMK042 CG130JD-W | | CG | C0G | 13 p | ±5% | 660 | 200 | 0.2±0.02 | R | |
| EMK042 CG150JD-W | | CG | C0G | 15 p | ±5% | 700 | 200 | 0.2±0.02 | R | |
| EMK042 CG160JC-W | | CG | C0G | 16 p | ±5% | 720 | 200 | 0.2±0.02 | R | |
| EMK042 CG180JC-W | | CG | C0G | 18 p | ±5% | 760 | 200 | 0.2±0.02 | R | |
| EMK042 CG200JC-W | | CG | C0G | 20 p | ±5% | 800 | 200 | 0.2±0.02 | R | |
| EMK042 CG220JC-W | | CG | C0G | 22 p | ±5% | 840 | 200 | 0.2±0.02 | R | |
| EMK042 CG240JC-W | | CG | C0G | 24 p | ±5% | 880 | 200 | 0.2±0.02 | R | |
| EMK042 CG270JC-W | | CG | C0G | 27 p | ±5% | 940 | 200 | 0.2±0.02 | R | |
| EMK042 CG300JC-W | | CG | C0G | 30 p | ±5% | 1000 | 200 | 0.2±0.02 | R | |
| EMK042 CG330JC-W | | CG | C0G | 33 p | ±5% | 1000 | 200 | 0.2±0.02 | R | |
| EMK042 CG360JC-W | | CG | C0G | 36 p | ±5% | 1000 | 200 | 0.2±0.02 | R | |
| EMK042 CG390JC-W | | CG | C0G | 39 p | ±5% | 1000 | 200 | 0.2±0.02 | R | |
| EMK042 CG430JC-W | | CG | C0G | 43 p | ±5% | 1000 | 200 | 0.2±0.02 | R | |
| EMK042 CG470JC-W | | CG | C0G | 47 p | ±5% | 1000 | 200 | 0.2±0.02 | R | |
| EMK042 CG510JC-W | | CG | C0G | 51 p | ±5% | 1000 | 200 | 0.2±0.02 | R | |
| EMK042 CG560JC-W | | CG | C0G | 56 p | ±5% | 1000 | 200 | 0.2±0.02 | R | |
| EMK042 CG620JC-W | | CG | C0G | 62 p | ±5% | 1000 | 200 | 0.2±0.02 | R | |
| EMK042 CG680JC-W | | CG | C0G | 68 p | ±5% | 1000 | 200 | 0.2±0.02 | R | |
| EMK042 CG750JC-W | | CG | C0G | 75 p | ±5% | 1000 | 200 | 0.2±0.02 | R | |
| EMK042 CG820JC-W | | CG | C0G | 82 p | ±5% | 1000 | 200 | 0.2±0.02 | R | |
| EMK042 CG910JC-W | | CG | C0G | 91 p | ±5% | 1000 | 200 | 0.2±0.02 | R | |
| EMK042 CG1010JC-W | | CG | C0G | 100 p | ±5% | 1000 | 200 | 0.2±0.02 | R | |
| EMK042 CG221JC-W | | CG | C0G | 220 p | ±5% | 1000 | 200 | 0.2±0.02 | R | |
| EMK042 CG241JC-W | | CG | C0G | 240 p | ±5% | 1000 | 200 | 0.2±0.02 | R | |
| EMK042 CG271JC-W | | CG | C0G | 270 p | ±5% | 1000 | 200 | 0.2±0.02 | R | |
| EMK042 CG331JC-W | | CG | C0G | 330 p | ±5% | 1000 | 200 | 0.2±0.02 | R | |

▶ This catalog contains the typical specification only due to the limitation of space. When you consider the purchase of our products, please check our product specification sheets. For details of each product (characteristics graph, reliability information, precautions for use, and so on), see our website (<http://www.ty-top.com/>).

PARTS NUMBER

063TYPE

【Temperature Characteristic CG : CG/C0G (−55~+125°C)】 0.3mm thickness (T)

| Part number 1 | Part number 2 | Rated voltage [V] | Temperature characteristics | | Capacitance [F] | Capacitance tolerance | Q (at 1MHz) min | HTLT | | Thickness*3 [mm] | Soldering R:Reflow W:Wave |
|---------------|---------------|-------------------|-----------------------------|--------|-----------------|-----------------------|-----------------|-------------------|----------|------------------|---------------------------|
| | | | | | | | | Rated voltage x % | | | |
| UMK063 | CG200JT-F | 50 | CG | C0G | 20 p | ±5% | 800 | 200 | | 0.3±0.03 | R |
| UMK063 | CG220JT-F | | CG | C0G | 22 p | ±5% | 840 | 200 | | 0.3±0.03 | R |
| UMK063 | CG240JT-F | | CG | C0G | 24 p | ±5% | 880 | 200 | | 0.3±0.03 | R |
| UMK063 | CG270JT-F | | CG | C0G | 27 p | ±5% | 940 | 200 | | 0.3±0.03 | R |
| UMK063 | CG300JT-F | | CG | C0G | 30 p | ±5% | 1000 | 200 | | 0.3±0.03 | R |
| UMK063 | CG330JT-F | | CG | C0G | 33 p | ±5% | 1000 | 200 | | 0.3±0.03 | R |
| UMK063 | CG360JT-F | | CG | C0G | 36 p | ±5% | 1000 | 200 | | 0.3±0.03 | R |
| UMK063 | CG390JT-F | | CG | C0G | 39 p | ±5% | 1000 | 200 | | 0.3±0.03 | R |
| UMK063 | CG430JT-F | | CG | C0G | 43 p | ±5% | 1000 | 200 | | 0.3±0.03 | R |
| UMK063 | CG470JT-F | | CG | C0G | 47 p | ±5% | 1000 | 200 | | 0.3±0.03 | R |
| UMK063 | CG510JT-F | | CG | C0G | 51 p | ±5% | 1000 | 200 | | 0.3±0.03 | R |
| UMK063 | CG560JT-F | | CG | C0G | 56 p | ±5% | 1000 | 200 | | 0.3±0.03 | R |
| UMK063 | CG620JT-F | | CG | C0G | 62 p | ±5% | 1000 | 200 | | 0.3±0.03 | R |
| UMK063 | CG680JT-F | | CG | C0G | 68 p | ±5% | 1000 | 200 | | 0.3±0.03 | R |
| UMK063 | CG750JT-F | | CG | C0G | 75 p | ±5% | 1000 | 200 | | 0.3±0.03 | R |
| UMK063 | CG820JT-F | | CG | C0G | 82 p | ±5% | 1000 | 200 | | 0.3±0.03 | R |
| UMK063 | CG910JT-F | | CG | C0G | 91 p | ±5% | 1000 | 200 | | 0.3±0.03 | R |
| UMK063 | CG101JT-F | | CG | C0G | 100 p | ±5% | 1000 | 200 | | 0.3±0.03 | R |
| UMK063 | CG111JT-F | | CG | C0G | 110 p | ±5% | 1000 | 200 | | 0.3±0.03 | R |
| UMK063 | CG121JT-F | | CG | C0G | 120 p | ±5% | 1000 | 200 | | 0.3±0.03 | R |
| UMK063 | CG131JT-F | | CG | C0G | 130 p | ±5% | 1000 | 200 | | 0.3±0.03 | R |
| UMK063 | CG151JT-F | | CG | C0G | 150 p | ±5% | 1000 | 200 | | 0.3±0.03 | R |
| UMK063 | CG181JT-F | | CG | C0G | 180 p | ±5% | 1000 | 200 | | 0.3±0.03 | R |
| UMK063 | CG201JT-F | | CG | C0G | 200 p | ±5% | 1000 | 200 | | 0.3±0.03 | R |
| UMK063 | CG221JT-F | | CG | C0G | 220 p | ±5% | 1000 | 200 | | 0.3±0.03 | R |
| TMK063 | CG241JT-F | | CG | C0G | 240 p | ±5% | 1000 | 200 | | 0.3±0.03 | R |
| TMK063 | CG271JT-F | | CG | C0G | 270 p | ±5% | 1000 | 200 | | 0.3±0.03 | R |
| TMK063 | CG301JT-F | | CG | C0G | 300 p | ±5% | 1000 | 200 | | 0.3±0.03 | R |
| TMK063 | CG331JT-F | | CG | C0G | 330 p | ±5% | 1000 | 200 | | 0.3±0.03 | R |
| TMK063 | CG361JT-F | | CG | C0G | 360 p | ±5% | 1000 | 200 | | 0.3±0.03 | R |
| TMK063 | CG391JT-F | | CG | C0G | 390 p | ±5% | 1000 | 200 | | 0.3±0.03 | R |
| TMK063 | CG431JT-F | | CG | C0G | 430 p | ±5% | 1000 | 200 | | 0.3±0.03 | R |
| TMK063 | CG471JT-F | CG | C0G | 470 p | ±5% | 1000 | 200 | | 0.3±0.03 | R | |
| TMK063 | CG511JT-F | CG | C0G | 510 p | ±5% | 1000 | 200 | | 0.3±0.03 | R | |
| TMK063 | CG561JT-F | CG | C0G | 560 p | ±5% | 1000 | 200 | | 0.3±0.03 | R | |
| TMK063 | CG621JT-F | CG | C0G | 620 p | ±5% | 1000 | 200 | | 0.3±0.03 | R | |
| TMK063 | CG681JT-F | CG | C0G | 680 p | ±5% | 1000 | 200 | | 0.3±0.03 | R | |
| TMK063 | CG751JT-F | CG | C0G | 750 p | ±5% | 1000 | 200 | | 0.3±0.03 | R | |
| TMK063 | CG821JT-F | CG | C0G | 820 p | ±5% | 1000 | 200 | | 0.3±0.03 | R | |
| TMK063 | CG911JT-F | CG | C0G | 910 p | ±5% | 1000 | 200 | | 0.3±0.03 | R | |
| TMK063 | CG102JT-F | CG | C0G | 1000 p | ±5% | 1000 | 200 | | 0.3±0.03 | R | |

105TYPE

【Temperature Characteristic UΔ : UΔ/U2Δ (−55~+125°C)】 0.5mm thickness (V)

| Part number 1 | Part number 2 | Rated voltage [V] | Temperature characteristics | | Capacitance [F] | Capacitance tolerance | Q (at 1MHz) min | HTLT | | Thickness*3 [mm] | Soldering R:Reflow W:Wave |
|---------------|---------------|-------------------|-----------------------------|-----|-----------------|-----------------------|-----------------|-------------------|--|------------------|---------------------------|
| | | | | | | | | Rated voltage x % | | | |
| UMK105 | UK0R5CV-F | 50 | UK | U2K | 0.5 p | ±0.25pF | 410 | 200 | | 0.5±0.05 | R |
| UMK105 | UK010CV-F | | UK | U2K | 1 p | ±0.25pF | 420 | 200 | | 0.5±0.05 | R |
| UMK105 | UK1R5CV-F | | UK | U2K | 1.5 p | ±0.25pF | 430 | 200 | | 0.5±0.05 | R |
| UMK105 | UK020CV-F | | UK | U2K | 2 p | ±0.25pF | 440 | 200 | | 0.5±0.05 | R |
| UMK105 | UK030CV-F | | UK | U2K | 3 p | ±0.25pF | 460 | 200 | | 0.5±0.05 | R |
| UMK105 | UJ040CV-F | | UJ | U2J | 4 p | ±0.25pF | 480 | 200 | | 0.5±0.05 | R |
| UMK105 | UJ050CV-F | | UJ | U2J | 5 p | ±0.25pF | 500 | 200 | | 0.5±0.05 | R |
| UMK105 | UJ060DV-F | | UJ | U2J | 6 p | ±0.5pF | 520 | 200 | | 0.5±0.05 | R |
| UMK105 | UJ070DV-F | | UJ | U2J | 7 p | ±0.5pF | 540 | 200 | | 0.5±0.05 | R |
| UMK105 | UJ080DV-F | | UJ | U2J | 8 p | ±0.5pF | 560 | 200 | | 0.5±0.05 | R |
| UMK105 | UJ090DV-F | | UJ | U2J | 9 p | ±0.5pF | 580 | 200 | | 0.5±0.05 | R |
| UMK105 | UJ100DV-F | | UJ | U2J | 10 p | ±0.5pF | 600 | 200 | | 0.5±0.05 | R |
| UMK105 | UJ120JV-F | | UJ | U2J | 12 p | ±5% | 640 | 200 | | 0.5±0.05 | R |
| UMK105 | UJ150JV-F | | UJ | U2J | 15 p | ±5% | 700 | 200 | | 0.5±0.05 | R |
| UMK105 | UJ180JV-F | | UJ | U2J | 18 p | ±5% | 760 | 200 | | 0.5±0.05 | R |
| UMK105 | UJ220JV-F | | UJ | U2J | 22 p | ±5% | 840 | 200 | | 0.5±0.05 | R |
| UMK105 | UJ270JV-F | | UJ | U2J | 27 p | ±5% | 940 | 200 | | 0.5±0.05 | R |
| UMK105 | UJ330JV-F | | UJ | U2J | 33 p | ±5% | 1000 | 200 | | 0.5±0.05 | R |
| UMK105 | UJ390JV-F | | UJ | U2J | 39 p | ±5% | 1000 | 200 | | 0.5±0.05 | R |
| UMK105 | UJ470JV-F | | UJ | U2J | 47 p | ±5% | 1000 | 200 | | 0.5±0.05 | R |
| UMK105 | UJ560JV-F | | UJ | U2J | 56 p | ±5% | 1000 | 200 | | 0.5±0.05 | R |
| UMK105 | UJ680JV-F | | UJ | U2J | 68 p | ±5% | 1000 | 200 | | 0.5±0.05 | R |
| UMK105 | UJ820JV-F | | UJ | U2J | 82 p | ±5% | 1000 | 200 | | 0.5±0.05 | R |
| UMK105 | UJ101JV-F | | UJ | U2J | 100 p | ±5% | 1000 | 200 | | 0.5±0.05 | R |
| UMK105 | UJ121JV-F | | UJ | U2J | 120 p | ±5% | 1000 | 200 | | 0.5±0.05 | R |
| UMK105 | UJ151JV-F | | UJ | U2J | 150 p | ±5% | 1000 | 200 | | 0.5±0.05 | R |
| UMK105 | UJ181JV-F | | UJ | U2J | 180 p | ±5% | 1000 | 200 | | 0.5±0.05 | R |
| UMK105 | UJ221JV-F | | UJ | U2J | 220 p | ±5% | 1000 | 200 | | 0.5±0.05 | R |
| UMK105 | UJ271JV-F | | UJ | U2J | 270 p | ±5% | 1000 | 200 | | 0.5±0.05 | R |
| UMK105 | UJ331JV-F | | UJ | U2J | 330 p | ±5% | 1000 | 200 | | 0.5±0.05 | R |

► This catalog contains the typical specification only due to the limitation of space. When you consider the purchase of our products, please check our product specification sheets. For details of each product (characteristics graph, reliability information, precautions for use, and so on), see our website (<http://www.ty-top.com/>).

Multilayer Ceramic Capacitors

PACKAGING

① Minimum Quantity

● Taped package

| Type(EIA) | Thickness | | Standard quantity [pcs] | |
|--|-----------|------|-------------------------|-----------------|
| | mm | code | Paper tape | Embossed tape |
| <input type="checkbox"/> MK021(008004) | 0.125 | K | — | 50000 |
| <input type="checkbox"/> VS021(008004) | | | | |
| <input type="checkbox"/> MK042(01005) | 0.2 | C, D | — | 40000 |
| <input type="checkbox"/> VS042(01005) | | | | |
| <input type="checkbox"/> MK063(0201) | 0.3 | P, T | 15000 | — |
| <input type="checkbox"/> WK105(0204) ※ | 0.3 | P | 10000 | — |
| <input type="checkbox"/> MK105(0402) <input type="checkbox"/> MF105(0402) | 0.13 | H | — | 20000 |
| | 0.18 | E | — | 15000 |
| | 0.2 | C | 20000 | — |
| | 0.3 | P | 15000 | — |
| | 0.5 | V | 10000 | — |
| <input type="checkbox"/> VK105(0402) | 0.5 | W | 10000 | — |
| <input type="checkbox"/> MK107(0603) | 0.45 | K | 4000 | — |
| <input type="checkbox"/> WK107(0306) ※ | 0.5 | V | — | 4000 |
| <input type="checkbox"/> MF107(0603) | 0.8 | A | 4000 | — |
| <input type="checkbox"/> VS107(0603) | 0.7 | C | 4000 | — |
| <input type="checkbox"/> MJ107(0603) | 0.8 | A | 3000 | 3000 |
| <input type="checkbox"/> MK212(0805) | 0.45 | K | 4000 | — |
| <input type="checkbox"/> WK212(0508) ※ | 0.85 | D | | |
| <input type="checkbox"/> MF212(0805) | 1.25 | G | — | 3000 |
| <input type="checkbox"/> VS212(0805) | 0.85 | D | 4000 | — |
| <input type="checkbox"/> MJ212(0805) | 0.85 | D | 4000 | — |
| | 1.25 | G | — | 2000 |
| <input type="checkbox"/> MK316(1206) <input type="checkbox"/> MF316(1206) | 0.85 | D | 4000 | — |
| | 1.15 | F | — | 3000 |
| | 1.6 | L | — | 2000 |
| <input type="checkbox"/> MJ316(1206) | 1.15 | F | — | 3000 |
| | 1.6 | L | — | 2000 |
| <input type="checkbox"/> MK325(1210) <input type="checkbox"/> MF325(1210) | 0.85 | D | — | 2000 |
| | 1.15 | F | | |
| | 1.9 | N | | |
| | 2.0max. | Y | | |
| <input type="checkbox"/> MJ325(1210) | 2.5 | M | — | 1000 |
| | 1.9 | N | — | 2000 |
| | 2.5 | M | — | 500(T), 1000(P) |
| <input type="checkbox"/> MK432(1812) | 2.5 | M | — | 500 |

Note : ※ LW Reverse type.

② Taping material

※No bottom tape for pressed carrier tape

● Card board carrier tape

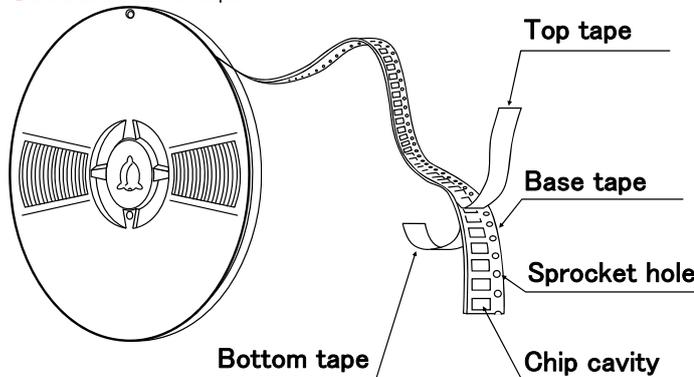

● Embossed tape

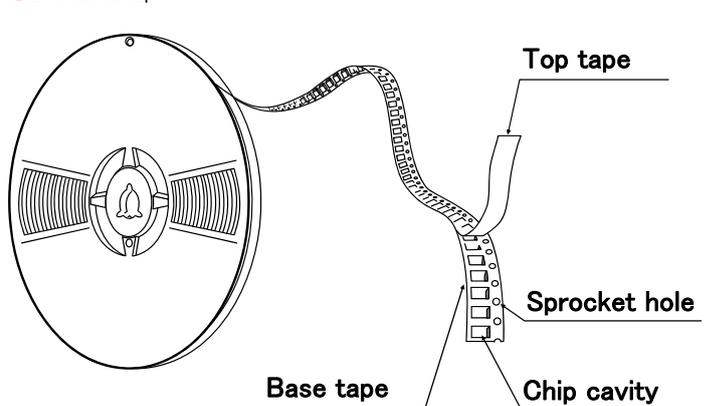

▶ This catalog contains the typical specification only due to the limitation of space. When you consider the purchase of our products, please check our specification. For details of each product (characteristics graph, reliability information, precautions for use, and so on), see our Web site (<http://www.ty-top.com/>).

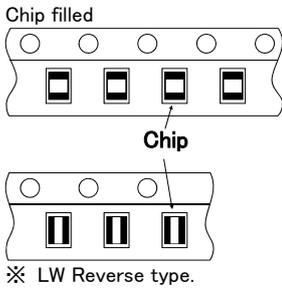

③ Representative taping dimensions

● Paper Tape (8mm wide)

● Pressed carrier tape (2mm pitch)

Unit: mm (inch)

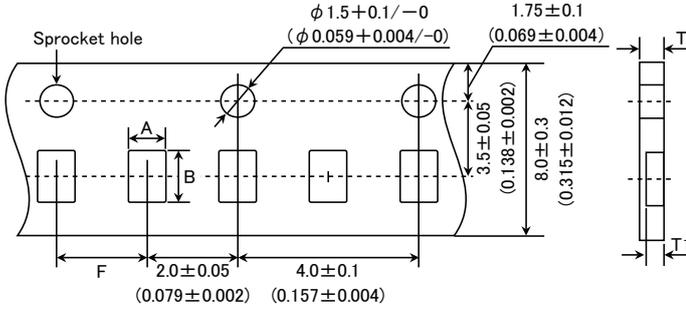

| Type(EIA) | Chip Cavity | | Insertion Pitch F | Tape Thickness | |
|---------------------|-------------|------|----------------------|----------------|----------|
| | A | B | | T | T1 |
| □MK063(0201) | 0.37 | 0.67 | 2.0±0.05 | 0.45max. | 0.42max. |
| □WK105(0204) ※ | 0.65 | 1.15 | | 0.4max. | 0.3max. |
| □MK105(0402) (*1 C) | | | | 0.45max. | 0.42max. |
| □MK105(0402) (*1 P) | | | | | |

Note *1 Thickness, C: 0.2mm ,P: 0.3mm. ※ LW Reverse type.

Unit: mm

● Punched carrier tape (2mm pitch)

Unit: mm (inch)

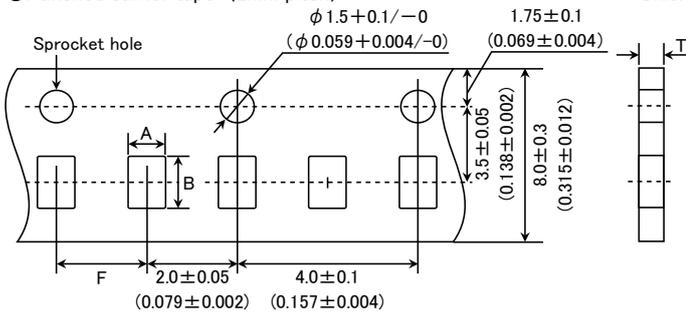

| Type(EIA) | Chip Cavity | | Insertion Pitch F | Tape Thickness |
|---------------|-------------|------|----------------------|----------------|
| | A | B | | T |
| □MK105 (0402) | 0.65 | 1.15 | 2.0±0.05 | 0.8max. |
| □MF105 (0402) | | | | |
| □VK105 (0402) | | | | |

Unit: mm

● Punched carrier tape (4mm pitch)

Unit: mm (inch)

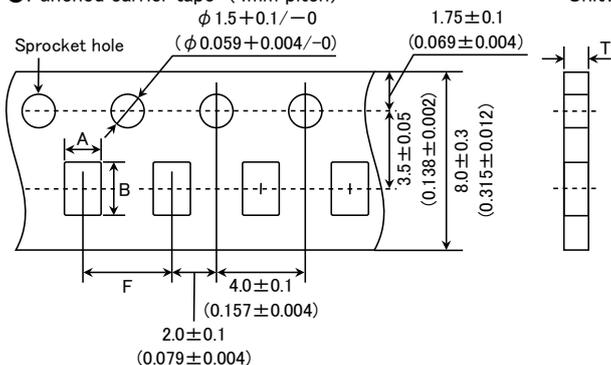

▶ This catalog contains the typical specification only due to the limitation of space. When you consider the purchase of our products, please check our specification. For details of each product (characteristics graph, reliability information, precautions for use, and so on), see our Web site (<http://www.ty-top.com/>).

| Type(EIA) | Chip Cavity | | Insertion Pitch | Tape Thickness |
|--|-------------|-----|-----------------|----------------|
| | A | B | F | T |
| □MK107(0603) □WK107(0306) ※ □MF107(0603) | 1.0 | 1.8 | 4.0±0.1 | 1.1max. |
| □MK212(0805) □WK212(0508) ※ □MK316(1206) | 1.65 | 2.4 | | 1.1max. |
| | 2.0 | 3.6 | | |

Note: Taping size might be different depending on the size of the product. ※ LW Reverse type.

Unit: mm

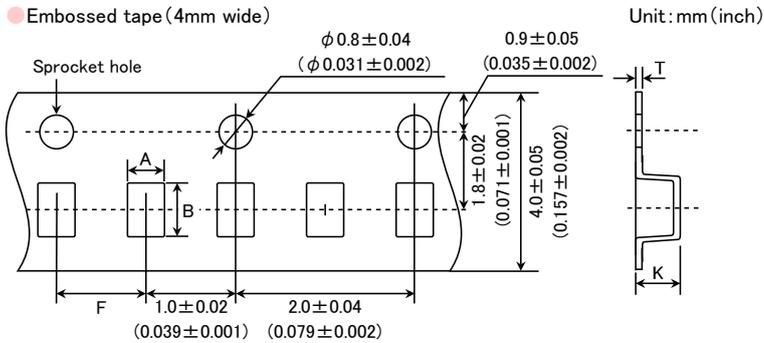

| Type(EIA) | Chip Cavity | | Insertion Pitch | Tape Thickness | |
|--|-------------|------|-----------------|----------------|----------|
| | A | B | F | K | T |
| □MK021(008004) □VS021(008004) □MK042(01005) □VS042(01005) | 0.135 | 0.27 | 1.0±0.02 | 0.5max. | 0.25max. |

Unit: mm

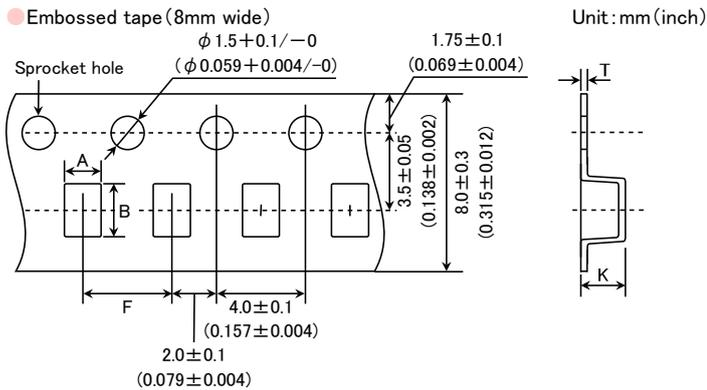

| Type(EIA) | Chip Cavity | | Insertion Pitch | Tape Thickness | |
|--|-------------|-----|-----------------|----------------|----------|
| | A | B | F | K | T |
| □MK105(0402) □WK107(0306) ※ □MK212(0805) □MF212(0805) | 0.6 | 1.1 | 2.0±0.1 | 0.6max. | 0.2±0.1 |
| □MK316(1206) □MF316(1206) | 2.0 | 3.6 | 4.0±0.1 | 1.3max. | 0.25±0.1 |
| □MK325(1210) □MF325(1210) | 2.8 | 3.6 | | | |
| | | | | | |

Note: ※ LW Reverse type.

Unit: mm

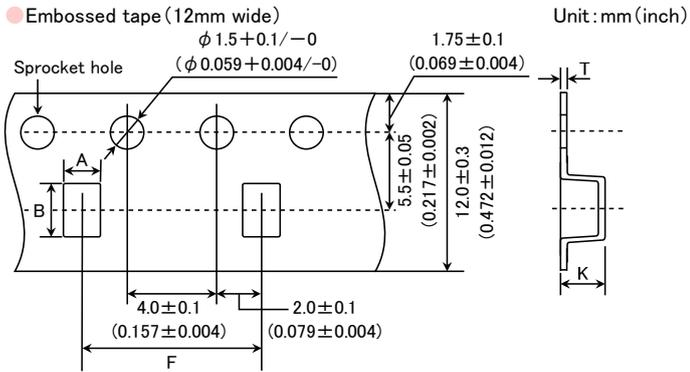

| Type(EIA) | Chip Cavity | | Insertion Pitch | Tape Thickness | |
|--------------|-------------|-----|-----------------|----------------|---------|
| | A | B | F | K | T |
| □MK325(1210) | 3.1 | 4.0 | 8.0±0.1 | 4.0max. | 0.6max. |
| □MK432(1812) | 3.7 | 4.9 | 8.0±0.1 | 4.0max. | 0.6max. |

Unit: mm

④Trailer and Leader

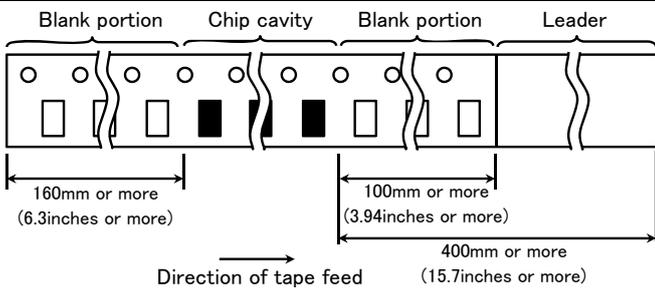

⑤Reel size

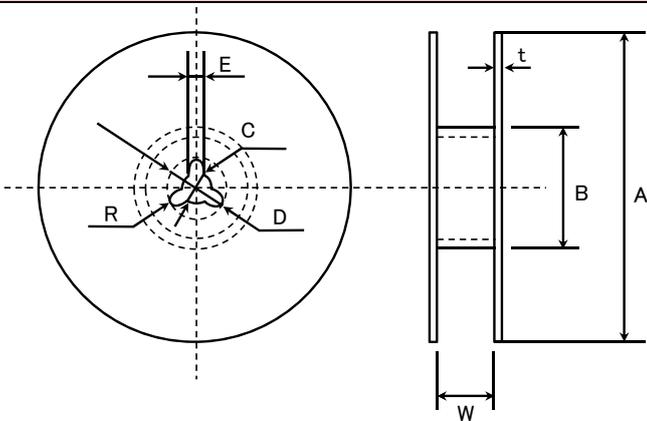

| A | B | C | D | E | R |
|--------------------|------------------------|---------------------|---------------------|---------------|-----|
| $\phi 178 \pm 2.0$ | $\phi 50 \text{ min.}$ | $\phi 13.0 \pm 0.2$ | $\phi 21.0 \pm 0.8$ | 2.0 ± 0.5 | 1.0 |
| | T | W | | | |
| 4mm wide tape | 1.5max. | 5 ± 1.0 | | | |
| 8mm wide tape | 2.5max. | 10 ± 1.5 | | | |
| 12mm wide tape | 2.5max. | 14 ± 1.5 | | | |

Unit: mm

⑥Top Tape Strength

The top tape requires a peel-off force of 0.1 to 0.7N in the direction of the arrow as illustrated below.

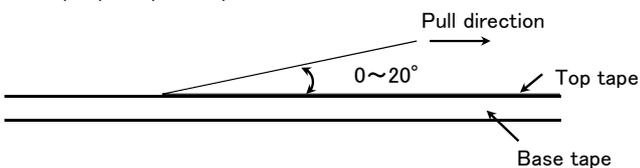

Multilayer Ceramic Capacitors

RELIABILITY DATA

1. Operating Temperature Range

| | | | | |
|-----------------|----------------------------------|---------------------|---------------|-------------------|
| Specified Value | Temperature Compensating(Class1) | Standard | -55 to +125°C | |
| | | High Frequency Type | | |
| Specified Value | High Permittivity (Class2) | | Specification | Temperature Range |
| | | BJ | B | -25 to +85°C |
| | | | X5R | -55 to +85°C |
| | | B7 | X7R | -55 to +125°C |
| | | C6 | X6S | -55 to +105°C |
| | | C7 | X7S | -55 to +125°C |
| | LD(※) | X5R | -55 to +85°C | |

Note: ※LD Low distortion high value multilayer ceramic capacitor

2. Storage Conditions

| | | | | |
|-----------------|----------------------------------|---------------------|---------------|-------------------|
| Specified Value | Temperature Compensating(Class1) | Standard | -55 to +125°C | |
| | | High Frequency Type | | |
| Specified Value | High Permittivity (Class2) | | Specification | Temperature Range |
| | | BJ | B | -25 to +85°C |
| | | | X5R | -55 to +85°C |
| | | B7 | X7R | -55 to +125°C |
| | | C6 | X6S | -55 to +105°C |
| | | C7 | X7S | -55 to +125°C |
| | LD(※) | X5R | -55 to +85°C | |

Note: ※LD Low distortion high value multilayer ceramic capacitor

3. Rated Voltage

| | | | |
|-----------------|----------------------------------|---------------------|---|
| Specified Value | Temperature Compensating(Class1) | Standard | 50VDC, 25VDC, 16VDC |
| | | High Frequency Type | 50VDC, 25VDC, 16VDC |
| | High Permittivity (Class2) | | 50VDC, 35VDC, 25VDC, 16VDC, 10VDC, 6.3VDC, 4VDC, 2.5VDC |

4. Withstanding Voltage (Between terminals)

| | | | |
|--------------------------|----------------------------------|---------------------|------------------------|
| Specified Value | Temperature Compensating(Class1) | Standard | No breakdown or damage |
| | | High Frequency Type | |
| Test Methods and Remarks | High Permittivity (Class2) | | |
| | | Class 1 | Class 2 |
| | Applied voltage | Rated voltage × 3 | Rated voltage × 2.5 |
| | Duration | 1 to 5 sec. | |
| | Charge/discharge current | 50mA max. | |

5. Insulation Resistance

| | | | |
|-----------------|-----------------------------------|---|---|
| Specified Value | Temperature Compensating(Class1) | Standard | 10000 MΩ min. |
| | | High Frequency Type | |
| Specified Value | High Permittivity (Class2) Note 1 | | C ≤ 0.047 F : 10000 MΩ min. C > 0.047 μF : 500MΩ · μF |
| | Test Methods and Remarks | Applied voltage : Rated voltage Duration : 60 ± 5 sec. Charge/discharge current : 50mA max. | |

▶ This catalog contains the typical specification only due to the limitation of space. When you consider the purchase of our products, please check our specification. For details of each product (characteristics graph, reliability information, precautions for use, and so on), see our Web site (<http://www.ty-top.com/>).

6. Capacitance (Tolerance)

| | | | | |
|----------------------------|----------------------------------|---------------------|----|---|
| Specified Value | Temperature Compensating(Class1) | Standard | C□ | 0.2pF ≤ C ≤ 5pF : ±0.25pF |
| | | | U□ | 0.2pF ≤ C ≤ 10pF : ±0.5pF C > 10pF : ±5% or ±10% |
| High Permittivity (Class2) | | High Frequency Type | CG | 0.2pF ≤ C ≤ 2pF : ±0.1pF C > 2pF : ±5% |
| | | | | ±10% or ±20% |

| | | | | | |
|--------------------------|-----------------------|--------------|---------------------|---|---------------|
| Test Methods and Remarks | | Class 1 | | Class 2 | |
| | | Standard | High Frequency Type | C ≤ 10 μF | C > 10 μF |
| | Preconditioning | None | | Thermal treatment (at 150°C for 1hr) Note 2 | |
| | Measuring frequency | 1MHz ± 10% | | 1kHz ± 10% | 120 ± 10Hz |
| | Measuring voltage Nte | 0.5 to 5Vrms | | 1 ± 0.2Vrms | 0.5 ± 0.1Vrms |
| Bias application | None | | | | |

7. Q or Dissipation Factor

| | | | |
|-----------------------------------|----------------------------------|---------------------------|--|
| Specified Value | Temperature Compensating(Class1) | Standard | C < 30pF : Q ≥ 400 + 20C C ≥ 30pF : Q ≥ 1000 (C: Nominal capacitance) |
| | | | High Frequency Type |
| High Permittivity (Class2) Note 1 | | BJ, B7, C6, C7: 2.5% max. | |

| | | | | | |
|--|--------------------------|--------------|---------------------|---|---------------|
| Test Methods and Remarks | | Class 1 | | Class 2 | |
| | | Standard | High Frequency Type | C ≤ 10 μF | C > 10 μF |
| | Preconditioning | None | | Thermal treatment (at 150°C for 1hr) Note 2 | |
| | Measuring frequency | 1MHz ± 10% | 1GHz | 1kHz ± 10% | 120 ± 10Hz |
| | Measuring voltage Note 1 | 0.5 to 5Vrms | | 1 ± 0.2Vrms | 0.5 ± 0.1Vrms |
| Bias application | None | | | | |
| High Frequency Type Measuring equipment : HP4291A Measuring jig : HP16192A | | | | | |

8. Temperature Characteristic (Without voltage application)

| | | | | | | | | | | | | | | | | | | | |
|--|---|---|-------------------------------------|---------------|----------------------|-----------------------|-------------------|------|---|--------------------|---|-------------------------------|--|---|------|------|---|-------------------------------|--|
| Specified Value | Temperature Compensating(Class1) | Standard | Temperature Characteristic [ppm/°C] | | Tolerance [ppm/°C] | | | | | | | | | | | | | | |
| | | | C□ : 0 | CG | G : ±30 | | | | | | | | | | | | | | |
| High Permittivity (Class2) | | High Frequency Type | U□ : -750 | UJ, UK | J : ±120 K : ±250 | | | | | | | | | | | | | | |
| | | | Temperature Characteristic [ppm/°C] | | Tolerance [ppm/°C] | | | | | | | | | | | | | | |
| | | | C□ : 0 | CG | G : ±30 | | | | | | | | | | | | | | |
| Test Methods and Remarks | Class 1 Capacitance at 20°C and 85°C shall be measured in thermal equilibrium, and the temperature characteristic shall be calculated from the following equation. $\frac{(C_{85} - C_{20})}{C_{20} \times \Delta T} \times 10^6 (\text{ppm}/^\circ\text{C}) \quad \Delta T = 65$ | Class 2 Capacitance at each step shall be measured in thermal equilibrium, and the temperature characteristic shall be calculated from the following equation. | | Specification | Capacitance change | Reference temperature | Temperature Range | | | | | | | | | | | | |
| | | | BJ | B | ±10% | 20°C | -25 to +85°C | | | | | | | | | | | | |
| | | | | X5R | ±15% | 25°C | -55 to +85°C | | | | | | | | | | | | |
| | | | B7 | X7R | ±15% | 25°C | -55 to +125°C | | | | | | | | | | | | |
| | | | | X5R | ±22% | 25°C | -55 to +105°C | | | | | | | | | | | | |
| | | | | X7S | ±22% | 25°C | -55 to +125°C | | | | | | | | | | | | |
| | | | LD(※) | X5R | ±15% | 25°C | -55 to +85°C | | | | | | | | | | | | |
| Note : ※LD Low distortion high value multilayer ceramic capacitor | | | | | | | | | | | | | | | | | | | |
| <table border="1"> <tr> <td>Step</td> <td>B</td> <td>X5R, X7R, X6S, X7S</td> </tr> <tr> <td>1</td> <td colspan="2">Minimum operating temperature</td> </tr> <tr> <td>2</td> <td>20°C</td> <td>25°C</td> </tr> <tr> <td>3</td> <td colspan="2">Maximum operating temperature</td> </tr> </table> $\frac{(C - C_2)}{C_2} \times 100 (\%)$ <p>C : Capacitance in Step 1 or Step 3 C₂ : Capacitance in Step 2</p> | | | | | | | | Step | B | X5R, X7R, X6S, X7S | 1 | Minimum operating temperature | | 2 | 20°C | 25°C | 3 | Maximum operating temperature | |
| Step | B | X5R, X7R, X6S, X7S | | | | | | | | | | | | | | | | | |
| 1 | Minimum operating temperature | | | | | | | | | | | | | | | | | | |
| 2 | 20°C | 25°C | | | | | | | | | | | | | | | | | |
| 3 | Maximum operating temperature | | | | | | | | | | | | | | | | | | |

▶ This catalog contains the typical specification only due to the limitation of space. When you consider the purchase of our products, please check our specification. For details of each product (characteristics graph, reliability information, precautions for use, and so on), see our Web site (<http://www.ty-top.com/>).

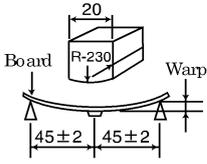
| 9. Deflection | | | | | | | | | | | | | | | | | | | | |
|--------------------------|--|-------------------------------|--|-------------------------------|--|--------------------------|-----------------|-------|-----------------------------|--|-----------|-------|-------|------|-----|--|----------|---------|--|--|
| Specified Value | Temperature Compensating(Class1) | Standard | Appearance : No abnormality Capacitance change : Within $\pm 5\%$ or ± 0.5 pF, whichever is larger. | | | | | | | | | | | | | | | | | |
| | | High Frequency Type | Appearance : No abnormality Capacitance change : Within ± 0.5 pF | | | | | | | | | | | | | | | | | |
| | High Permittivity (Class2) | | Appearance : No abnormality Capacitance change : Within $\pm 12.5\%$ | | | | | | | | | | | | | | | | | |
| Test Methods and Remarks | <table border="1"> <thead> <tr> <th rowspan="2"></th> <th colspan="2">Multilayer Ceramic Capacitors</th> </tr> <tr> <th>021, 042, 063, *105 Type</th> <th>The other types</th> </tr> </thead> <tbody> <tr> <td>Board</td> <td colspan="2">Glass epoxy-resin substrate</td> </tr> <tr> <td>Thickness</td> <td>0.8mm</td> <td>1.6mm</td> </tr> <tr> <td>Warp</td> <td colspan="2">1mm</td> </tr> <tr> <td>Duration</td> <td colspan="2">10 sec.</td> </tr> </tbody> </table> <p>*105 Type thickness, C: 0.2mm ,P: 0.3mm.</p> | | | Multilayer Ceramic Capacitors | | 021, 042, 063, *105 Type | The other types | Board | Glass epoxy-resin substrate | | Thickness | 0.8mm | 1.6mm | Warp | 1mm | | Duration | 10 sec. | |  <p>(Unit: mm) Capacitance measurement shall be conducted with the board bent</p> |
| | | Multilayer Ceramic Capacitors | | | | | | | | | | | | | | | | | | |
| 021, 042, 063, *105 Type | | The other types | | | | | | | | | | | | | | | | | | |
| Board | Glass epoxy-resin substrate | | | | | | | | | | | | | | | | | | | |
| Thickness | 0.8mm | 1.6mm | | | | | | | | | | | | | | | | | | |
| Warp | 1mm | | | | | | | | | | | | | | | | | | | |
| Duration | 10 sec. | | | | | | | | | | | | | | | | | | | |
| | | | | | | | | | | | | | | | | | | | | |

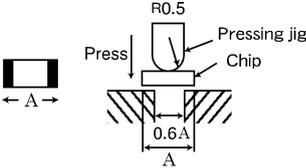
| 10. Body Strength | | | |
|--------------------------|--|---------------------|---|
| Specified Value | Temperature Compensating(Class1) | Standard | — |
| | | High Frequency Type | No mechanical damage. |
| | High Permittivity (Class2) | | — |
| Test Methods and Remarks | High Frequency 105Type Applied force : 5N Duration : 10 sec. | |  |
| | | | |

| 11. Adhesive Strength of Terminal Electrodes | | | | | | | | | | | | | | |
|--|--|-------------------------------|---|-------------------------------|--|--------------------|------------------|---------------|----|----|----------|-----------|--|--|
| Specified Value | Temperature Compensating(Class1) | Standard | No terminal separation or its indication. | | | | | | | | | | | |
| | | High Frequency Type | | | | | | | | | | | | |
| | High Permittivity (Class2) | | | | | | | | | | | | | |
| Test Methods and Remarks | <table border="1"> <thead> <tr> <th rowspan="2"></th> <th colspan="2">Multilayer Ceramic Capacitors</th> </tr> <tr> <th>021, 042, 063 Type</th> <th>105 Type or more</th> </tr> </thead> <tbody> <tr> <td>Applied force</td> <td>2N</td> <td>5N</td> </tr> <tr> <td>Duration</td> <td colspan="2">30±5 sec.</td> </tr> </tbody> </table> | | | Multilayer Ceramic Capacitors | | 021, 042, 063 Type | 105 Type or more | Applied force | 2N | 5N | Duration | 30±5 sec. | | |
| | | Multilayer Ceramic Capacitors | | | | | | | | | | | | |
| | | 021, 042, 063 Type | 105 Type or more | | | | | | | | | | | |
| | Applied force | 2N | 5N | | | | | | | | | | | |
| Duration | 30±5 sec. | | | | | | | | | | | | | |
| | | | | | | | | | | | | | | |
| | | | | | | | | | | | | | | |

| 12. Solderability | | | | | | | | | | | | | | | |
|--------------------------|---|---------------------|--|------------------|------------------|-------------|--------------|----------------|--------------------|---------|---------|----------|----------|--|--|
| Specified Value | Temperature Compensating(Class1) | Standard | At least 95% of terminal electrode is covered by new solder. | | | | | | | | | | | | |
| | | High Frequency Type | | | | | | | | | | | | | |
| | High Permittivity (Class2) | | | | | | | | | | | | | | |
| Test Methods and Remarks | <table border="1"> <thead> <tr> <th rowspan="2"></th> <th>Eutectic solder</th> <th>Lead-free solder</th> </tr> </thead> <tbody> <tr> <td>Solder type</td> <td>H60A or H63A</td> <td>Sn-3.0Ag-0.5Cu</td> </tr> <tr> <td>Solder temperature</td> <td>230±5°C</td> <td>245±3°C</td> </tr> <tr> <td>Duration</td> <td colspan="2">4±1 sec.</td> </tr> </tbody> </table> | | | Eutectic solder | Lead-free solder | Solder type | H60A or H63A | Sn-3.0Ag-0.5Cu | Solder temperature | 230±5°C | 245±3°C | Duration | 4±1 sec. | | |
| | | Eutectic solder | | Lead-free solder | | | | | | | | | | | |
| | | Solder type | H60A or H63A | Sn-3.0Ag-0.5Cu | | | | | | | | | | | |
| | Solder temperature | 230±5°C | 245±3°C | | | | | | | | | | | | |
| Duration | 4±1 sec. | | | | | | | | | | | | | | |
| | | | | | | | | | | | | | | | |
| | | | | | | | | | | | | | | | |

▶ This catalog contains the typical specification only due to the limitation of space. When you consider the purchase of our products, please check our specification. For details of each product (characteristics graph, reliability information, precautions for use, and so on), see our Web site (<http://www.ty-top.com/>).

13. Resistance to Soldering

| | | | |
|-----------------|-----------------------------------|---------------------|---|
| Specified Value | Temperature Compensating(Class1) | Standard | Appearance : No abnormality Capacitance change : Within $\pm 2.5\%$ or $\pm 0.25\text{pF}$, whichever is larger. Q : Initial value Insulation resistance : Initial value Withstanding voltage (between terminals) : No abnormality |
| | | High Frequency Type | Appearance : No abnormality Capacitance change : Within $\pm 2.5\%$ Q : Initial value Insulation resistance : Initial value Withstanding voltage (between terminals) : No abnormality |
| | High Permittivity (Class2) Note 1 | | Appearance : No abnormality Capacitance change : Within $\pm 7.5\%$ Dissipation factor : Initial value Insulation resistance : Initial value Withstanding voltage (between terminals): No abnormality |

| | | | | |
|--------------------------|-----------------|--|---|---|
| Test Methods and Remarks | Class 1 | | | |
| | | 021, 042, 063 Type | 105 Type | |
| | Preconditioning | None | | |
| | Preheating | 150°C, 1 to 2 min. | 80 to 100°C, 2 to 5 min. 150 to 200°C, 2 to 5 min. | |
| | Solder temp. | 270 \pm 5°C | | |
| | Duration | 3 \pm 0.5 sec. | | |
| | Recovery | 6 to 24 hrs (Standard condition) Note 5 | | |
| | Class 2 | | | |
| | | 021, 042, 063 Type | 105, 107, 212 Type | 316, 325, 432 Type |
| | Preconditioning | Thermal treatment (at 150°C for 1 hr) Note 2 | | |
| | Preheating | 150°C, 1 to 2 min. | 80 to 100°C, 2 to 5 min. 150 to 200°C, 2 to 5 min. | 80 to 100°C, 5 to 10 min. 150 to 200°C, 5 to 10 min. |
| | Solder temp. | 270 \pm 5°C | | |
| | Duration | 3 \pm 0.5 sec. | | |
| | Recovery | 24 \pm 2 hrs (Standard condition) Note 5 | | |

14. Temperature Cycle (Thermal Shock)

| | | | |
|-----------------|-----------------------------------|---------------------|---|
| Specified Value | Temperature Compensating(Class1) | Standard | Appearance : No abnormality Capacitance change : Within $\pm 2.5\%$ or $\pm 0.25\text{pF}$, whichever is larger. Q : Initial value Insulation resistance : Initial value Withstanding voltage (between terminals) : No abnormality |
| | | High Frequency Type | Appearance : No abnormality Capacitance change : Within $\pm 0.25\text{pF}$ Q : Initial value Insulation resistance : Initial value Withstanding voltage (between terminals) : No abnormality |
| | High Permittivity (Class2) Note 1 | | Appearance : No abnormality Capacitance change : Within $\pm 7.5\%$ Dissipation factor : Initial value Insulation resistance : Initial value Withstanding voltage (between terminals) : No abnormality |

| | | | | | |
|--------------------------|---|-------------------------------|--|--|--|
| Test Methods and Remarks | Class 1 | | Class 2 | | |
| | Preconditioning | None | | Thermal treatment (at 150°C for 1 hr) Note 2 | |
| | 1 cycle | Step | Temperature (°C) | Time (min.) | |
| | | 1 | Minimum operating temperature | 30 \pm 3 | |
| | | 2 | Normal temperature | 2 to 3 | |
| 3 | | Maximum operating temperature | 30 \pm 3 | | |
| 4 | Normal temperature | 2 to 3 | | | |
| Number of cycles | 5 times | | | | |
| Recovery | 6 to 24 hrs (Standard condition) Note 5 | | 24 \pm 2 hrs (Standard condition) Note 5 | | |

▶ This catalog contains the typical specification only due to the limitation of space. When you consider the purchase of our products, please check our specification. For details of each product (characteristics graph, reliability information, precautions for use, and so on), see our Web site (<http://www.ty-top.com/>).

15. Humidity (Steady State)

| | | | |
|-----------------|-----------------------------------|---------------------|---|
| Specified Value | Temperature Compensating(Class1) | Standard | Appearance : No abnormality Capacitance change : Within $\pm 5\%$ or $\pm 0.5\text{pF}$, whichever is larger. Q : $C < 10\text{pF} : Q \geq 200 + 10C$ $10 \leq C < 30\text{pF} : Q \geq 275 + 2.5C$ $C \geq 30\text{pF} : Q \geq 350 (C : \text{Nominal capacitance})$ Insulation resistance : $1000 \text{ M}\Omega$ min. |
| | | High Frequency Type | Appearance : No abnormality Capacitance change : Within $\pm 0.5\text{pF}$, Insulation resistance : $1000 \text{ M}\Omega$ min. |
| | High Permittivity (Class2) Note 1 | | Appearance : No abnormality Capacitance change : Within $\pm 12.5\%$ Dissipation factor : 5.0% max. Insulation resistance : $50 \text{ M}\Omega \mu\text{F}$ or $1000 \text{ M}\Omega$ whichever is smaller. |

| | | | | |
|--------------------------|-----------------|---|--------------------------|---|
| Test Methods and Remarks | | Class 1 | | Class 2 |
| | | Standard | High Frequency Type | All items |
| | Preconditioning | None | | Thermal treatment (at 150°C for 1 hr) Note 2 |
| | Temperature | $40 \pm 2^\circ\text{C}$ | $60 \pm 2^\circ\text{C}$ | $40 \pm 2^\circ\text{C}$ |
| | Humidity | 90 to 95%RH | | 90 to 95%RH |
| | Duration | $500 + 24 / - 0$ hrs | | $500 + 24 / - 0$ hrs |
| | Recovery | 6 to 24 hrs (Standard condition) Note 5 | | 24 ± 2 hrs (Standard condition) Note 5 |

16. Humidity Loading

| | | | |
|-----------------|-----------------------------------|---------------------|--|
| Specified Value | Temperature Compensating(Class1) | Standard | Appearance : No abnormality Capacitance change : Within $\pm 7.5\%$ or $\pm 0.75\text{pF}$, whichever is larger. Q : $C < 30\text{pF} : Q \geq 100 + 10C/3$ $C \geq 30\text{pF} : Q \geq 200 (C : \text{Nominal capacitance})$ Insulation resistance : $500 \text{ M}\Omega$ min. |
| | | High Frequency Type | Appearance : No abnormality Capacitance change : $C \leq 2\text{pF} : \text{Within } \pm 0.4 \text{ pF}$ $C > 2\text{pF} : \text{Within } \pm 0.75 \text{ pF}$ (C:Nominal capacitance) Insulation resistance : $500 \text{ M}\Omega$ min. |
| | High Permittivity (Class2) Note 1 | | Appearance : No abnormality Capacitance change : Within $\pm 12.5\%$ Dissipation factor : 5.0% max. Insulation resistance : $25 \text{ M}\Omega \mu\text{F}$ or $500 \text{ M}\Omega$, whichever is smaller. |

| | | | | |
|--------------------------|---|--------------------------|--|---|
| Test Methods and Remarks | | Class 1 | | Class 2 |
| | | Standard | High Frequency Type | All items |
| | Preconditioning | None | | Voltage treatment (Rated voltage are applied for 1 hour at 40°C) Note 3 |
| | Temperature | $40 \pm 2^\circ\text{C}$ | $60 \pm 2^\circ\text{C}$ | $40 \pm 2^\circ\text{C}$ |
| | Humidity | 90 to 95%RH | | 90 to 95%RH |
| | Duration | $500 + 24 / - 0$ hrs | | $500 + 24 / - 0$ hrs |
| | Applied voltage | Rated voltage | | Rated voltage |
| | Charge/discharge current | 50mA max. | | 50mA max. |
| Recovery | 6 to 24 hrs (Standard condition) Note 5 | | 24 ± 2 hrs (Standard condition) Note 5 | |

► This catalog contains the typical specification only due to the limitation of space. When you consider the purchase of our products, please check our specification. For details of each product (characteristics graph, reliability information, precautions for use, and so on), see our Web site (<http://www.ty-top.com/>).

17. High Temperature Loading

| | | | |
|-----------------|-----------------------------------|---------------------|--|
| Specified Value | Temperature Compensating(Class1) | Standard | Appearance : No abnormality Capacitance change : Within $\pm 3\%$ or $\pm 0.3\text{pF}$, whichever is larger. Q : $C < 10\text{pF}$: $Q \geq 200 + 10C$ $10 \leq C < 30\text{pF}$: $Q \geq 275 + 2.5C$ $C \geq 30\text{pF}$: $Q \geq 350$ (C: Nominal capacitance) Insulation resistance : 1000 M Ω min. |
| | | High Frequency Type | Appearance : No abnormality Capacitance change : Within $\pm 3\%$ or $\pm 0.3\text{pF}$, whichever is larger. Insulation resistance : 1000 M Ω min. |
| | High Permittivity (Class2) Note 1 | | Appearance : No abnormality Capacitance change : Within $\pm 12.5\%$ Dissipation factor : 5.0% max. Insulation resistance : 50 M Ω μF or 1000 M Ω , whichever is smaller. |

| | | | | | | |
|--|--------------------------|---------------------------------------|---------------------|---|----|--------|
| Test Methods and Remarks | | Class 1 | | Class 2 | | |
| | | Standard | High Frequency Type | BJ, LD(※) | C6 | B7, C7 |
| | Preconditioning | None | | Voltage treatment (Twice the rated voltage shall be applied for 1 hour at 85°C, 105°C or 125°C) Note 3, 4 | | |
| | Temperature | Maximum operating temperature | | Maximum operating temperature | | |
| | Duration | 1000+48/-0 hrs | | 1000+48/-0 hrs | | |
| | Applied voltage | Rated voltage $\times 2$ Note 4 | | Rated voltage $\times 2$ Note 4 | | |
| | Charge/discharge current | 50mA max. | | 50mA max. | | |
| | Recovery | 6 to 24hr (Standard condition) Note 5 | | 24 ± 2 hrs (Standard condition) Note 5 | | |
| Note: ※LD Low distortion high value multilayer ceramic capacitor | | | | | | |

Note 1 The figures indicate typical specifications. Please refer to individual specifications in detail.

Note 2 Thermal treatment : Initial value shall be measured after test sample is heat-treated at 150+0/-10°C for an hour and kept at room temperature for 24 ± 2 hours.

Note 3 Voltage treatment : Initial value shall be measured after test sample is voltage-treated for an hour at both the temperature and voltage specified in the test conditions, and kept at room temperature for 24 ± 2 hours.

Note 4 150% of rated voltage is applicable to some items. Please refer to their specifications for further information.

Note 5 Standard condition: Temperature: 5 to 35°C, Relative humidity: 45 to 85 % RH, Air pressure: 86 to 106kPa When there are questions concerning measurement results, in order to provide correlation data, the test shall be conducted under the following condition.
Temperature: 20 ± 2 °C, Relative humidity: 60 to 70 % RH, Air pressure: 86 to 106kPa Unless otherwise specified, all the tests are conducted under the "standard condition".

Precautions on the use of Multilayer Ceramic Capacitors

PRECAUTIONS

1. Circuit Design

- Precautions**
- ◆ Verification of operating environment, electrical rating and performance
 1. A malfunction of equipment in fields such as medical, aerospace, nuclear control, etc. may cause serious harm to human life or have severe social ramifications. Therefore, any capacitors to be used in such equipment may require higher safety and reliability, and shall be clearly differentiated from them used in general purpose applications.
 - ◆ Operating Voltage (Verification of Rated voltage)
 1. The operating voltage for capacitors must always be their rated voltage or less. If an AC voltage is loaded on a DC voltage, the sum of the two peak voltages shall be the rated voltage or less. For a circuit where an AC or a pulse voltage may be used, the sum of their peak voltages shall also be the rated voltage or less.
 2. Even if an applied voltage is the rated voltage or less reliability of capacitors may be deteriorated in case that either a high frequency AC voltage or a pulse voltage having rapid rise time is used in a circuit.

2. PCB Design

- Precautions**
- ◆ Pattern configurations (Design of Land-patterns)
 1. When capacitors are mounted on PCBs, the amount of solder used (size of fillet) can directly affect the capacitor performance. Therefore, the following items must be carefully considered in the design of land patterns:
 - (1) Excessive solder applied can cause mechanical stresses which lead to chip breaking or cracking. Therefore, please consider appropriate land-patterns for proper amount of solder.
 - (2) When more than one component are jointly soldered onto the same land, each component's soldering point shall be separated by solder-resist.
 - ◆ Pattern configurations (Capacitor layout on PCBs)
 After capacitors are mounted on boards, they can be subjected to mechanical stresses in subsequent manufacturing processes (PCB cutting, board inspection, mounting of additional parts, assembly into the chassis, wave soldering of the boards, etc.). For this reason, land pattern configurations and positions of capacitors shall be carefully considered to minimize stresses.

◆ Pattern configurations (Design of Land-patterns)
The following diagrams and tables show some examples of recommended land patterns to prevent excessive solder amounts.

(1) Recommended land dimensions for typical chip capacitors

● Multilayer Ceramic Capacitors : Recommended land dimensions (unit: mm)

Wave-soldering

| Type | | 107 | 212 | 316 | 325 |
|------|---|------------|------------|------------|------------|
| Size | L | 1.6 | 2.0 | 3.2 | 3.2 |
| | W | 0.8 | 1.25 | 1.6 | 2.5 |
| A | | 0.8 to 1.0 | 1.0 to 1.4 | 1.8 to 2.5 | 1.8 to 2.5 |
| B | | 0.5 to 0.8 | 0.8 to 1.5 | 0.8 to 1.7 | 0.8 to 1.7 |
| C | | 0.6 to 0.8 | 0.9 to 1.2 | 1.2 to 1.6 | 1.8 to 2.5 |

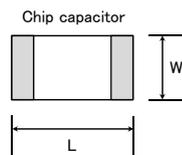
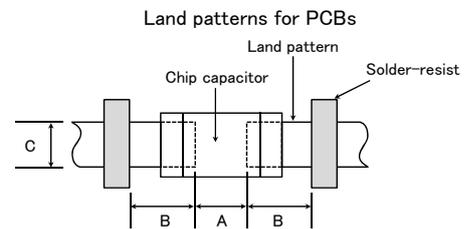

Reflow-soldering

| Type | | 021 | 042 | 063 | 105 | 107 | 212 | 316 | 325 | 432 |
|------|---|-------------|-----------|-----------|-----------|---------|---------|---------|---------|---------|
| Size | L | 0.25 | 0.4 | 0.6 | 1.0 | 1.6 | 2.0 | 3.2 | 3.2 | 4.5 |
| | W | 0.125 | 0.2 | 0.3 | 0.5 | 0.8 | 1.25 | 1.6 | 2.5 | 3.2 |
| A | | 0.095~0.135 | 0.15~0.25 | 0.20~0.30 | 0.45~0.55 | 0.6~0.8 | 0.8~1.2 | 1.8~2.5 | 1.8~2.5 | 2.5~3.5 |
| B | | 0.085~0.125 | 0.10~0.20 | 0.20~0.30 | 0.40~0.50 | 0.6~0.8 | 0.8~1.2 | 1.0~1.5 | 1.0~1.5 | 1.5~1.8 |
| C | | 0.110~0.150 | 0.15~0.30 | 0.25~0.40 | 0.45~0.55 | 0.6~0.8 | 0.9~1.6 | 1.2~2.0 | 1.8~3.2 | 2.3~3.5 |

Note: Recommended land size might be different according to the allowance of the size of the product.

● LWDC: Recommended land dimensions for reflow-soldering (unit: mm)

| Type | | 105 | 107 | 212 |
|------|---|-----------|----------|---------|
| Size | L | 0.52 | 0.8 | 1.25 |
| | W | 1.0 | 1.6 | 2.0 |
| A | | 0.18~0.22 | 0.25~0.3 | 0.5~0.7 |
| B | | 0.2~0.25 | 0.3~0.4 | 0.4~0.5 |
| C | | 0.9~1.1 | 1.5~1.7 | 1.9~2.1 |

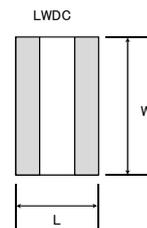

Technical considerations

▶ This catalog contains the typical specification only due to the limitation of space. When you consider the purchase of our products, please check our specification. For details of each product (characteristics graph, reliability information, precautions for use, and so on), see our Web site (<http://www.ty-top.com/>).

(2) Examples of good and bad solder application

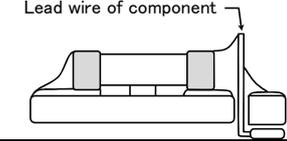
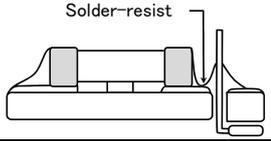
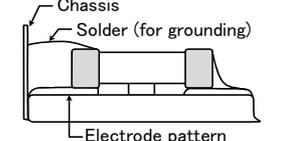
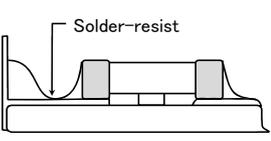
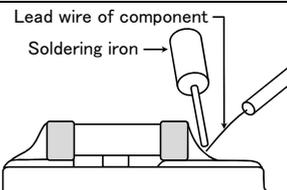
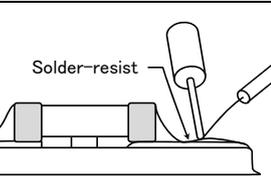
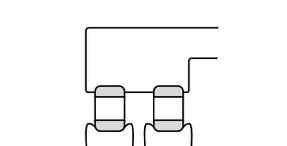
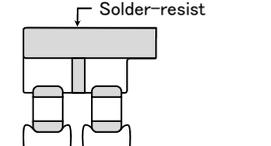
| Item | Not recommended | Recommended |
|---|---|---|
| Mixed mounting of SMD and leaded components |  |  |
| Component placement close to the chassis |  |  |
| Hand-soldering of leaded components near mounted components |  |  |
| Horizontal component placement |  |  |

◆ Pattern configurations (Capacitor layout on PCBs)

1-1. The following is examples of good and bad capacitor layouts ; capacitors shall be located to minimize any possible mechanical stresses from board warp or deflection.

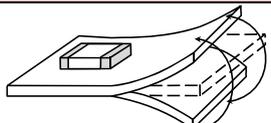
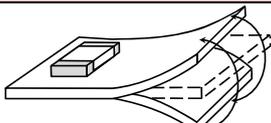
| Items | Not recommended | Recommended |
|---------------------|--|---|
| Deflection of board |  |  Place the product at a right angle to the direction of the anticipated mechanical stress. |

1-2. The amount of mechanical stresses given will vary depending on capacitor layout. Please refer to diagram below.

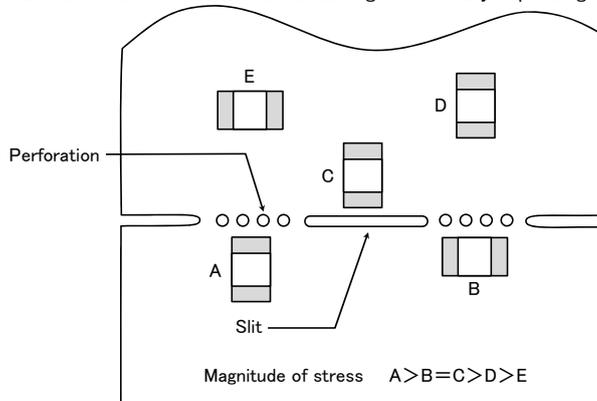

1-3. When PCB is split, the amount of mechanical stress on the capacitors can vary according to the method used. The following methods are listed in order from least stressful to most stressful: push-back, slit, V-grooving, and perforation. Thus, please consider the PCB, split methods as well as chip location.

3. Mounting

Precautions

◆ Adjustment of mounting machine

- When capacitors are mounted on PCB, excessive impact load shall not be imposed on them.
- Maintenance and inspection of mounting machines shall be conducted periodically.

◆ Selection of Adhesives

- When chips are attached on PCBs with adhesives prior to soldering, it may cause capacitor characteristics degradation unless the following factors are appropriately checked : size of land patterns, type of adhesive, amount applied, hardening temperature and hardening period. Therefore, please contact us for further information.

◆Adjustment of mounting machine

1. When the bottom dead center of a pick-up nozzle is too low, excessive force is imposed on capacitors and causes damages. To avoid this, the following points shall be considerable.
 - (1) The bottom dead center of the pick-up nozzle shall be adjusted to the surface level of PCB without the board deflection.
 - (2) The pressure of nozzle shall be adjusted between 1 and 3 N static loads.
 - (3) To reduce the amount of deflection of the board caused by impact of the pick-up nozzle, supporting pins or back-up pins shall be used on the other side of the PCB. The following diagrams show some typical examples of good and bad pick-up nozzle placement:

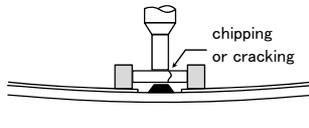
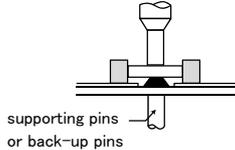
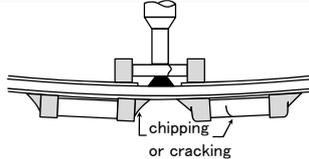
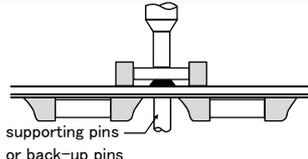
| Item | Improper method | Proper method |
|-----------------------|---|---|
| Single-sided mounting |  |  |
| Double-sided mounting |  |  |

Technical considerations

2. As the alignment pin is worn out, adjustment of the nozzle height can cause chipping or cracking of capacitors because of mechanical impact on the capacitors. To avoid this, the monitoring of the width between the alignment pins in the stopped position, maintenance, check and replacement of the pin shall be conducted periodically.

◆Selection of Adhesives

Some adhesives may cause IR deterioration. The different shrinkage percentage of between the adhesive and the capacitors may result in stresses on the capacitors and lead to cracking. Moreover, too little or too much adhesive applied to the board may adversely affect components. Therefore, the following precautions shall be noted in the application of adhesives.

- (1) Required adhesive characteristics
 - a. The adhesive shall be strong enough to hold parts on the board during the mounting & solder process.
 - b. The adhesive shall have sufficient strength at high temperatures.
 - c. The adhesive shall have good coating and thickness consistency.
 - d. The adhesive shall be used during its prescribed shelf life.
 - e. The adhesive shall harden rapidly.
 - f. The adhesive shall have corrosion resistance.
 - g. The adhesive shall have excellent insulation characteristics.
 - h. The adhesive shall have no emission of toxic gasses and no effect on the human body.
- (2) The recommended amount of adhesives is as follows;

[Recommended condition]

| Figure | 212/316 case sizes as examples |
|--------|----------------------------------|
| a | 0.3mm min |
| b | 100 to 120 μm |
| c | Adhesives shall not contact land |

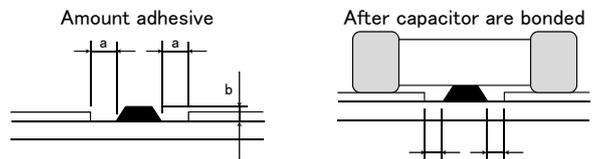

4. Soldering

◆Selection of Flux

- Since flux may have a significant effect on the performance of capacitors, it is necessary to verify the following conditions prior to use;
- (1) Flux used shall be less than or equal to 0.1 wt% (in Cl equivalent) of halogenated content. Flux having a strong acidity content shall not be applied.
 - (2) When shall capacitors are soldered on boards, the amount of flux applied shall be controlled at the optimum level.
 - (3) When water-soluble flux is used, special care shall be taken to properly clean the boards.

Precautions

◆Soldering

Temperature, time, amount of solder, etc. shall be set in accordance with their recommended conditions.
 Sn-Zn solder paste can adversely affect MLOC reliability.
 Please contact us prior to usage of Sn-Zn solder.

Technical considerations

◆Selection of Flux

- 1-1. When too much halogenated substance (Chlorine, etc.) content is used to activate flux, or highly acidic flux is used, it may lead to corrosion of terminal electrodes or degradation of insulation resistance on the surfaces of the capacitors.
- 1-2. Flux is used to increase solderability in wave soldering. However if too much flux is applied, a large amount of flux gas may be emitted and may adversely affect the solderability. To minimize the amount of flux applied, it is recommended to use a flux-bubbling system.
- 1-3. Since the residue of water-soluble flux is easily dissolved in moisture in the air, the residues on the surfaces of capacitors in high humidity conditions may cause a degradation of insulation resistance and reliability of the capacitors. Therefore, the cleaning methods and the capability of the machines used shall also be considered carefully when water-soluble flux is used.

▶ This catalog contains the typical specification only due to the limitation of space. When you consider the purchase of our products, please check our specification. For details of each product (characteristics graph, reliability information, precautions for use, and so on), see our Web site (<http://www.ty-top.com/>).

◆ Soldering

- Ceramic chip capacitors are susceptible to thermal shock when exposed to rapid or concentrated heating or rapid cooling.
- Therefore, the soldering must be conducted with great care so as to prevent malfunction of the components due to excessive thermal shock.
- Preheating : Capacitors shall be preheated sufficiently, and the temperature difference between the capacitors and solder shall be within 130°C.
- Cooling : The temperature difference between the capacitors and cleaning process shall not be greater than 100°C.

[Reflow soldering]

【Recommended conditions for eutectic soldering】

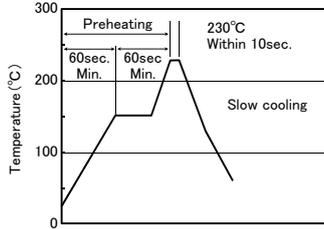

【Recommended condition for Pb-free soldering】

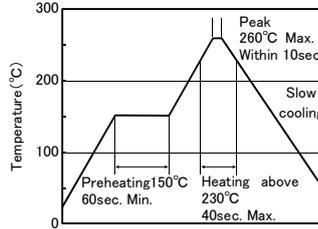

Caution

- ① The ideal condition is to have solder mass (fillet) controlled to 1/2 to 1/3 of the thickness of a capacitor.
- ② Because excessive dwell times can adversely affect solderability, soldering duration shall be kept as close to recommended times as possible. soldering for 2 times.

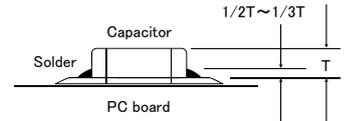

[Wave soldering]

【Recommended conditions for eutectic soldering】

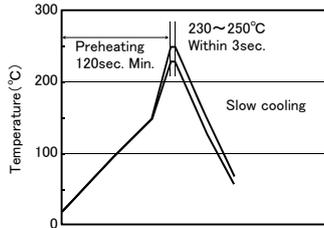

【Recommended condition for Pb-free soldering】

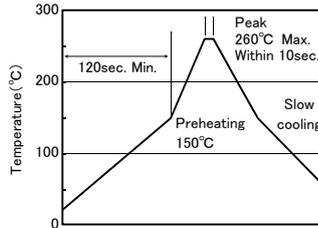

Caution

- ① Wave soldering must not be applied to capacitors designated as for reflow soldering only. soldering for 1 times.

[Hand soldering]

【Recommended conditions for eutectic soldering】

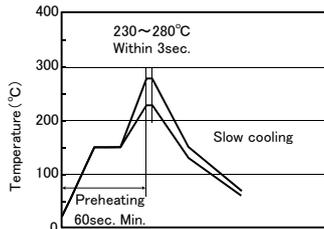

【Recommended condition for Pb-free soldering】

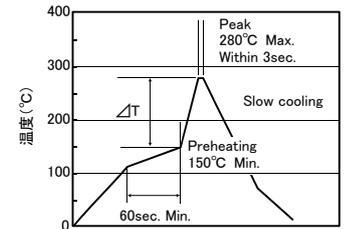
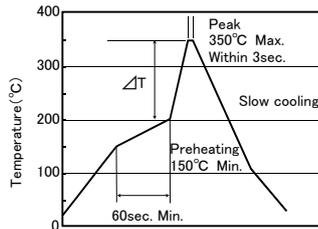

| | |
|-----------------|-------------------------------------|
| 316type or less | $\Delta T \leq 150^{\circ}\text{C}$ |
|-----------------|-------------------------------------|

| | |
|-----------------|-------------------------------------|
| 325type or more | $\Delta T \leq 130^{\circ}\text{C}$ |
|-----------------|-------------------------------------|

Caution

- ① Use a 50W soldering iron with a maximum tip diameter of 1.0 mm.
- ② The soldering iron shall not directly touch capacitors. soldering for 1 times.

| 5. Cleaning | |
|--------------------------|---|
| Precautions | <p>◆Cleaning conditions</p> <ol style="list-style-type: none"> When PCBs are cleaned after capacitors mounting, please select the appropriate cleaning solution in accordance with the intended use of the cleaning. (e.g. to remove soldering flux or other materials from the production process.) Cleaning condition shall be determined after it is verified by using actual cleaning machine that the cleaning process does not affect capacitor's characteristics. |
| Technical considerations | <ol style="list-style-type: none"> The use of inappropriate cleaning solutions can cause foreign substances such as flux residue to adhere to capacitors or deteriorate their outer coating, resulting in a degradation of the capacitor's electrical properties (especially insulation resistance). Inappropriate cleaning conditions (insufficient or excessive cleaning) may adversely affect the performance of the capacitors. In the case of ultrasonic cleaning, too much power output can cause excessive vibration of PCBs which may lead to the cracking of capacitors or the soldered portion, or decrease the terminal electrodes' strength. Therefore, the following conditions shall be carefully checked; Ultrasonic output : 20 W/l or less Ultrasonic frequency : 40 kHz or less Ultrasonic washing period : 5 min. or less |

| 6. Resin coating and mold | |
|---------------------------|--|
| Precautions | <ol style="list-style-type: none"> With some type of resins, decomposition gas or chemical reaction vapor may remain inside the resin during the hardening period or while left under normal storage conditions resulting in the deterioration of the capacitor's performance. When a resin's hardening temperature is higher than capacitor's operating temperature, the stresses generated by the excessive heat may lead to damage or destruction of capacitors. The use of such resins, molding materials etc. is not recommended. |

| 7. Handling | |
|-------------|--|
| Precautions | <p>◆Splitting of PCB</p> <ol style="list-style-type: none"> When PCBs are split after components mounting, care shall be taken so as not to give any stresses of deflection or twisting to the board. Board separation shall not be done manually, but by using the appropriate devices. <p>◆Mechanical considerations</p> <p>Be careful not to subject capacitors to excessive mechanical shocks.</p> <p>(1) If ceramic capacitors are dropped onto a floor or a hard surface, they shall not be used.</p> <p>(2) Please be careful that the mounted components do not come in contact with or bump against other boards or components.</p> |

| 8. Storage conditions | |
|--------------------------|---|
| Precautions | <p>◆Storage</p> <ol style="list-style-type: none"> To maintain the solderability of terminal electrodes and to keep packaging materials in good condition, care must be taken to control temperature and humidity in the storage area. Humidity should especially be kept as low as possible. <ul style="list-style-type: none"> Recommended conditions Ambient temperature : Below 30°C Humidity : Below 70% RH The ambient temperature must be kept below 40°C. Even under ideal storage conditions, solderability of capacitor is deteriorated as time passes, so capacitors shall be used within 6 months from the time of delivery. Ceramic chip capacitors shall be kept where no chlorine or sulfur exists in the air. The capacitance values of high dielectric constant capacitors will gradually decrease with the passage of time, so care shall be taken to design circuits. Even if capacitance value decreases as time passes, it will get back to the initial value by a heat treatment at 150°C for 1 hour. |
| Technical considerations | <p>If capacitors are stored in a high temperature and humidity environment, it might rapidly cause poor solderability due to terminal oxidation and quality loss of taping/packaging materials. For this reason, capacitors shall be used within 6 months from the time of delivery. If exceeding the above period, please check solderability before using the capacitors.</p> |

※RCR-2335B (Safety Application Guide for fixed ceramic capacitors for use in electronic equipment) is published by JEITA.

Please check the guide regarding precautions for deflection test, soldering by spot heat, and so on.

Компания «Океан Электроники» предлагает заключение долгосрочных отношений при поставках импортных электронных компонентов на взаимовыгодных условиях!

Наши преимущества:

- Поставка оригинальных импортных электронных компонентов напрямую с производств Америки, Европы и Азии, а так же с крупнейших складов мира;
- Широкая линейка поставок активных и пассивных импортных электронных компонентов (более 30 млн. наименований);
- Поставка сложных, дефицитных, либо снятых с производства позиций;
- Оперативные сроки поставки под заказ (от 5 рабочих дней);
- Экспресс доставка в любую точку России;
- Помощь Конструкторского Отдела и консультации квалифицированных инженеров;
- Техническая поддержка проекта, помощь в подборе аналогов, поставка прототипов;
- Поставка электронных компонентов под контролем ВП;
- Система менеджмента качества сертифицирована по Международному стандарту ISO 9001;
- При необходимости вся продукция военного и аэрокосмического назначения проходит испытания и сертификацию в лаборатории (по согласованию с заказчиком);
- Поставка специализированных компонентов военного и аэрокосмического уровня качества (Xilinx, Altera, Analog Devices, Intersil, Interpoint, Microsemi, Actel, Aeroflex, Peregrine, VPT, Syfer, Eurofarad, Texas Instruments, MS Kennedy, Miteq, Cobham, E2V, MA-COM, Hittite, Mini-Circuits, General Dynamics и др.);

Компания «Океан Электроники» является официальным дистрибьютором и эксклюзивным представителем в России одного из крупнейших производителей разъемов военного и аэрокосмического назначения «JONHON», а так же официальным дистрибьютором и эксклюзивным представителем в России производителя высокотехнологичных и надежных решений для передачи СВЧ сигналов «FORSTAR».



JONHON

«JONHON» (основан в 1970 г.)

Разъемы специального, военного и аэрокосмического назначения:

(Применяются в военной, авиационной, аэрокосмической, морской, железнодорожной, горно- и нефтедобывающей отраслях промышленности)

«FORSTAR» (основан в 1998 г.)

ВЧ соединители, коаксиальные кабели, кабельные сборки и микроволновые компоненты:

(Применяются в телекоммуникациях гражданского и специального назначения, в средствах связи, РЛС, а так же военной, авиационной и аэрокосмической отраслях промышленности).



Телефон: 8 (812) 309-75-97 (многоканальный)

Факс: 8 (812) 320-03-32

Электронная почта: ocean@oceanchips.ru

Web: <http://oceanchips.ru/>

Адрес: 198099, г. Санкт-Петербург, ул. Калинина, д. 2, корп. 4, лит. А