

# SP series

Washable snap-action pushbutton switches



## DISTINCTIVE FEATURES

Process sealed

Front and rear sealing

Process compatible (plain bushing models)

Wave solderable

Washable



## ELECTRICAL SPECIFICATIONS

- Max. current/voltage rating with resistive load :
  - gold plated brass contacts : 100 mA 30 VDC
  - silver or gold plated silver contacts : 1 A 30 VDC
- Initial contact resistance : 50 mΩ max.
- Insulation resistance : 1,000 MΩ min.
- Dielectric strength : 1,000 Vrms 50 Hz min.
- Electrical life : 60,000 cycles



## ENVIRONMENTAL SPECIFICATIONS

- Operating temperature : -20 °C to +85 °C (-4 °F to +185 °F)
- Storage temperature : -40 °C to +85 °C (-40 °F to +185 °F)
- Moisture : The insulating materials employed and the complete seal permit the switches to withstand a 56 days moisture test (IEC 68-2-3).
- Solderability : The switches are tested at 235°C according to IEC 68-2-20 after accelerated aging.



## GENERAL SPECIFICATIONS

- Torque : 0.25 Nm (.18 Ft.lb) applied to nut (threaded bushing)
- Total travel : 0.50 mm (.019)
- Mechanical strength : Terminals are strengthened by a bracket or a ground plate ensuring the rigidity of the switch on the board. Actuator strength is 10 N max.
- Soldering - thermal shock (plain bushing models only) :  
The switches are especially designed for flow soldering at 260 °C (500 °F) during 5 seconds owing to high temperature polymer parts.
- Iron soldering (threaded bushing models) : 300 °C (572 °F) max., 5 seconds max.

The company reserves the right to change specifications without notice.



# SP series

Washable snap-action pushbutton switches



## MATERIALS

- Case and cover : UL94-V0, polyamide, glass filled or PES
- Actuator : polyamide, glass filled
- Contacts
  - 0 : brass, gold plated
  - 1 : silver
  - 2 : silver, gold plated
- Terminal seal : epoxy

APEM products may be recycled at end-of-life for the re-claiming of valuable metal components.

## AGENCY APPROVAL



1 A 120 VAC

**Availability** : all models with silver or gold plated silver contacts.

**Marking** : to order switches marked UL , complete appropriate box of ordering format.



## TERMINALS

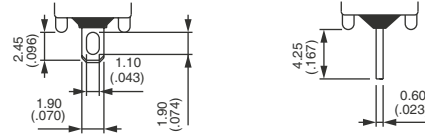

## ELECTRICAL FUNCTIONS

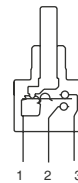

## PANEL CUT-OUT

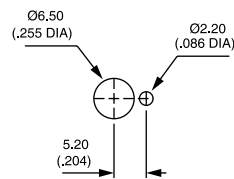



### BUILD YOUR PART NUMBER

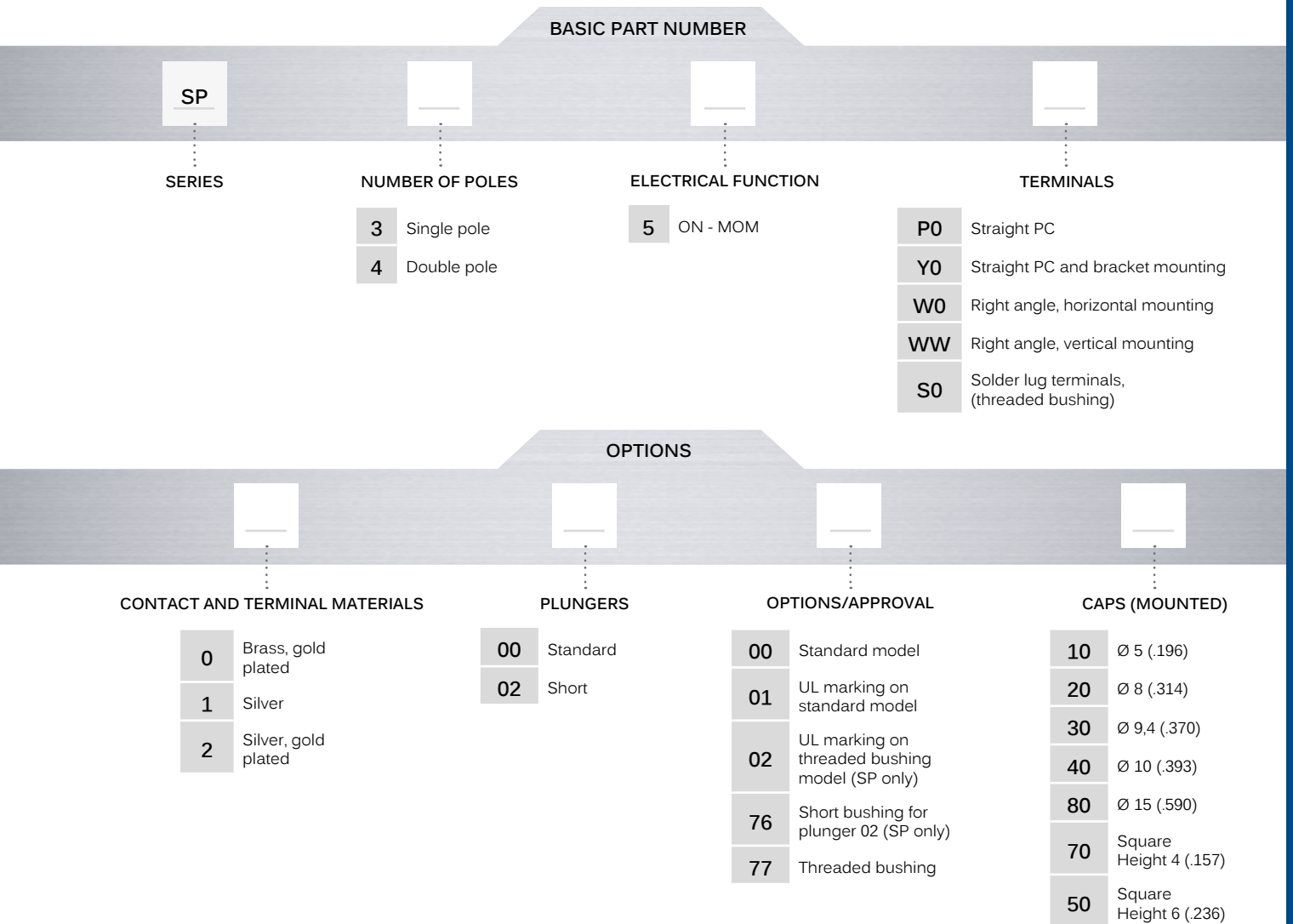

### ABOUT THIS SERIES

On the following pages, you will find successively basic part numbers of switches and options in the same order as in above chart.



**Notice** : please note that not all combinations of above numbers are available. Refer to the following pages for further information.



**Mounting accessories** : Standard hardware supplied with all models with Ø 6.35 (1/4) threaded bushing : 2 hex nuts 8 mm (.314) across flats, 1 locking ring and 1 lockwasher. Standard and special hardware available is presented in the "Accessories" section of website.

# SP series

Washable snap-action pushbutton switches

## PLAIN BUSHING - STRAIGHT PC TERMINALS



Single pole	1-3	1-2
<b>SP35P0... 00</b>	ON	MOM
Double pole	1-3	1-2
<b>SP45P0... 00</b>	ON	MOM

Shown with standard plunger

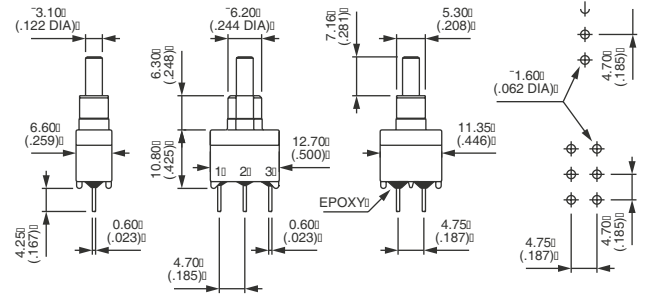

## PLAIN BUSHING - BRACKET MOUNTING



Single pole	1-3	1-2
<b>SP35Y0... 00</b>	ON	MOM
Double pole	1-3	1-2
<b>SP45Y0... 00</b>	ON	MOM

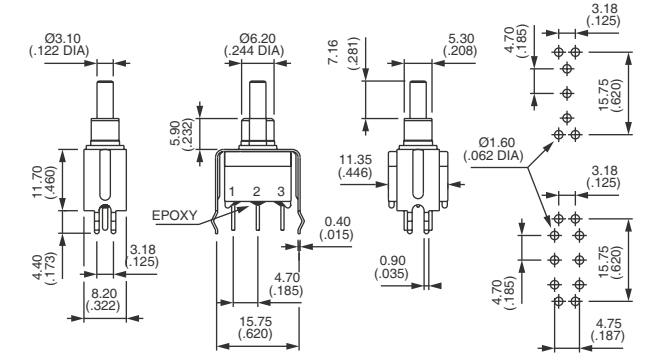

## PLAIN BUSHING - RIGHT ANGLE TERMINALS HORIZONTAL



Single pole	1-3	1-2
<b>SP35W0... 00</b>	ON	MOM
Double pole	1-3	1-2
<b>SP45W0... 00</b>	ON	MOM

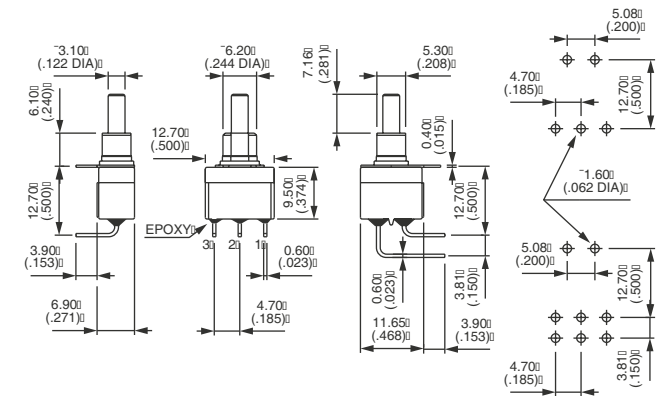

## PLAIN BUSHING - RIGHT ANGLE TERMINALS VERTICAL



Single pole	1-3	1-2
<b>SP35WW... 00</b>	ON	MOM
Double pole	1-3	1-2
<b>SP45WW... 00</b>	ON	MOM

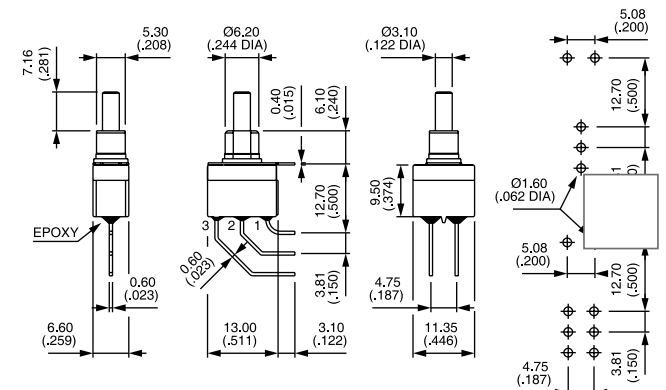

Washable snap-action pushbutton switches

## THREADED BUSHING - SOLDER LUG TERMINALS



Single pole  
SP35S0... 77



1-3



1-2

ON

MOM

Shown with standard plunger  
→ KEYWAY

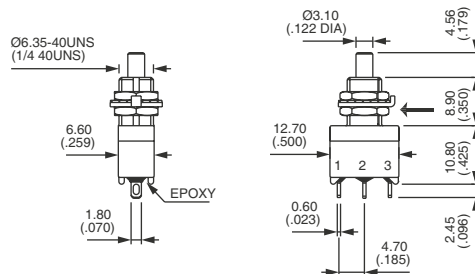

## THREADED BUSHING - STRAIGHT PC TERMINALS



Single pole  
SP35P0... 77



1-3



1-2

ON

MOM

→ KEYWAY

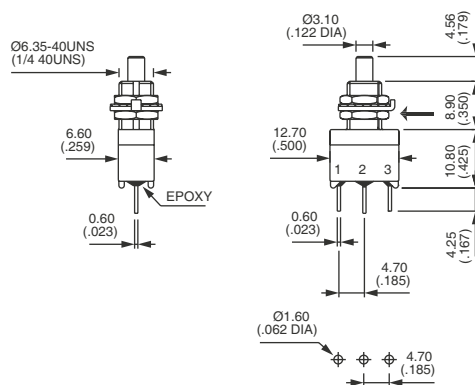

### CONTACT & TERMINAL MATERIALS

BASIC P/N

- 0 Brass, gold plated (standard)
- 1 Silver
- 2 Silver, gold plated

### PLUNGERS

BASIC P/N

- 00 Standard plunger
- 02 Short (for models with plain bushing, single pole only) Order with option 76 below.

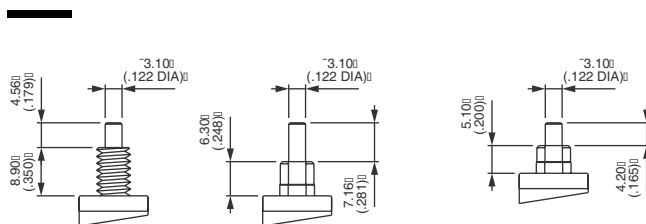

00

02

# SP series

Washable snap-action pushbutton switches

### OPTIONS / AGENCY APPROVAL

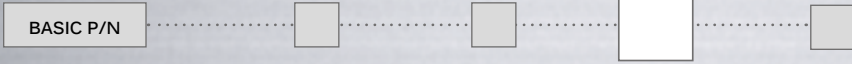

- 00 Standard model
- 01 UL marking for standard model
- 02 UL marking for threaded bushing model (single pole models only)
- 76 Short plain bushing for 02 plunger (single pole models only)
- 77 Threaded bushing (included in basic part numbers on previous page)

### CAPS

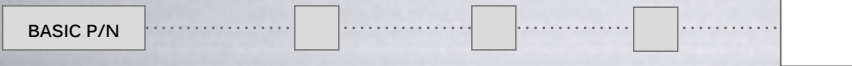

- |  |   |
|--|---|
| <b>Blank</b> Without cap                             | For cap colors, replace «0» with number : |
| 10 P/N U2400   | 1 Blue                                    |
| 20 P/N U2510   | 1/4 Dark blue                             |
| 30 P/N U2130   | 2 Black                                   |
| 40 Standard - P/N U2900                              | 3 Green                                   |
| 50 Square - P/N U2340. Not available with plunger 02 | 4 Grey                                    |
| 70 Square - P/N U910                                 | 5 Yellow                                  |
| 80 P/N U3400. Not available with plunger 02          | 6 Red                                     |
|  | 7 Ivory                                   |
|  | 7/1 White                                 |
|  | 9 Orange                                  |

To order caps separately, use their P/N (U...) (for threaded bushing order only separately).

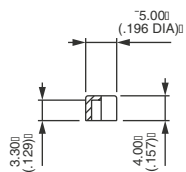

10

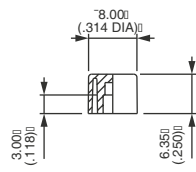

20

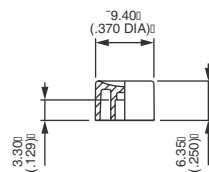

30

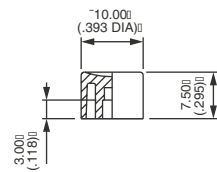

40

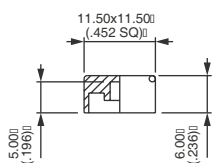

50

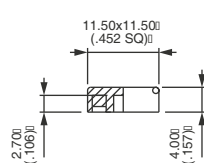

70

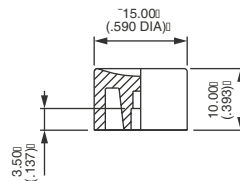

80

## DRESS NUT

**For threaded bushing models only**  
 Dress nuts are to be ordered separately.

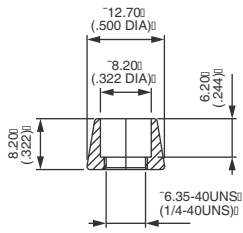

**U1636**  
 For cap U2510

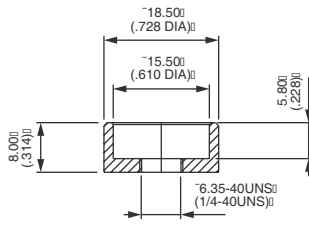

**U825**  
 For cap U3400

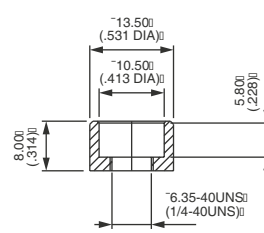

**U840**  
 For cap U2900

Компания «Океан Электроники» предлагает заключение долгосрочных отношений при поставках импортных электронных компонентов на взаимовыгодных условиях!

Наши преимущества:

- Поставка оригинальных импортных электронных компонентов напрямую с производств Америки, Европы и Азии, а так же с крупнейших складов мира;
- Широкая линейка поставок активных и пассивных импортных электронных компонентов (более 30 млн. наименований);
- Поставка сложных, дефицитных, либо снятых с производства позиций;
- Оперативные сроки поставки под заказ (от 5 рабочих дней);
- Экспресс доставка в любую точку России;
- Помощь Конструкторского Отдела и консультации квалифицированных инженеров;
- Техническая поддержка проекта, помощь в подборе аналогов, поставка прототипов;
- Поставка электронных компонентов под контролем ВП;
- Система менеджмента качества сертифицирована по Международному стандарту ISO 9001;
- При необходимости вся продукция военного и аэрокосмического назначения проходит испытания и сертификацию в лаборатории (по согласованию с заказчиком);
- Поставка специализированных компонентов военного и аэрокосмического уровня качества (Xilinx, Altera, Analog Devices, Intersil, Interpoint, Microsemi, Actel, Aeroflex, Peregrine, VPT, Syfer, Eurofarad, Texas Instruments, MS Kennedy, Miteq, Cobham, E2V, MA-COM, Hittite, Mini-Circuits, General Dynamics и др.);

Компания «Океан Электроники» является официальным дистрибьютором и эксклюзивным представителем в России одного из крупнейших производителей разъемов военного и аэрокосмического назначения «JONHON», а так же официальным дистрибьютором и эксклюзивным представителем в России производителя высокотехнологичных и надежных решений для передачи СВЧ сигналов «FORSTAR».



## JONHON

«JONHON» (основан в 1970 г.)

Разъемы специального, военного и аэрокосмического назначения:

(Применяются в военной, авиационной, аэрокосмической, морской, железнодорожной, горно- и нефтедобывающей отраслях промышленности)

«FORSTAR» (основан в 1998 г.)

ВЧ соединители, коаксиальные кабели, кабельные сборки и микроволновые компоненты:

(Применяются в телекоммуникациях гражданского и специального назначения, в средствах связи, РЛС, а так же военной, авиационной и аэрокосмической отраслях промышленности).



Телефон: 8 (812) 309-75-97 (многоканальный)

Факс: 8 (812) 320-03-32

Электронная почта: [ocean@oceanchips.ru](mailto:ocean@oceanchips.ru)

Web: <http://oceanchips.ru/>

Адрес: 198099, г. Санкт-Петербург, ул. Калинина, д. 2, корп. 4, лит. А