

SP series

Washable snap-action pushbutton switches



DISTINCTIVE FEATURES

Process sealed

Front and rear sealing

Process compatible (plain bushing models)

Wave solderable

Washable



ELECTRICAL SPECIFICATIONS

- Max. current/voltage rating with resistive load :
 - gold plated brass contacts : 100 mA 30 VDC
 - silver or gold plated silver contacts : 1 A 30 VDC
- Initial contact resistance : 50 mΩ max.
- Insulation resistance : 1,000 MΩ min.
- Dielectric strength : 1,000 Vrms 50 Hz min.
- Electrical life : 60,000 cycles



ENVIRONMENTAL SPECIFICATIONS

- Operating temperature : -20 °C to +85 °C (-4 °F to +185 °F)
- Storage temperature : -40 °C to +85 °C (-40 °F to +185 °F)
- Moisture : The insulating materials employed and the complete seal permit the switches to withstand a 56 days moisture test (IEC 68-2-3).
- Solderability : The switches are tested at 235°C according to IEC 68-2-20 after accelerated aging.



GENERAL SPECIFICATIONS

- Torque : 0.25 Nm (.18 Ft.lb) applied to nut (threaded bushing)
- Total travel : 0.50 mm (.019)
- Mechanical strength : Terminals are strengthened by a bracket or a ground plate ensuring the rigidity of the switch on the board. Actuator strength is 10 N max.
- Soldering - thermal shock (plain bushing models only) :
The switches are especially designed for flow soldering at 260 °C (500 °F) during 5 seconds owing to high temperature polymer parts.
- Iron soldering (threaded bushing models) : 300 °C (572 °F) max., 5 seconds max.

The company reserves the right to change specifications without notice.



SP series

Washable snap-action pushbutton switches



MATERIALS

- Case and cover : UL94-V0, polyamide, glass filled or PES
- Actuator : polyamide, glass filled
- Contacts
 - 0 : brass, gold plated
 - 1 : silver
 - 2 : silver, gold plated
- Terminal seal : epoxy

APEM products may be recycled at end-of-life for the re-claiming of valuable metal components.

AGENCY APPROVAL



1 A 120 VAC

Availability : all models with silver or gold plated silver contacts.

Marking : to order switches marked UL , complete appropriate box of ordering format.



TERMINALS

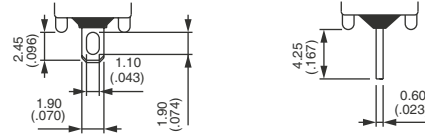

ELECTRICAL FUNCTIONS

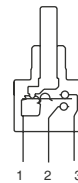

PANEL CUT-OUT

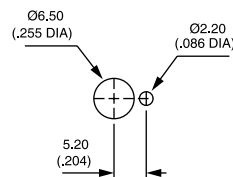



BUILD YOUR PART NUMBER

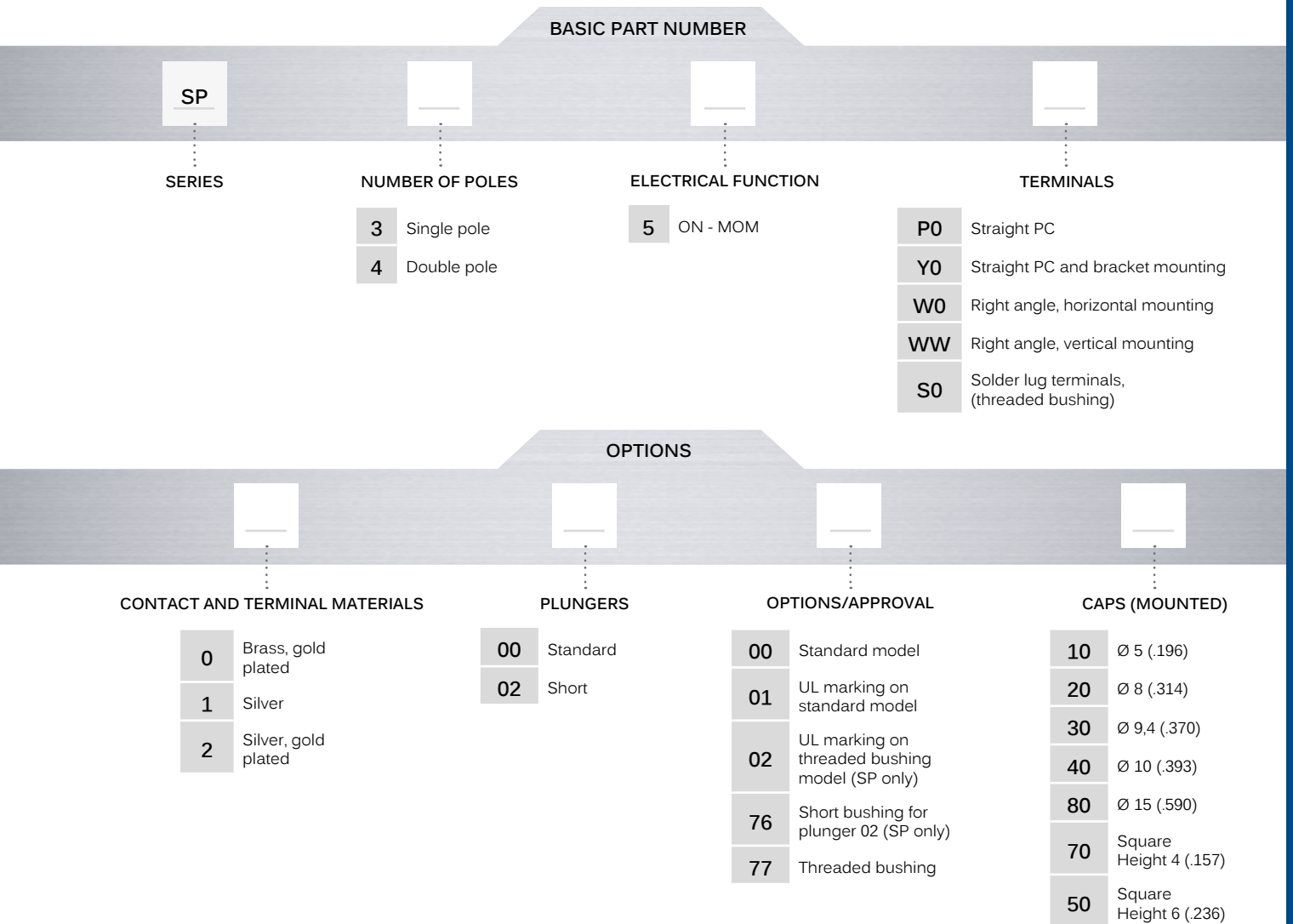

ABOUT THIS SERIES

On the following pages, you will find successively basic part numbers of switches and options in the same order as in above chart.



Notice : please note that not all combinations of above numbers are available. Refer to the following pages for further information.



Mounting accessories : Standard hardware supplied with all models with Ø 6.35 (1/4) threaded bushing : 2 hex nuts 8 mm (.314) across flats, 1 locking ring and 1 lockwasher. Standard and special hardware available is presented in the "Accessories" section of website.

SP series

Washable snap-action pushbutton switches

PLAIN BUSHING - STRAIGHT PC TERMINALS



	Single pole				
	SP35P0... 00	ON			MOM
	Double pole				
	SP45P0... 00	ON			MOM

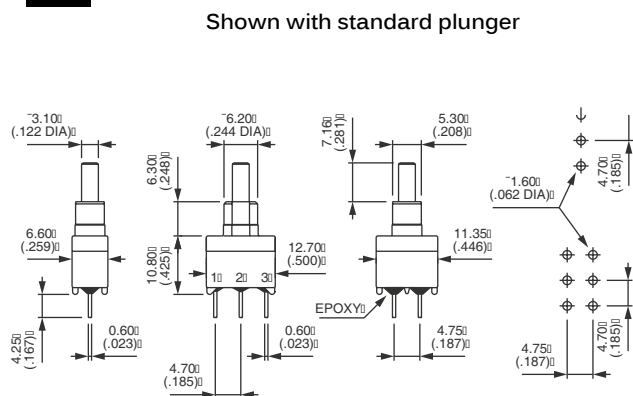

PLAIN BUSHING - BRACKET MOUNTING



	Single pole				
	SP35Y0... 00	ON			MOM
	Double pole				
	SP45Y0... 00	ON			MOM

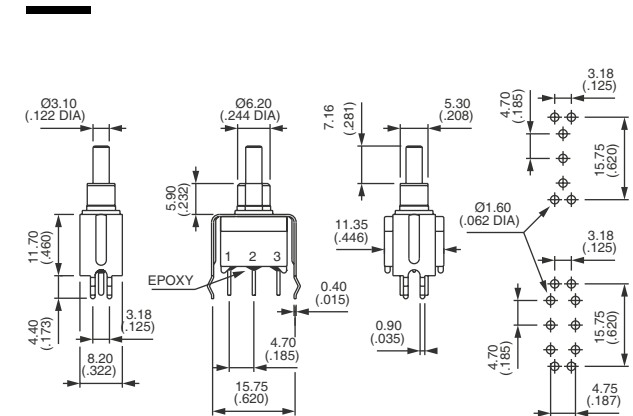

PLAIN BUSHING - RIGHT ANGLE TERMINALS HORIZONTAL



	Single pole				
	SP35W0... 00	ON			MOM
	Double pole				
	SP45W0... 00	ON			MOM

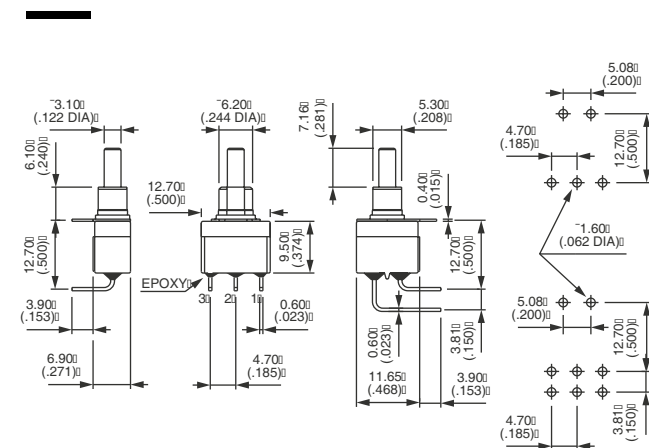

PLAIN BUSHING - RIGHT ANGLE TERMINALS VERTICAL



	Single pole				
	SP35WW... 00	ON			MOM
	Double pole				
	SP45WW... 00	ON			MOM

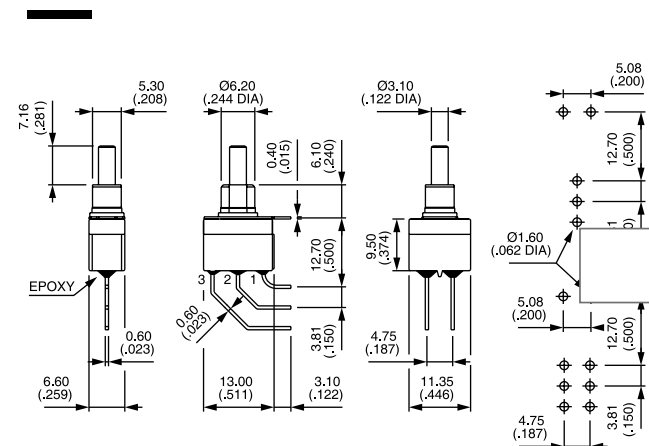

Washable snap-action pushbutton switches

THREADED BUSHING - SOLDER LUG TERMINALS



Single pole
SP35S0... 77



1-3



1-2

ON

MOM

Shown with standard plunger
→ KEYWAY

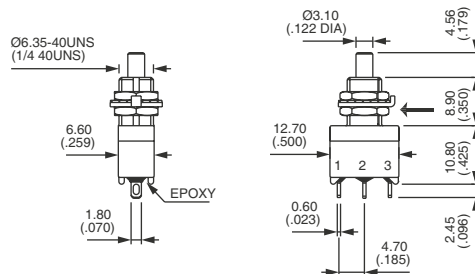

THREADED BUSHING - STRAIGHT PC TERMINALS



Single pole
SP35P0... 77



1-3



1-2

ON

MOM

→ KEYWAY

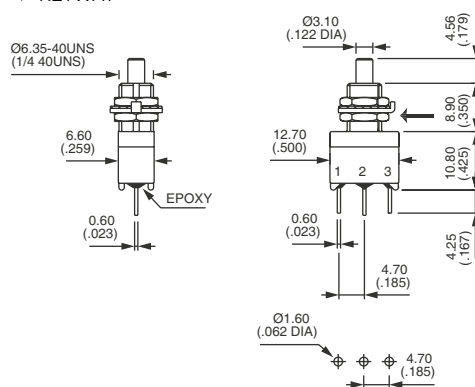

CONTACT & TERMINAL MATERIALS

BASIC P/N

- 0 Brass, gold plated (standard)
- 1 Silver
- 2 Silver, gold plated

PLUNGERS

BASIC P/N

- 00 Standard plunger
- 02 Short (for models with plain bushing, single pole only) Order with option 76 below.

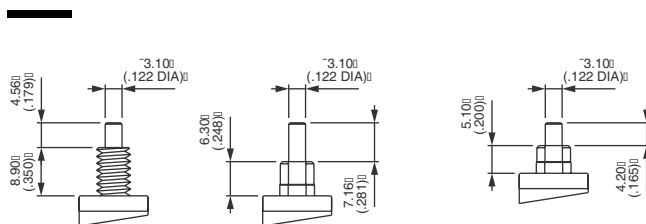

00

02

SP series

Washable snap-action pushbutton switches

OPTIONS / AGENCY APPROVAL

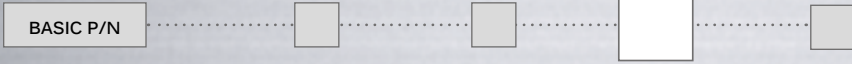

- 00 Standard model
- 01 UL marking for standard model
- 02 UL marking for threaded bushing model (single pole models only)
- 76 Short plain bushing for 02 plunger (single pole models only)
- 77 Threaded bushing (included in basic part numbers on previous page)

CAPS

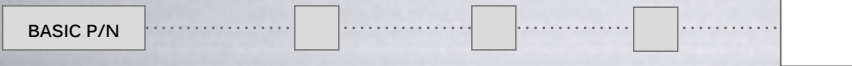

- | | |
|--|---|
| Blank Without cap | For cap colors, replace «0» with number : |
| 10 P/N U2400 | 1 Blue |
| 20 P/N U2510 | 1/4 Dark blue |
| 30 P/N U2130 | 2 Black |
| 40 Standard - P/N U2900 | 3 Green |
| 50 Square - P/N U2340. Not available with plunger 02 | 4 Grey |
| 70 Square - P/N U910 | 5 Yellow |
| 80 P/N U3400. Not available with plunger 02 | 6 Red |
| | 7 Ivory |
| | 7/1 White |
| | 9 Orange |

To order caps separately, use their P/N (U...) (for threaded bushing order only separately).

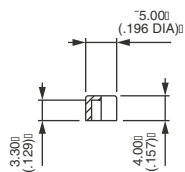

10

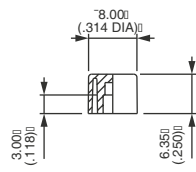

20

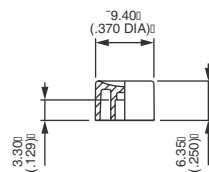

30

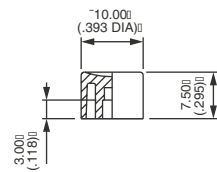

40

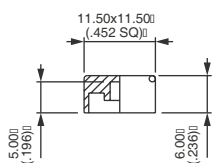

50

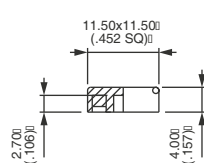

70

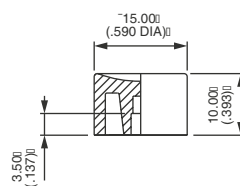

80

DRESS NUT

For threaded bushing models only
Dress nuts are to be ordered separately.

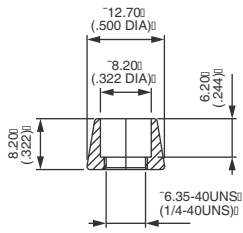

U1636
For cap U2510

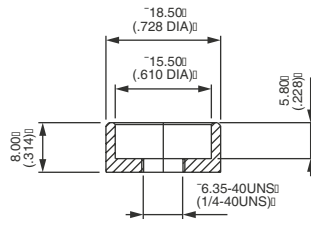

U825
For cap U3400

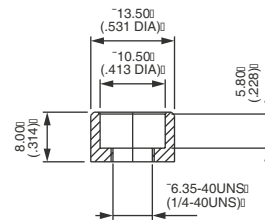

U840
For cap U2900

Компания «Океан Электроники» предлагает заключение долгосрочных отношений при поставках импортных электронных компонентов на взаимовыгодных условиях!

Наши преимущества:

- Поставка оригинальных импортных электронных компонентов напрямую с производств Америки, Европы и Азии, а так же с крупнейших складов мира;
- Широкая линейка поставок активных и пассивных импортных электронных компонентов (более 30 млн. наименований);
- Поставка сложных, дефицитных, либо снятых с производства позиций;
- Оперативные сроки поставки под заказ (от 5 рабочих дней);
- Экспресс доставка в любую точку России;
- Помощь Конструкторского Отдела и консультации квалифицированных инженеров;
- Техническая поддержка проекта, помощь в подборе аналогов, поставка прототипов;
- Поставка электронных компонентов под контролем ВП;
- Система менеджмента качества сертифицирована по Международному стандарту ISO 9001;
- При необходимости вся продукция военного и аэрокосмического назначения проходит испытания и сертификацию в лаборатории (по согласованию с заказчиком);
- Поставка специализированных компонентов военного и аэрокосмического уровня качества (Xilinx, Altera, Analog Devices, Intersil, Interpoint, Microsemi, Actel, Aeroflex, Peregrine, VPT, Syfer, Eurofarad, Texas Instruments, MS Kennedy, Miteq, Cobham, E2V, MA-COM, Hittite, Mini-Circuits, General Dynamics и др.);

Компания «Океан Электроники» является официальным дистрибьютором и эксклюзивным представителем в России одного из крупнейших производителей разъемов военного и аэрокосмического назначения «JONHON», а так же официальным дистрибьютором и эксклюзивным представителем в России производителя высокотехнологичных и надежных решений для передачи СВЧ сигналов «FORSTAR».



JONHON

«JONHON» (основан в 1970 г.)

Разъемы специального, военного и аэрокосмического назначения:

(Применяются в военной, авиационной, аэрокосмической, морской, железнодорожной, горно- и нефтедобывающей отраслях промышленности)

«FORSTAR» (основан в 1998 г.)

ВЧ соединители, коаксиальные кабели,
кабельные сборки и микроволновые компоненты:

(Применяются в телекоммуникациях гражданского и специального назначения, в средствах связи, РЛС, а так же военной, авиационной и аэрокосмической отраслях промышленности).



Телефон: 8 (812) 309-75-97 (многоканальный)

Факс: 8 (812) 320-03-32

Электронная почта: ocean@oceanchips.ru

Web: <http://oceanchips.ru/>

Адрес: 198099, г. Санкт-Петербург, ул. Калинина, д. 2, корп. 4, лит. А