

## 3A High-Speed MOSFET Drivers

### Features

- Latch-Up Protected: Will Withstand 500 mA Reverse Current
- Input Will Withstand Negative Inputs Up to 5V
- ESD Protected: 4 kV
- High Peak Output Current: 3A
- Wide Input Supply Voltage Operating Range:
  - 4.5V to 16V
- High Capacitive Load Drive Capability:
  - 1800 pF in 20 nsec
- Short Delay Time: 35 nsec Typ
- Matched Delay Times
- Low Supply Current
  - With Logic '1' Input: 500  $\mu$ A
  - With Logic '0' Input: 100  $\mu$ A
- Low Output Impedance: 2.7 $\Omega$
- Available in Space-Saving 8-pin MSOP Package
- Pinout Same as TC1410/TC1411/TC1412

### General Description

The TC1413/TC1413N are 3A CMOS buffers/drivers. They will not latch-up under any conditions within their power and voltage ratings. They are not subject to damage when up to 5V of noise spiking of either polarity occurs on the ground pin. They can accept, without damage or logic upset, up to 500 mA of current of either polarity being forced back into their output. All terminals are fully protected against up to 4 kV of electrostatic discharge.

As MOSFET drivers, the TC1413/TC1413N can easily charge an 1800 pF gate capacitance in 20 nsec with matched rise and fall times, and provide low enough impedance in both the ON and the OFF states to ensure the MOSFET's intended state will not be affected, even by large transients. The leading and trailing edge propagation delay times are also matched to allow driving short-duration inputs with greater accuracy.

### Applications

- Switch Mode Power Supplies
- Line Drivers
- Pulse Transformer Drive
- Relay Driver

### Package Type



# TC1413/TC1413N

## Functional Block Diagram



## 1.0 ELECTRICAL CHARACTERISTICS

### Absolute Maximum Ratings†

Supply Voltage .....	+20V
Input Voltage .....	$V_{DD} + 0.3V$ to GND – 5.0V
Power Dissipation ( $T_A \leq 70^\circ\text{C}$ )	
MSOP .....	340 mW
PDIP .....	730 mW
SOIC.....	470 mW
Storage Temperature Range.....	-65°C to +150°C
Maximum Junction Temperature.....	+150°C

† Stresses above those listed under "Absolute Maximum Ratings" may cause permanent damage to the device. These are stress ratings only and functional operation of the device at these or any other conditions above those indicated in the operation sections of the specifications is not implied. Exposure to Absolute Maximum Rating conditions for extended periods may affect device reliability.

### PIN FUNCTION TABLE

Symbol	Description
$V_{DD}$	Supply input, 4.5V to 16V
INPUT	Control input
NC	No connection
GND	Ground
GND	Ground
OUTPUT	CMOS push-pull output, common to pin 7
OUTPUT	CMOS push-pull output, common to pin 6
$V_{DD}$	Supply input, 4.5V to 16V

## DC ELECTRICAL CHARACTERISTICS

**Electrical Specifications:** Unless otherwise noted, over operating temperature range with  $4.5V \leq V_{DD} \leq 16V$ . Typical values are measured at  $T_A = +25^\circ\text{C}$ ,  $V_{DD} = 16V$ .

Parameters	Sym	Min	Typ	Max	Units	Conditions
<b>Input</b>						
Logic '1', High Input Voltage	$V_{IH}$	2.0	—	—	V	
Logic '0', Low Input Voltage	$V_{IL}$	—	—	0.8	V	
Input Current	$I_{IN}$	-1.0 -10	— —	1.0 10	$\mu\text{A}$	$0V \leq V_{IN} \leq V_{DD}$ , $T_A = +25^\circ\text{C}$ $-40^\circ\text{C} \leq T_A \leq +85^\circ\text{C}$
<b>Output</b>						
High Output Voltage	$V_{OH}$	$V_{DD} - 0.025$	—	—	V	DC Test
Low Output Voltage	$V_{OL}$	—	—	0.025	V	DC Test
Output Resistance	$R_O$	—	2.7 3.3 3.3	4.0 5.0 5.0	$\Omega$	$V_{DD} = 16V$ , $I_O = 10\text{ mA}$ , $T_A = +25^\circ\text{C}$ $0^\circ\text{C} \leq T_A \leq +70^\circ\text{C}$ $-40^\circ\text{C} \leq T_A \leq +85^\circ\text{C}$
Peak Output Current	$I_{PK}$	—	3.0	—	A	$V_{DD} = 16V$
Latch-Up Protection Withstand Reverse Current	$I_{REV}$	—	0.5	—	A	Duty cycle $\leq 2\%$ , $t \leq 300\ \mu\text{sec}$ , $V_{DD} = 16V$
<b>Switching Time (Note 1)</b>						
Rise Time	$t_R$	—	20 22 24	28 33 33	nsec	$T_A = +25^\circ\text{C}$ $0^\circ\text{C} \leq T_A \leq +70^\circ\text{C}$ $-40^\circ\text{C} \leq T_A \leq +85^\circ\text{C}$ , <b>Figure 4-1</b>
Fall Time	$t_F$	—	20 22 24	28 33 33	nsec	$T_A = +25^\circ\text{C}$ $0^\circ\text{C} \leq T_A \leq +70^\circ\text{C}$ $-40^\circ\text{C} \leq T_A \leq +85^\circ\text{C}$ , <b>Figure 4-1</b>

**Note 1:** Switching times ensured by design.

# TC1413/TC1413N

## DC ELECTRICAL CHARACTERISTICS (CONTINUED)

**Electrical Specifications:** Unless otherwise noted, over operating temperature range with  $4.5V \leq V_{DD} \leq 16V$ . Typical values are measured at  $T_A = +25^\circ C$ ,  $V_{DD} = 16V$ .

Parameters	Sym	Min	Typ	Max	Units	Conditions
Delay Time	$t_{D1}$	—	35	45	nsec	$T_A = +25^\circ C$ , $0^\circ C \leq T_A \leq +70^\circ C$ $-40^\circ C \leq T_A \leq +85^\circ C$ , <b>Figure 4-1</b>
		—	40	50		
		—	40	50		
Delay Time	$t_{D2}$	—	35	45	nsec	$T_A = +25^\circ C$ $0^\circ C \leq T_A \leq +70^\circ C$ $-40^\circ C \leq T_A \leq +85^\circ C$ , <b>Figure 4-1</b>
		—	40	50		
		—	40	50		
<b>Power Supply</b>						
Power Supply Current	$I_S$	—	0.5	1.0	mA	$V_{IN} = 3V$ , $V_{DD} = 16V$ $V_{IN} = 0V$
		—	0.1	0.15		

**Note 1:** Switching times ensured by design.

## TEMPERATURE CHARACTERISTICS

**Electrical Specifications:** Unless otherwise noted, all parameters apply with  $4.5V \leq V_{DD} \leq 18V$ .

Parameters	Sym	Min	Typ	Max	Units	Conditions
<b>Temperature Ranges</b>						
Specified Temperature Range (C)	$T_A$	0	—	+70	$^\circ C$	
Specified Temperature Range (E)	$T_A$	-40	—	+85	$^\circ C$	
Maximum Junction Temperature	$T_J$	—	—	+150	$^\circ C$	
Storage Temperature Range	$T_A$	-65	—	+150	$^\circ C$	
<b>Package Thermal Resistances</b>						
Thermal Resistance, 8L-MSOP	$\theta_{JA}$	—	206	—	$^\circ C/W$	
Thermal Resistance, 8L-PDIP	$\theta_{JA}$	—	125	—	$^\circ C/W$	
Thermal Resistance, 8L-SOIC	$\theta_{JA}$	—	155	—	$^\circ C/W$	

## 2.0 TYPICAL PERFORMANCE CURVES

**Note:** The graphs and tables provided following this note are a statistical summary based on a limited number of samples and are provided for informational purposes only. The performance characteristics listed herein are not tested or guaranteed. In some graphs or tables, the data presented may be outside the specified operating range (e.g., outside specified power supply range) and therefore outside the warranted range.

**Note:** Unless otherwise indicated, over operating temperature range with  $4.5V \leq V_{DD} \leq 16V$ .



**FIGURE 2-1:** Quiescent Supply Current vs. Supply Voltage.

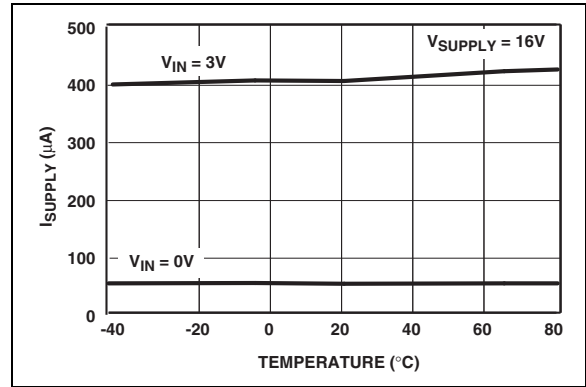

**FIGURE 2-4:** Quiescent Supply Current vs. Temperature.



**FIGURE 2-2:** Input Threshold vs. Supply Voltage.

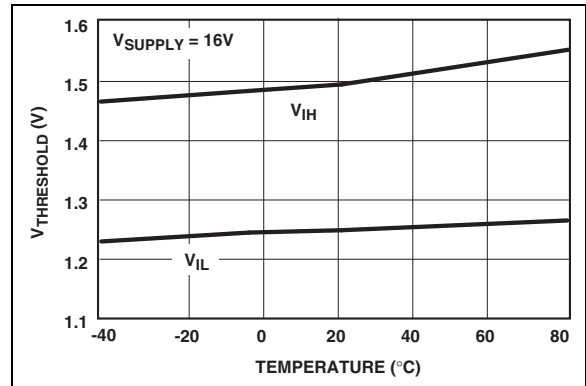

**FIGURE 2-5:** Input Threshold vs. Temperature.

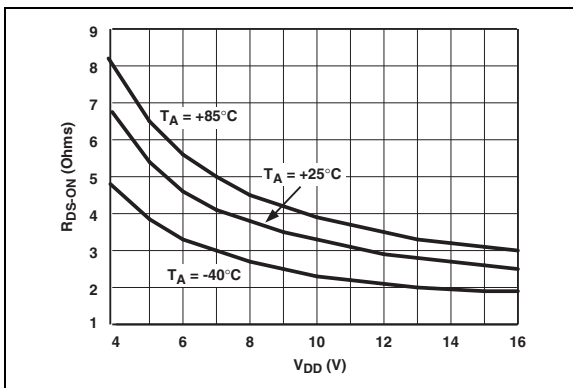

**FIGURE 2-3:** High-State Output Resistance vs. Supply Voltage

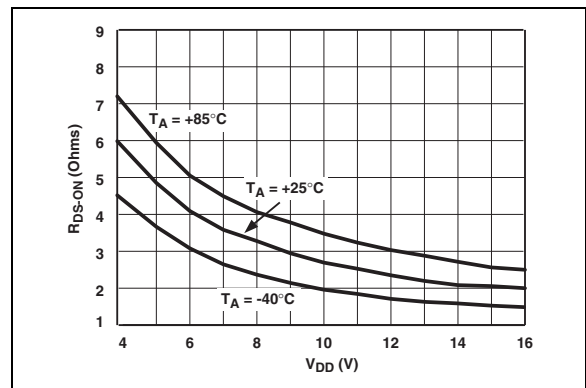

**FIGURE 2-6:** Low-State Output Resistance vs. Supply Voltage

# TC1413/TC1413N

**Note:** Unless otherwise indicated, over operating temperature range with  $4.5V \leq V_{DD} \leq 16V$ .



**FIGURE 2-7:** Rise Time vs. Supply Voltage.



**FIGURE 2-10:** Fall Time vs. Supply Voltage.



**FIGURE 2-8:** Propagation Delay vs. Supply Voltage.



**FIGURE 2-11:** Propagation Delay vs. Supply Voltage.



**FIGURE 2-9:** Rise and Fall Times vs. Capacitive Load.



**FIGURE 2-12:** Propagation Delays vs. Capacitive Load.

## 3.0 PIN DESCRIPTIONS

The descriptions of the pins are listed in Table 3-1.

**TABLE 3-1: PIN FUNCTION TABLE**

Pin No.	Symbol	Description
1	V <sub>DD</sub>	Supply input, 4.5V to 16V
2	INPUT	Control input
3	NC	No connection
4	GND	Ground
5	GND	Ground
6	OUTPUT	CMOS push-pull output, common to pin 7
7	OUTPUT	CMOS push-pull output, common to pin 6
8	V <sub>DD</sub>	Supply input, 4.5V to 16V

### 3.1 Supply Input (V<sub>DD</sub>)

The V<sub>DD</sub> input is the bias supply for the MOSFET driver and is rated for 4.5V to 16V with respect to the ground pin. The V<sub>DD</sub> input should be bypassed to ground with a local ceramic capacitor. The value of the capacitor should be chosen based on the capacitive load that is being driven. A value of 1.0  $\mu$ F is suggested.

### 3.2 Control Input (INPUT)

The MOSFET driver input is a high-impedance, TTL/CMOS-compatible input. The input has 300 mV of hysteresis between the high and low thresholds which prevents output glitching even when the rise and fall time of the input signal is very slow.

### 3.3 CMOS Push-Pull Output (OUTPUT)

The MOSFET driver output is a low-impedance, CMOS push-pull style output, capable of driving a capacitive load with 3A peak currents.

### 3.4 Ground (GND)

The ground pins are the return path for the bias current and for the high peak currents that discharge the load capacitor. The ground pins should be tied into a ground plane or have very short traces to the bias supply source return.

### 3.5 No Connect (NC)

No internal connection.

# TC1413/TC1413N

## 4.0 APPLICATION INFORMATION



**FIGURE 4-1:** Switching Time Test Circuit.



## 5.0 PACKAGING INFORMATION

### 5.1 Package Marking Information

8-Lead PDIP (300 mil)



Example:

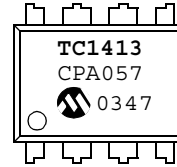

8-Lead SOIC (150 mil)



Example:

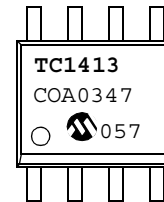

8-Lead MSOP

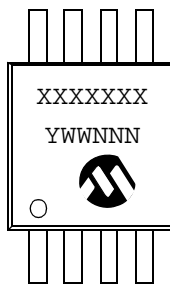

Example:



<b>Legend:</b>	XX...X	Customer-specific information
	Y	Year code (last digit of calendar year)
	YY	Year code (last 2 digits of calendar year)
	WW	Week code (week of January 1 is week '01')
	NNN	Alphanumeric traceability code
	(e3)	Pb-free JEDEC designator for Matte Tin (Sn)
	*	This package is Pb-free. The Pb-free JEDEC designator (e3) can be found on the outer packaging for this package.

**Note:** In the event the full Microchip part number cannot be marked on one line, it will be carried over to the next line, thus limiting the number of available characters for customer-specific information.

# TC1413/TC1413N

## 8-Lead Plastic Dual In-line (PA) – 300 mil (PDIP)

**Note:** For the most current package drawings, please see the Microchip Packaging Specification located at <http://www.microchip.com/packaging>



Units		INCHES*			MILLIMETERS		
Dimension Limits		MIN	NOM	MAX	MIN	NOM	MAX
Number of Pins	n		8			8	
Pitch	p		.100			2.54	
Top to Seating Plane	A	.140	.155	.170	3.56	3.94	4.32
Molded Package Thickness	A2	.115	.130	.145	2.92	3.30	3.68
Base to Seating Plane	A1	.015			0.38		
Shoulder to Shoulder Width	E	.300	.313	.325	7.62	7.94	8.26
Molded Package Width	E1	.240	.250	.260	6.10	6.35	6.60
Overall Length	D	.360	.373	.385	9.14	9.46	9.78
Tip to Seating Plane	L	.125	.130	.135	3.18	3.30	3.43
Lead Thickness	c	.008	.012	.015	0.20	0.29	0.38
Upper Lead Width	B1	.045	.058	.070	1.14	1.46	1.78
Lower Lead Width	B	.014	.018	.022	0.36	0.46	0.56
Overall Row Spacing	§ eB	.310	.370	.430	7.87	9.40	10.92
Mold Draft Angle Top	α	5	10	15	5	10	15
Mold Draft Angle Bottom	β	5	10	15	5	10	15

\* Controlling Parameter

§ Significant Characteristic

Notes:

Dimensions D and E1 do not include mold flash or protrusions. Mold flash or protrusions shall not exceed .010" (0.254mm) per side.

JEDEC Equivalent: MS-001

Drawing No. C04-018

# TC1413/TC1413N

## 8-Lead Plastic Small Outline (OA) – Narrow, 150 mil (SOIC)

**Note:** For the most current package drawings, please see the Microchip Packaging Specification located at <http://www.microchip.com/packaging>



Dimension	Units	INCHES*			MILLIMETERS		
		MIN	NOM	MAX	MIN	NOM	MAX
Number of Pins	n		8			8	
Pitch	p		.050			1.27	
Overall Height	A	.053	.061	.069	1.35	1.55	1.75
Molded Package Thickness	A2	.052	.056	.061	1.32	1.42	1.55
Standoff §	A1	.004	.007	.010	0.10	0.18	0.25
Overall Width	E	.228	.237	.244	5.79	6.02	6.20
Molded Package Width	E1	.146	.154	.157	3.71	3.91	3.99
Overall Length	D	.189	.193	.197	4.80	4.90	5.00
Chamfer Distance	h	.010	.015	.020	0.25	0.38	0.51
Foot Length	L	.019	.025	.030	0.48	0.62	0.76
Foot Angle	φ	0	4	8	0	4	8
Lead Thickness	c	.008	.009	.010	0.20	0.23	0.25
Lead Width	B	.013	.017	.020	0.33	0.42	0.51
Mold Draft Angle Top	α	0	12	15	0	12	15
Mold Draft Angle Bottom	β	0	12	15	0	12	15

\* Controlling Parameter  
 § Significant Characteristic

Notes:  
 Dimensions D and E1 do not include mold flash or protrusions. Mold flash or protrusions shall not exceed .010" (0.254mm) per side.  
 JEDEC Equivalent: MS-012  
 Drawing No. C04-057

# TC1413/TC1413N

## 8-Lead Plastic Micro Small Outline Package (UA) (MSOP)

**Note:** For the most current package drawings, please see the Microchip Packaging Specification located at <http://www.microchip.com/packaging>

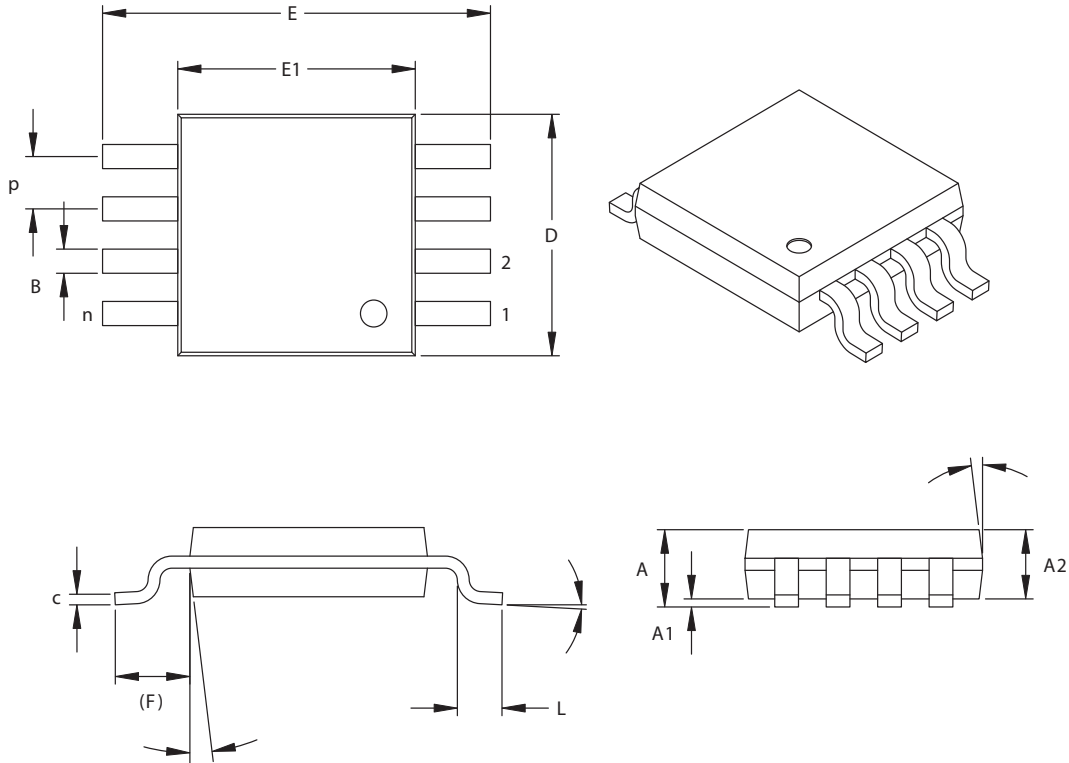

Units		INCHES			MILLIMETERS*		
Dimension Limits		MIN	NOM	MAX	MIN	NOM	MAX
Number of Pins	n		8			8	
Pitch	P	.026 BSC			0.65 BSC		
Overall Height	A	-	-	.043	-	-	1.10
Molded Package Thickness	A2	.030	.033	.037	0.75	0.85	0.95
Standoff	A1	.000	-	.006	0.00	-	0.15
Overall Width	E	.193 BSC			4.90 BSC		
Molded Package Width	E1	.118 BSC			3.00 BSC		
Overall Length	D	.118 BSC			3.00 BSC		
Foot Length	L	.016	.024	.031	0.40	0.60	0.80
Footprint (Reference)	F	.037 REF			0.95 REF		
Foot Angle		0°	-	8°	0°	-	8°
Lead Thickness	c	.003	.006	.009	0.08	-	0.23
Lead Width	B	.009	.012	.016	0.22	-	0.40
Mold Draft Angle Top		5°	-	15°	5°	-	15°
Mold Draft Angle Bottom		5°	-	15°	5°	-	15°

\*Controlling Parameter

Notes:

Dimensions D and E1 do not include mold flash or protrusions. Mold flash or protrusions shall not exceed .010" (0.254mm) per side.

JEDEC Equivalent: MO-187

Drawing No. C04-111

## 6.0 REVISION HISTORY

### Revision D (December 2012)

Added a note to each package outline drawing.

# TC1413/TC1413N

---

NOTES:

## PRODUCT IDENTIFICATION SYSTEM

To order or obtain information, e.g., on pricing or delivery, refer to the factory or the listed sales office.

<u>PART NO.</u>	<u>X</u>	<u>/XX</u>
Device	Temperature Range	Package
Device:	TC1413: 3 A Single MOSFET Driver, Inverting TC1413N: 3 A Single MOSFET Driver, Non-Inverting	
Temperature Range:	C = 0°C to +70°C E = -40°C to +85°C	
Package:	OA = Plastic SOIC, (150 mil Body), 8-lead OA713 = Plastic SOIC, (150 mil Body), 8-lead (Tape and Reel) UA = Plastic Micro Small Outline (MSOP), 8-lead * UA713 = Plastic Micro Small Outline (MSOP), 8-lead * (Tape and Reel) PA = Plastic DIP (300 mil Body), 8-lead * MSOP package is only available in E-Temp.	

**Examples:**

- a) TC1413COA: 3A Single MOSFET driver, SOIC package, 0°C to +70°C.
- b) TC1413CPA: 3A Single MOSFET driver, PDIP package, 0°C to +70°C.
- c) TC1413EUA713: Tape and Reel, 3A Single MOSFET driver, MSOP package, -40°C to +85°C.

- a) TC1413NCPA: 3A Single MOSFET driver, PDIP package, 0°C to +70°C.
- b) TC1413NEPA: 3A Single MOSFET driver, PDIP package, -40°C to +85°C.
- c) TC1413NEUA: 3A Single MOSFET driver, MSOP package, -40°C to +85°C.

## Sales and Support

### Data Sheets

Products supported by a preliminary Data Sheet may have an errata sheet describing minor operational differences and recommended workarounds. To determine if an errata sheet exists for a particular device, please contact one of the following:

1. Your local Microchip sales office
2. The Microchip Worldwide Site ([www.microchip.com](http://www.microchip.com))

Please specify which device, revision of silicon and Data Sheet (include Literature #) you are using.

### Customer Notification System

Register on our web site ([www.microchip.com/cn](http://www.microchip.com/cn)) to receive the most current information on our products.

# TC1413/TC1413N

---

NOTES:



---

**Note the following details of the code protection feature on Microchip devices:**

- Microchip products meet the specification contained in their particular Microchip Data Sheet.
- Microchip believes that its family of products is one of the most secure families of its kind on the market today, when used in the intended manner and under normal conditions.
- There are dishonest and possibly illegal methods used to breach the code protection feature. All of these methods, to our knowledge, require using the Microchip products in a manner outside the operating specifications contained in Microchip's Data Sheets. Most likely, the person doing so is engaged in theft of intellectual property.
- Microchip is willing to work with the customer who is concerned about the integrity of their code.
- Neither Microchip nor any other semiconductor manufacturer can guarantee the security of their code. Code protection does not mean that we are guaranteeing the product as “unbreakable.”

Code protection is constantly evolving. We at Microchip are committed to continuously improving the code protection features of our products. Attempts to break Microchip's code protection feature may be a violation of the Digital Millennium Copyright Act. If such acts allow unauthorized access to your software or other copyrighted work, you may have a right to sue for relief under that Act.

---

Information contained in this publication regarding device applications and the like is provided only for your convenience and may be superseded by updates. It is your responsibility to ensure that your application meets with your specifications. MICROCHIP MAKES NO REPRESENTATIONS OR WARRANTIES OF ANY KIND WHETHER EXPRESS OR IMPLIED, WRITTEN OR ORAL, STATUTORY OR OTHERWISE, RELATED TO THE INFORMATION, INCLUDING BUT NOT LIMITED TO ITS CONDITION, QUALITY, PERFORMANCE, MERCHANTABILITY OR FITNESS FOR PURPOSE. Microchip disclaims all liability arising from this information and its use. Use of Microchip devices in life support and/or safety applications is entirely at the buyer's risk, and the buyer agrees to defend, indemnify and hold harmless Microchip from any and all damages, claims, suits, or expenses resulting from such use. No licenses are conveyed, implicitly or otherwise, under any Microchip intellectual property rights.

#### **Trademarks**

The Microchip name and logo, the Microchip logo, dsPIC, FlashFlex, KEELOQ, KEELOQ logo, MPLAB, PIC, PICmicro, PICSTART, PIC<sup>32</sup> logo, rPIC, SST, SST Logo, SuperFlash and UNI/O are registered trademarks of Microchip Technology Incorporated in the U.S.A. and other countries.

FilterLab, Hampshire, HI-TECH C, Linear Active Thermistor, MTP, SEEVAL and The Embedded Control Solutions Company are registered trademarks of Microchip Technology Incorporated in the U.S.A.

Silicon Storage Technology is a registered trademark of Microchip Technology Inc. in other countries.

Analog-for-the-Digital Age, Application Maestro, BodyCom, chipKIT, chipKIT logo, CodeGuard, dsPICDEM, dsPICDEM.net, dsPICworks, dsSPEAK, ECAN, ECONOMONITOR, FanSense, HI-TIDE, In-Circuit Serial Programming, ICSP, Mindi, MiWi, MPASM, MPF, MPLAB Certified logo, MPLIB, MPLINK, mTouch, Omniclient Code Generation, PICC, PICC-18, PICDEM, PICDEM.net, PICkit, PICtail, REAL ICE, rLAB, Select Mode, SQI, Serial Quad I/O, Total Endurance, TSHARC, UniWinDriver, WiperLock, ZENA and Z-Scale are trademarks of Microchip Technology Incorporated in the U.S.A. and other countries.

SQTP is a service mark of Microchip Technology Incorporated in the U.S.A.

GestIC and ULPP are registered trademarks of Microchip Technology Germany II GmbH & Co. & KG, a subsidiary of Microchip Technology Inc., in other countries.

All other trademarks mentioned herein are property of their respective companies.

© 2001-2012, Microchip Technology Incorporated, Printed in the U.S.A., All Rights Reserved.

 Printed on recycled paper.

ISBN: 9781620767870

*Microchip received ISO/TS-16949:2009 certification for its worldwide headquarters, design and wafer fabrication facilities in Chandler and Tempe, Arizona; Gresham, Oregon and design centers in California and India. The Company's quality system processes and procedures are for its PIC<sup>®</sup> MCUs and dsPIC<sup>®</sup> DSCs, KEELOQ<sup>®</sup> code hopping devices, Serial EEPROMs, microperipherals, nonvolatile memory and analog products. In addition, Microchip's quality system for the design and manufacture of development systems is ISO 9001:2000 certified.*

---

**QUALITY MANAGEMENT SYSTEM**  
**CERTIFIED BY DNV**  
**== ISO/TS 16949 ==**



# MICROCHIP

## Worldwide Sales and Service

### AMERICAS

**Corporate Office**  
2355 West Chandler Blvd.  
Chandler, AZ 85224-6199  
Tel: 480-792-7200  
Fax: 480-792-7277  
Technical Support:  
<http://www.microchip.com/support>  
Web Address:  
[www.microchip.com](http://www.microchip.com)

**Atlanta**  
Duluth, GA  
Tel: 678-957-9614  
Fax: 678-957-1455

**Boston**  
Westborough, MA  
Tel: 774-760-0087  
Fax: 774-760-0088

**Chicago**  
Itasca, IL  
Tel: 630-285-0071  
Fax: 630-285-0075

**Cleveland**  
Independence, OH  
Tel: 216-447-0464  
Fax: 216-447-0643

**Dallas**  
Addison, TX  
Tel: 972-818-7423  
Fax: 972-818-2924

**Detroit**  
Farmington Hills, MI  
Tel: 248-538-2250  
Fax: 248-538-2260

**Indianapolis**  
Noblesville, IN  
Tel: 317-773-8323  
Fax: 317-773-5453

**Los Angeles**  
Mission Viejo, CA  
Tel: 949-462-9523  
Fax: 949-462-9608

**Santa Clara**  
Santa Clara, CA  
Tel: 408-961-6444  
Fax: 408-961-6445

**Toronto**  
Mississauga, Ontario,  
Canada  
Tel: 905-673-0699  
Fax: 905-673-6509

### ASIA/PACIFIC

**Asia Pacific Office**  
Suites 3707-14, 37th Floor  
Tower 6, The Gateway  
Harbour City, Kowloon  
Hong Kong  
Tel: 852-2401-1200  
Fax: 852-2401-3431

**Australia - Sydney**  
Tel: 61-2-9868-6733  
Fax: 61-2-9868-6755

**China - Beijing**  
Tel: 86-10-8569-7000  
Fax: 86-10-8528-2104

**China - Chengdu**  
Tel: 86-28-8665-5511  
Fax: 86-28-8665-7889

**China - Chongqing**  
Tel: 86-23-8980-9588  
Fax: 86-23-8980-9500

**China - Hangzhou**  
Tel: 86-571-2819-3187  
Fax: 86-571-2819-3189

**China - Hong Kong SAR**  
Tel: 852-2943-5100  
Fax: 852-2401-3431

**China - Nanjing**  
Tel: 86-25-8473-2460  
Fax: 86-25-8473-2470

**China - Qingdao**  
Tel: 86-532-8502-7355  
Fax: 86-532-8502-7205

**China - Shanghai**  
Tel: 86-21-5407-5533  
Fax: 86-21-5407-5066

**China - Shenyang**  
Tel: 86-24-2334-2829  
Fax: 86-24-2334-2393

**China - Shenzhen**  
Tel: 86-755-8864-2200  
Fax: 86-755-8203-1760

**China - Wuhan**  
Tel: 86-27-5980-5300  
Fax: 86-27-5980-5118

**China - Xian**  
Tel: 86-29-8833-7252  
Fax: 86-29-8833-7256

**China - Xiamen**  
Tel: 86-592-2388138  
Fax: 86-592-2388130

**China - Zhuhai**  
Tel: 86-756-3210040  
Fax: 86-756-3210049

### ASIA/PACIFIC

**India - Bangalore**  
Tel: 91-80-3090-4444  
Fax: 91-80-3090-4123

**India - New Delhi**  
Tel: 91-11-4160-8631  
Fax: 91-11-4160-8632

**India - Pune**  
Tel: 91-20-2566-1512  
Fax: 91-20-2566-1513

**Japan - Osaka**  
Tel: 81-66-152-7160  
Fax: 81-66-152-9310

**Japan - Yokohama**  
Tel: 81-45-471-6166  
Fax: 81-45-471-6122

**Korea - Daegu**  
Tel: 82-53-744-4301  
Fax: 82-53-744-4302

**Korea - Seoul**  
Tel: 82-2-554-7200  
Fax: 82-2-558-5932 or  
82-2-558-5934

**Malaysia - Kuala Lumpur**  
Tel: 60-3-6201-9857  
Fax: 60-3-6201-9859

**Malaysia - Penang**  
Tel: 60-4-227-8870  
Fax: 60-4-227-4068

**Philippines - Manila**  
Tel: 63-2-634-9065  
Fax: 63-2-634-9069

**Singapore**  
Tel: 65-6334-8870  
Fax: 65-6334-8850

**Taiwan - Hsin Chu**  
Tel: 886-3-5778-366  
Fax: 886-3-5770-955

**Taiwan - Kaohsiung**  
Tel: 886-7-213-7828  
Fax: 886-7-330-9305

**Taiwan - Taipei**  
Tel: 886-2-2508-8600  
Fax: 886-2-2508-0102

**Thailand - Bangkok**  
Tel: 66-2-694-1351  
Fax: 66-2-694-1350

### EUROPE

**Austria - Wels**  
Tel: 43-7242-2244-39  
Fax: 43-7242-2244-393

**Denmark - Copenhagen**  
Tel: 45-4450-2828  
Fax: 45-4485-2829

**France - Paris**  
Tel: 33-1-69-53-63-20  
Fax: 33-1-69-30-90-79

**Germany - Munich**  
Tel: 49-89-627-144-0  
Fax: 49-89-627-144-44

**Italy - Milan**  
Tel: 39-0331-742611  
Fax: 39-0331-466781

**Netherlands - Drunen**  
Tel: 31-416-690399  
Fax: 31-416-690340

**Spain - Madrid**  
Tel: 34-91-708-08-90  
Fax: 34-91-708-08-91

**UK - Wokingham**  
Tel: 44-118-921-5869  
Fax: 44-118-921-5820

11/27/12

Компания «Океан Электроники» предлагает заключение долгосрочных отношений при поставках импортных электронных компонентов на взаимовыгодных условиях!

Наши преимущества:

- Поставка оригинальных импортных электронных компонентов напрямую с производств Америки, Европы и Азии, а так же с крупнейших складов мира;
- Широкая линейка поставок активных и пассивных импортных электронных компонентов (более 30 млн. наименований);
- Поставка сложных, дефицитных, либо снятых с производства позиций;
- Оперативные сроки поставки под заказ (от 5 рабочих дней);
- Экспресс доставка в любую точку России;
- Помощь Конструкторского Отдела и консультации квалифицированных инженеров;
- Техническая поддержка проекта, помощь в подборе аналогов, поставка прототипов;
- Поставка электронных компонентов под контролем ВП;
- Система менеджмента качества сертифицирована по Международному стандарту ISO 9001;
- При необходимости вся продукция военного и аэрокосмического назначения проходит испытания и сертификацию в лаборатории (по согласованию с заказчиком);
- Поставка специализированных компонентов военного и аэрокосмического уровня качества (Xilinx, Altera, Analog Devices, Intersil, Interpoint, Microsemi, Actel, Aeroflex, Peregrine, VPT, Syfer, Eurofarad, Texas Instruments, MS Kennedy, Miteq, Cobham, E2V, MA-COM, Hittite, Mini-Circuits, General Dynamics и др.);

Компания «Океан Электроники» является официальным дистрибьютором и эксклюзивным представителем в России одного из крупнейших производителей разъемов военного и аэрокосмического назначения «JONHON», а так же официальным дистрибьютором и эксклюзивным представителем в России производителя высокотехнологичных и надежных решений для передачи СВЧ сигналов «FORSTAR».



## JONHON

«JONHON» (основан в 1970 г.)

Разъемы специального, военного и аэрокосмического назначения:

(Применяются в военной, авиационной, аэрокосмической, морской, железнодорожной, горно- и нефтедобывающей отраслях промышленности)

«FORSTAR» (основан в 1998 г.)

ВЧ соединители, коаксиальные кабели, кабельные сборки и микроволновые компоненты:

(Применяются в телекоммуникациях гражданского и специального назначения, в средствах связи, РЛС, а так же военной, авиационной и аэрокосмической отраслях промышленности).



Телефон: 8 (812) 309-75-97 (многоканальный)

Факс: 8 (812) 320-03-32

Электронная почта: [ocean@oceanchips.ru](mailto:ocean@oceanchips.ru)

Web: <http://oceanchips.ru/>

Адрес: 198099, г. Санкт-Петербург, ул. Калинина, д. 2, корп. 4, лит. А