



Film Capacitors

Metallized Polypropylene Film Capacitors (MKP)

Series/Type: B32656S, B32658S

Date: June 2018

© EPCOS AG 2018. Reproduction, publication and dissemination of this publication, enclosures hereto and the information contained therein without EPCOS' prior express consent is prohibited.

EPCOS AG is a TDK Group Company.

Snubber (wound)**Typical applications**

- IGBT
- Snubbing

Climatic

- Max. operating temperature: 110 °C
- Climatic category (IEC 60068-1:2013): 55/100/56

Construction

- Dielectric: polypropylene (PP)
- Wound capacitor technology with internal series connection
- Plastic case (UL 94 V-0)
- Epoxy resin sealing (UL 94 V-0)

Features

- High pulse strength and high contact reliability
- Very low inductance
- RoHS-compatible
- AEC-Q200D compliant

Terminals

- Strap terminals, tinned copper or brass (max. torque 10 Nm)

Marking

Manufacturer's logo, ordering code, style (MKP)
rated capacitance (coded), cap. tolerance (code letter),
rated DC voltage, date of manufacture (coded)

Delivery mode

Bulk (untaped)

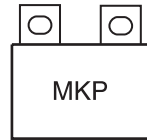

Dimensional drawings

T1 (code no. 561)

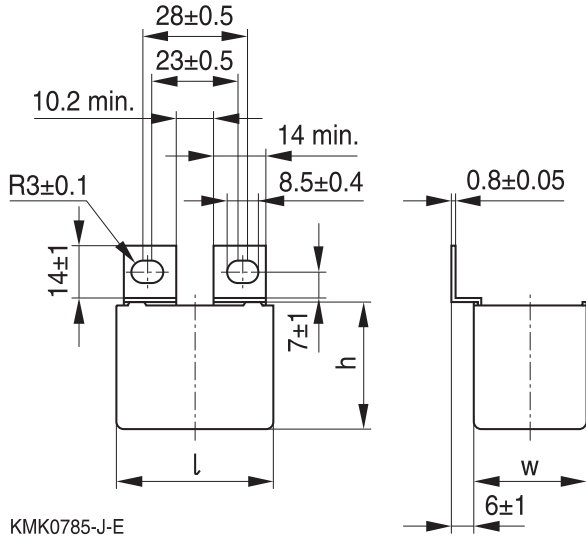

T2 (code no. 562)

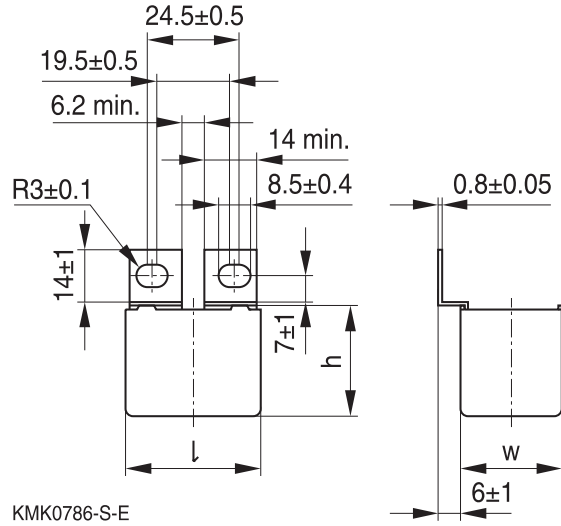

T3 (code no. 563)

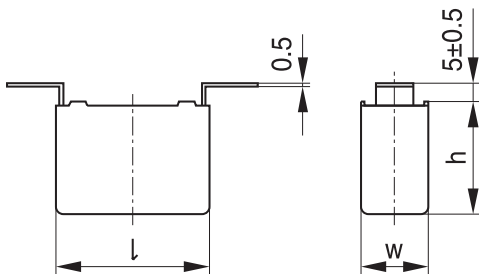

T4 (code no. 564)

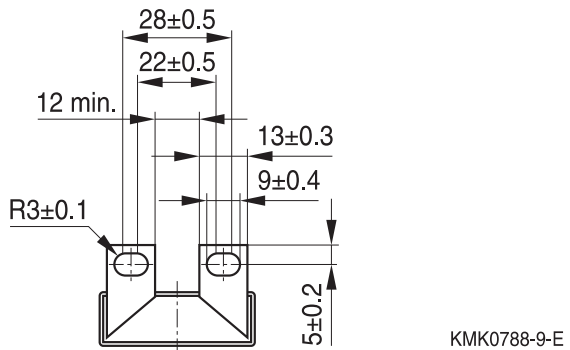
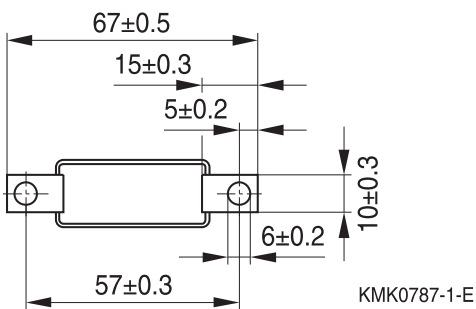
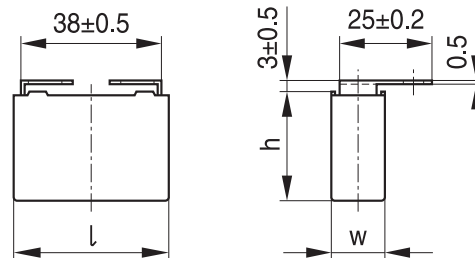



B32656S, B32658S

Snubber (wound)

Dimensional drawings

T5 (code no. 565)

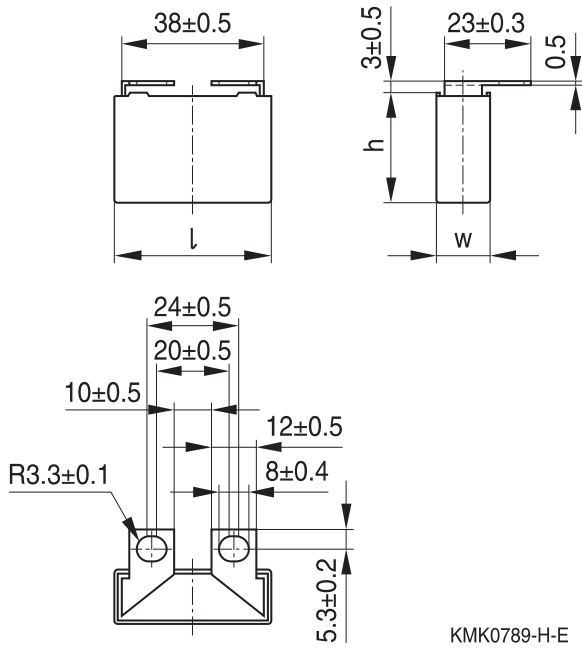

T6 (code no. 566)

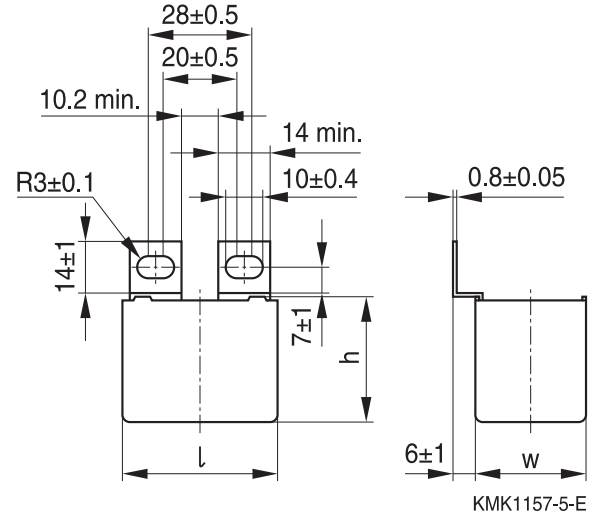

T7 (code no. 577)

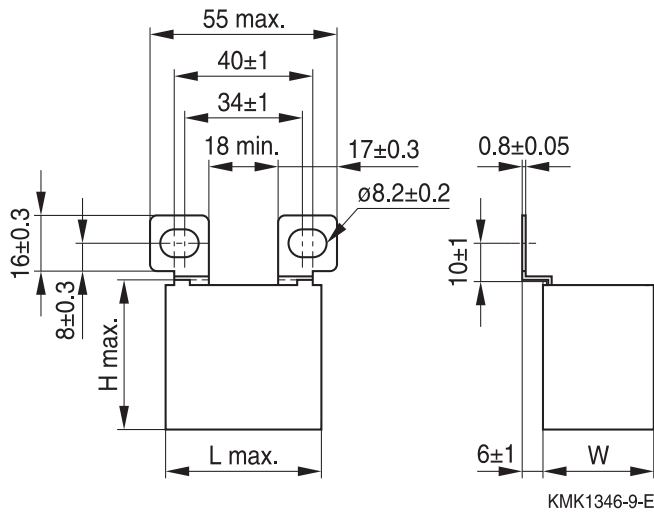

T8 (code no. 408)

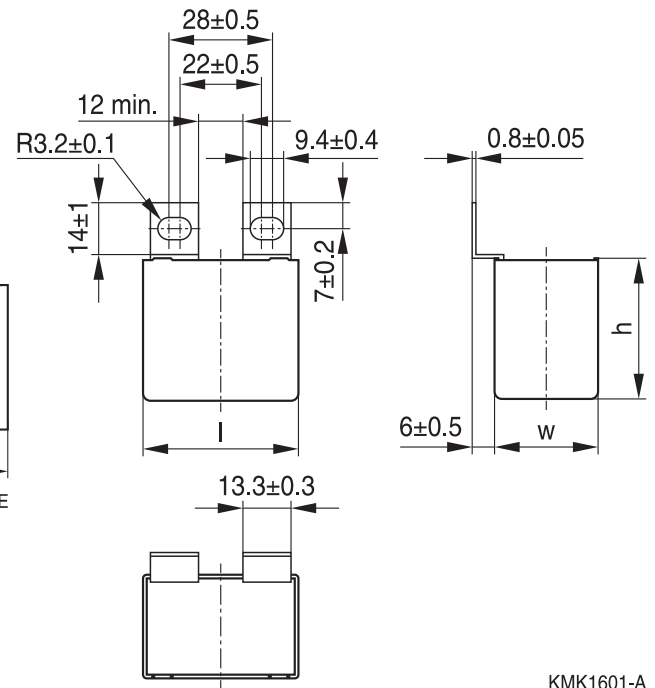

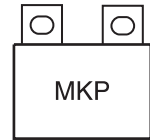

Dimensional drawings

T9 (code no. 409)

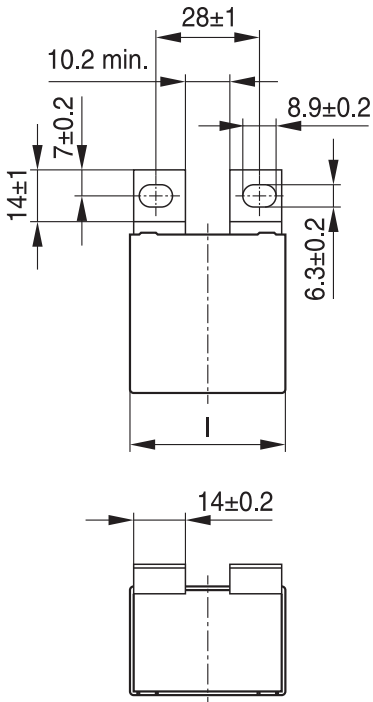

T10 (code no. 410)



KMK1602-B

KMK1603-C

T11 (code no. 411)



T12 (code no. 412)

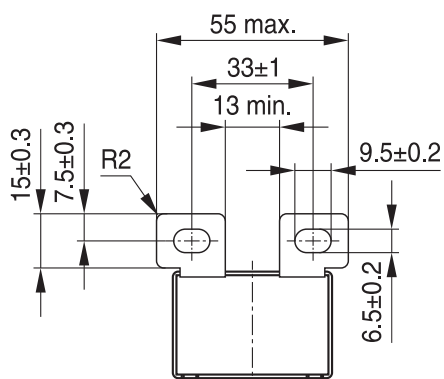
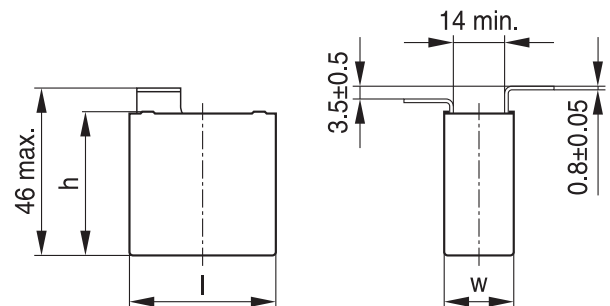

KMK1604-D

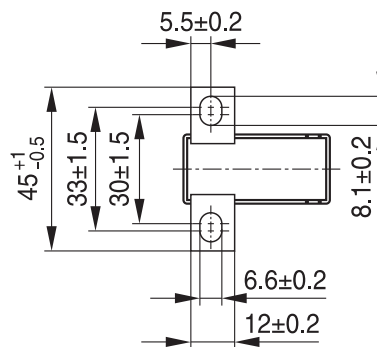

KMK1605-E

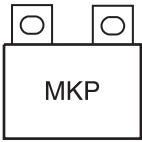

B32656S, B32658S

Snubber (wound)

Dimensional drawings

T14 (code no. 414)



KMK1607-G

T15 (code no. 415)

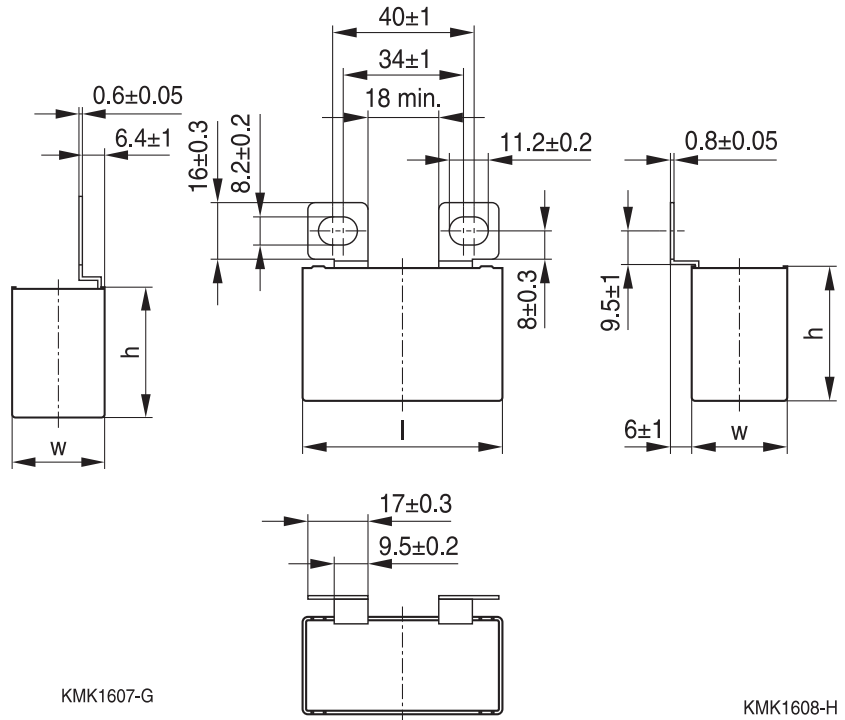

KMK1608-H

T16 (code no. 416)

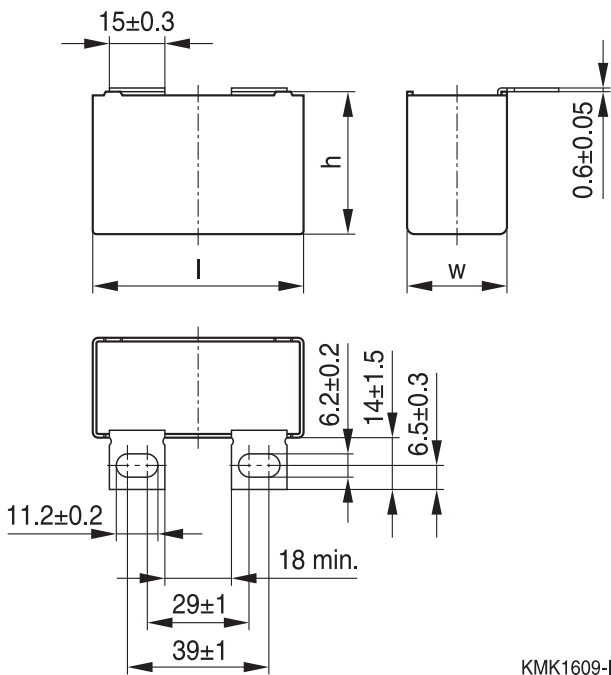

KMK1609-I

T17 (code no. 417)

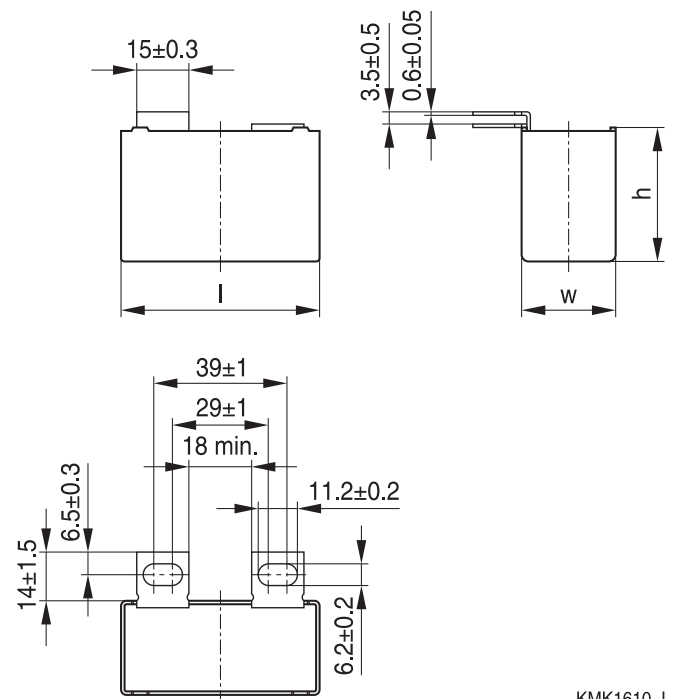

KMK1610-J

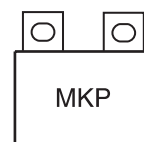

Dimensional drawings

T18 (code no. 418)



B32656S, B32658S
Snubber (wound)
Overview of available types

| Type | B32656S | | | | | B32658S | | | | |
|------------------|---------|------|------|------|------|---------|------|------|------|------|
| V_R (V DC) | 850 | 1000 | 1250 | 1700 | 2000 | 850 | 1000 | 1250 | 1700 | 2000 |
| V_{RMS} (V AC) | 450 | 480 | 500 | 750 | 800 | 450 | 480 | 500 | 750 | 800 |
| C_R (nF) | | | | | | | | | | |
| 68 | | | | | | | | | | |
| 100 | | | | | | | | | | |
| 120 | | | | | | | | | | |
| 150 | | | | | | | | | | |
| 220 | | | | | | | | | | |
| 270 | | | | | | | | | | |
| 330 | | | | | | | | | | |
| 390 | | | | | | | | | | |
| 470 | | | | | | | | | | |
| 560 | | | | | | | | | | |
| 680 | | | | | | | | | | |
| 820 | | | | | | | | | | |
| 900 | | | | | | | | | | |
| 1000 | | | | | | | | | | |
| 1200 | | | | | | | | | | |
| 1400 | | | | | | | | | | |
| 1500 | | | | | | | | | | |
| 1800 | | | | | | | | | | |
| 2200 | | | | | | | | | | |
| 2700 | | | | | | | | | | |
| 3000 | | | | | | | | | | |
| 3300 | | | | | | | | | | |
| 4000 | | | | | | | | | | |
| 4200 | | | | | | | | | | |
| 4500 | | | | | | | | | | |
| 4700 | | | | | | | | | | |
| 5000 | | | | | | | | | | |
| 5600 | | | | | | | | | | |

Ordering codes and packing units

| V_R | V_{RMS} $f \leq 1\text{kHz}$ | C_R | Max. dimensions $w \times h \times l$ | I_{RMS} 100 kHz | ESR_{typ} 100 kHz | Ordering code (composition see below) | Ter- minal | pcs./ MOQ | | |
|-------|-----------------------------------|-------|--|----------------------|------------------------|---|---------------|-----------------|-----|-----|
| V DC | V AC | nF | mm | A | m Ω | | | | | |
| 850 | 450 | 560 | 14.0 × 25.0 × 42.0 | 8.0 | 9.0 | B32656S8564+408 | T8 | 288 | | |
| | | 560 | 14.0 × 25.0 × 42.0 | 8.0 | 9.0 | B32656S8564+418 | T18 | 288 | | |
| | | 560 | 14.0 × 25.0 × 42.0 | 8.0 | 9.0 | B32656S8564+563 | T3 | 168 | | |
| | | 560 | 14.0 × 25.0 × 42.0 | 8.0 | 9.0 | B32656S8564+564 | T4 | 288 | | |
| | | 560 | 14.0 × 25.0 × 42.0 | 8.0 | 9.0 | B32656S8564+565 | T5 | 288 | | |
| | | 680 | 16.0 × 28.5 × 42.0 | 9.5 | 7.0 | B32656S8684+408 | T8 | 192 | | |
| | | 680 | 16.0 × 28.5 × 42.0 | 9.5 | 7.0 | B32656S8684+409 | T9 | 192 | | |
| | | 680 | 16.0 × 28.5 × 42.0 | 9.5 | 7.0 | B32656S8684+411 | T11 | 128 | | |
| | | 680 | 16.0 × 28.5 × 42.0 | 9.5 | 7.0 | B32656S8684+418 | T18 | 192 | | |
| | | 680 | 16.0 × 28.5 × 42.0 | 9.5 | 7.0 | B32656S8684+561 | T1 | 192 | | |
| | | 680 | 16.0 × 28.5 × 42.0 | 9.5 | 7.0 | B32656S8684+562 | T2 | 192 | | |
| | | 680 | 16.0 × 28.5 × 42.0 | 9.5 | 7.0 | B32656S8684+563 | T3 | 144 | | |
| | | 680 | 16.0 × 28.5 × 42.0 | 9.5 | 7.0 | B32656S8684+564 | T4 | 192 | | |
| | | 680 | 16.0 × 28.5 × 42.0 | 9.5 | 7.0 | B32656S8684+565 | T5 | 192 | | |
| | | 680 | 16.0 × 28.5 × 42.0 | 9.5 | 7.0 | B32656S8684+566 | T6 | 192 | | |
| | | 680 | 16.0 × 28.5 × 42.0 | 9.5 | 7.0 | B32656S8684+577 | T7 | 180 | | |
| | | 820 | 16.0 × 28.5 × 42.0 | 10.0 | 16.0 × 28.5 × 42.0 | 10.0 | 6.0 | B32656S8824+408 | T8 | 192 |
| | | 820 | 16.0 × 28.5 × 42.0 | 10.0 | 16.0 × 28.5 × 42.0 | 10.0 | 6.0 | B32656S8824+409 | T9 | 192 |
| | | 820 | 16.0 × 28.5 × 42.0 | 10.0 | 16.0 × 28.5 × 42.0 | 10.0 | 6.0 | B32656S8824+411 | T11 | 128 |
| | | 820 | 16.0 × 28.5 × 42.0 | 10.0 | 16.0 × 28.5 × 42.0 | 10.0 | 6.0 | B32656S8824+418 | T18 | 192 |
| | | 820 | 16.0 × 28.5 × 42.0 | 10.0 | 16.0 × 28.5 × 42.0 | 10.0 | 6.0 | B32656S8824+561 | T1 | 192 |
| | | 820 | 16.0 × 28.5 × 42.0 | 10.0 | 16.0 × 28.5 × 42.0 | 10.0 | 6.0 | B32656S8824+562 | T2 | 192 |
| | | 820 | 16.0 × 28.5 × 42.0 | 10.0 | 16.0 × 28.5 × 42.0 | 10.0 | 6.0 | B32656S8824+563 | T3 | 144 |
| | | 820 | 16.0 × 28.5 × 42.0 | 10.0 | 16.0 × 28.5 × 42.0 | 10.0 | 6.0 | B32656S8824+564 | T4 | 192 |
| | | 820 | 16.0 × 28.5 × 42.0 | 10.0 | 16.0 × 28.5 × 42.0 | 10.0 | 6.0 | B32656S8824+565 | T5 | 192 |
| | | 820 | 16.0 × 28.5 × 42.0 | 10.0 | 16.0 × 28.5 × 42.0 | 10.0 | 6.0 | B32656S8824+566 | T6 | 192 |
| | | 820 | 16.0 × 28.5 × 42.0 | 10.0 | 16.0 × 28.5 × 42.0 | 10.0 | 6.0 | B32656S8824+577 | T7 | 180 |

MOQ = Minimum Order Quantity, consisting of 4 packing units.

Further E series and intermediate capacitance values on request.

Composition of ordering code

+ = Capacitance tolerance code:

K = $\pm 10\%$

J = $\pm 5\%$

B32656S
Snubber (wound)
Ordering codes and packing units

| V_R | V_{RMS} $f \leq 1\text{kHz}$ | C_R | Max. dimensions $w \times h \times l$ | I_{RMS} 100 kHz | ESR_{typ} 100 kHz | Ordering code (composition see below) | Ter- minal | pcs./ MOQ | | |
|-------|-----------------------------------|-------|--|----------------------|------------------------|---|---------------|-----------------|-----|-----|
| V DC | V AC | nF | mm | A | m Ω | | | | | |
| 850 | 450 | 1000 | 18.0 × 32.5 × 42.0 | 11.5 | 6.0 | B32656S8105+408 | T8 | 140 | | |
| | | 1000 | 18.0 × 32.5 × 42.0 | 11.5 | 6.0 | B32656S8105+409 | T9 | 140 | | |
| | | 1000 | 18.0 × 32.5 × 42.0 | 11.5 | 6.0 | B32656S8105+411 | T11 | 112 | | |
| | | 1000 | 18.0 × 32.5 × 42.0 | 11.5 | 6.0 | B32656S8105+418 | T18 | 140 | | |
| | | 1000 | 18.0 × 32.5 × 42.0 | 11.5 | 6.0 | B32656S8105+561 | T1 | 140 | | |
| | | 1000 | 18.0 × 32.5 × 42.0 | 11.5 | 6.0 | B32656S8105+562 | T2 | 140 | | |
| | | 1000 | 18.0 × 32.5 × 42.0 | 11.5 | 6.0 | B32656S8105+563 | T3 | 120 | | |
| | | 1000 | 18.0 × 32.5 × 42.0 | 11.5 | 6.0 | B32656S8105+564 | T4 | 128 | | |
| | | 1000 | 18.0 × 32.5 × 42.0 | 11.5 | 6.0 | B32656S8105+565 | T5 | 128 | | |
| | | 1000 | 18.0 × 32.5 × 42.0 | 11.5 | 6.0 | B32656S8105+566 | T6 | 140 | | |
| | | 1000 | 18.0 × 32.5 × 42.0 | 11.5 | 6.0 | B32656S8105+577 | T7 | 156 | | |
| | | | | 1200 | 18.0 × 32.5 × 42.0 | 12.5 | 5.0 | B32656S8125+408 | T8 | 140 |
| | | | | 1200 | 18.0 × 32.5 × 42.0 | 12.5 | 5.0 | B32656S8125+409 | T9 | 140 |
| | | | | 1200 | 18.0 × 32.5 × 42.0 | 12.5 | 5.0 | B32656S8125+411 | T11 | 112 |
| | | | | 1200 | 18.0 × 32.5 × 42.0 | 12.5 | 5.0 | B32656S8125+418 | T18 | 140 |
| | | | | 1200 | 18.0 × 32.5 × 42.0 | 12.5 | 5.0 | B32656S8125+561 | T1 | 140 |
| | | | | 1200 | 18.0 × 32.5 × 42.0 | 12.5 | 5.0 | B32656S8125+562 | T2 | 140 |
| | | | | 1200 | 18.0 × 32.5 × 42.0 | 12.5 | 5.0 | B32656S8125+563 | T3 | 120 |
| | | | | 1200 | 18.0 × 32.5 × 42.0 | 12.5 | 5.0 | B32656S8125+564 | T4 | 128 |
| | | | | 1200 | 18.0 × 32.5 × 42.0 | 12.5 | 5.0 | B32656S8125+565 | T5 | 128 |
| | | | | 1200 | 18.0 × 32.5 × 42.0 | 12.5 | 5.0 | B32656S8125+566 | T6 | 140 |
| | | | | 1200 | 18.0 × 32.5 × 42.0 | 12.5 | 5.0 | B32656S8125+577 | T7 | 156 |
| | | | | 1500 | 31.0 × 26.5 × 43.6 | 14.0 | 5.0 | B32656S8155+408 | T8 | 128 |
| | | | | 1500 | 31.0 × 26.5 × 43.6 | 14.0 | 5.0 | B32656S8155+409 | T9 | 128 |
| | | | | 1500 | 31.0 × 26.5 × 43.6 | 14.0 | 5.0 | B32656S8155+418 | T18 | 128 |
| | | | | 1500 | 31.0 × 26.5 × 43.6 | 14.0 | 5.0 | B32656S8155+561 | T1 | 128 |
| | | | | 1500 | 31.0 × 26.5 × 43.6 | 14.0 | 5.0 | B32656S8155+562 | T2 | 128 |
| | | | | 1500 | 31.0 × 26.5 × 43.6 | 14.0 | 5.0 | B32656S8155+563 | T3 | 72 |
| | | | | 1500 | 31.0 × 26.5 × 43.6 | 14.0 | 5.0 | B32656S8155+566 | T6 | 128 |
| | | | | 1500 | 31.0 × 26.5 × 43.6 | 14.0 | 5.0 | B32656S8155+577 | T7 | 84 |

MOQ = Minimum Order Quantity, consisting of 4 packing units.

Further E series and intermediate capacitance values on request.

Composition of ordering code

+ = Capacitance tolerance code:

K = $\pm 10\%$

J = $\pm 5\%$

Ordering codes and packing units

| V_R | V_{RMS} $f \leq 1\text{kHz}$ | C_R | Max. dimensions $w \times h \times l$ | I_{RMS} 100 kHz | ESR_{typ} 100 kHz | Ordering code (composition see below) | Ter- minal | pcs./ MOQ |
|-------|-----------------------------------|-------|--|----------------------|------------------------|---|---------------|--------------|
| V DC | V AC | nF | mm | A | m Ω | | | |
| 850 | 450 | 1800 | 28.0 × 37.0 × 42.0 | 15.5 | 4.5 | B32656S8185+408 | T8 | 108 |
| | | 1800 | 28.0 × 37.0 × 42.0 | 15.5 | 4.5 | B32656S8185+409 | T9 | 108 |
| | | 1800 | 28.0 × 37.0 × 42.0 | 15.5 | 4.5 | B32656S8185+410 | T10 | 80 |
| | | 1800 | 28.0 × 37.0 × 42.0 | 15.5 | 4.5 | B32656S8185+411 | T11 | 72 |
| | | 1800 | 28.0 × 37.0 × 42.0 | 15.5 | 4.5 | B32656S8185+418 | T18 | 108 |
| | | 1800 | 28.0 × 37.0 × 42.0 | 15.5 | 4.5 | B32656S8185+561 | T1 | 108 |
| | | 1800 | 28.0 × 37.0 × 42.0 | 15.5 | 4.5 | B32656S8185+562 | T2 | 108 |
| | | 1800 | 28.0 × 37.0 × 42.0 | 15.5 | 4.5 | B32656S8185+563 | T3 | 96 |
| | | 1800 | 28.0 × 37.0 × 42.0 | 15.5 | 4.5 | B32656S8185+566 | T6 | 108 |
| | | 1800 | 28.0 × 37.0 × 42.0 | 15.5 | 4.5 | B32656S8185+577 | T7 | 96 |
| | | 2200 | 30.0 × 45.0 × 42.0 | 17.0 | 4.0 | B32656S8225+408 | T8 | 48 |
| | | 2200 | 30.0 × 45.0 × 42.0 | 17.0 | 4.0 | B32656S8225+409 | T9 | 48 |
| | | 2200 | 30.0 × 45.0 × 42.0 | 17.0 | 4.0 | B32656S8225+410 | T10 | 80 |
| | | 2200 | 30.0 × 45.0 × 42.0 | 17.0 | 4.0 | B32656S8225+411 | T11 | 64 |
| | | 2200 | 30.0 × 45.0 × 42.0 | 17.0 | 4.0 | B32656S8225+418 | T18 | 48 |
| | | 2200 | 30.0 × 45.0 × 42.0 | 17.0 | 4.0 | B32656S8225+561 | T1 | 48 |
| | | 2200 | 30.0 × 45.0 × 42.0 | 17.0 | 4.0 | B32656S8225+562 | T2 | 48 |
| | | 2200 | 30.0 × 45.0 × 42.0 | 17.0 | 4.0 | B32656S8225+563 | T3 | 96 |
| | | 2200 | 30.0 × 45.0 × 42.0 | 17.0 | 4.0 | B32656S8225+566 | T6 | 48 |
| | | 2200 | 30.0 × 45.0 × 42.0 | 17.0 | 4.0 | B32656S8225+577 | T7 | 96 |
| | | 2700 | 30.0 × 45.0 × 42.0 | 20.0 | 3.7 | B32656S8275+408 | T8 | 48 |
| | | 2700 | 30.0 × 45.0 × 42.0 | 20.0 | 3.7 | B32656S8275+409 | T9 | 48 |
| | | 2700 | 30.0 × 45.0 × 42.0 | 20.0 | 3.7 | B32656S8275+410 | T10 | 80 |
| | | 2700 | 30.0 × 45.0 × 42.0 | 20.0 | 3.7 | B32656S8275+411 | T11 | 64 |
| | | 2700 | 30.0 × 45.0 × 42.0 | 20.0 | 3.7 | B32656S8275+418 | T18 | 48 |
| | | 2700 | 30.0 × 45.0 × 42.0 | 20.0 | 3.7 | B32656S8275+561 | T1 | 48 |
| | | 2700 | 30.0 × 45.0 × 42.0 | 20.0 | 3.7 | B32656S8275+562 | T2 | 48 |
| | | 2700 | 30.0 × 45.0 × 42.0 | 20.0 | 3.7 | B32656S8275+563 | T3 | 96 |
| | | 2700 | 30.0 × 45.0 × 42.0 | 20.0 | 3.7 | B32656S8275+566 | T6 | 48 |
| | | 2700 | 30.0 × 45.0 × 42.0 | 20.0 | 3.7 | B32656S8275+577 | T7 | 96 |

MOQ = Minimum Order Quantity, consisting of 4 packing units.
Further E series and intermediate capacitance values on request.

Composition of ordering code

+ = Capacitance tolerance code:

K = $\pm 10\%$

J = $\pm 5\%$

B32656S
Snubber (wound)
Ordering codes and packing units

| V_R | V_{RMS} $f \leq 1\text{kHz}$ | C_R | Max. dimensions $w \times h \times l$ | I_{RMS} 100 kHz | ESR_{typ} 100 kHz | Ordering code (composition see below) | Ter- minal | pcs./ MOQ |
|-------|-----------------------------------|-------|--|----------------------|------------------------|---|---------------|--------------|
| V DC | V AC | nF | mm | A | m Ω | | | |
| 850 | 450 | 3300 | 33.0 × 48.0 × 43.0 | 23.0 | 3.3 | B32656S8335+408 | T8 | 84 |
| | | 3300 | 33.0 × 48.0 × 43.0 | 23.0 | 3.3 | B32656S8335+409 | T9 | 84 |
| | | 3300 | 33.0 × 48.0 × 43.0 | 23.0 | 3.3 | B32656S8335+410 | T10 | 60 |
| | | 3300 | 33.0 × 48.0 × 43.0 | 23.0 | 3.3 | B32656S8335+411 | T11 | 56 |
| | | 3300 | 33.0 × 48.0 × 43.0 | 23.0 | 3.3 | B32656S8335+418 | T18 | 84 |
| | | 3300 | 33.0 × 48.0 × 43.0 | 23.0 | 3.3 | B32656S8335+561 | T1 | 84 |
| | | 3300 | 33.0 × 48.0 × 43.0 | 23.0 | 3.3 | B32656S8335+562 | T2 | 84 |
| | | 3300 | 33.0 × 48.0 × 43.0 | 23.0 | 3.3 | B32656S8335+563 | T3 | 64 |
| | | 3300 | 33.0 × 48.0 × 43.0 | 23.0 | 3.3 | B32656S8335+566 | T6 | 84 |
| | | 3300 | 33.0 × 48.0 × 43.0 | 23.0 | 3.3 | B32656S8335+577 | T7 | 84 |
| 1000 | 480 | 330 | 14.0 × 25.0 × 42.0 | 7.0 | 13.0 | B32656S0334+408 | T8 | 288 |
| | | 330 | 14.0 × 25.0 × 42.0 | 7.0 | 13.0 | B32656S0334+418 | T18 | 288 |
| | | 330 | 14.0 × 25.0 × 42.0 | 7.0 | 13.0 | B32656S0334+563 | T3 | 168 |
| | | 330 | 14.0 × 25.0 × 42.0 | 7.0 | 13.0 | B32656S0334+564 | T4 | 288 |
| | | 330 | 14.0 × 25.0 × 42.0 | 7.0 | 13.0 | B32656S0334+565 | T5 | 288 |
| | | 390 | 14.0 × 25.0 × 42.0 | 7.5 | 11.0 | B32656S0394+408 | T8 | 288 |
| | | 390 | 14.0 × 25.0 × 42.0 | 7.5 | 11.0 | B32656S0394+418 | T18 | 288 |
| | | 390 | 14.0 × 25.0 × 42.0 | 7.5 | 11.0 | B32656S0394+563 | T3 | 168 |
| | | 390 | 14.0 × 25.0 × 42.0 | 7.5 | 11.0 | B32656S0394+564 | T4 | 288 |
| | | 390 | 14.0 × 25.0 × 42.0 | 7.5 | 11.0 | B32656S0394+565 | T5 | 288 |
| | | 470 | 14.0 × 25.0 × 42.0 | 8.0 | 10.0 | B32656S0474+408 | T8 | 288 |
| | | 470 | 14.0 × 25.0 × 42.0 | 8.0 | 10.0 | B32656S0474+418 | T18 | 288 |
| | | 470 | 14.0 × 25.0 × 42.0 | 8.0 | 10.0 | B32656S0474+563 | T3 | 168 |
| | | 470 | 14.0 × 25.0 × 42.0 | 8.0 | 10.0 | B32656S0474+564 | T4 | 288 |
| | | 470 | 14.0 × 25.0 × 42.0 | 8.0 | 10.0 | B32656S0474+565 | T5 | 288 |
| | | 560 | 16.0 × 28.5 × 42.0 | 9.0 | 8.0 | B32656S0564+408 | T8 | 192 |
| | | 560 | 16.0 × 28.5 × 42.0 | 9.0 | 8.0 | B32656S0564+409 | T9 | 192 |
| | | 560 | 16.0 × 28.5 × 42.0 | 9.0 | 8.0 | B32656S0564+411 | T11 | 128 |
| | | 560 | 16.0 × 28.5 × 42.0 | 9.0 | 8.0 | B32656S0564+418 | T18 | 192 |

MOQ = Minimum Order Quantity, consisting of 4 packing units.

Further E series and intermediate capacitance values on request.

Composition of ordering code

+ = Capacitance tolerance code:

K = $\pm 10\%$

J = $\pm 5\%$

Ordering codes and packing units

| V_R | V_{RMS} $f \leq 1\text{kHz}$ | C_R | Max. dimensions $w \times h \times l$ | I_{RMS} 100 kHz | ESR_{typ} 100 kHz | Ordering code (composition see below) | Ter- minal | pcs./ MOQ |
|-------|-----------------------------------|-------|--|----------------------|------------------------|---|---------------|--------------|
| V DC | V AC | nF | mm | A | m Ω | | | |
| 1000 | 480 | 560 | 16.0 × 28.5 × 42.0 | 9.0 | 8.0 | B32656S0564+561 | T1 | 192 |
| | | 560 | 16.0 × 28.5 × 42.0 | 9.0 | 8.0 | B32656S0564+562 | T2 | 192 |
| | | 560 | 16.0 × 28.5 × 42.0 | 9.0 | 8.0 | B32656S0564+563 | T3 | 144 |
| | | 560 | 16.0 × 28.5 × 42.0 | 9.0 | 8.0 | B32656S0564+564 | T4 | 192 |
| | | 560 | 16.0 × 28.5 × 42.0 | 9.0 | 8.0 | B32656S0564+565 | T5 | 192 |
| | | 560 | 16.0 × 28.5 × 42.0 | 9.0 | 8.0 | B32656S0564+566 | T6 | 192 |
| | | 560 | 16.0 × 28.5 × 42.0 | 9.0 | 8.0 | B32656S0564+577 | T7 | 180 |
| | | 680 | 16.0 × 28.5 × 42.0 | 10.5 | 6.5 | B32656S0684+408 | T8 | 192 |
| | | 680 | 16.0 × 28.5 × 42.0 | 10.5 | 6.5 | B32656S0684+409 | T9 | 192 |
| | | 680 | 16.0 × 28.5 × 42.0 | 10.5 | 6.5 | B32656S0684+411 | T11 | 128 |
| | | 680 | 16.0 × 28.5 × 42.0 | 10.5 | 6.5 | B32656S0684+418 | T18 | 192 |
| | | 680 | 16.0 × 28.5 × 42.0 | 10.5 | 6.5 | B32656S0684+561 | T1 | 192 |
| | | 680 | 16.0 × 28.5 × 42.0 | 10.5 | 6.5 | B32656S0684+562 | T2 | 192 |
| | | 680 | 16.0 × 28.5 × 42.0 | 10.5 | 6.5 | B32656S0684+563 | T3 | 144 |
| | | 680 | 16.0 × 28.5 × 42.0 | 10.5 | 6.5 | B32656S0684+564 | T4 | 192 |
| | | 680 | 16.0 × 28.5 × 42.0 | 10.5 | 6.5 | B32656S0684+565 | T5 | 192 |
| | | 680 | 16.0 × 28.5 × 42.0 | 10.5 | 6.5 | B32656S0684+566 | T6 | 192 |
| | | 680 | 16.0 × 28.5 × 42.0 | 10.5 | 6.5 | B32656S0684+577 | T7 | 180 |
| | | 680 | 19.0 × 37.5 × 42.0 | 18.0 | 3.0 | B32656S0684+412 | T12 | 264 |
| | | 820 | 18.0 × 32.5 × 42.0 | 11.5 | 6.0 | B32656S0824+408 | T8 | 140 |
| | | 820 | 18.0 × 32.5 × 42.0 | 11.5 | 6.0 | B32656S0824+409 | T9 | 140 |
| | | 820 | 18.0 × 32.5 × 42.0 | 11.5 | 6.0 | B32656S0824+411 | T11 | 112 |
| | | 820 | 18.0 × 32.5 × 42.0 | 11.5 | 6.0 | B32656S0824+418 | T18 | 140 |
| | | 820 | 18.0 × 32.5 × 42.0 | 11.5 | 6.0 | B32656S0824+561 | T1 | 140 |
| | | 820 | 18.0 × 32.5 × 42.0 | 11.5 | 6.0 | B32656S0824+562 | T2 | 140 |
| | | 820 | 18.0 × 32.5 × 42.0 | 11.5 | 6.0 | B32656S0824+563 | T3 | 120 |
| | | 820 | 18.0 × 32.5 × 42.0 | 11.5 | 6.0 | B32656S0824+564 | T4 | 128 |
| | | 820 | 18.0 × 32.5 × 42.0 | 11.5 | 6.0 | B32656S0824+565 | T5 | 128 |
| | | 820 | 18.0 × 32.5 × 42.0 | 11.5 | 6.0 | B32656S0824+566 | T6 | 140 |
| | | 820 | 18.0 × 32.5 × 42.0 | 11.5 | 6.0 | B32656S0824+577 | T7 | 156 |
| | | 1000 | 20.0 × 39.5 × 42.0 | 13.0 | 6.0 | B32656S0105+408 | T8 | 96 |
| | | 1000 | 20.0 × 39.5 × 42.0 | 13.0 | 6.0 | B32656S0105+409 | T9 | 96 |
| | | 1000 | 20.0 × 39.5 × 42.0 | 13.0 | 6.0 | B32656S0105+410 | T10 | 120 |

MOQ = Minimum Order Quantity, consisting of 4 packing units.

Further E series and intermediate capacitance values on request.

Composition of ordering code

+ = Capacitance tolerance code:

K = $\pm 10\%$

J = $\pm 5\%$

B32656S
Snubber (wound)
Ordering codes and packing units

| V_R | V_{RMS} $f \leq 1\text{kHz}$ | C_R | Max. dimensions $w \times h \times l$ | I_{RMS} 100 kHz | ESR_{typ} 100 kHz | Ordering code (composition see below) | Ter- minal | pcs./ MOQ | | |
|-------|-----------------------------------|-------|--|----------------------|------------------------|---|---------------|-----------------|-----|-----|
| V DC | V AC | nF | mm | A | m Ω | | | | | |
| 1000 | 480 | 1000 | 20.0 × 39.5 × 42.0 | 13.0 | 6.0 | B32656S0105+411 | T11 | 96 | | |
| | | 1000 | 20.0 × 39.5 × 42.0 | 13.0 | 6.0 | B32656S0105+418 | T18 | 96 | | |
| | | 1000 | 20.0 × 39.5 × 42.0 | 13.0 | 6.0 | B32656S0105+561 | T1 | 96 | | |
| | | 1000 | 20.0 × 39.5 × 42.0 | 13.0 | 6.0 | B32656S0105+562 | T2 | 96 | | |
| | | 1000 | 20.0 × 39.5 × 42.0 | 13.0 | 6.0 | B32656S0105+563 | T3 | 104 | | |
| | | 1000 | 20.0 × 39.5 × 42.0 | 13.0 | 6.0 | B32656S0105+564 | T4 | 96 | | |
| | | 1000 | 20.0 × 39.5 × 42.0 | 13.0 | 6.0 | B32656S0105+565 | T5 | 96 | | |
| | | 1000 | 20.0 × 39.5 × 42.0 | 13.0 | 6.0 | B32656S0105+566 | T6 | 96 | | |
| | | 1000 | 20.0 × 39.5 × 42.0 | 13.0 | 6.0 | B32656S0105+577 | T7 | 144 | | |
| | | | | 1200 | 20.0 × 39.5 × 42.0 | 14.0 | 5.0 | B32656S0125+408 | T8 | 96 |
| | | | | 1200 | 20.0 × 39.5 × 42.0 | 14.0 | 5.0 | B32656S0125+409 | T9 | 96 |
| | | | | 1200 | 20.0 × 39.5 × 42.0 | 14.0 | 5.0 | B32656S0125+410 | T10 | 120 |
| | | | | 1200 | 20.0 × 39.5 × 42.0 | 14.0 | 5.0 | B32656S0125+411 | T11 | 96 |
| | | | | 1200 | 20.0 × 39.5 × 42.0 | 14.0 | 5.0 | B32656S0125+418 | T18 | 96 |
| | | | | 1200 | 20.0 × 39.5 × 42.0 | 14.0 | 5.0 | B32656S0125+561 | T1 | 96 |
| | | | | 1200 | 20.0 × 39.5 × 42.0 | 14.0 | 5.0 | B32656S0125+562 | T2 | 96 |
| | | | | 1200 | 20.0 × 39.5 × 42.0 | 14.0 | 5.0 | B32656S0125+563 | T3 | 104 |
| | | | | 1200 | 20.0 × 39.5 × 42.0 | 14.0 | 5.0 | B32656S0125+564 | T4 | 96 |
| | | | | 1200 | 20.0 × 39.5 × 42.0 | 14.0 | 5.0 | B32656S0125+565 | T5 | 96 |
| | | | | 1200 | 20.0 × 39.5 × 42.0 | 14.0 | 5.0 | B32656S0125+566 | T6 | 96 |
| | | | | 1200 | 20.0 × 39.5 × 42.0 | 14.0 | 5.0 | B32656S0125+577 | T7 | 144 |
| | | | | 1500 | 30.0 × 45.0 × 42.0 | 16.5 | 5.0 | B32656S0155+408 | T8 | 48 |
| | | | | 1500 | 30.0 × 45.0 × 42.0 | 16.5 | 5.0 | B32656S0155+409 | T9 | 48 |
| | | | | 1500 | 30.0 × 45.0 × 42.0 | 16.5 | 5.0 | B32656S0155+410 | T10 | 80 |
| | | | | 1500 | 30.0 × 45.0 × 42.0 | 16.5 | 5.0 | B32656S0155+411 | T11 | 64 |
| | | | | 1500 | 30.0 × 45.0 × 42.0 | 16.5 | 5.0 | B32656S0155+418 | T18 | 48 |
| | | | | 1500 | 30.0 × 45.0 × 42.0 | 16.5 | 5.0 | B32656S0155+561 | T1 | 48 |
| | | | | 1500 | 30.0 × 45.0 × 42.0 | 16.5 | 5.0 | B32656S0155+562 | T2 | 48 |
| | | | | 1500 | 30.0 × 45.0 × 42.0 | 16.5 | 5.0 | B32656S0155+563 | T3 | 96 |
| | | | | 1500 | 30.0 × 45.0 × 42.0 | 16.5 | 5.0 | B32656S0155+566 | T6 | 48 |
| | | | | 1500 | 30.0 × 45.0 × 42.0 | 16.5 | 5.0 | B32656S0155+577 | T7 | 96 |

MOQ = Minimum Order Quantity, consisting of 4 packing units.

Further E series and intermediate capacitance values on request.

Composition of ordering code

+ = Capacitance tolerance code:

K = $\pm 10\%$

J = $\pm 5\%$

Ordering codes and packing units

| V_R | V_{RMS} $f \leq 1\text{kHz}$ | C_R | Max. dimensions $w \times h \times l$ | I_{RMS} 100 kHz | ESR_{typ} 100 kHz | Ordering code (composition see below) | Ter- minal | pcs./ MOQ | |
|-------|-----------------------------------|-------|--|----------------------|------------------------|---|-----------------|--------------|----|
| V DC | V AC | nF | mm | A | m Ω | | | | |
| 1000 | 480 | 1800 | 30.0 × 45.0 × 42.0 | 17.0 | 4.5 | B32656S0185+408 | T8 | 48 | |
| | | 1800 | 30.0 × 45.0 × 42.0 | 17.0 | 4.5 | B32656S0185+409 | T9 | 48 | |
| | | 1800 | 30.0 × 45.0 × 42.0 | 17.0 | 4.5 | B32656S0185+410 | T10 | 48 | |
| | | 1800 | 30.0 × 45.0 × 42.0 | 17.0 | 4.5 | B32656S0185+411 | T11 | 64 | |
| | | 1800 | 30.0 × 45.0 × 42.0 | 17.0 | 4.5 | B32656S0185+418 | T18 | 48 | |
| | | 1800 | 30.0 × 45.0 × 42.0 | 17.0 | 4.5 | B32656S0185+561 | T1 | 48 | |
| | | 1800 | 30.0 × 45.0 × 42.0 | 17.0 | 4.5 | B32656S0185+562 | T2 | 48 | |
| | | 1800 | 30.0 × 45.0 × 42.0 | 17.0 | 4.5 | B32656S0185+563 | T3 | 96 | |
| | | 1800 | 30.0 × 45.0 × 42.0 | 17.0 | 4.5 | B32656S0185+566 | T6 | 48 | |
| | | 1800 | 30.0 × 45.0 × 42.0 | 17.0 | 4.5 | B32656S0185+577 | T7 | 96 | |
| | 2200 | 480 | 2200 | 30.0 × 45.0 × 42.0 | 19.0 | 4.0 | B32656S0225+408 | T8 | 48 |
| | | | 2200 | 30.0 × 45.0 × 42.0 | 19.0 | 4.0 | B32656S0225+409 | T9 | 48 |
| | | | 2200 | 30.0 × 45.0 × 42.0 | 19.0 | 4.0 | B32656S0225+410 | T10 | 80 |
| | | | 2200 | 30.0 × 45.0 × 42.0 | 19.0 | 4.0 | B32656S0225+411 | T11 | 64 |
| | | | 2200 | 30.0 × 45.0 × 42.0 | 19.0 | 4.0 | B32656S0225+418 | T18 | 48 |
| | | | 2200 | 30.0 × 45.0 × 42.0 | 19.0 | 4.0 | B32656S0225+561 | T1 | 48 |
| | | | 2200 | 30.0 × 45.0 × 42.0 | 19.0 | 4.0 | B32656S0225+562 | T2 | 48 |
| | | | 2200 | 30.0 × 45.0 × 42.0 | 19.0 | 4.0 | B32656S0225+563 | T3 | 96 |
| | | | 2200 | 30.0 × 45.0 × 42.0 | 19.0 | 4.0 | B32656S0225+566 | T6 | 48 |
| | | | 2200 | 30.0 × 45.0 × 42.0 | 19.0 | 4.0 | B32656S0225+577 | T7 | 96 |
| | 2700 | 480 | 2700 | 33.0 × 48.0 × 43.0 | 22.0 | 3.3 | B32656S0275+408 | T8 | 84 |
| | | | 2700 | 33.0 × 48.0 × 43.0 | 22.0 | 3.3 | B32656S0275+409 | T9 | 84 |
| | | | 2700 | 33.0 × 48.0 × 43.0 | 22.0 | 3.3 | B32656S0275+410 | T10 | 60 |
| | | | 2700 | 33.0 × 48.0 × 43.0 | 22.0 | 3.3 | B32656S0275+411 | T11 | 56 |
| | | | 2700 | 33.0 × 48.0 × 43.0 | 22.0 | 3.3 | B32656S0275+418 | T18 | 84 |
| | | | 2700 | 33.0 × 48.0 × 43.0 | 22.0 | 3.3 | B32656S0275+561 | T1 | 84 |
| | | | 2700 | 33.0 × 48.0 × 43.0 | 22.0 | 3.3 | B32656S0275+562 | T2 | 84 |
| | | | 2700 | 33.0 × 48.0 × 43.0 | 22.0 | 3.3 | B32656S0275+563 | T3 | 64 |
| | | | 2700 | 33.0 × 48.0 × 43.0 | 22.0 | 3.3 | B32656S0275+566 | T6 | 84 |
| | | | 2700 | 33.0 × 48.0 × 43.0 | 22.0 | 3.3 | B32656S0275+577 | T7 | 84 |

MOQ = Minimum Order Quantity, consisting of 4 packing units.
Further E series and intermediate capacitance values on request.

Composition of ordering code

+ = Capacitance tolerance code:

K = $\pm 10\%$

J = $\pm 5\%$

B32656S
Snubber (wound)
Ordering codes and packing units

| V_R | V_{RMS} $f \leq 1\text{kHz}$ | C_R | Max. dimensions $w \times h \times l$ | I_{RMS} 100 kHz | ESR_{typ} 100 kHz | Ordering code (composition see below) | Ter- minal | pcs./ MOQ |
|-------|-----------------------------------|-------|--|----------------------|------------------------|---|---------------|--------------|
| V DC | V AC | nF | mm | A | m Ω | | | |
| 1250 | 500 | 220 | 14.0 × 25.0 × 42.0 | 7.0 | 11.5 | B32656S7224+408 | T8 | 288 |
| | | 220 | 14.0 × 25.0 × 42.0 | 7.0 | 11.5 | B32656S7224+418 | T18 | 288 |
| | | 220 | 14.0 × 25.0 × 42.0 | 7.0 | 11.5 | B32656S7224+563 | T3 | 168 |
| | | 220 | 14.0 × 25.0 × 42.0 | 7.0 | 11.5 | B32656S7224+564 | T4 | 288 |
| | | 220 | 14.0 × 25.0 × 42.0 | 7.0 | 11.5 | B32656S7224+565 | T5 | 288 |
| | | 270 | 14.0 × 25.0 × 42.0 | 8.0 | 10.0 | B32656S7274+408 | T8 | 288 |
| | | 270 | 14.0 × 25.0 × 42.0 | 8.0 | 10.0 | B32656S7274+418 | T18 | 288 |
| | | 270 | 14.0 × 25.0 × 42.0 | 8.0 | 10.0 | B32656S7274+563 | T3 | 168 |
| | | 270 | 14.0 × 25.0 × 42.0 | 8.0 | 10.0 | B32656S7274+564 | T4 | 288 |
| | | 270 | 14.0 × 25.0 × 42.0 | 8.0 | 10.0 | B32656S7274+565 | T5 | 288 |
| | | 330 | 16.0 × 28.5 × 42.0 | 8.5 | 9.5 | B32656S7334+408 | T8 | 192 |
| | | 330 | 16.0 × 28.5 × 42.0 | 8.5 | 9.5 | B32656S7334+409 | T9 | 192 |
| | | 330 | 16.0 × 28.5 × 42.0 | 8.5 | 9.5 | B32656S7334+411 | T11 | 128 |
| | | 330 | 16.0 × 28.5 × 42.0 | 8.5 | 9.5 | B32656S7334+418 | T18 | 192 |
| | | 330 | 16.0 × 28.5 × 42.0 | 8.5 | 9.5 | B32656S7334+561 | T1 | 192 |
| | | 330 | 16.0 × 28.5 × 42.0 | 8.5 | 9.5 | B32656S7334+562 | T2 | 192 |
| | | 330 | 16.0 × 28.5 × 42.0 | 8.5 | 9.5 | B32656S7334+563 | T3 | 144 |
| | | 330 | 16.0 × 28.5 × 42.0 | 8.5 | 9.5 | B32656S7334+564 | T4 | 192 |
| | | 330 | 16.0 × 28.5 × 42.0 | 8.5 | 9.5 | B32656S7334+565 | T5 | 192 |
| | | 330 | 16.0 × 28.5 × 42.0 | 8.5 | 9.5 | B32656S7334+566 | T6 | 192 |
| | | 330 | 16.0 × 28.5 × 42.0 | 8.5 | 9.5 | B32656S7334+577 | T7 | 180 |
| | | 390 | 18.0 × 32.5 × 42.0 | 9.0 | 9.0 | B32656S7394+408 | T8 | 140 |
| | | 390 | 18.0 × 32.5 × 42.0 | 9.0 | 9.0 | B32656S7394+409 | T9 | 140 |
| | | 390 | 18.0 × 32.5 × 42.0 | 9.0 | 9.0 | B32656S7394+411 | T11 | 112 |
| | | 390 | 18.0 × 32.5 × 42.0 | 9.0 | 9.0 | B32656S7394+418 | T18 | 140 |
| | | 390 | 18.0 × 32.5 × 42.0 | 9.0 | 9.0 | B32656S7394+561 | T1 | 140 |
| | | 390 | 18.0 × 32.5 × 42.0 | 9.0 | 9.0 | B32656S7394+562 | T2 | 140 |
| | | 390 | 18.0 × 32.5 × 42.0 | 9.0 | 9.0 | B32656S7394+563 | T3 | 120 |
| | | 390 | 18.0 × 32.5 × 42.0 | 9.0 | 9.0 | B32656S7394+564 | T4 | 128 |
| | | 390 | 18.0 × 32.5 × 42.0 | 9.0 | 9.0 | B32656S7394+565 | T5 | 128 |
| | | 390 | 18.0 × 32.5 × 42.0 | 9.0 | 9.0 | B32656S7394+566 | T6 | 140 |
| | | 390 | 18.0 × 32.5 × 42.0 | 9.0 | 9.0 | B32656S7394+577 | T7 | 156 |

MOQ = Minimum Order Quantity, consisting of 4 packing units.

Further E series and intermediate capacitance values on request.

Composition of ordering code

+ = Capacitance tolerance code:

K = $\pm 10\%$

J = $\pm 5\%$

Ordering codes and packing units

| V_R | V_{RMS} $f \leq 1\text{kHz}$ | C_R | Max. dimensions $w \times h \times l$ | I_{RMS} 100 kHz | ESR_{typ} 100 kHz | Ordering code (composition see below) | Ter- minal | pcs./ MOQ | | |
|-------|-----------------------------------|-------|--|----------------------|------------------------|---|---------------|-----------------|-----|-----|
| V DC | V AC | nF | mm | A | m Ω | | | | | |
| 1250 | 500 | 470 | 18.0 × 32.5 × 42.0 | 9.0 | 8.5 | B32656S7474+408 | T8 | 140 | | |
| | | 470 | 18.0 × 32.5 × 42.0 | 9.0 | 8.5 | B32656S7474+409 | T9 | 140 | | |
| | | 470 | 18.0 × 32.5 × 42.0 | 9.0 | 8.5 | B32656S7474+411 | T11 | 112 | | |
| | | 470 | 18.0 × 32.5 × 42.0 | 9.0 | 8.5 | B32656S7474+418 | T18 | 140 | | |
| | | 470 | 18.0 × 32.5 × 42.0 | 9.0 | 8.5 | B32656S7474+561 | T1 | 140 | | |
| | | 470 | 18.0 × 32.5 × 42.0 | 9.0 | 8.5 | B32656S7474+562 | T2 | 140 | | |
| | | 470 | 18.0 × 32.5 × 42.0 | 9.0 | 8.5 | B32656S7474+563 | T3 | 120 | | |
| | | 470 | 18.0 × 32.5 × 42.0 | 9.0 | 8.5 | B32656S7474+564 | T4 | 128 | | |
| | | 470 | 18.0 × 32.5 × 42.0 | 9.0 | 8.5 | B32656S7474+565 | T5 | 128 | | |
| | | 470 | 18.0 × 32.5 × 42.0 | 9.0 | 8.5 | B32656S7474+566 | T6 | 140 | | |
| | | 470 | 18.0 × 32.5 × 42.0 | 9.0 | 8.5 | B32656S7474+577 | T7 | 156 | | |
| | | 470 | 19.0 × 37.5 × 42.0 | 17.0 | 4.0 | B32656S7474+412 | T12 | 264 | | |
| | | | | 560 | 20.0 × 39.5 × 42.0 | 11.0 | 7.0 | B32656S7564+408 | T8 | 96 |
| | | | | 560 | 20.0 × 39.5 × 42.0 | 11.0 | 7.0 | B32656S7564+409 | T9 | 96 |
| | | | | 560 | 20.0 × 39.5 × 42.0 | 11.0 | 7.0 | B32656S7564+410 | T10 | 120 |
| | | | | 560 | 20.0 × 39.5 × 42.0 | 11.0 | 7.0 | B32656S7564+411 | T11 | 96 |
| | | | | 560 | 20.0 × 39.5 × 42.0 | 11.0 | 7.0 | B32656S7564+418 | T18 | 96 |
| | | | | 560 | 20.0 × 39.5 × 42.0 | 11.0 | 7.0 | B32656S7564+561 | T1 | 96 |
| | | | | 560 | 20.0 × 39.5 × 42.0 | 11.0 | 7.0 | B32656S7564+562 | T2 | 96 |
| | | | | 560 | 20.0 × 39.5 × 42.0 | 11.0 | 7.0 | B32656S7564+563 | T3 | 104 |
| | | | | 560 | 20.0 × 39.5 × 42.0 | 11.0 | 7.0 | B32656S7564+564 | T4 | 96 |
| | | | | 560 | 20.0 × 39.5 × 42.0 | 11.0 | 7.0 | B32656S7564+565 | T5 | 96 |
| | | | | 560 | 20.0 × 39.5 × 42.0 | 11.0 | 7.0 | B32656S7564+566 | T6 | 96 |
| | | | | 560 | 20.0 × 39.5 × 42.0 | 11.0 | 7.0 | B32656S7564+577 | T7 | 144 |
| | | | | 680 | 20.0 × 39.5 × 42.0 | 13.0 | 6.0 | B32656S7684+408 | T8 | 96 |
| | | | | 680 | 20.0 × 39.5 × 42.0 | 13.0 | 6.0 | B32656S7684+409 | T9 | 96 |
| | | | | 680 | 20.0 × 39.5 × 42.0 | 13.0 | 6.0 | B32656S7684+410 | T10 | 120 |
| | | | | 680 | 20.0 × 39.5 × 42.0 | 13.0 | 6.0 | B32656S7684+411 | T11 | 96 |
| | | | | 680 | 20.0 × 39.5 × 42.0 | 13.0 | 6.0 | B32656S7684+418 | T18 | 96 |
| | | | | 680 | 20.0 × 39.5 × 42.0 | 13.0 | 6.0 | B32656S7684+561 | T1 | 96 |
| | | | | 680 | 20.0 × 39.5 × 42.0 | 13.0 | 6.0 | B32656S7684+562 | T2 | 96 |

MOQ = Minimum Order Quantity, consisting of 4 packing units.

Further E series and intermediate capacitance values on request.

Composition of ordering code

+ = Capacitance tolerance code:

K = $\pm 10\%$

J = $\pm 5\%$



B32656S

Snubber (wound)

Ordering codes and packing units

| V_R | V_{RMS} $f \leq 1\text{kHz}$ | C_R | Max. dimensions $w \times h \times l$ | I_{RMS} 100 kHz | ESR_{typ} 100 kHz | Ordering code (composition see below) | Ter- minal | pcs./ MOQ |
|-------|-----------------------------------|-------|--|----------------------|------------------------|---|---------------|--------------|
| V DC | V AC | nF | mm | A | m Ω | | | |
| 1250 | 500 | 680 | 20.0 × 39.5 × 42.0 | 13.0 | 6.0 | B32656S7684+563 | T3 | 104 |
| | | 680 | 20.0 × 39.5 × 42.0 | 13.0 | 6.0 | B32656S7684+564 | T4 | 96 |
| | | 680 | 20.0 × 39.5 × 42.0 | 13.0 | 6.0 | B32656S7684+565 | T5 | 96 |
| | | 680 | 20.0 × 39.5 × 42.0 | 13.0 | 6.0 | B32656S7684+566 | T6 | 96 |
| | | 680 | 20.0 × 39.5 × 42.0 | 13.0 | 6.0 | B32656S7684+577 | T7 | 144 |
| | | 820 | 28.0 × 37.0 × 42.0 | 14.0 | 5.5 | B32656S7824+408 | T8 | 108 |
| | | 820 | 28.0 × 37.0 × 42.0 | 14.0 | 5.5 | B32656S7824+409 | T9 | 108 |
| | | 820 | 28.0 × 37.0 × 42.0 | 14.0 | 5.5 | B32656S7824+410 | T10 | 80 |
| | | 820 | 28.0 × 37.0 × 42.0 | 14.0 | 5.5 | B32656S7824+411 | T11 | 72 |
| | | 820 | 28.0 × 37.0 × 42.0 | 14.0 | 5.5 | B32656S7824+418 | T18 | 108 |
| | | 820 | 28.0 × 37.0 × 42.0 | 14.0 | 5.5 | B32656S7824+561 | T1 | 108 |
| | | 820 | 28.0 × 37.0 × 42.0 | 14.0 | 5.5 | B32656S7824+562 | T2 | 108 |
| | | 820 | 28.0 × 37.0 × 42.0 | 14.0 | 5.5 | B32656S7824+563 | T3 | 96 |
| | | 820 | 28.0 × 37.0 × 42.0 | 14.0 | 5.5 | B32656S7824+566 | T6 | 108 |
| | | 820 | 28.0 × 37.0 × 42.0 | 14.0 | 5.5 | B32656S7824+577 | T7 | 96 |
| | | 1000 | 28.0 × 37.0 × 42.0 | 15.5 | 5.0 | B32656S7105+408 | T8 | 108 |
| | | 1000 | 28.0 × 37.0 × 42.0 | 15.5 | 5.0 | B32656S7105+409 | T9 | 108 |
| | | 1000 | 28.0 × 37.0 × 42.0 | 15.5 | 5.0 | B32656S7105+410 | T10 | 80 |
| | | 1000 | 28.0 × 37.0 × 42.0 | 15.5 | 5.0 | B32656S7105+411 | T11 | 72 |
| | | 1000 | 28.0 × 37.0 × 42.0 | 15.5 | 5.0 | B32656S7105+418 | T18 | 108 |
| | | 1000 | 28.0 × 37.0 × 42.0 | 15.5 | 5.0 | B32656S7105+561 | T1 | 108 |
| | | 1000 | 28.0 × 37.0 × 42.0 | 15.5 | 5.0 | B32656S7105+562 | T2 | 108 |
| | | 1000 | 28.0 × 37.0 × 42.0 | 15.5 | 5.0 | B32656S7105+563 | T3 | 96 |
| | | 1000 | 28.0 × 37.0 × 42.0 | 15.5 | 5.0 | B32656S7105+566 | T6 | 108 |
| | | 1000 | 28.0 × 37.0 × 42.0 | 15.5 | 5.0 | B32656S7105+577 | T7 | 96 |
| | | 1200 | 30.0 × 45.0 × 42.0 | 17.0 | 4.5 | B32656S7125+408 | T8 | 48 |
| | | 1200 | 30.0 × 45.0 × 42.0 | 17.0 | 4.5 | B32656S7125+409 | T9 | 48 |
| | | 1200 | 30.0 × 45.0 × 42.0 | 17.0 | 4.5 | B32656S7125+410 | T10 | 80 |
| | | 1200 | 30.0 × 45.0 × 42.0 | 17.0 | 4.5 | B32656S7125+411 | T11 | 64 |
| | | 1200 | 30.0 × 45.0 × 42.0 | 17.0 | 4.5 | B32656S7125+418 | T18 | 48 |

MOQ = Minimum Order Quantity, consisting of 4 packing units.
Further E series and intermediate capacitance values on request.

Composition of ordering code

+ = Capacitance tolerance code:

K = ±10%

J = ±5%

Ordering codes and packing units

| V_R | V_{RMS} $f \leq 1\text{kHz}$ | C_R | Max. dimensions $w \times h \times l$ | I_{RMS} 100 kHz | ESR_{typ} 100 kHz | Ordering code (composition see below) | Ter- minal | pcs./ MOQ | | |
|-------|-----------------------------------|-------|--|----------------------|------------------------|---|---------------|-----------------|-----|-----|
| V DC | V AC | nF | mm | A | m Ω | | | | | |
| 1250 | 500 | 1200 | 30.0 × 45.0 × 42.0 | 17.0 | 4.5 | B32656S7125+561 | T1 | 48 | | |
| | | 1200 | 30.0 × 45.0 × 42.0 | 17.0 | 4.5 | B32656S7125+562 | T2 | 48 | | |
| | | 1200 | 30.0 × 45.0 × 42.0 | 17.0 | 4.5 | B32656S7125+563 | T3 | 96 | | |
| | | 1200 | 30.0 × 45.0 × 42.0 | 17.0 | 4.5 | B32656S7125+566 | T6 | 48 | | |
| | | 1200 | 30.0 × 45.0 × 42.0 | 17.0 | 4.5 | B32656S7125+577 | T7 | 96 | | |
| | | 1500 | 30.0 × 45.0 × 42.0 | 19.0 | 4.0 | B32656S7155+408 | T8 | 48 | | |
| | | 1500 | 30.0 × 45.0 × 42.0 | 19.0 | 4.0 | B32656S7155+409 | T9 | 48 | | |
| | | 1500 | 30.0 × 45.0 × 42.0 | 19.0 | 4.0 | B32656S7155+410 | T10 | 80 | | |
| | | 1500 | 30.0 × 45.0 × 42.0 | 19.0 | 4.0 | B32656S7155+411 | T11 | 64 | | |
| | | 1500 | 30.0 × 45.0 × 42.0 | 19.0 | 4.0 | B32656S7155+418 | T18 | 48 | | |
| | | 1500 | 30.0 × 45.0 × 42.0 | 19.0 | 4.0 | B32656S7155+561 | T1 | 48 | | |
| | | 1500 | 30.0 × 45.0 × 42.0 | 19.0 | 4.0 | B32656S7155+562 | T2 | 48 | | |
| | | 1500 | 30.0 × 45.0 × 42.0 | 19.0 | 4.0 | B32656S7155+563 | T3 | 96 | | |
| | | 1500 | 30.0 × 45.0 × 42.0 | 19.0 | 4.0 | B32656S7155+566 | T6 | 48 | | |
| | | 1500 | 30.0 × 45.0 × 42.0 | 19.0 | 4.0 | B32656S7155+577 | T7 | 96 | | |
| | | 1800 | 33.0 × 48.0 × 43.0 | 22.0 | 3.5 | B32656S7185+408 | T8 | 84 | | |
| | | 1800 | 33.0 × 48.0 × 43.0 | 22.0 | 3.5 | B32656S7185+409 | T9 | 84 | | |
| | | 1800 | 33.0 × 48.0 × 43.0 | 22.0 | 3.5 | B32656S7185+410 | T10 | 60 | | |
| | | 1800 | 33.0 × 48.0 × 43.0 | 22.0 | 3.5 | B32656S7185+411 | T11 | 56 | | |
| | | 1800 | 33.0 × 48.0 × 43.0 | 22.0 | 3.5 | B32656S7185+418 | T18 | 84 | | |
| | | 1800 | 33.0 × 48.0 × 43.0 | 22.0 | 3.5 | B32656S7185+561 | T1 | 84 | | |
| | | 1800 | 33.0 × 48.0 × 43.0 | 22.0 | 3.5 | B32656S7185+562 | T2 | 84 | | |
| | | 1800 | 33.0 × 48.0 × 43.0 | 22.0 | 3.5 | B32656S7185+563 | T3 | 64 | | |
| | | 1800 | 33.0 × 48.0 × 43.0 | 22.0 | 3.5 | B32656S7185+566 | T6 | 84 | | |
| | | 1800 | 33.0 × 48.0 × 43.0 | 22.0 | 3.5 | B32656S7185+577 | T7 | 84 | | |
| | | 1700 | 750 | 120 | 14.0 × 25.0 × 42.0 | 6.5 | 14.0 | B32656S1124+408 | T8 | 288 |
| | | | | 120 | 14.0 × 25.0 × 42.0 | 6.5 | 14.0 | B32656S1124+418 | T18 | 288 |
| | | | | 120 | 14.0 × 25.0 × 42.0 | 6.5 | 14.0 | B32656S1124+563 | T3 | 168 |
| 120 | 14.0 × 25.0 × 42.0 | | | 6.5 | 14.0 | B32656S1124+564 | T4 | 288 | | |
| 120 | 14.0 × 25.0 × 42.0 | | | 6.5 | 14.0 | B32656S1124+565 | T5 | 288 | | |

MOQ = Minimum Order Quantity, consisting of 4 packing units.
Further E series and intermediate capacitance values on request.

Composition of ordering code

+ = Capacitance tolerance code:

K = $\pm 10\%$

J = $\pm 5\%$



B32656S

Snubber (wound)

Ordering codes and packing units

| V_R | V_{RMS} $f \leq 1\text{kHz}$ | C_R | Max. dimensions $w \times h \times l$ | I_{RMS} 100 kHz | ESR_{typ} 100 kHz | Ordering code (composition see below) | Ter- minal | pcs./ MOQ |
|-------|-----------------------------------|-------|--|----------------------|------------------------|---|---------------|--------------|
| V DC | V AC | nF | mm | A | m Ω | | | |
| 1700 | 750 | 150 | 14.0 × 25.0 × 42.0 | 7.0 | 13.0 | B32656S1154+408 | T8 | 288 |
| | | 150 | 14.0 × 25.0 × 42.0 | 7.0 | 13.0 | B32656S1154+418 | T18 | 288 |
| | | 150 | 14.0 × 25.0 × 42.0 | 7.0 | 13.0 | B32656S1154+563 | T3 | 168 |
| | | 150 | 14.0 × 25.0 × 42.0 | 7.0 | 13.0 | B32656S1154+564 | T4 | 288 |
| | | 150 | 14.0 × 25.0 × 42.0 | 7.0 | 13.0 | B32656S1154+565 | T5 | 288 |
| | | 220 | 16.0 × 28.5 × 42.0 | 8.5 | 10.5 | B32656S1224+408 | T8 | 192 |
| | | 220 | 16.0 × 28.5 × 42.0 | 8.5 | 10.5 | B32656S1224+409 | T9 | 192 |
| | | 220 | 16.0 × 28.5 × 42.0 | 8.5 | 10.5 | B32656S1224+411 | T11 | 128 |
| | | 220 | 16.0 × 28.5 × 42.0 | 8.5 | 10.5 | B32656S1224+418 | T18 | 192 |
| | | 220 | 16.0 × 28.5 × 42.0 | 8.5 | 10.5 | B32656S1224+561 | T1 | 192 |
| | | 220 | 16.0 × 28.5 × 42.0 | 8.5 | 10.5 | B32656S1224+562 | T2 | 192 |
| | | 220 | 16.0 × 28.5 × 42.0 | 8.5 | 10.5 | B32656S1224+563 | T3 | 144 |
| | | 220 | 16.0 × 28.5 × 42.0 | 8.5 | 10.5 | B32656S1224+564 | T4 | 192 |
| | | 220 | 16.0 × 28.5 × 42.0 | 8.5 | 10.5 | B32656S1224+565 | T5 | 192 |
| | | 220 | 16.0 × 28.5 × 42.0 | 8.5 | 10.5 | B32656S1224+566 | T6 | 192 |
| | | 220 | 16.0 × 28.5 × 42.0 | 8.5 | 10.5 | B32656S1224+577 | T7 | 180 |
| | | 270 | 18.0 × 32.5 × 42.0 | 9.5 | 9.0 | B32656S1274+408 | T8 | 140 |
| | | 270 | 18.0 × 32.5 × 42.0 | 9.5 | 9.0 | B32656S1274+409 | T9 | 140 |
| | | 270 | 18.0 × 32.5 × 42.0 | 9.5 | 9.0 | B32656S1274+411 | T11 | 112 |
| | | 270 | 18.0 × 32.5 × 42.0 | 9.5 | 9.0 | B32656S1274+418 | T18 | 140 |
| | | 270 | 18.0 × 32.5 × 42.0 | 9.5 | 9.0 | B32656S1274+561 | T1 | 140 |
| | | 270 | 18.0 × 32.5 × 42.0 | 9.5 | 9.0 | B32656S1274+562 | T2 | 140 |
| | | 270 | 18.0 × 32.5 × 42.0 | 9.5 | 9.0 | B32656S1274+563 | T3 | 120 |
| | | 270 | 18.0 × 32.5 × 42.0 | 9.5 | 9.0 | B32656S1274+564 | T4 | 128 |
| | | 270 | 18.0 × 32.5 × 42.0 | 9.5 | 9.0 | B32656S1274+565 | T5 | 128 |
| | | 270 | 18.0 × 32.5 × 42.0 | 9.5 | 9.0 | B32656S1274+566 | T6 | 140 |
| | | 270 | 18.0 × 32.5 × 42.0 | 9.5 | 9.0 | B32656S1274+577 | T7 | 156 |

MOQ = Minimum Order Quantity, consisting of 4 packing units.
Further E series and intermediate capacitance values on request.

Composition of ordering code

+ = Capacitance tolerance code:

K = $\pm 10\%$

J = $\pm 5\%$

Ordering codes and packing units

| V_R | V_{RMS} $f \leq 1\text{kHz}$ | C_R | Max. dimensions $w \times h \times l$ | I_{RMS} 100 kHz | ESR_{typ} 100 kHz | Ordering code (composition see below) | Ter- minal | pcs./ MOQ | | |
|-------|-----------------------------------|-------|--|----------------------|------------------------|---|---------------|-----------------|-----|-----|
| V DC | V AC | nF | mm | A | m Ω | | | | | |
| 1700 | 750 | 330 | 20.0 × 39.5 × 42.0 | 12.0 | 8.0 | B32656S1334+408 | T8 | 96 | | |
| | | 330 | 20.0 × 39.5 × 42.0 | 12.0 | 8.0 | B32656S1334+409 | T9 | 96 | | |
| | | 330 | 20.0 × 39.5 × 42.0 | 12.0 | 8.0 | B32656S1334+410 | T10 | 120 | | |
| | | 330 | 20.0 × 39.5 × 42.0 | 12.0 | 8.0 | B32656S1334+411 | T11 | 96 | | |
| | | 330 | 20.0 × 39.5 × 42.0 | 12.0 | 8.0 | B32656S1334+418 | T18 | 96 | | |
| | | 330 | 20.0 × 39.5 × 42.0 | 12.0 | 8.0 | B32656S1334+561 | T1 | 96 | | |
| | | 330 | 20.0 × 39.5 × 42.0 | 12.0 | 8.0 | B32656S1334+562 | T2 | 96 | | |
| | | 330 | 20.0 × 39.5 × 42.0 | 12.0 | 8.0 | B32656S1334+563 | T3 | 104 | | |
| | | 330 | 20.0 × 39.5 × 42.0 | 12.0 | 8.0 | B32656S1334+564 | T4 | 96 | | |
| | | 330 | 20.0 × 39.5 × 42.0 | 12.0 | 8.0 | B32656S1334+565 | T5 | 96 | | |
| | | 330 | 20.0 × 39.5 × 42.0 | 12.0 | 8.0 | B32656S1334+566 | T6 | 96 | | |
| | | 330 | 20.0 × 39.5 × 42.0 | 12.0 | 8.0 | B32656S1334+577 | T7 | 144 | | |
| | | | | 390 | 28.0 × 37.0 × 42.0 | 13.5 | 7.0 | B32656S1394+408 | T8 | 108 |
| | | | | 390 | 28.0 × 37.0 × 42.0 | 13.5 | 7.0 | B32656S1394+409 | T9 | 108 |
| | | | | 390 | 28.0 × 37.0 × 42.0 | 13.5 | 7.0 | B32656S1394+410 | T10 | 80 |
| | | | | 390 | 28.0 × 37.0 × 42.0 | 13.5 | 7.0 | B32656S1394+411 | T11 | 72 |
| | | | | 390 | 28.0 × 37.0 × 42.0 | 13.5 | 7.0 | B32656S1394+418 | T18 | 108 |
| | | | | 390 | 28.0 × 37.0 × 42.0 | 13.5 | 7.0 | B32656S1394+561 | T1 | 108 |
| | | | | 390 | 28.0 × 37.0 × 42.0 | 13.5 | 7.0 | B32656S1394+562 | T2 | 108 |
| | | | | 390 | 28.0 × 37.0 × 42.0 | 13.5 | 7.0 | B32656S1394+563 | T3 | 96 |
| | | | | 390 | 28.0 × 37.0 × 42.0 | 13.5 | 7.0 | B32656S1394+566 | T6 | 108 |
| | | | | 390 | 28.0 × 37.0 × 42.0 | 13.5 | 7.0 | B32656S1394+577 | T7 | 96 |
| | | | | 470 | 28.0 × 37.0 × 42.0 | 14.5 | 6.0 | B32656S1474+408 | T8 | 108 |
| | | | | 470 | 28.0 × 37.0 × 42.0 | 14.5 | 6.0 | B32656S1474+409 | T9 | 108 |
| | | | | 470 | 28.0 × 37.0 × 42.0 | 14.5 | 6.0 | B32656S1474+410 | T10 | 72 |
| | | | | 470 | 28.0 × 37.0 × 42.0 | 14.5 | 6.0 | B32656S1474+411 | T11 | 108 |
| | | | | 470 | 28.0 × 37.0 × 42.0 | 14.5 | 6.0 | B32656S1474+418 | T18 | 108 |
| | | | | 470 | 28.0 × 37.0 × 42.0 | 14.5 | 6.0 | B32656S1474+561 | T1 | 108 |
| | | | | 470 | 28.0 × 37.0 × 42.0 | 14.5 | 6.0 | B32656S1474+562 | T2 | 108 |
| | | | | 470 | 28.0 × 37.0 × 42.0 | 14.5 | 6.0 | B32656S1474+563 | T3 | 96 |
| | | | | 470 | 28.0 × 37.0 × 42.0 | 14.5 | 6.0 | B32656S1474+566 | T6 | 108 |
| | | | | 470 | 28.0 × 37.0 × 42.0 | 14.5 | 6.0 | B32656S1474+577 | T7 | 96 |

MOQ = Minimum Order Quantity, consisting of 4 packing units.

Further E series and intermediate capacitance values on request.

Composition of ordering code

+ = Capacitance tolerance code:

K = $\pm 10\%$

J = $\pm 5\%$



B32656S

Snubber (wound)

Ordering codes and packing units

| V_R | V_{RMS} $f \leq 1\text{kHz}$ | C_R | Max. dimensions $w \times h \times l$ | I_{RMS} 100 kHz | ESR_{typ} 100 kHz | Ordering code (composition see below) | Ter- minal | pcs./ MOQ |
|-------|-----------------------------------|-------|--|----------------------|------------------------|---|---------------|--------------|
| V DC | V AC | nF | mm | A | m Ω | | | |
| 1700 | 750 | 560 | 30.0 × 45.0 × 42.0 | 16.5 | 5.5 | B32656S1564+408 | T8 | 48 |
| | | 560 | 30.0 × 45.0 × 42.0 | 16.5 | 5.5 | B32656S1564+409 | T9 | 48 |
| | | 560 | 30.0 × 45.0 × 42.0 | 16.5 | 5.5 | B32656S1564+410 | T10 | 80 |
| | | 560 | 30.0 × 45.0 × 42.0 | 16.5 | 5.5 | B32656S1564+411 | T11 | 64 |
| | | 560 | 30.0 × 45.0 × 42.0 | 16.5 | 5.5 | B32656S1564+418 | T18 | 48 |
| | | 560 | 30.0 × 45.0 × 42.0 | 16.5 | 5.5 | B32656S1564+561 | T1 | 48 |
| | | 560 | 30.0 × 45.0 × 42.0 | 16.5 | 5.5 | B32656S1564+562 | T2 | 48 |
| | | 560 | 30.0 × 45.0 × 42.0 | 16.5 | 5.5 | B32656S1564+563 | T3 | 96 |
| | | 560 | 30.0 × 45.0 × 42.0 | 16.5 | 5.5 | B32656S1564+566 | T6 | 48 |
| | | 560 | 30.0 × 45.0 × 42.0 | 16.5 | 5.5 | B32656S1564+577 | T7 | 96 |
| | | 680 | 30.0 × 45.0 × 42.0 | 18.0 | 5.0 | B32656S1684+408 | T8 | 48 |
| | | 680 | 30.0 × 45.0 × 42.0 | 18.0 | 5.0 | B32656S1684+409 | T9 | 48 |
| | | 680 | 30.0 × 45.0 × 42.0 | 18.0 | 5.0 | B32656S1684+410 | T10 | 80 |
| | | 680 | 30.0 × 45.0 × 42.0 | 18.0 | 5.0 | B32656S1684+411 | T11 | 64 |
| | | 680 | 30.0 × 45.0 × 42.0 | 18.0 | 5.0 | B32656S1684+418 | T18 | 48 |
| | | 680 | 30.0 × 45.0 × 42.0 | 18.0 | 5.0 | B32656S1684+561 | T1 | 48 |
| | | 680 | 30.0 × 45.0 × 42.0 | 18.0 | 5.0 | B32656S1684+562 | T2 | 48 |
| | | 680 | 30.0 × 45.0 × 42.0 | 18.0 | 5.0 | B32656S1684+563 | T3 | 96 |
| | | 680 | 30.0 × 45.0 × 42.0 | 18.0 | 5.0 | B32656S1684+566 | T6 | 48 |
| | | 680 | 30.0 × 45.0 × 42.0 | 18.0 | 5.0 | B32656S1684+577 | T7 | 96 |
| | | 820 | 33.0 × 48.0 × 43.0 | 20.0 | 4.0 | B32656S1824+408 | T8 | 84 |
| | | 820 | 33.0 × 48.0 × 43.0 | 20.0 | 4.0 | B32656S1824+409 | T9 | 84 |
| | | 820 | 33.0 × 48.0 × 43.0 | 20.0 | 4.0 | B32656S1824+410 | T10 | 60 |
| | | 820 | 33.0 × 48.0 × 43.0 | 20.0 | 4.0 | B32656S1824+411 | T11 | 56 |
| | | 820 | 33.0 × 48.0 × 43.0 | 20.0 | 4.0 | B32656S1824+418 | T18 | 84 |
| | | 820 | 33.0 × 48.0 × 43.0 | 20.0 | 4.0 | B32656S1824+561 | T1 | 84 |
| | | 820 | 33.0 × 48.0 × 43.0 | 20.0 | 4.0 | B32656S1824+562 | T2 | 84 |
| | | 820 | 33.0 × 48.0 × 43.0 | 20.0 | 4.0 | B32656S1824+563 | T3 | 64 |
| | | 820 | 33.0 × 48.0 × 43.0 | 20.0 | 4.0 | B32656S1824+566 | T6 | 84 |
| | | 820 | 33.0 × 48.0 × 43.0 | 20.0 | 4.0 | B32656S1824+577 | T7 | 84 |

MOQ = Minimum Order Quantity, consisting of 4 packing units.
Further E series and intermediate capacitance values on request.

Composition of ordering code

+ = Capacitance tolerance code:

K = $\pm 10\%$

J = $\pm 5\%$

Ordering codes and packing units

| V_R | V_{RMS} $f \leq 1\text{kHz}$ | C_R | Max. dimensions $w \times h \times l$ | I_{RMS} 100 kHz | ESR_{typ} 100 kHz | Ordering code (composition see below) | Ter- minal | pcs./ MOQ |
|-------|-----------------------------------|-------|--|----------------------|------------------------|---|---------------|--------------|
| V DC | V AC | nF | mm | A | m Ω | | | |
| 2000 | 800 | 68 | 14.0 × 25.0 × 42.0 | 6.0 | 17.0 | B32656S2683+408 | T8 | 288 |
| | | 68 | 14.0 × 25.0 × 42.0 | 6.0 | 17.0 | B32656S2683+418 | T18 | 288 |
| | | 68 | 14.0 × 25.0 × 42.0 | 6.0 | 17.0 | B32656S2683+563 | T3 | 168 |
| | | 68 | 14.0 × 25.0 × 42.0 | 6.0 | 17.0 | B32656S2683+564 | T4 | 288 |
| | | 68 | 14.0 × 25.0 × 42.0 | 6.0 | 17.0 | B32656S2683+565 | T5 | 288 |
| | | 100 | 14.0 × 25.0 × 42.0 | 6.5 | 15.0 | B32656S2104+408 | T8 | 288 |
| | | 100 | 14.0 × 25.0 × 42.0 | 6.5 | 15.0 | B32656S2104+418 | T18 | 288 |
| | | 100 | 14.0 × 25.0 × 42.0 | 6.5 | 15.0 | B32656S2104+563 | T3 | 168 |
| | | 100 | 14.0 × 25.0 × 42.0 | 6.5 | 15.0 | B32656S2104+564 | T4 | 288 |
| | | 100 | 14.0 × 25.0 × 42.0 | 6.5 | 15.0 | B32656S2104+565 | T5 | 288 |
| | | 120 | 16.0 × 28.5 × 42.0 | 7.0 | 14.0 | B32656S2124+408 | T8 | 192 |
| | | 120 | 16.0 × 28.5 × 42.0 | 7.0 | 14.0 | B32656S2124+409 | T9 | 192 |
| | | 120 | 16.0 × 28.5 × 42.0 | 7.0 | 14.0 | B32656S2124+411 | T11 | 128 |
| | | 120 | 16.0 × 28.5 × 42.0 | 7.0 | 14.0 | B32656S2124+418 | T18 | 192 |
| | | 120 | 16.0 × 28.5 × 42.0 | 7.0 | 14.0 | B32656S2124+561 | T1 | 192 |
| | | 120 | 16.0 × 28.5 × 42.0 | 7.0 | 14.0 | B32656S2124+562 | T2 | 192 |
| | | 120 | 16.0 × 28.5 × 42.0 | 7.0 | 14.0 | B32656S2124+563 | T3 | 144 |
| | | 120 | 16.0 × 28.5 × 42.0 | 7.0 | 14.0 | B32656S2124+564 | T4 | 192 |
| | | 120 | 16.0 × 28.5 × 42.0 | 7.0 | 14.0 | B32656S2124+565 | T5 | 192 |
| | | 120 | 16.0 × 28.5 × 42.0 | 7.0 | 14.0 | B32656S2124+566 | T6 | 192 |
| | | 120 | 16.0 × 28.5 × 42.0 | 7.0 | 14.0 | B32656S2124+577 | T7 | 180 |
| | | 150 | 18.0 × 32.5 × 42.0 | 8.0 | 13.0 | B32656S2154+408 | T8 | 140 |
| | | 150 | 18.0 × 32.5 × 42.0 | 8.0 | 13.0 | B32656S2154+409 | T9 | 140 |
| | | 150 | 18.0 × 32.5 × 42.0 | 8.0 | 13.0 | B32656S2154+411 | T11 | 112 |
| | | 150 | 18.0 × 32.5 × 42.0 | 8.0 | 13.0 | B32656S2154+418 | T18 | 140 |
| | | 150 | 18.0 × 32.5 × 42.0 | 8.0 | 13.0 | B32656S2154+561 | T1 | 140 |
| | | 150 | 18.0 × 32.5 × 42.0 | 8.0 | 13.0 | B32656S2154+562 | T2 | 140 |
| | | 150 | 18.0 × 32.5 × 42.0 | 8.0 | 13.0 | B32656S2154+563 | T3 | 120 |
| | | 150 | 18.0 × 32.5 × 42.0 | 8.0 | 13.0 | B32656S2154+564 | T4 | 128 |
| | | 150 | 18.0 × 32.5 × 42.0 | 8.0 | 13.0 | B32656S2154+565 | T5 | 128 |
| | | 150 | 18.0 × 32.5 × 42.0 | 8.0 | 13.0 | B32656S2154+566 | T6 | 140 |
| | | 150 | 18.0 × 32.5 × 42.0 | 8.0 | 13.0 | B32656S2154+577 | T7 | 156 |

MOQ = Minimum Order Quantity, consisting of 4 packing units.

Further E series and intermediate capacitance values on request.

Composition of ordering code

+ = Capacitance tolerance code:

K = $\pm 10\%$

J = $\pm 5\%$



B32656S

Snubber (wound)

Ordering codes and packing units

| V_R | V_{RMS} $f \leq 1\text{kHz}$ | C_R | Max. dimensions $w \times h \times l$ | I_{RMS} 100 kHz | ESR_{typ} 100 kHz | Ordering code (composition see below) | Ter- minal | pcs./ MOQ | | | |
|-------|-----------------------------------|--------------------|--|----------------------|------------------------|---|-----------------|--------------|-----------------|----|-----|
| V DC | V AC | nF | mm | A | m Ω | | | | | | |
| 2000 | 800 | 220 | 20.0 × 39.5 × 42.0 | 11.0 | 9.0 | B32656S2224+408 | T8 | 96 | | | |
| | | 220 | 20.0 × 39.5 × 42.0 | 11.0 | 9.0 | B32656S2224+409 | T9 | 96 | | | |
| | | 220 | 20.0 × 39.5 × 42.0 | 11.0 | 9.0 | B32656S2224+410 | T10 | 120 | | | |
| | | 220 | 20.0 × 39.5 × 42.0 | 11.0 | 9.0 | B32656S2224+411 | T11 | 96 | | | |
| | | 220 | 20.0 × 39.5 × 42.0 | 11.0 | 9.0 | B32656S2224+418 | T18 | 96 | | | |
| | | 220 | 20.0 × 39.5 × 42.0 | 11.0 | 9.0 | B32656S2224+561 | T1 | 96 | | | |
| | | 220 | 20.0 × 39.5 × 42.0 | 11.0 | 9.0 | B32656S2224+562 | T2 | 96 | | | |
| | | 220 | 20.0 × 39.5 × 42.0 | 11.0 | 9.0 | B32656S2224+563 | T3 | 104 | | | |
| | | 220 | 20.0 × 39.5 × 42.0 | 11.0 | 9.0 | B32656S2224+564 | T4 | 96 | | | |
| | | 220 | 20.0 × 39.5 × 42.0 | 11.0 | 9.0 | B32656S2224+565 | T5 | 96 | | | |
| | | 220 | 20.0 × 39.5 × 42.0 | 11.0 | 9.0 | B32656S2224+566 | T6 | 96 | | | |
| | | 220 | 20.0 × 39.5 × 42.0 | 11.0 | 9.0 | B32656S2224+577 | T7 | 144 | | | |
| | 270 | 800 | 270 | 28.0 × 37.0 × 42.0 | 12.5 | 8.0 | B32656S2274+408 | T8 | 108 | | |
| | | | 270 | 28.0 × 37.0 × 42.0 | 12.5 | 8.0 | B32656S2274+409 | T9 | 108 | | |
| | | | 270 | 28.0 × 37.0 × 42.0 | 12.5 | 8.0 | B32656S2274+410 | T10 | 80 | | |
| | | | 270 | 28.0 × 37.0 × 42.0 | 12.5 | 8.0 | B32656S2274+411 | T11 | 72 | | |
| | | | 270 | 28.0 × 37.0 × 42.0 | 12.5 | 8.0 | B32656S2274+418 | T18 | 108 | | |
| | | | 270 | 28.0 × 37.0 × 42.0 | 12.5 | 8.0 | B32656S2274+561 | T1 | 108 | | |
| | | | 270 | 28.0 × 37.0 × 42.0 | 12.5 | 8.0 | B32656S2274+562 | T2 | 108 | | |
| | | | 270 | 28.0 × 37.0 × 42.0 | 12.5 | 8.0 | B32656S2274+563 | T3 | 96 | | |
| | | | 270 | 28.0 × 37.0 × 42.0 | 12.5 | 8.0 | B32656S2274+566 | T6 | 108 | | |
| | | | 270 | 28.0 × 37.0 × 42.0 | 12.5 | 8.0 | B32656S2274+577 | T7 | 96 | | |
| | | | 330 | 800 | 330 | 28.0 × 37.0 × 42.0 | 14.0 | 6.5 | B32656S2334+408 | T8 | 108 |
| | | | | | 330 | 28.0 × 37.0 × 42.0 | 14.0 | 6.5 | B32656S2334+409 | T9 | 108 |
| | 330 | 28.0 × 37.0 × 42.0 | | | 14.0 | 6.5 | B32656S2334+410 | T10 | 80 | | |
| | 330 | 28.0 × 37.0 × 42.0 | | | 14.0 | 6.5 | B32656S2334+411 | T11 | 72 | | |
| | 330 | 28.0 × 37.0 × 42.0 | | | 14.0 | 6.5 | B32656S2334+418 | T18 | 108 | | |
| | 330 | 28.0 × 37.0 × 42.0 | | | 14.0 | 6.5 | B32656S2334+561 | T1 | 108 | | |
| | 330 | 28.0 × 37.0 × 42.0 | | | 14.0 | 6.5 | B32656S2334+562 | T2 | 108 | | |
| | 330 | 28.0 × 37.0 × 42.0 | | | 14.0 | 6.5 | B32656S2334+563 | T3 | 96 | | |
| | 330 | 28.0 × 37.0 × 42.0 | | | 14.0 | 6.5 | B32656S2334+566 | T6 | 108 | | |
| | 330 | 28.0 × 37.0 × 42.0 | | | 14.0 | 6.5 | B32656S2334+577 | T7 | 96 | | |

MOQ = Minimum Order Quantity, consisting of 4 packing units.
Further E series and intermediate capacitance values on request.

Composition of ordering code

+ = Capacitance tolerance code:

K = $\pm 10\%$

J = $\pm 5\%$

Ordering codes and packing units

| V_R | V_{RMS} $f \leq 1\text{kHz}$ | C_R | Max. dimensions $w \times h \times l$ | I_{RMS} 100 kHz | ESR_{typ} 100 kHz | Ordering code (composition see below) | Ter- minal | pcs./ MOQ |
|-------|-----------------------------------|-------|--|----------------------|------------------------|---|---------------|--------------|
| V DC | V AC | nF | mm | A | m Ω | | | |
| 2000 | 800 | 390 | 30.0 × 45.0 × 42.0 | 15.0 | 6.5 | B32656S2394+408 | T8 | 48 |
| | | 390 | 30.0 × 45.0 × 42.0 | 15.0 | 6.5 | B32656S2394+409 | T9 | 48 |
| | | 390 | 30.0 × 45.0 × 42.0 | 15.0 | 6.5 | B32656S2394+410 | T10 | 80 |
| | | 390 | 30.0 × 45.0 × 42.0 | 15.0 | 6.5 | B32656S2394+411 | T11 | 64 |
| | | 390 | 30.0 × 45.0 × 42.0 | 15.0 | 6.5 | B32656S2394+418 | T18 | 48 |
| | | 390 | 30.0 × 45.0 × 42.0 | 15.0 | 6.5 | B32656S2394+561 | T1 | 48 |
| | | 390 | 30.0 × 45.0 × 42.0 | 15.0 | 6.5 | B32656S2394+562 | T2 | 48 |
| | | 390 | 30.0 × 45.0 × 42.0 | 15.0 | 6.5 | B32656S2394+563 | T3 | 96 |
| | | 390 | 30.0 × 45.0 × 42.0 | 15.0 | 6.5 | B32656S2394+566 | T6 | 48 |
| | | 390 | 30.0 × 45.0 × 42.0 | 15.0 | 6.5 | B32656S2394+577 | T7 | 96 |
| | | 470 | 30.0 × 45.0 × 42.0 | 17.0 | 5.5 | B32656S2474+408 | T8 | 48 |
| | | 470 | 30.0 × 45.0 × 42.0 | 17.0 | 5.5 | B32656S2474+409 | T9 | 48 |
| | | 470 | 30.0 × 45.0 × 42.0 | 17.0 | 5.5 | B32656S2474+410 | T10 | 80 |
| | | 470 | 30.0 × 45.0 × 42.0 | 17.0 | 5.5 | B32656S2474+411 | T11 | 64 |
| | | 470 | 30.0 × 45.0 × 42.0 | 17.0 | 5.5 | B32656S2474+418 | T18 | 48 |
| | | 470 | 30.0 × 45.0 × 42.0 | 17.0 | 5.5 | B32656S2474+561 | T1 | 48 |
| | | 470 | 30.0 × 45.0 × 42.0 | 17.0 | 5.5 | B32656S2474+562 | T2 | 48 |
| | | 470 | 30.0 × 45.0 × 42.0 | 17.0 | 5.5 | B32656S2474+563 | T3 | 96 |
| | | 470 | 30.0 × 45.0 × 42.0 | 17.0 | 5.5 | B32656S2474+566 | T6 | 48 |
| | | 470 | 30.0 × 45.0 × 42.0 | 17.0 | 5.5 | B32656S2474+577 | T7 | 96 |
| | | 560 | 33.0 × 48.0 × 43.0 | 19.0 | 4.5 | B32656S2564+408 | T8 | 84 |
| | | 560 | 33.0 × 48.0 × 43.0 | 19.0 | 4.5 | B32656S2564+409 | T9 | 84 |
| | | 560 | 33.0 × 48.0 × 43.0 | 19.0 | 4.5 | B32656S2564+410 | T10 | 60 |
| | | 560 | 33.0 × 48.0 × 43.0 | 19.0 | 4.5 | B32656S2564+411 | T11 | 56 |
| | | 560 | 33.0 × 48.0 × 43.0 | 19.0 | 4.5 | B32656S2564+418 | T18 | 84 |
| | | 560 | 33.0 × 48.0 × 43.0 | 19.0 | 4.5 | B32656S2564+561 | T1 | 84 |
| | | 560 | 33.0 × 48.0 × 43.0 | 19.0 | 4.5 | B32656S2564+562 | T2 | 84 |
| | | 560 | 33.0 × 48.0 × 43.0 | 19.0 | 4.5 | B32656S2564+563 | T3 | 64 |
| | | 560 | 33.0 × 48.0 × 43.0 | 19.0 | 4.5 | B32656S2564+566 | T6 | 84 |
| | | 560 | 33.0 × 48.0 × 43.0 | 19.0 | 4.5 | B32656S2564+577 | T7 | 84 |

MOQ = Minimum Order Quantity, consisting of 4 packing units.

Further E series and intermediate capacitance values on request.

Composition of ordering code

+ = Capacitance tolerance code:

K = $\pm 10\%$

J = $\pm 5\%$

B32658S
Snubber (wound)
Ordering codes and packing units

| V_R | V_{RMS} $f \leq 1\text{kHz}$ | C_R | Max. dimensions $w \times h \times l$ | I_{RMS} 100 kHz | ESR_{typ} 100 kHz | Ordering code (composition see below) | Ter- minal | pcs./ MOQ |
|-------|-----------------------------------|-------|--|----------------------|------------------------|---|---------------|--------------|
| V DC | V AC | nF | mm | A | m Ω | | | |
| 850 | 450 | 1500 | 22.5 × 33.0 × 57.5 | 12.0 | 7.0 | B32658S8155+414 | T14 | 88 |
| | | 1500 | 22.5 × 33.0 × 57.5 | 12.0 | 7.0 | B32658S8155+416 | T16 | 88 |
| | | 1800 | 22.5 × 33.0 × 57.5 | 13.0 | 6.5 | B32658S8185+414 | T14 | 88 |
| | | 1800 | 22.5 × 33.0 × 57.5 | 13.0 | 6.5 | B32658S8185+416 | T16 | 88 |
| | | 2200 | 22.5 × 33.0 × 57.5 | 14.5 | 5.5 | B32658S8225+414 | T14 | 88 |
| | | 2200 | 22.5 × 33.0 × 57.5 | 14.5 | 5.5 | B32658S8225+416 | T16 | 88 |
| | | 2700 | 27.0 × 39.5 × 57.5 | 18.0 | 5.0 | B32658S8275+414 | T14 | 72 |
| | | 2700 | 27.0 × 39.5 × 57.5 | 18.0 | 5.0 | B32658S8275+415 | T15 | 72 |
| | | 2700 | 27.0 × 39.5 × 57.5 | 18.0 | 5.0 | B32658S8275+416 | T16 | 72 |
| | | 2700 | 27.0 × 39.5 × 57.5 | 18.0 | 5.0 | B32658S8275+417 | T17 | 72 |
| | | 3000 | 27.0 × 39.5 × 57.5 | 19.0 | 4.5 | B32658S8305+414 | T14 | 72 |
| | | 3000 | 27.0 × 39.5 × 57.5 | 19.0 | 4.5 | B32658S8305+415 | T15 | 72 |
| | | 3000 | 27.0 × 39.5 × 57.5 | 19.0 | 4.5 | B32658S8305+416 | T16 | 72 |
| | | 3000 | 27.0 × 39.5 × 57.5 | 19.0 | 4.5 | B32658S8305+417 | T17 | 72 |
| | | 3300 | 27.0 × 39.5 × 57.5 | 19.0 | 4.5 | B32658S8335K414 | T14 | 72 |
| | | 3300 | 27.0 × 39.5 × 57.5 | 19.0 | 4.5 | B32658S8335K415 | T15 | 72 |
| | | 3300 | 27.0 × 39.5 × 57.5 | 19.0 | 4.5 | B32658S8335K416 | T16 | 72 |
| | | 3300 | 27.0 × 39.5 × 57.5 | 19.0 | 4.5 | B32658S8335K417 | T17 | 72 |
| | | 4000 | 30.0 × 45.0 × 57.5 | 21.0 | 4.0 | B32658S8405+414 | T14 | 64 |
| | | 4000 | 30.0 × 45.0 × 57.5 | 21.0 | 4.0 | B32658S8405+415 | T15 | 64 |
| | | 4000 | 30.0 × 45.0 × 57.5 | 21.0 | 4.0 | B32658S8405+416 | T16 | 64 |
| | | 4000 | 30.0 × 45.0 × 57.5 | 21.0 | 4.0 | B32658S8405+417 | T17 | 64 |
| | | 4500 | 30.0 × 45.0 × 57.5 | 22.0 | 3.7 | B32658S8455+414 | T14 | 64 |
| | | 4500 | 30.0 × 45.0 × 57.5 | 22.0 | 3.7 | B32658S8455+415 | T15 | 64 |
| | | 4500 | 30.0 × 45.0 × 57.5 | 22.0 | 3.7 | B32658S8455+416 | T16 | 64 |
| | | 4500 | 30.0 × 45.0 × 57.5 | 22.0 | 3.7 | B32658S8455+417 | T17 | 64 |
| | | 4700 | 35.0 × 50.0 × 57.5 | 23.0 | 3.5 | B32658S8475+414 | T14 | 56 |
| | | 4700 | 35.0 × 50.0 × 57.5 | 23.0 | 3.5 | B32658S8475+415 | T15 | 56 |
| | | 4700 | 35.0 × 50.0 × 57.5 | 23.0 | 3.5 | B32658S8475+416 | T16 | 56 |
| | | 4700 | 35.0 × 50.0 × 57.5 | 23.0 | 3.5 | B32658S8475+417 | T17 | 56 |

MOQ = Minimum Order Quantity, consisting of 4 packing units.
Further E series and intermediate capacitance values on request.

Composition of ordering code

+ = Capacitance tolerance code:

K = $\pm 10\%$

J = $\pm 5\%$

Ordering codes and packing units

| V_R | V_{RMS} $f \leq 1\text{kHz}$ | C_R | Max. dimensions $w \times h \times l$ | I_{RMS} 100 kHz | ESR_{typ} 100 kHz | Ordering code (composition see below) | Ter- minal | pcs./ MOQ |
|-------|-----------------------------------|-------|--|----------------------|------------------------|---|---------------|--------------|
| V DC | V AC | nF | mm | A | m Ω | | | |
| 850 | 450 | 5000 | 35.0 × 50.0 × 57.5 | 24.0 | 3.2 | B32658S8505+414 | T14 | 56 |
| | | 5000 | 35.0 × 50.0 × 57.5 | 24.0 | 3.2 | B32658S8505+415 | T15 | 56 |
| | | 5000 | 35.0 × 50.0 × 57.5 | 24.0 | 3.2 | B32658S8505+416 | T16 | 56 |
| | | 5000 | 35.0 × 50.0 × 57.5 | 24.0 | 3.2 | B32658S8505+417 | T17 | 56 |
| | | 5600 | 35.0 × 50.0 × 57.5 | 27.0 | 2.8 | B32658S8565+414 | T14 | 56 |
| | | 5600 | 35.0 × 50.0 × 57.5 | 27.0 | 2.8 | B32658S8565+415 | T15 | 56 |
| | | 5600 | 35.0 × 50.0 × 57.5 | 27.0 | 2.8 | B32658S8565+416 | T16 | 56 |
| | | 5600 | 35.0 × 50.0 × 57.5 | 27.0 | 2.8 | B32658S8565+417 | T17 | 56 |
| 1000 | 480 | 1000 | 22.5 × 33.0 × 57.5 | 11.0 | 8.0 | B32658S0105+414 | T14 | 88 |
| | | 1000 | 22.5 × 33.0 × 57.5 | 11.0 | 8.0 | B32658S0105+416 | T16 | 88 |
| | | 1500 | 22.5 × 33.0 × 57.5 | 13.5 | 6.5 | B32658S0155+414 | T14 | 88 |
| | | 1500 | 22.5 × 33.0 × 57.5 | 13.5 | 6.5 | B32658S0155+416 | T16 | 88 |
| | | 1800 | 27.0 × 39.5 × 57.5 | 15.5 | 6.0 | B32658S0185+414 | T14 | 72 |
| | | 1800 | 27.0 × 39.5 × 57.5 | 15.5 | 6.0 | B32658S0185+415 | T15 | 72 |
| | | 1800 | 27.0 × 39.5 × 57.5 | 15.5 | 6.0 | B32658S0185+416 | T16 | 72 |
| | | 1800 | 27.0 × 39.5 × 57.5 | 15.5 | 6.0 | B32658S0185+417 | T17 | 72 |
| | | 2200 | 27.0 × 39.5 × 57.5 | 17.0 | 5.0 | B32658S0225+414 | T14 | 72 |
| | | 2200 | 27.0 × 39.5 × 57.5 | 17.0 | 5.0 | B32658S0225+415 | T15 | 72 |
| | | 2200 | 27.0 × 39.5 × 57.5 | 17.0 | 5.0 | B32658S0225+416 | T16 | 72 |
| | | 2200 | 27.0 × 39.5 × 57.5 | 17.0 | 5.0 | B32658S0225+417 | T17 | 72 |
| | | 2700 | 30.0 × 45.0 × 57.5 | 20.0 | 4.5 | B32658S0275+414 | T14 | 64 |
| | | 2700 | 30.0 × 45.0 × 57.5 | 20.0 | 4.5 | B32658S0275+415 | T15 | 64 |
| | | 2700 | 30.0 × 45.0 × 57.5 | 20.0 | 4.5 | B32658S0275+416 | T16 | 64 |
| | | 2700 | 30.0 × 45.0 × 57.5 | 20.0 | 4.5 | B32658S0275+417 | T17 | 64 |
| | | 3000 | 30.0 × 45.0 × 57.5 | 21.0 | 4.0 | B32658S0305+414 | T14 | 64 |
| | | 3000 | 30.0 × 45.0 × 57.5 | 21.0 | 4.0 | B32658S0305+415 | T15 | 64 |
| | | 3000 | 30.0 × 45.0 × 57.5 | 21.0 | 4.0 | B32658S0305+416 | T16 | 64 |
| | | 3000 | 30.0 × 45.0 × 57.5 | 21.0 | 4.0 | B32658S0305+417 | T17 | 64 |
| | | 3300 | 35.0 × 50.0 × 57.5 | 22.0 | 4.0 | B32658S0335+414 | T14 | 56 |
| | | 3300 | 35.0 × 50.0 × 57.5 | 22.0 | 4.0 | B32658S0335+415 | T15 | 56 |
| | | 3300 | 35.0 × 50.0 × 57.5 | 22.0 | 4.0 | B32658S0335+416 | T16 | 56 |
| | | 3300 | 35.0 × 50.0 × 57.5 | 22.0 | 4.0 | B32658S0335+417 | T17 | 56 |

MOQ = Minimum Order Quantity, consisting of 4 packing units.

Further E series and intermediate capacitance values on request.

Composition of ordering code

+ = Capacitance tolerance code:

K = $\pm 10\%$

J = $\pm 5\%$

B32658S
Snubber (wound)
Ordering codes and packing units

| V_R | V_{RMS} $f \leq 1\text{kHz}$ | C_R | Max. dimensions $w \times h \times l$ | I_{RMS} 100 kHz | ESR_{typ} 100 kHz | Ordering code (composition see below) | Ter- minal | pcs./ MOQ |
|-------|-----------------------------------|-------|--|----------------------|------------------------|---|---------------|--------------|
| V DC | V AC | nF | mm | A | m Ω | | | |
| 1000 | 480 | 4000 | 35.0 × 50.0 × 57.5 | 24.0 | 3.5 | B32658S0405+414 | T14 | 56 |
| | | 4000 | 35.0 × 50.0 × 57.5 | 24.0 | 3.5 | B32658S0405+415 | T15 | 56 |
| | | 4000 | 35.0 × 50.0 × 57.5 | 24.0 | 3.5 | B32658S0405+416 | T16 | 56 |
| | | 4000 | 35.0 × 50.0 × 57.5 | 24.0 | 3.5 | B32658S0405+417 | T17 | 56 |
| | | 4200 | 35.0 × 50.0 × 57.5 | 24.0 | 3.5 | B32658S0425+414 | T14 | 56 |
| | | 4200 | 35.0 × 50.0 × 57.5 | 24.0 | 3.5 | B32658S0425+415 | T15 | 56 |
| | | 4200 | 35.0 × 50.0 × 57.5 | 24.0 | 3.5 | B32658S0425+416 | T16 | 56 |
| | | 4200 | 35.0 × 50.0 × 57.5 | 24.0 | 3.5 | B32658S0425+417 | T17 | 56 |
| 1250 | 500 | 820 | 22.5 × 33.0 × 57.5 | 11.5 | 7.5 | B32658S7824+414 | T14 | 88 |
| | | 820 | 22.5 × 33.0 × 57.5 | 11.5 | 7.5 | B32658S7824+416 | T16 | 88 |
| | | 1000 | 22.5 × 33.0 × 57.5 | 12.5 | 7.0 | B32658S7105+414 | T14 | 88 |
| | | 1000 | 22.5 × 33.0 × 57.5 | 12.5 | 7.0 | B32658S7105+416 | T16 | 88 |
| | | 1200 | 27.0 × 39.5 × 57.5 | 14.5 | 7.0 | B32658S7125+414 | T14 | 72 |
| | | 1200 | 27.0 × 39.5 × 57.5 | 14.5 | 7.0 | B32658S7125+415 | T15 | 72 |
| | | 1200 | 27.0 × 39.5 × 57.5 | 14.5 | 7.0 | B32658S7125+416 | T16 | 72 |
| | | 1200 | 27.0 × 39.5 × 57.5 | 14.5 | 7.0 | B32658S7125+417 | T17 | 72 |
| | | 1500 | 27.0 × 39.5 × 57.5 | 15.0 | 6.5 | B32658S7155+414 | T14 | 72 |
| | | 1500 | 27.0 × 39.5 × 57.5 | 15.0 | 6.5 | B32658S7155+415 | T15 | 72 |
| | | 1500 | 27.0 × 39.5 × 57.5 | 15.0 | 6.5 | B32658S7155+416 | T16 | 72 |
| | | 1500 | 27.0 × 39.5 × 57.5 | 15.0 | 6.5 | B32658S7155+417 | T17 | 72 |
| | | 1800 | 27.0 × 39.5 × 57.5 | 16.5 | 5.5 | B32658S7185+414 | T14 | 72 |
| | | 1800 | 27.0 × 39.5 × 57.5 | 16.5 | 5.5 | B32658S7185+415 | T15 | 72 |
| | | 1800 | 27.0 × 39.5 × 57.5 | 16.5 | 5.5 | B32658S7185+416 | T16 | 72 |
| | | 1800 | 27.0 × 39.5 × 57.5 | 16.5 | 5.5 | B32658S7185+417 | T17 | 72 |
| | | 2200 | 30.0 × 45.0 × 57.5 | 19.0 | 4.7 | B32658S7225+414 | T14 | 64 |
| | | 2200 | 30.0 × 45.0 × 57.5 | 19.0 | 4.7 | B32658S7225+415 | T15 | 64 |
| | | 2200 | 30.0 × 45.0 × 57.5 | 19.0 | 4.7 | B32658S7225+416 | T16 | 64 |
| | | 2200 | 30.0 × 45.0 × 57.5 | 19.0 | 4.7 | B32658S7225+417 | T17 | 64 |
| | | 2700 | 35.0 × 50.0 × 57.5 | 22.0 | 4.0 | B32658S7275+414 | T14 | 56 |
| | | 2700 | 35.0 × 50.0 × 57.5 | 22.0 | 4.0 | B32658S7275+415 | T15 | 56 |
| | | 2700 | 35.0 × 50.0 × 57.5 | 22.0 | 4.0 | B32658S7275+416 | T16 | 56 |
| | | 2700 | 35.0 × 50.0 × 57.5 | 22.0 | 4.0 | B32658S7275+417 | T17 | 56 |

MOQ = Minimum Order Quantity, consisting of 4 packing units.
Further E series and intermediate capacitance values on request.

Composition of ordering code

+ = Capacitance tolerance code:

K = $\pm 10\%$

J = $\pm 5\%$

Ordering codes and packing units

| V_R | V_{RMS} $f \leq 1\text{kHz}$ | C_R | Max. dimensions $w \times h \times l$ | I_{RMS} 100 kHz | ESR_{typ} 100 kHz | Ordering code (composition see below) | Ter- minal | pcs./ MOQ |
|-------|-----------------------------------|-------|--|----------------------|------------------------|---|---------------|--------------|
| V DC | V AC | nF | mm | A | m Ω | | | |
| 1250 | 500 | 3000 | 35.0 × 50.0 × 57.5 | 24.0 | 3.5 | B32658S7305+414 | T14 | 56 |
| | | 3000 | 35.0 × 50.0 × 57.5 | 24.0 | 3.5 | B32658S7305+415 | T15 | 56 |
| | | 3000 | 35.0 × 50.0 × 57.5 | 24.0 | 3.5 | B32658S7305+416 | T16 | 56 |
| | | 3000 | 35.0 × 50.0 × 57.5 | 24.0 | 3.5 | B32658S7305+417 | T17 | 56 |
| 1700 | 750 | 470 | 22.5 × 33.0 × 57.5 | 11.5 | 9.0 | B32658S1474+414 | T14 | 88 |
| | | 470 | 22.5 × 33.0 × 57.5 | 11.5 | 9.0 | B32658S1474+416 | T16 | 88 |
| | | 680 | 27.0 × 39.5 × 57.5 | 14.5 | 7.5 | B32658S1684+414 | T14 | 72 |
| | | 680 | 27.0 × 39.5 × 57.5 | 14.5 | 7.5 | B32658S1684+415 | T15 | 72 |
| | | 680 | 27.0 × 39.5 × 57.5 | 14.5 | 7.5 | B32658S1684+416 | T16 | 72 |
| | | 680 | 27.0 × 39.5 × 57.5 | 14.5 | 7.5 | B32658S1684+417 | T17 | 72 |
| | | 1000 | 30.0 × 45.0 × 57.5 | 16.5 | 6.7 | B32658S1105+414 | T14 | 64 |
| | | 1000 | 30.0 × 45.0 × 57.5 | 16.5 | 6.7 | B32658S1105+415 | T15 | 64 |
| | | 1000 | 30.0 × 45.0 × 57.5 | 16.5 | 6.7 | B32658S1105+416 | T16 | 64 |
| | | 1000 | 30.0 × 45.0 × 57.5 | 16.5 | 6.7 | B32658S1105+417 | T17 | 64 |
| | | 1200 | 35.0 × 50.0 × 57.5 | 18.5 | 6.2 | B32658S1125+414 | T14 | 56 |
| | | 1200 | 35.0 × 50.0 × 57.5 | 18.5 | 6.2 | B32658S1125+415 | T15 | 56 |
| | | 1200 | 35.0 × 50.0 × 57.5 | 18.5 | 6.2 | B32658S1125+416 | T16 | 56 |
| | | 1200 | 35.0 × 50.0 × 57.5 | 18.5 | 6.2 | B32658S1125+417 | T17 | 56 |
| | | 1400 | 35.0 × 50.0 × 57.5 | 20.0 | 5.5 | B32658S1145+414 | T14 | 56 |
| | | 1400 | 35.0 × 50.0 × 57.5 | 20.0 | 5.5 | B32658S1145+415 | T15 | 56 |
| 1400 | 35.0 × 50.0 × 57.5 | 20.0 | 5.5 | B32658S1145+416 | T16 | 56 | | |
| 1400 | 35.0 × 50.0 × 57.5 | 20.0 | 5.5 | B32658S1145+417 | T17 | 56 | | |
| 2000 | 800 | 330 | 22.5 × 33.0 × 57.5 | 11.5 | 9.0 | B32658S2334+414 | T14 | 88 |
| | | 330 | 22.5 × 33.0 × 57.5 | 11.5 | 9.0 | B32658S2334+416 | T16 | 88 |
| | | 470 | 27.0 × 39.5 × 57.5 | 14.0 | 8.0 | B32658S2474+414 | T14 | 72 |
| | | 470 | 27.0 × 39.5 × 57.5 | 14.0 | 8.0 | B32658S2474+415 | T15 | 72 |
| | | 470 | 27.0 × 39.5 × 57.5 | 14.0 | 8.0 | B32658S2474+416 | T16 | 72 |
| | | 470 | 27.0 × 39.5 × 57.5 | 14.0 | 8.0 | B32658S2474+417 | T17 | 72 |
| | | 680 | 30.0 × 45.0 × 57.5 | 16.5 | 7.0 | B32658S2684+414 | T14 | 64 |

MOQ = Minimum Order Quantity, consisting of 4 packing units.

Further E series and intermediate capacitance values on request.

Composition of ordering code

+ = Capacitance tolerance code:

K = $\pm 10\%$

J = $\pm 5\%$



B32658S

Snubber (wound)

Ordering codes and packing units

| V_R | V_{RMS} $f \leq 1\text{kHz}$ | C_R | Max. dimensions $w \times h \times l$ | I_{RMS} 100 kHz | ESR_{typ} 100 kHz | Ordering code (composition see below) | Ter- minal | pcs./ MOQ |
|-------|-----------------------------------|--------------------|--|----------------------|------------------------|---|---------------|--------------|
| V DC | V AC | nF | mm | A | m Ω | | | |
| 2000 | 800 | 680 | 30.0 × 45.0 × 57.5 | 16.5 | 7.0 | B32658S2684+415 | T15 | 64 |
| | | 680 | 30.0 × 45.0 × 57.5 | 16.5 | 7.0 | B32658S2684+416 | T16 | 64 |
| | | 680 | 30.0 × 45.0 × 57.5 | 16.5 | 7.0 | B32658S2684+417 | T17 | 64 |
| | | 820 | 35.0 × 50.0 × 57.5 | 18.0 | 6.5 | B32658S2824+414 | T14 | 56 |
| | | 820 | 35.0 × 50.0 × 57.5 | 18.0 | 6.5 | B32658S2824+415 | T15 | 56 |
| | | 820 | 35.0 × 50.0 × 57.5 | 18.0 | 6.5 | B32658S2824+416 | T16 | 56 |
| | | 820 | 35.0 × 50.0 × 57.5 | 18.0 | 6.5 | B32658S2824+417 | T17 | 56 |
| | | 900 | 35.0 × 50.0 × 57.5 | 19.0 | 6.0 | B32658S2904+414 | T14 | 56 |
| | | 900 | 35.0 × 50.0 × 57.5 | 19.0 | 6.0 | B32658S2904+415 | T15 | 56 |
| | 900 | 35.0 × 50.0 × 57.5 | 19.0 | 6.0 | B32658S2904+416 | T16 | 56 | |
| | 900 | 35.0 × 50.0 × 57.5 | 19.0 | 6.0 | B32658S2904+417 | T17 | 56 | |

MOQ = Minimum Order Quantity, consisting of 4 packing units.

Further E series and intermediate capacitance values on request.

Composition of ordering code

+ = Capacitance tolerance code:

K = $\pm 10\%$

J = $\pm 5\%$



Technical data

Reference standard: IEC 60384-16:2005 and AEC-Q200D. All data given at $T = 20\text{ °C}$, unless otherwise specified.

| | | | |
|--|---|--|--|
| Operating temperature range | Max. operating temperature $T_{op,max}$ +110 °C | | |
| | Upper category temperature T_{max} +100 °C | | |
| | Lower category temperature T_{min} -55 °C | | |
| | Rated temperature T_R +85 °C | | |
| Dissipation factor $\tan \delta$ (in 10^{-3}) at 20 °C (upper limit values) | at | $C_R \leq 0.1\ \mu\text{F}$ | $0.1\ \mu\text{F} < C_R \leq 1\ \mu\text{F}$ |
| | 1 kHz | — | 0.5 |
| | 10 kHz | — | 0.8 |
| | 100 kHz | 5.0 | — |
| Insulation resistance R_{ins} or time constant $\tau = C_R \cdot R_{ins}$ at 20 °C, rel. humidity $\leq 65\%$ (minimum as-delivered values) | $C_R \leq 0.33\ \mu\text{F}$ | | $C_R > 0.33\ \mu\text{F}$ |
| | 100 G Ω | | 30000 s |
| DC test voltage | $1.6 \cdot V_R$, 2 s | | |
| Category voltage V_C (continuous operation with V_{DC} or V_{AC} at $f \leq 1\text{ kHz}$) | T_{op} (°C) | DC voltage derating | AC voltage derating |
| | $T_{op} \leq 85$ $85 < T_{op} \leq 110$ | $V_C = V_R$ $V_C = V_R \cdot (165 - T_{op})/80$ | $V_{C,RMS} = V_{RMS}$ $V_{C,RMS} = V_{RMS} \cdot (165 - T_{op})/80$ |
| Operating voltage V_{op} for short operating periods (V_{DC} or V_{AC} at $f \leq 1\text{ kHz}$) | T_{op} (°C) | DC voltage (max. hours) | AC voltage (max. hours) |
| | $T_{op} \leq 85$ $85 < T_{op} \leq 100$ | $V_{op} = 1.25 \cdot V_C$ (2000 h) $V_{op} = 1.25 \cdot V_C$ (1000 h) | $V_{op} = 1.0 \cdot V_{C,RMS}$ (2000 h) $V_{op} = 1.0 \cdot V_{C,RMS}$ (1000 h) |
| Biased humidity Limit values after biased humidity test | 1000 h / 40 °C / 93% relative humidity with $V_{R,DC}$ | | |
| | Capacitance change $ \Delta C/C \leq 3\%$ | | |
| | Dissipation factor change $\Delta \tan \delta \leq 0.5 \cdot 10^{-3}$ (at 1 kHz) $\leq 1.0 \cdot 10^{-3}$ (at 10 kHz) | | |
| | Insulation resistance $R_{ins} \geq 50\%$ of minimum or time constant $\tau = C_R \cdot R_{ins}$ as-delivered values | | |
| Reliability: Failure rate λ Service life t_{SL} | 1 fit ($\leq 1 \cdot 10^{-9}/h$) at $0.5 \cdot V_R$, 40 °C 200 000 h at $1.0 \cdot V_R$, $T_{op} = 85\text{ °C}$ Considered self heating for this product family is 15 °C. For conversion to other operating conditions and temperatures, refer to chapter "Quality, 2 Reliability". | | |
| Failure criteria: Total failure Failure due to variation of parameters | Short circuit or open circuit Capacitance change $ \Delta C/C > 10\%$ Dissipation factor $\tan \delta > 4 \cdot$ upper limit value Insulation resistance $R_{ins} < 1500\text{ M}\Omega$ ($C_R \leq 0.33\ \mu\text{F}$) or time constant $\tau = C_R \cdot R_{ins} < 500\text{ s}$ ($C_R > 0.33\ \mu\text{F}$) | | |



B32656S, B32658S

Snubber (wound)

Pulse handling capability

"dV/dt" represents the maximum permissible voltage change per unit of time for non-sinusoidal voltages, expressed in V/μs.

"k₀" represents the maximum permissible pulse characteristic of the waveform applied to the capacitor, expressed in V²/μs.

Note:

The values of dV/dt and k₀ provided below must not be exceeded in order to avoid damaging the capacitor.

dV/dt and k₀ values B32656S

| V _R (V DC) | V _{RMS} (V AC) | dV/dt in V/μs | k ₀ in V ² /μs |
|-----------------------|-------------------------|---------------|--------------------------------------|
| 850 | 450 | 400 | 680 000 |
| 1000 | 480 | 450 | 900 000 |
| 1250 | 500 | 500 | 1 250 000 |
| 1700 | 750 | 600 | 1 920 000 |
| 2000 | 800 | 700 | 2 800 000 |

dV/dt and k₀ values B32658S

| V _R (V DC) | V _{RMS} (V AC) | dV/dt in V/μs | k ₀ in V ² /μs |
|-----------------------|-------------------------|---------------|--------------------------------------|
| 850 | 450 | 275 | 467 500 |
| 1000 | 480 | 300 | 600 000 |
| 1250 | 500 | 350 | 875 000 |
| 1700 | 750 | 400 | 1 360 000 |
| 2000 | 800 | 475 | 1 900 000 |



Impedance Z versus frequency f
(typical values)





B32656S

Snubber (wound)

Permissible AC voltage V_{RMS} versus frequency f (for sinusoidal waveforms, $T_A \leq 90\text{ }^\circ\text{C}$)

For $T_A > 90\text{ }^\circ\text{C}$, please refer to "General technical information", section 3.2.3.

850 V DC/450 V AC

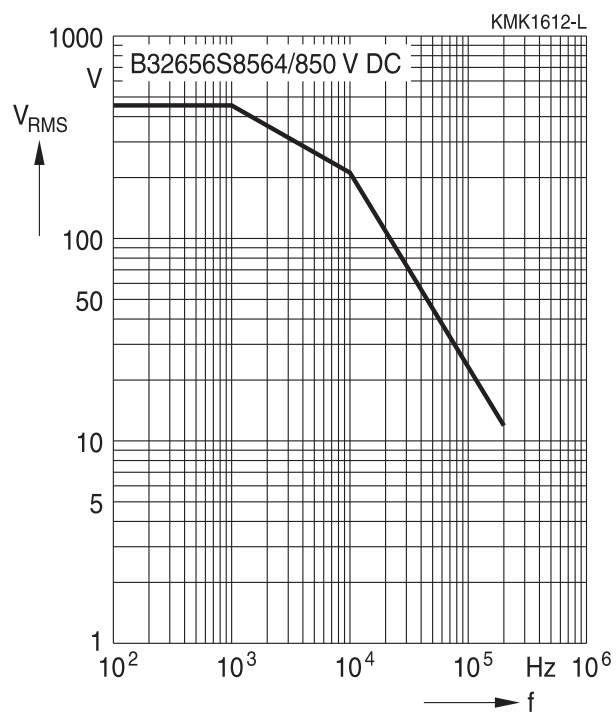

850 V DC/450 V AC

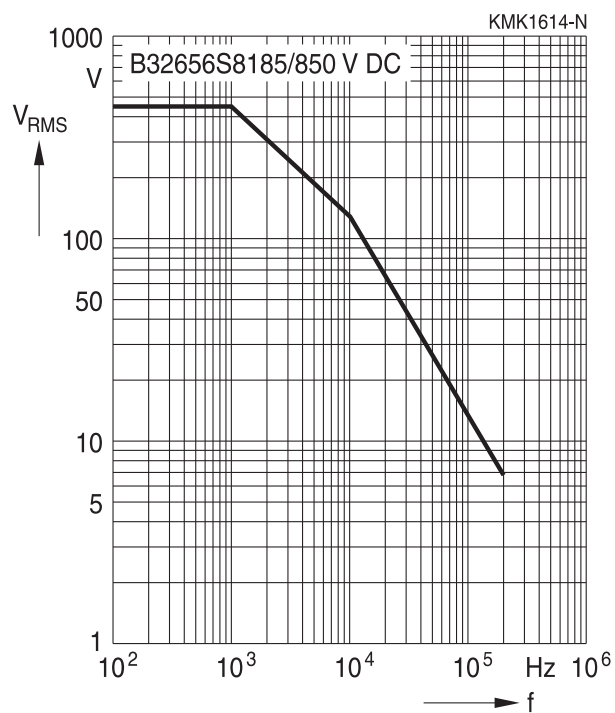

850 V DC/450 V AC

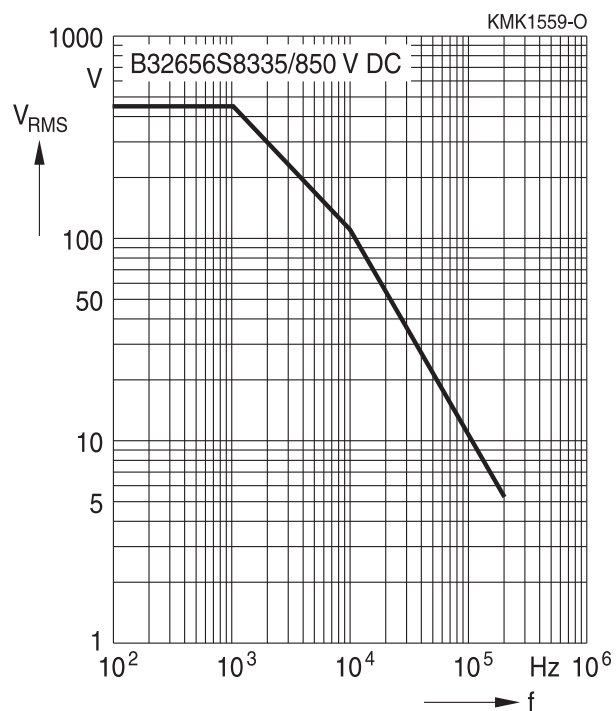

B32656S

Snubber (wound)

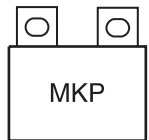

Permissible AC voltage V_{RMS} versus frequency f (for sinusoidal waveforms, $T_A \leq 90^\circ C$)

For $T_A > 90^\circ C$, please refer to "General technical information", section 3.2.3.

1000 V DC/480 V AC



1000 V DC/480 V AC



1000 V DC/480 V AC





B32656S

Snubber (wound)

Permissible AC voltage V_{RMS} versus frequency f (for sinusoidal waveforms, $T_A \leq 90^\circ\text{C}$)

For $T_A > 90^\circ\text{C}$, please refer to "General technical information", section 3.2.3.

1250 V DC/500 V AC

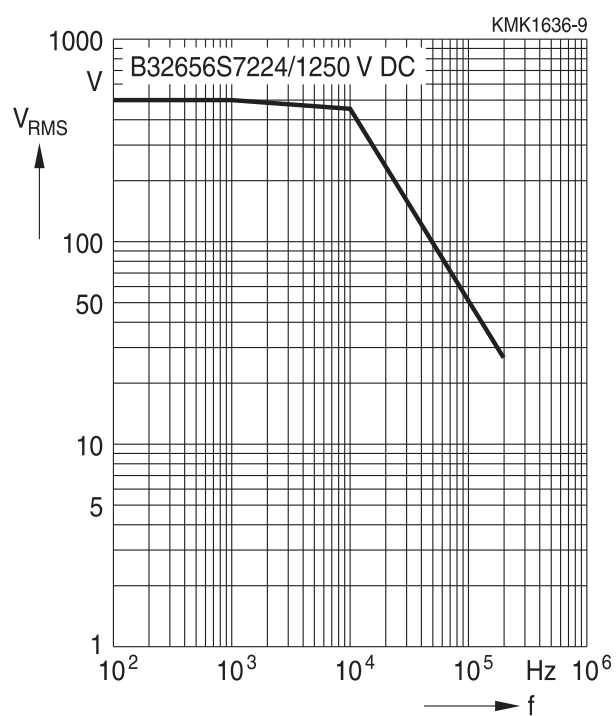

1250 V DC/500 V AC

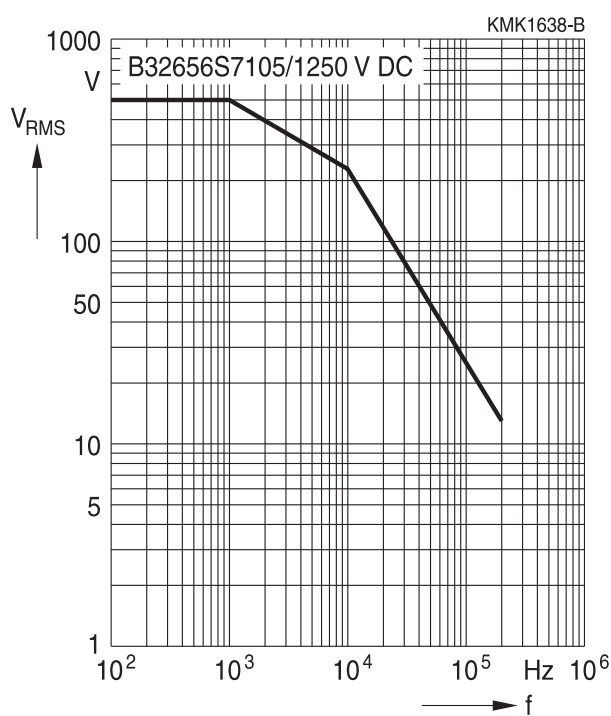

1250 V DC/500 V AC

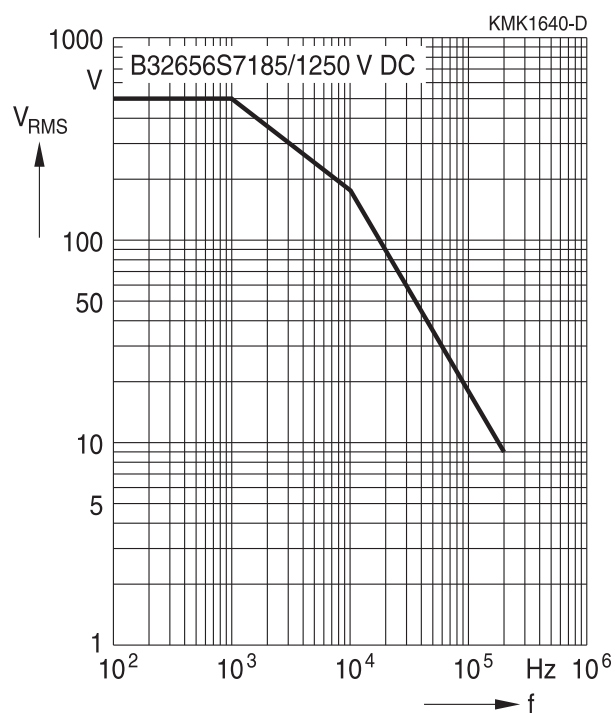



B32656S
Snubber (wound)

Permissible AC voltage V_{RMS} versus frequency f (for sinusoidal waveforms, $T_A \leq 90^\circ C$)

For $T_A > 90^\circ C$, please refer to "General technical information", section 3.2.3.

1700 V DC/750 V AC

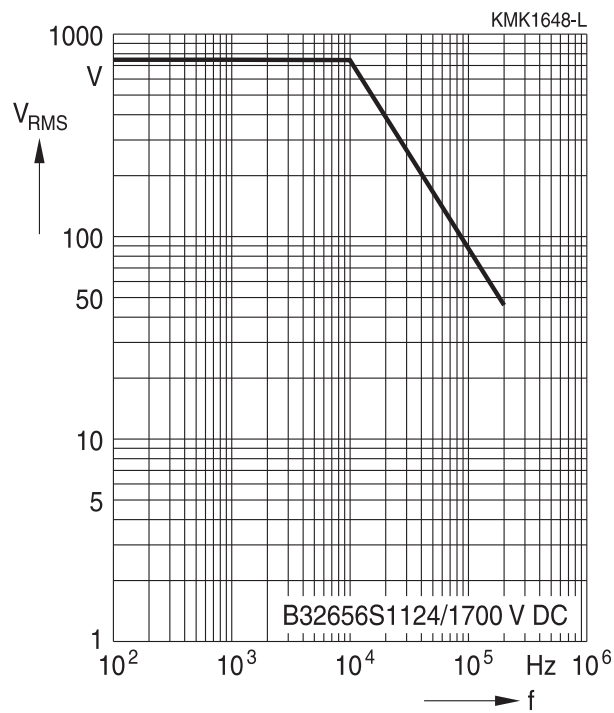

1700 V DC/750 V AC

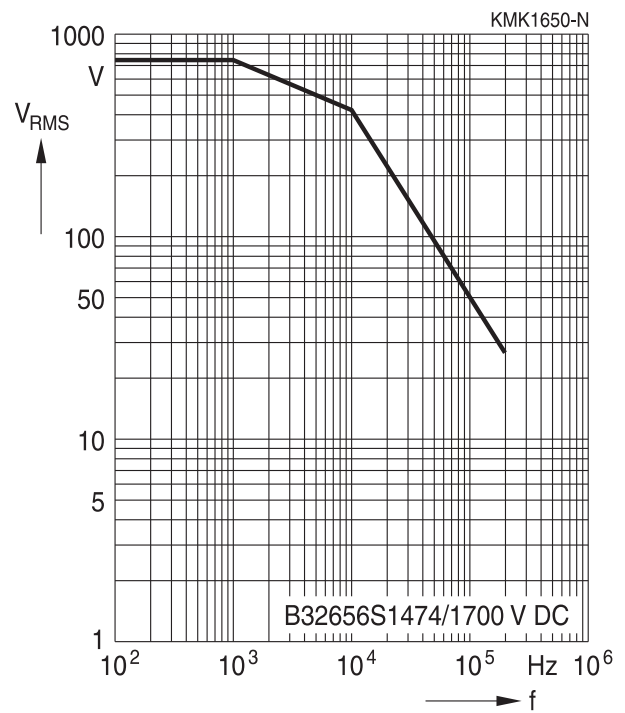

1700 V DC/750 V AC

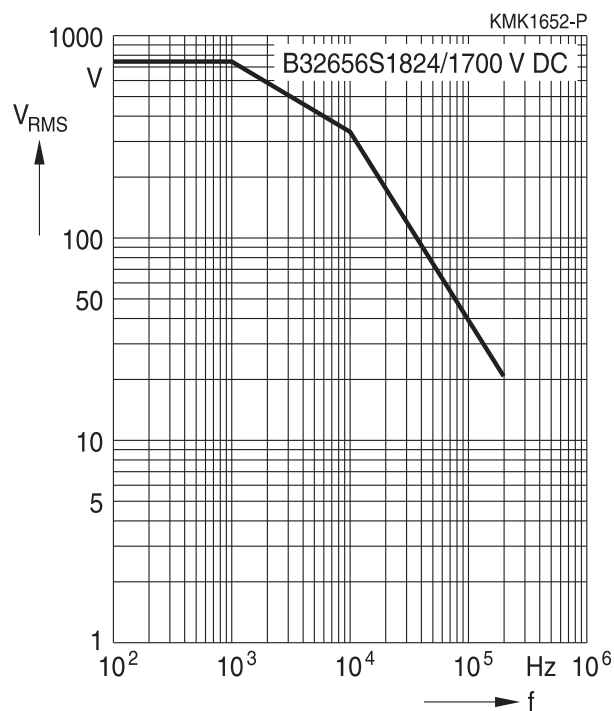

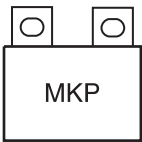

B32656S

Snubber (wound)

Permissible AC voltage V_{RMS} versus frequency f (for sinusoidal waveforms, $T_A \leq 90\text{ }^\circ\text{C}$)

For $T_A > 90\text{ }^\circ\text{C}$, please refer to "General technical information", section 3.2.3.

2000 V DC/800 V AC

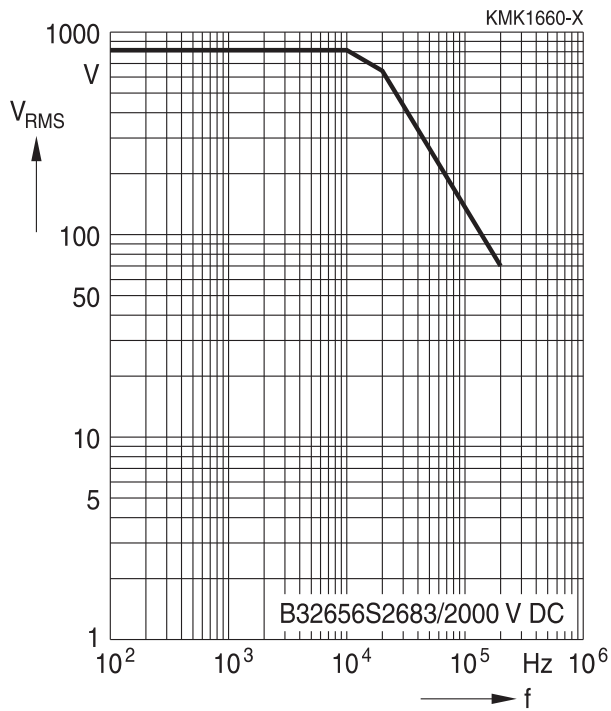

2000 V DC/800 V AC

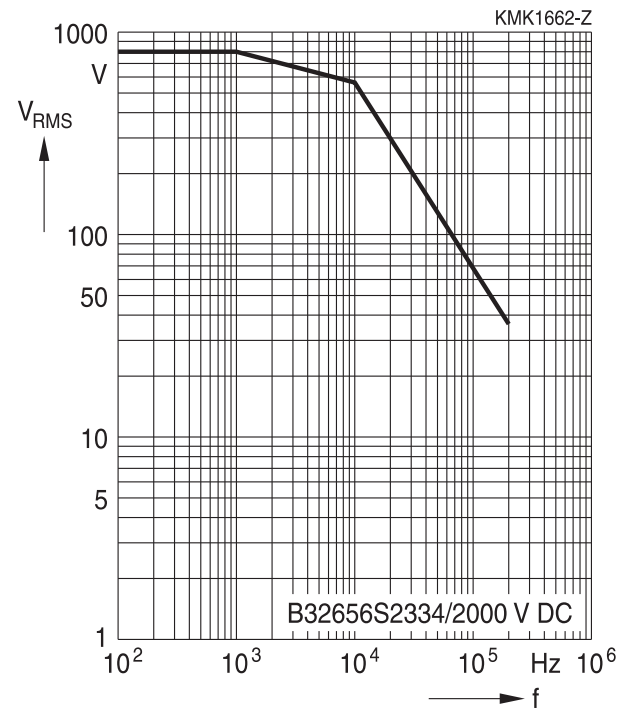

2000 V DC/800 V AC

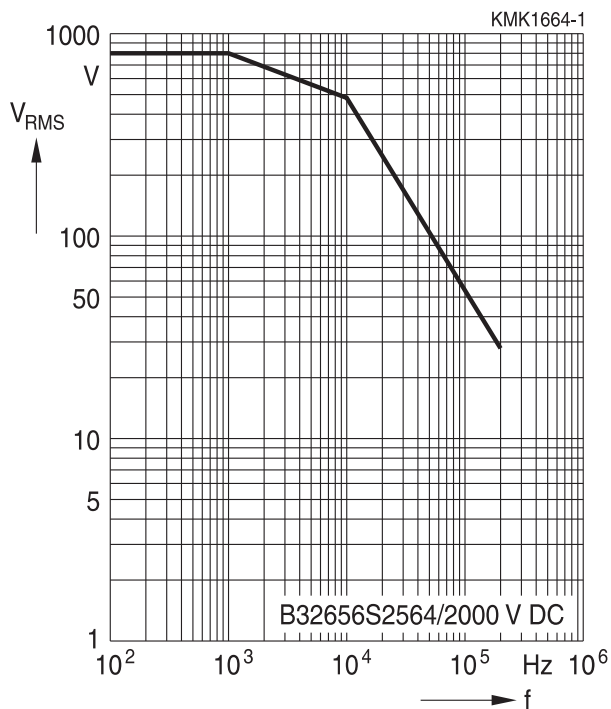



B32658S
Snubber (wound)

Permissible AC voltage V_{RMS} versus frequency f (for sinusoidal waveforms, $T_A \leq 90^\circ C$)

For $T_A > 90^\circ C$, please refer to "General technical information", section 3.2.3.

850 V DC/450 V AC

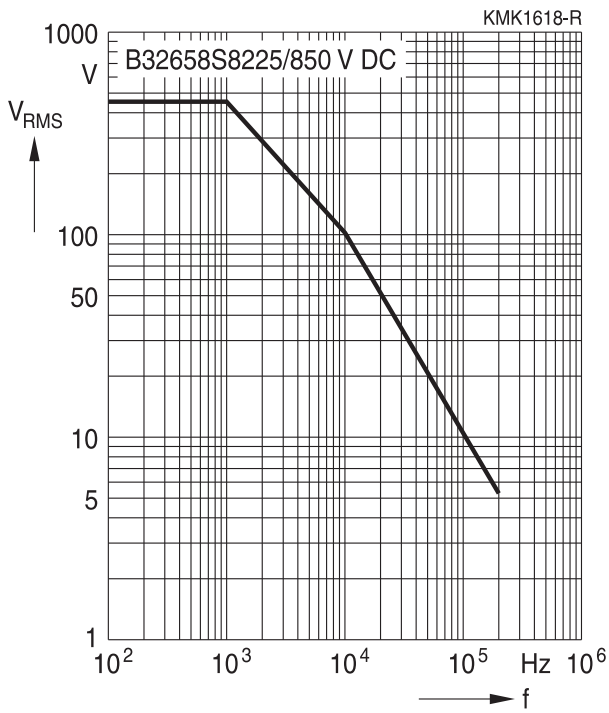

850 V DC/450 V AC

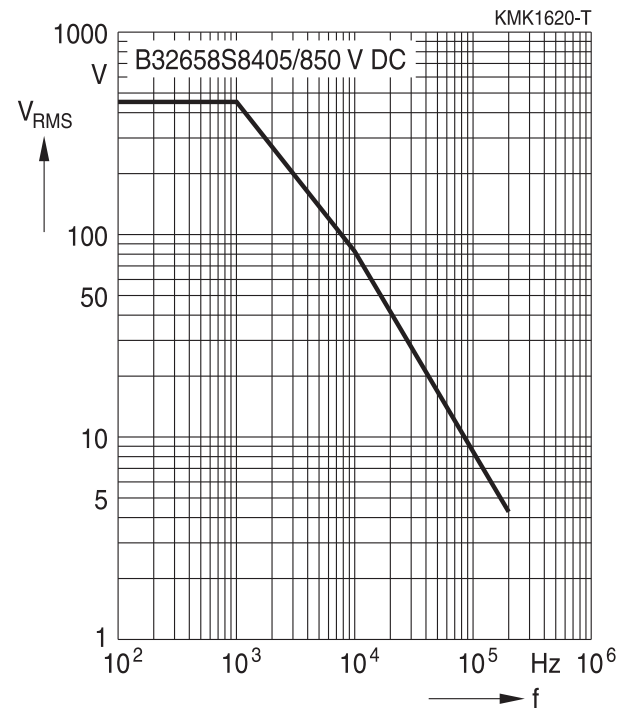

850 V DC/450 V AC

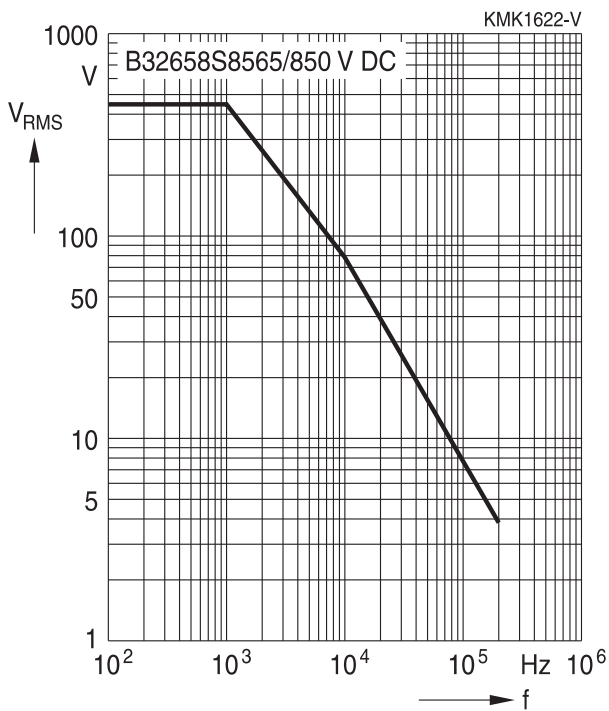



B32658S

Snubber (wound)

Permissible AC voltage V_{RMS} versus frequency f (for sinusoidal waveforms, $T_A \leq 90^\circ\text{C}$)

For $T_A > 90^\circ\text{C}$, please refer to "General technical information", section 3.2.3.

1000 V DC/480 V AC

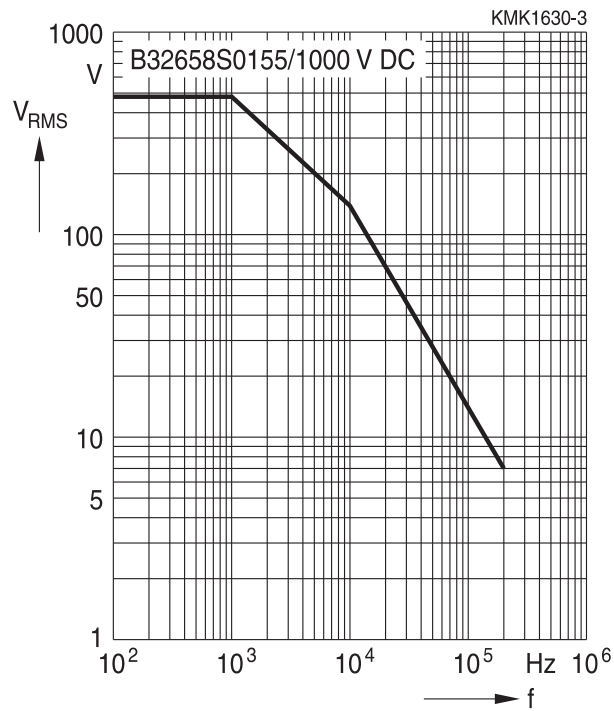

1000 V DC/480 V AC

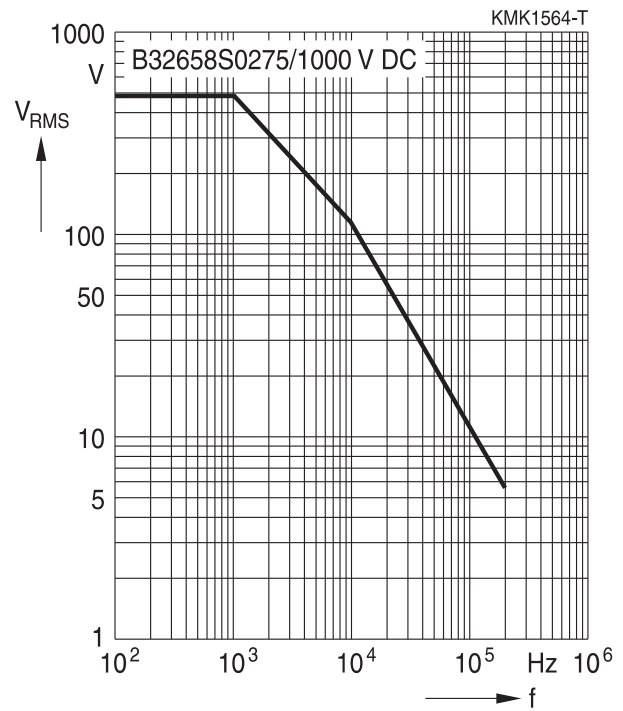

1000 V DC/480 V AC

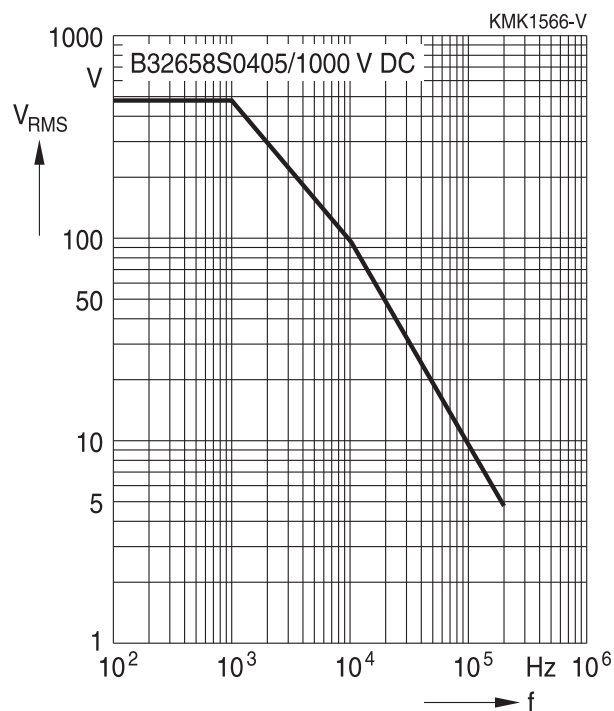



B32658S
Snubber (wound)

Permissible AC voltage V_{RMS} versus frequency f (for sinusoidal waveforms, $T_A \leq 90^\circ C$)

For $T_A > 90^\circ C$, please refer to "General technical information", section 3.2.3.

1250 V DC/500 V AC

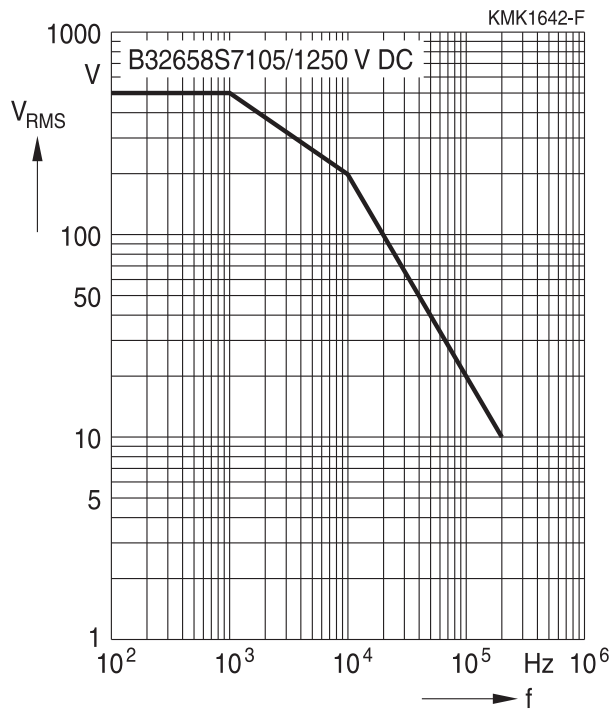

1250 V DC/500 V AC

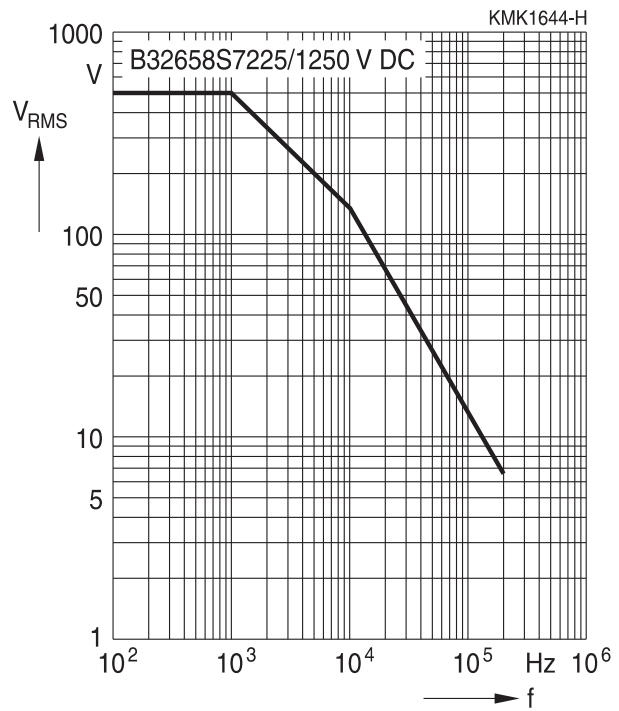

1250 V DC/500 V AC

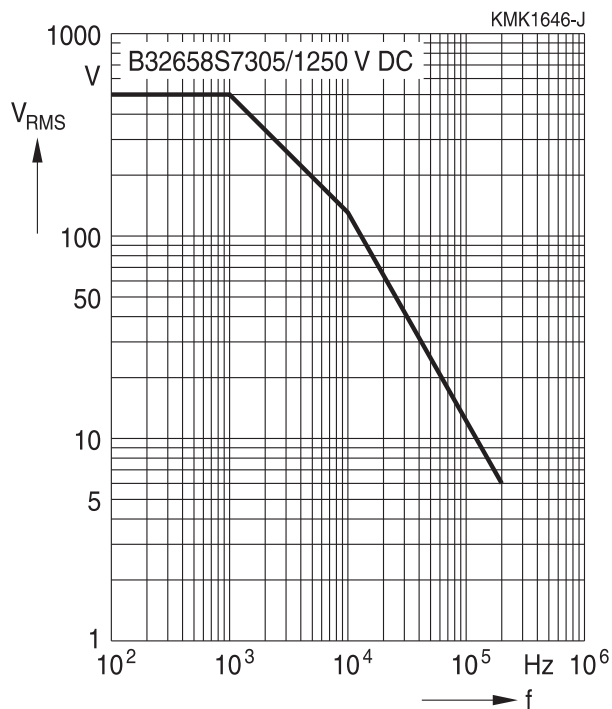



B32658S

Snubber (wound)

Permissible AC voltage V_{RMS} versus frequency f (for sinusoidal waveforms, $T_A \leq 90\text{ }^\circ\text{C}$)

For $T_A > 90\text{ }^\circ\text{C}$, please refer to "General technical information", section 3.2.3.

1700 V DC/500 V AC

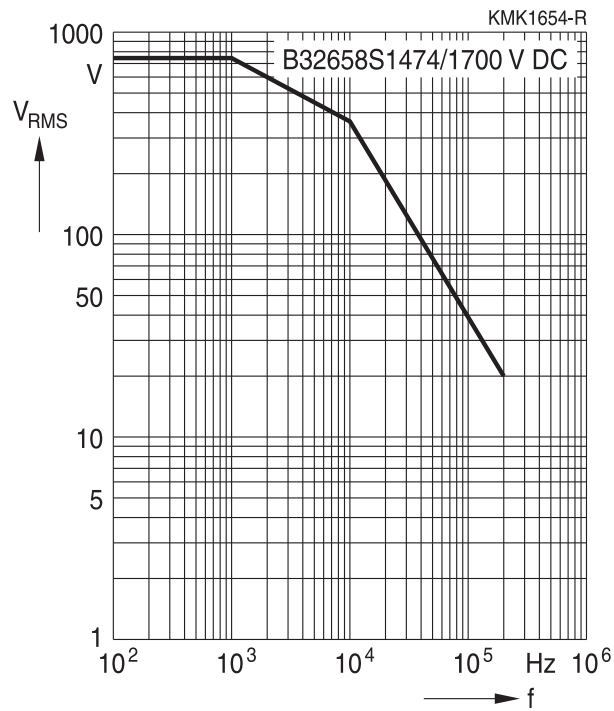

1700 V DC/500 V AC

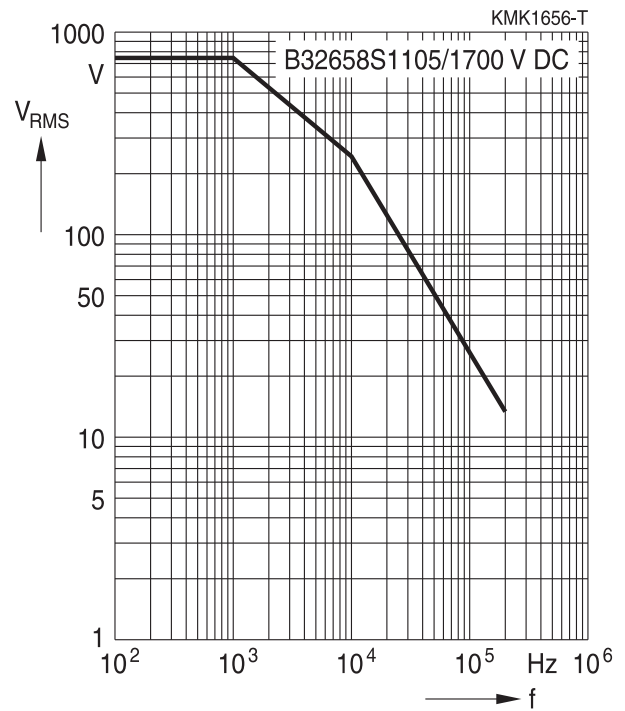

1700 V DC/500 V AC

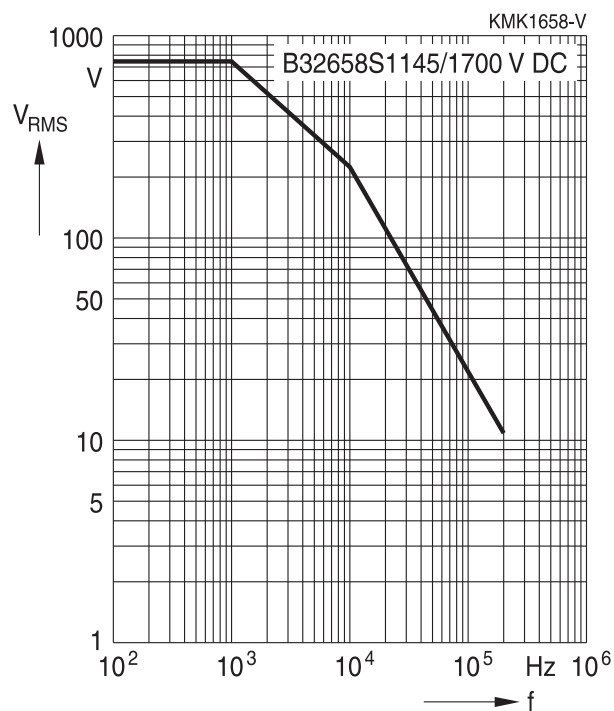



B32658S
Snubber (wound)

Permissible AC voltage V_{RMS} versus frequency f (for sinusoidal waveforms, $T_A \leq 90^\circ C$)

For $T_A > 90^\circ C$, please refer to "General technical information", section 3.2.3.

2000 V DC/800 V AC

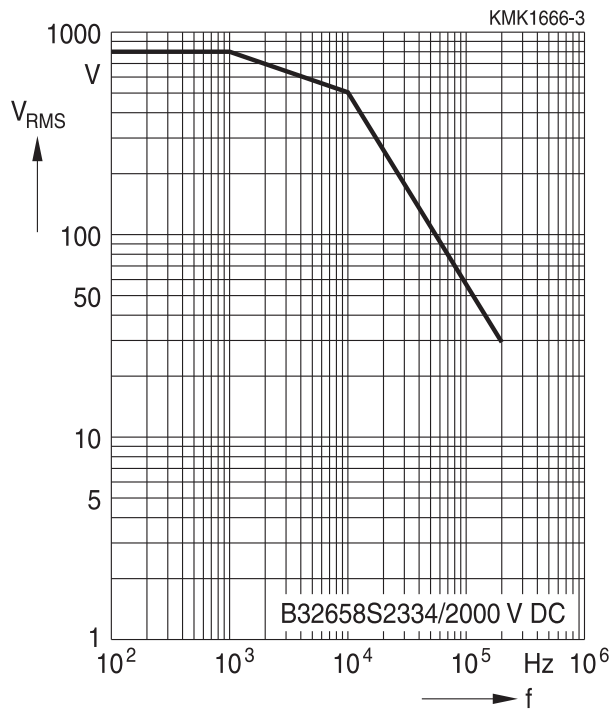

2000 V DC/800 V AC

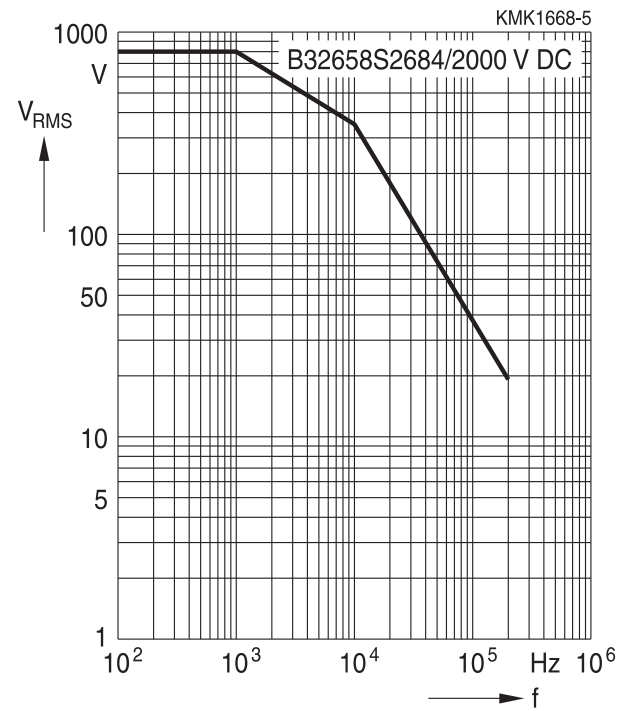

2000 V DC/800 V AC

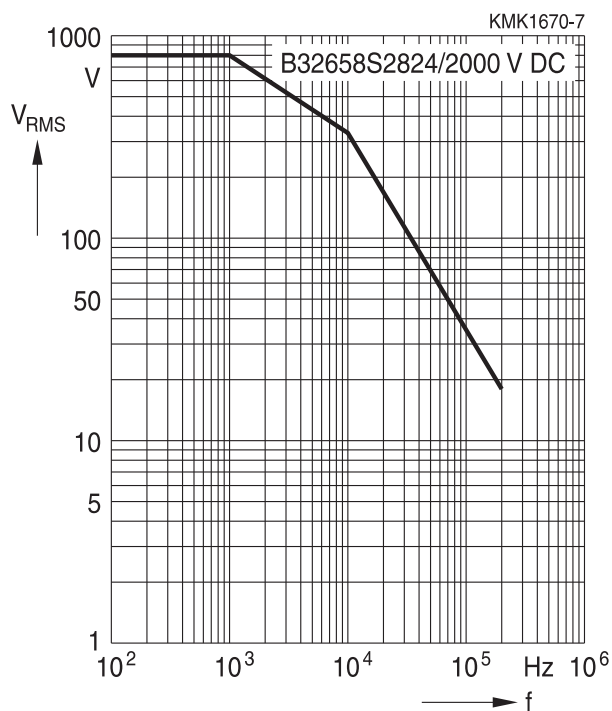

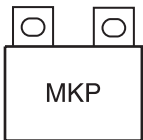

B32656S

Snubber (wound)

Permissible current I_{RMS} versus frequency f (for sinusoidal waveforms $T_A \leq 90\text{ °C}$)

For $T_A > 90\text{ °C}$, please use derating factor F_T .

850 V DC/450 V AC

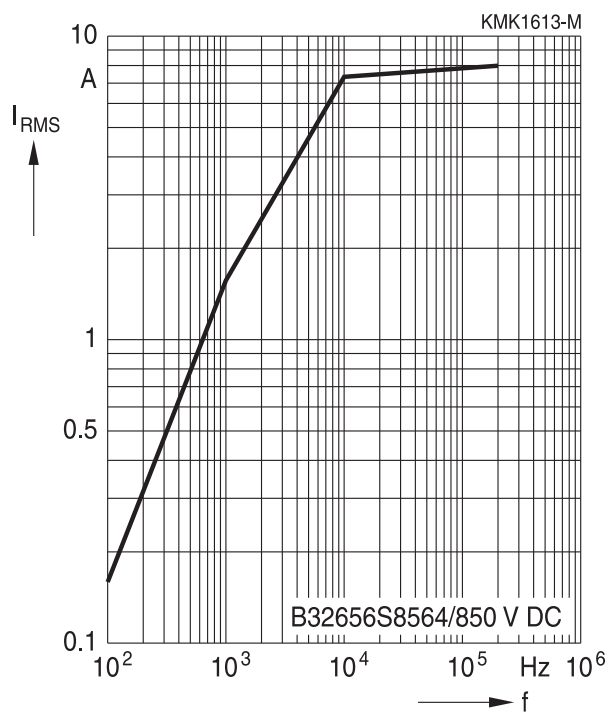

850 V DC/450 V AC

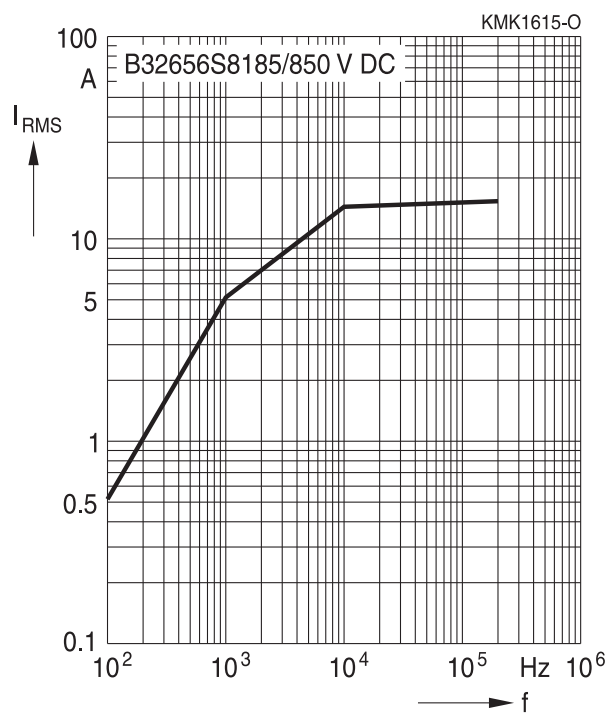

850 V DC/450 V AC

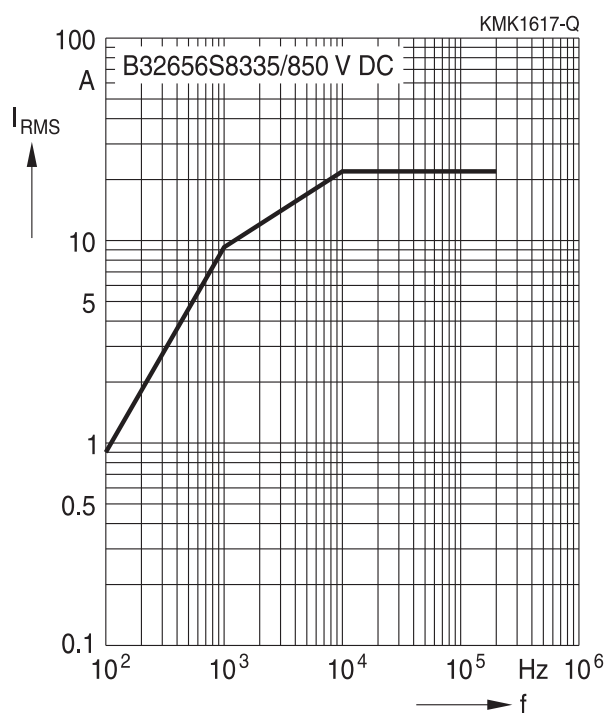



B32656S
Snubber (wound)

Permissible current I_{RMS} versus frequency f (for sinusoidal waveforms $T_A \leq 90^\circ\text{C}$)

For $T_A > 90^\circ\text{C}$, please use derating factor F_T .

1000 V DC/480 V AC

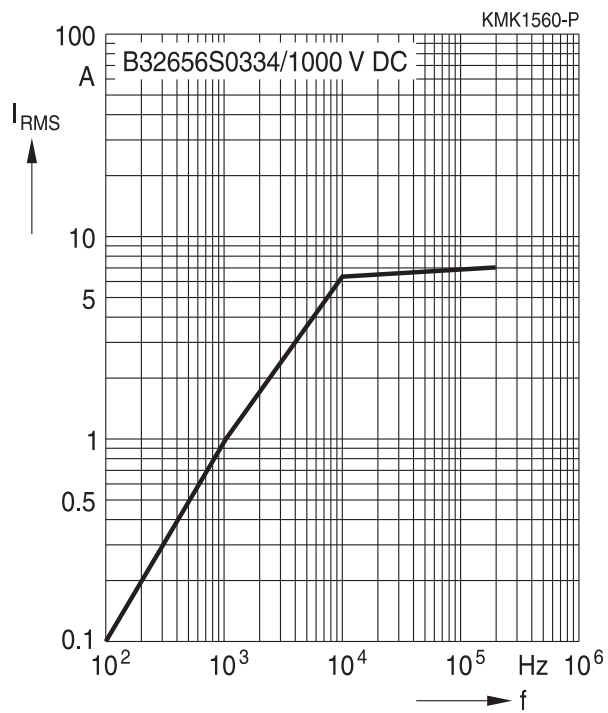

1000 V DC/480 V AC

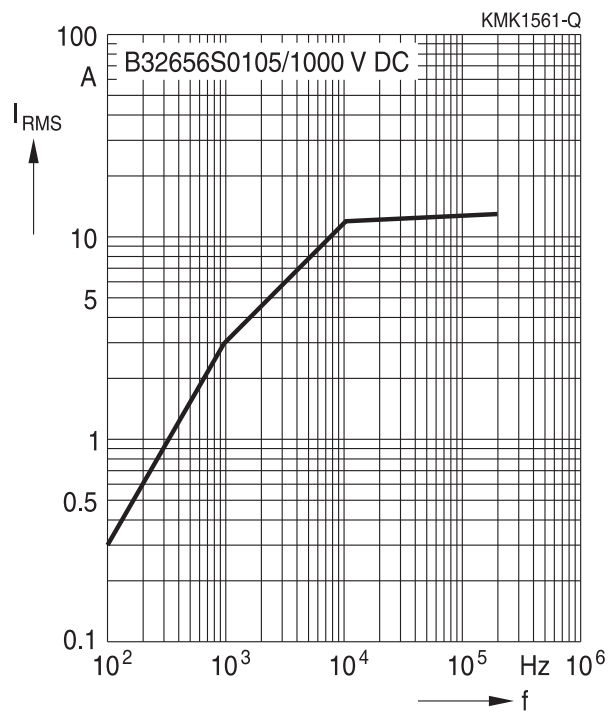

1000 V DC/480 V AC

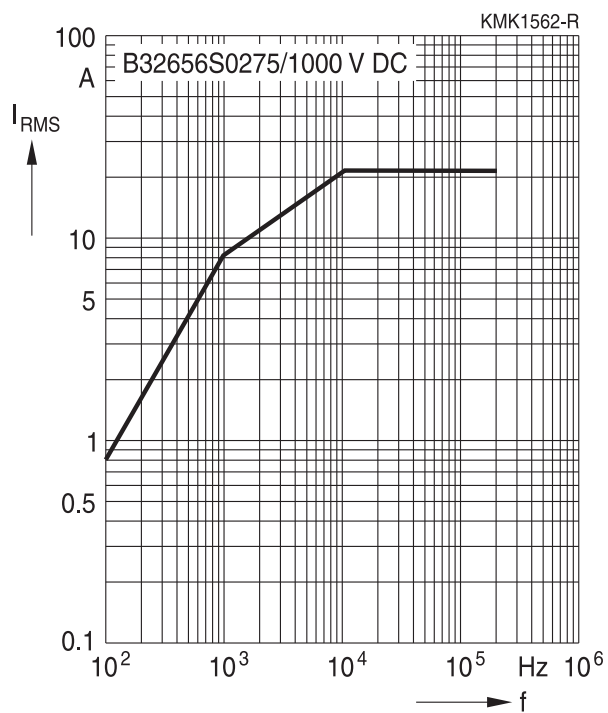



B32656S

Snubber (wound)

Permissible current I_{RMS} versus frequency f (for sinusoidal waveforms $T_A \leq 90\text{ }^\circ\text{C}$)

For $T_A > 90\text{ }^\circ\text{C}$, please use derating factor F_T .

1250 V DC/500 V AC

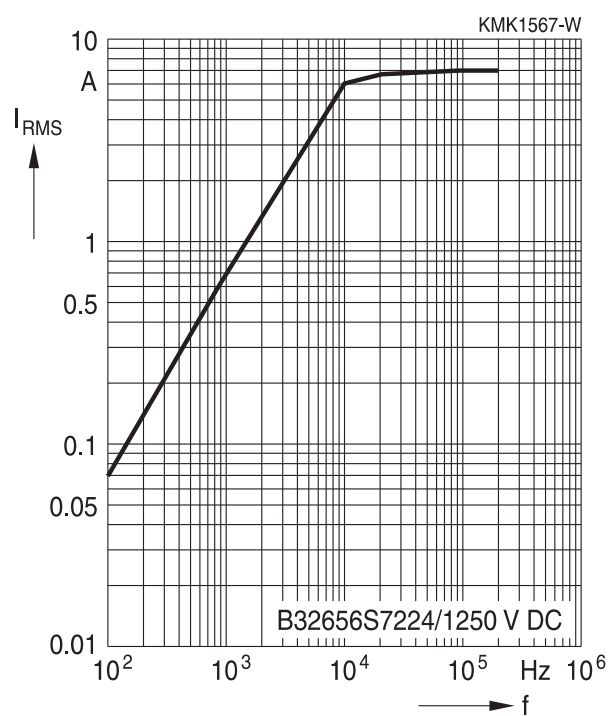

1250 V DC/500 V AC



1250 V DC/500 V AC

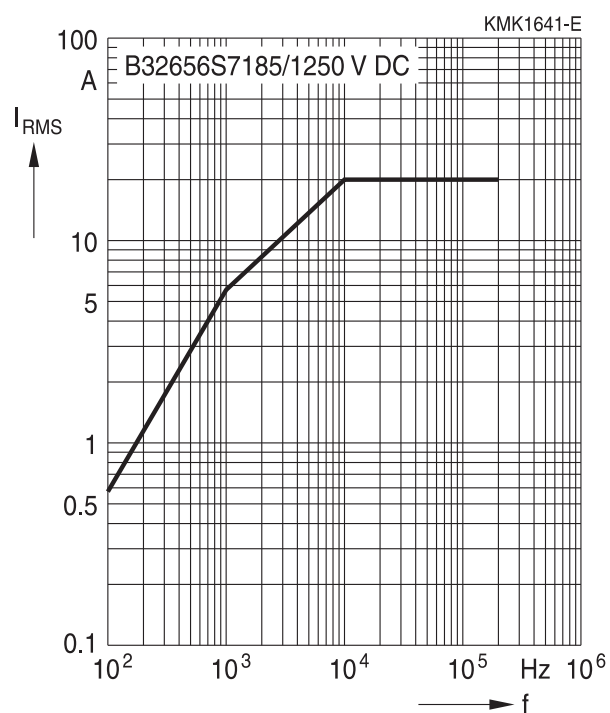



B32656S
Snubber (wound)

Permissible current I_{RMS} versus frequency f (for sinusoidal waveforms $T_A \leq 90^\circ\text{C}$)

For $T_A > 90^\circ\text{C}$, please use derating factor F_T .

1700 V DC/750 V AC

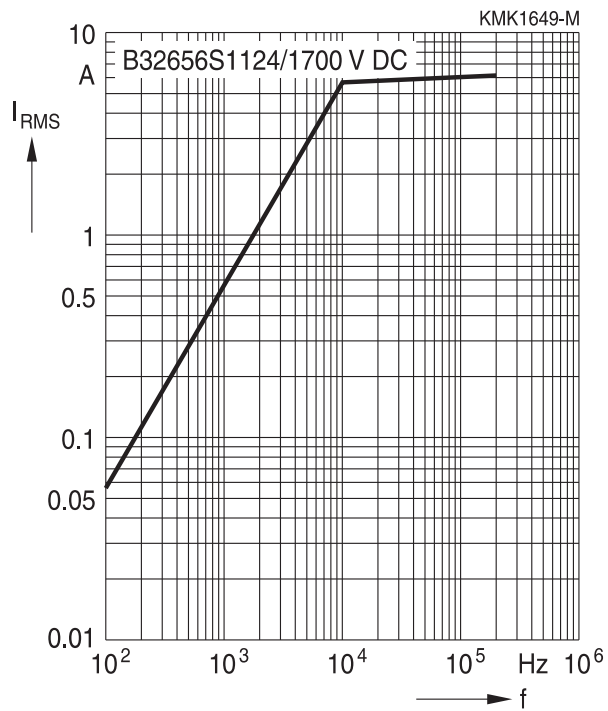

1700 V DC/750 V AC

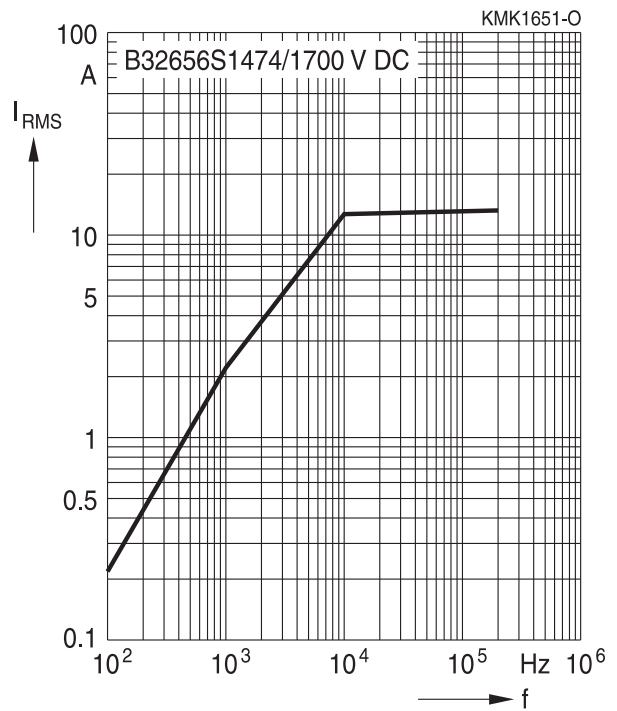

1700 V DC/750 V AC

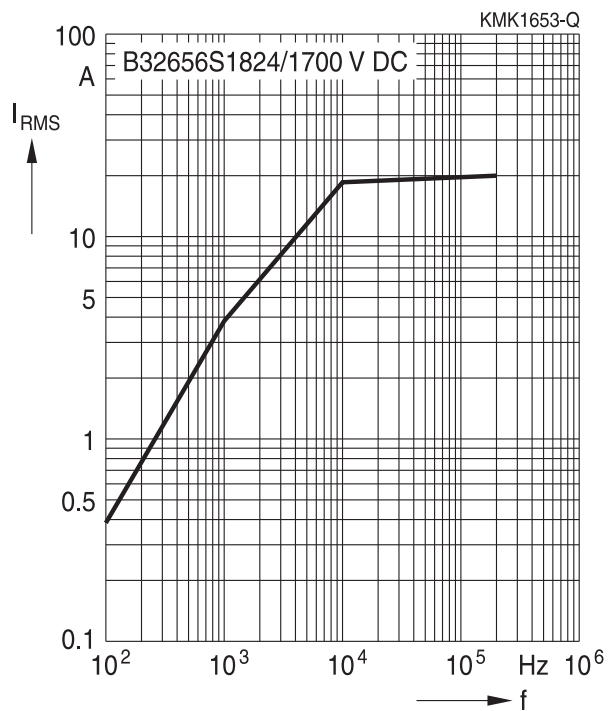

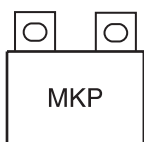

B32656S

Snubber (wound)

Permissible current I_{RMS} versus frequency f (for sinusoidal waveforms $T_A \leq 90\text{ }^\circ\text{C}$)

For $T_A > 90\text{ }^\circ\text{C}$, please use derating factor F_T .

2000 V DC/800 V AC

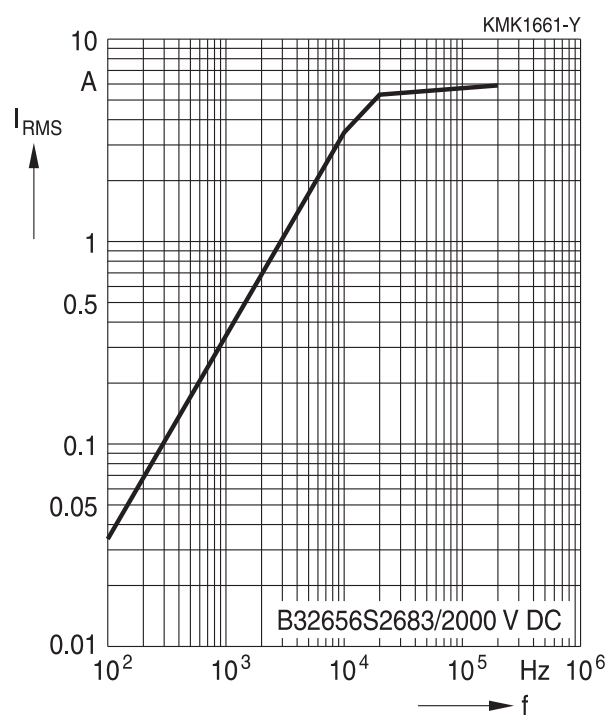

2000 V DC/800 V AC

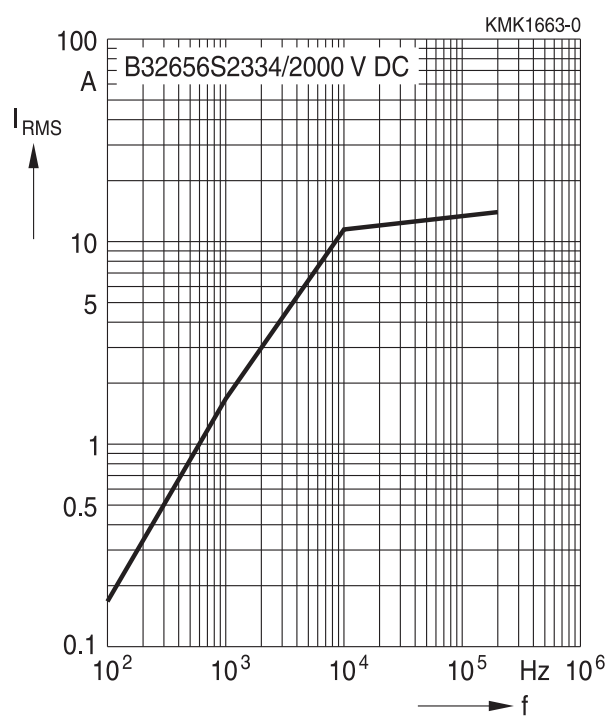

2000 V DC/800 V AC

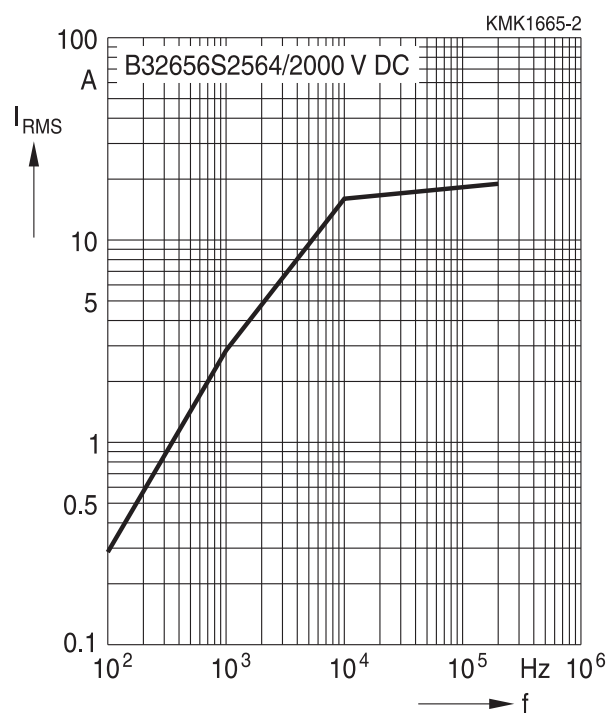



B32658S
Snubber (wound)

Permissible current I_{RMS} versus frequency f (for sinusoidal waveforms $T_A \leq 90^\circ C$)

For $T_A > 90^\circ C$, please use derating factor F_T .

850 V DC/450 V AC



850 V DC/450 V AC



850 V DC/450 V AC





B32658S

Snubber (wound)

Permissible current I_{RMS} versus frequency f (for sinusoidal waveforms $T_A \leq 90\text{ }^\circ\text{C}$)

For $T_A > 90\text{ }^\circ\text{C}$, please use derating factor F_T .

1000 V DC/480 V AC

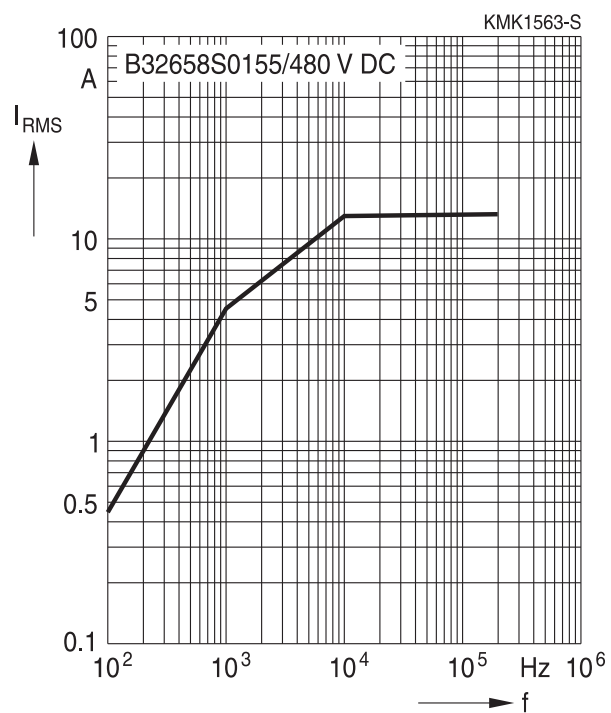

1000 V DC/480 V AC

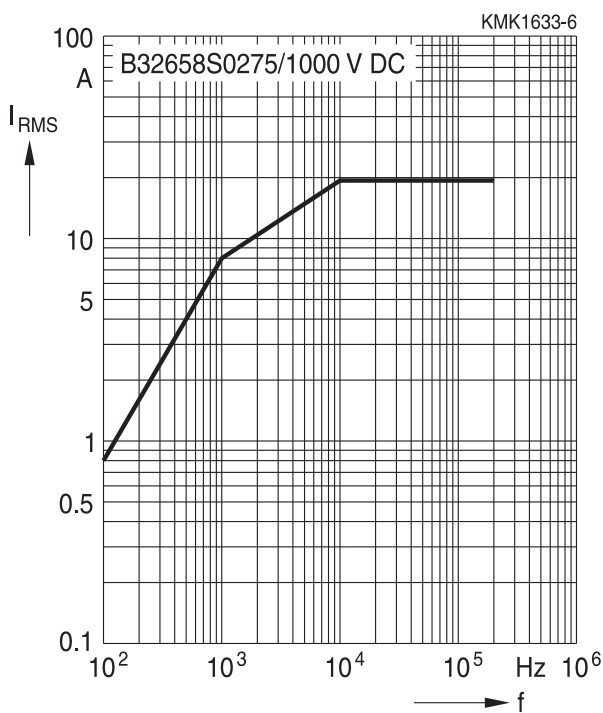

1000 V DC/480 V AC

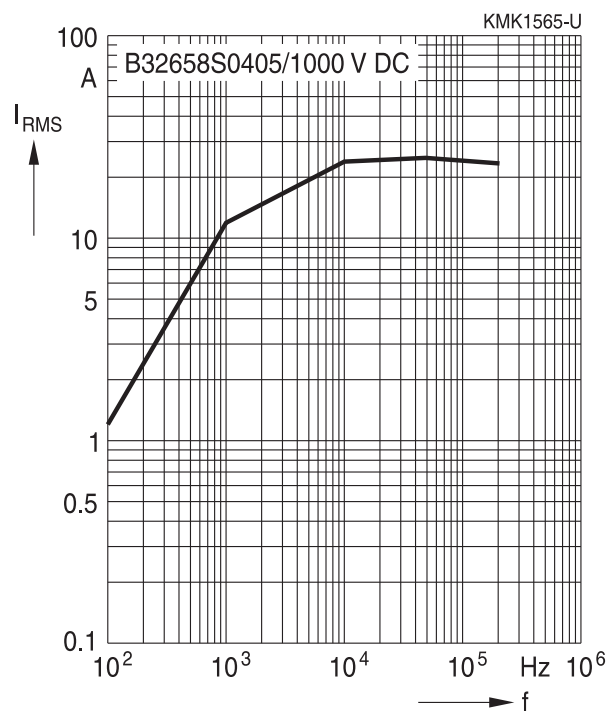



B32658S
Snubber (wound)

Permissible current I_{RMS} versus frequency f (for sinusoidal waveforms $T_A \leq 90^\circ\text{C}$)

For $T_A > 90^\circ\text{C}$, please use derating factor F_T .

1250 V DC/500 V AC



1250 V DC/500 V AC

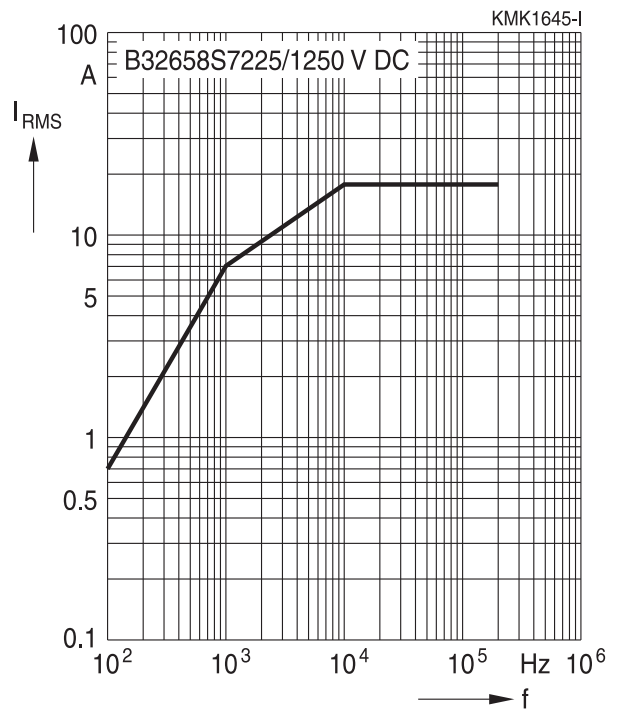

1250 V DC/500 V AC

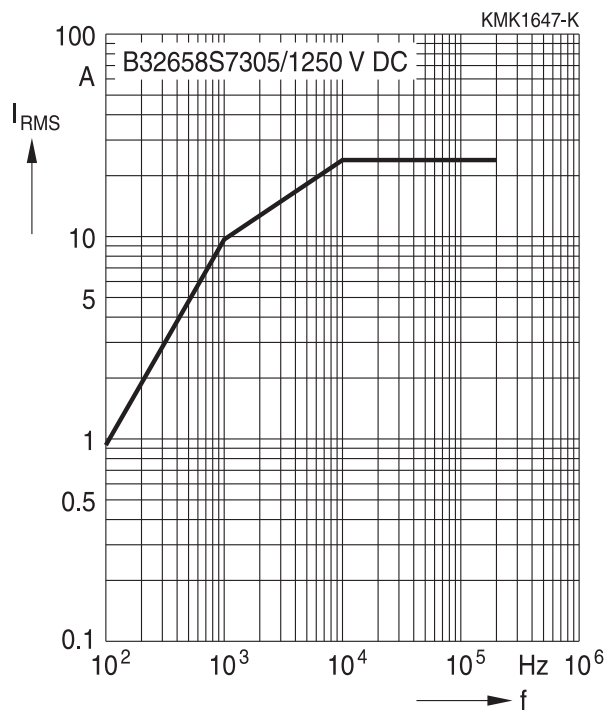



B32658S

Snubber (wound)

Permissible current I_{RMS} versus frequency f (for sinusoidal waveforms $T_A \leq 90\text{ }^\circ\text{C}$)

For $T_A > 90\text{ }^\circ\text{C}$, please use derating factor F_T .

1700 V DC/500 V AC



1700 V DC/500 V AC

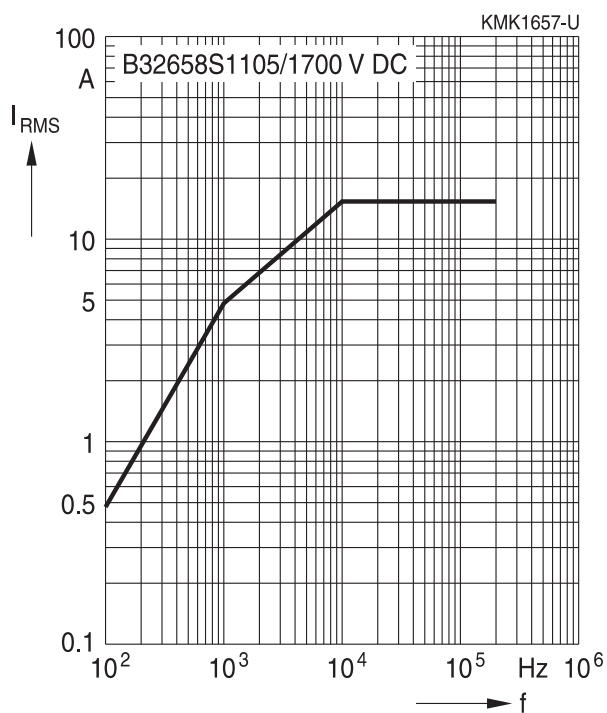

1700 V DC/500 V AC

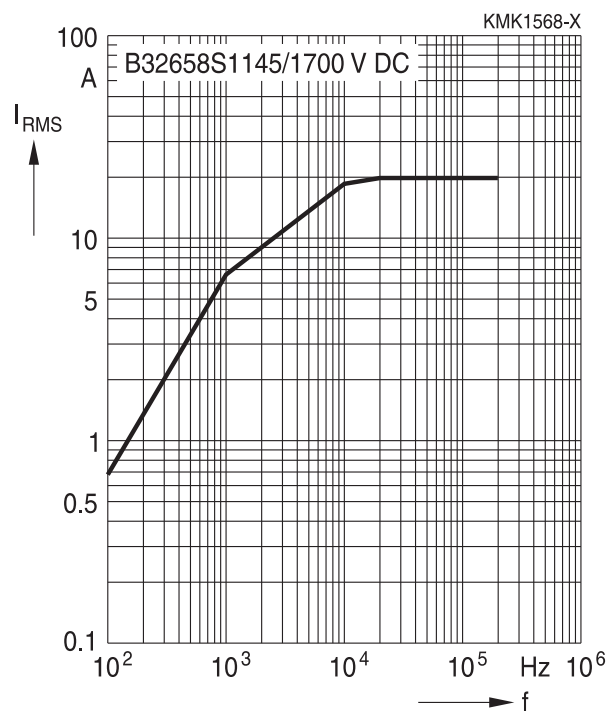

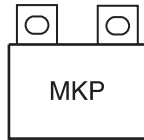

B32658S
Snubber (wound)

Permissible current I_{RMS} versus frequency f (for sinusoidal waveforms $T_A \leq 90^\circ C$)

For $T_A > 90^\circ C$, please use derating factor F_T .

2000 V DC/800 V AC

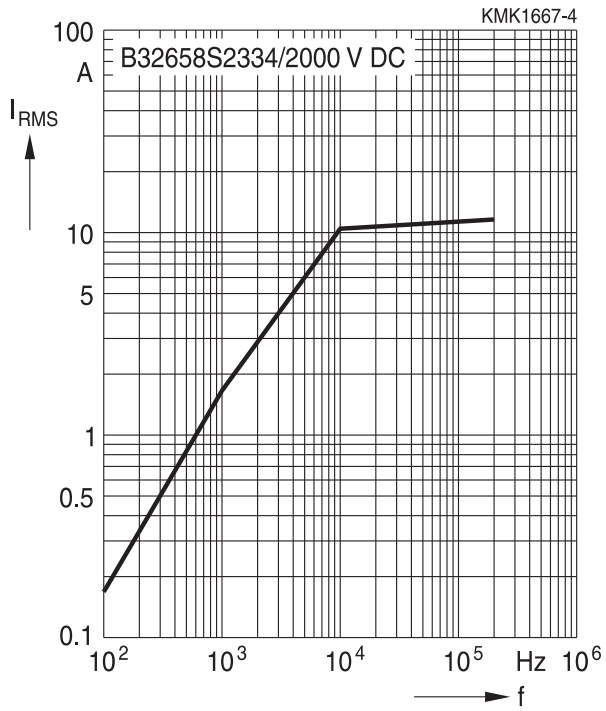

2000 V DC/800 V AC

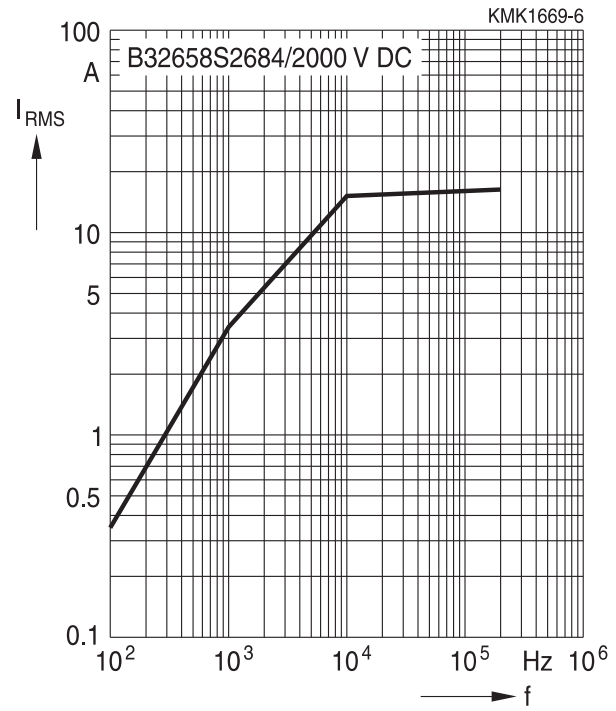

2000 V DC/800 V AC

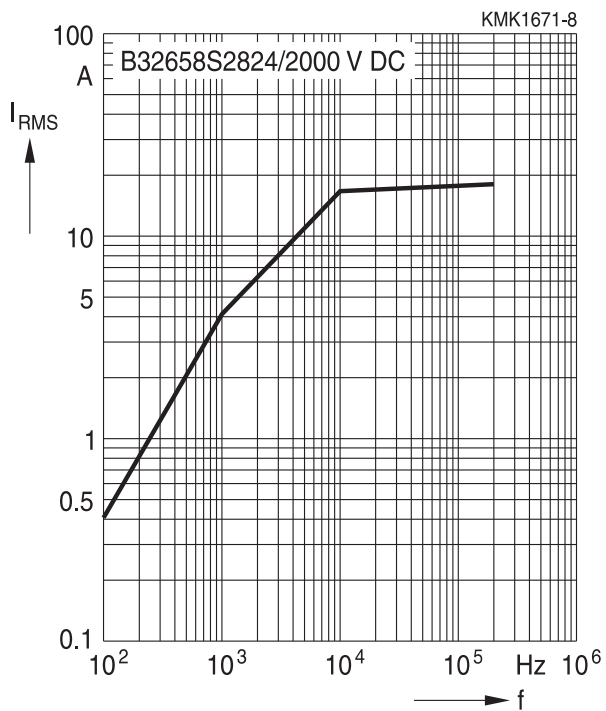



B32656S, B32658S

Snubber (wound)

Maximum AC voltage (V_{RMS}), current (I_{RMS}) versus frequency and temperature for $T_A > 90\text{ }^\circ\text{C}$

The graphs described in the previous section for the permissible AC voltage (V_{RMS}) or current (I_{RMS}) versus frequency are given for a maximum ambient temperature $T_A \leq 90\text{ }^\circ\text{C}$. In case of higher ambient temperatures (T_A), the self-heating (ΔT) of the component must be reduced to avoid that temperature of the component ($T_{op} = T_A + \Delta T$) reaches values above maximum operating temperature. The factor F_T shall be applied in the following way:

$$I_{RMS}(T_A) = I_{RMS, T_A \leq 90\text{ }^\circ\text{C}} \cdot F_T(T_A)$$

$$V_{RMS}(T_A) = V_{RMS, T_A \leq 90\text{ }^\circ\text{C}} \cdot F_T(T_A)$$

And F_T is given by the following curve:

Curves characteristics (I_{RMS} derating versus temperature)

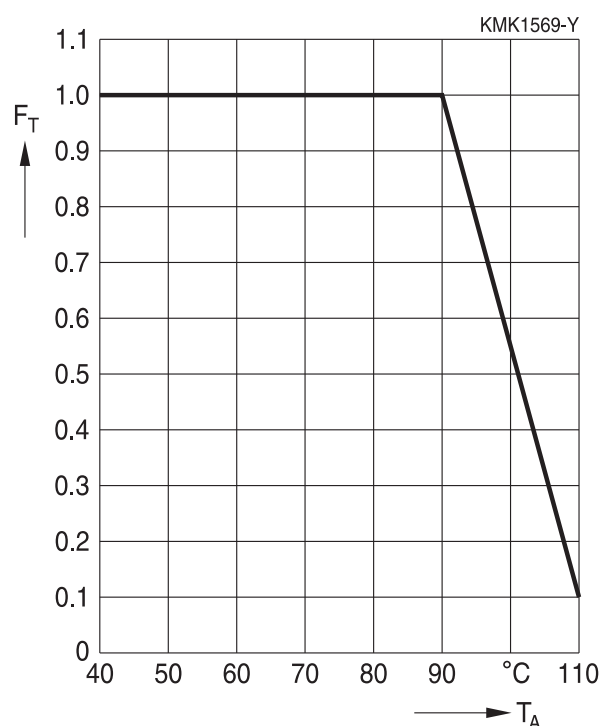

Maximum I_{RMS} current as function of the ambient temperature: $I_{RMS}(T_A) = \text{Factor} \times I_{RMS}(90\text{ }^\circ\text{C})$

Testing and Standards

| Test | Reference | Conditions of test | Performance requirements |
|-----------------------------|---------------------|--|---|
| Electrical parameters | IEC 60384-16:2005 | Voltage proof, 1.6 V _R , 1 minute Insulation resistance, R _{ins} Capacitance, C Dissipation factor, tan δ | Within specified limits |
| Robustness of terminations | IEC 60068-2-21:2006 | Only tests Ua1 (20N) and Ud | Capacitance and tan δ within specified limits |
| Rapid change of temperature | IEC 60384-16:2005 | T _A = lower category temperature T _B = upper category temperature Five cycles, duration t = 30 min | ΔC/C ₀ ≤ 2% Δ tan δ ≤ 0.002 R _{ins} ≥ 50% of initial limit |
| Vibration | IEC 60384-16:2005 | Test F _C : vibration sinusoidal Displacement: 0.75 mm Acceleration: 98 m/s ² Frequency: 10 Hz ... 500 Hz Test duration: 3 orthogonal axes, 2 hours each axe | No visible damage |
| Bump | IEC 60384-16:2005 | Test Eb: Total 4000 bumps with 390 m/s ² mounted on PCB Duration: 6 ms | No visible damage ΔC/C ₀ ≤ 2% Δ tan δ ≤ 0.002 R _{ins} ≥ 50% of initial limit |
| Climatic sequence | IEC 60384-16:2005 | Dry heat Tb[T _B] / 16 h Damp heat cyclic, 1 st cycle +55 °C / 24 h / 95% ... 100% RH Cold Ta[T _A] / 2 h Damp heat cyclic, 5 cycles +55 °C / 24 h / 95% ... 100% RH | No visible damage ΔC/C ₀ ≤ 3% Δ tan δ ≤ 0.003 R _{ins} ≥ 50% of initial limit |
| Damp heat, steady state | IEC 60384-16:2005 | Test Ca 40 °C / 93% RH / 56 days | No visible damage ΔC/C ₀ ≤ 3% Δ tan δ ≤ 0.002 R _{ins} ≥ 50% of initial limit |
| Advanced biased humidity | | 60 °C / 95% RH / 1000 hours with V _R DC | No visible damage ΔC/C ₀ ≤ 10% Δ tan δ ≤ 0.002 R _{ins} ≥ 50% of initial limit |



B32656S, B32658S

Snubber (wound)

| Test | Reference | Conditions of test | Performance requirements |
|-------------|-----------|---|--|
| Endurance A | | 85 °C / 1.25 V _R / 2000 hours | No visible damage ΔC/C ₀ ≤ 3% Δ tan δ ≤ 0.002 R _{ins} ≥ 50% of initial limit |
| Endurance B | | 110 °C / 1.25 V _C / 2000 hours | No visible damage ΔC/C ₀ ≤ 3% Δ tan δ ≤ 0.002 R _{ins} ≥ 50% of initial limit |

Mounting guidelines

1 Soldering

1.1 Solderability of leads

The solderability of terminal leads is tested to IEC 60068-2-20, test Ta, method 1.

Before a solderability test is carried out, terminals are subjected to accelerated ageing (to IEC 60068-2-2, test Ba: 4 h exposure to dry heat at 155 °C). Since the ageing temperature is far higher than the upper category temperature of the capacitors, the terminal wires should be cut off from the capacitor before the ageing procedure to prevent the solderability being impaired by the products of any capacitor decomposition that might occur.

| | |
|-------------------------|---|
| Solder bath temperature | 235 ±5 °C |
| Soldering time | 2.0 ±0.5 s |
| Immersion depth | 2.0 +0/−0.5 mm from capacitor body or seating plane |
| Evaluation criteria: | |
| Visual inspection | Wetting of wire surface by new solder ≥90%, free-flowing solder |



1.2 Resistance to soldering heat

Resistance to soldering heat is tested to IEC 60068-2-20, test Tb, method 1.

Conditions:

| Series | Solder bath temperature | Soldering time |
|---|-------------------------|---|
| MKT boxed (except 2.5 × 6.5 × 7.2 mm) coated uncoated (lead spacing >10 mm) | 260 ±5 °C | 10 ±1 s |
| MFP | | |
| MKP (lead spacing >7.5 mm) | | |
| MKT boxed (case 2.5 × 6.5 × 7.2 mm) | 260 ±5 °C | 5 ±1 s |
| MKP (lead spacing ≤7.5 mm) | | <4 s |
| MKT uncoated (lead spacing ≤10 mm) | | recommended soldering profile for MKT uncoated (lead spacing ≤ 10 mm) and insulated (B32559) |
| MKT insulated (B32559) | | |



| | |
|----------------------|---|
| Immersion depth | 2.0 +0/−0.5 mm from capacitor body or seating plane |
| Shield | Heat-absorbing board, (1.5 ±0.5) mm thick, between capacitor body and liquid solder |
| Evaluation criteria: | |
| Visual inspection | No visible damage |
| $\Delta C/C_0$ | 2% for MKT/MKP/MFP 5% for EMI suppression capacitors |
| $\tan \delta$ | As specified in sectional specification |

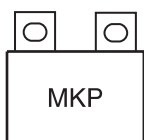

B32656S, B32658S

Snubber (wound)

1.3 General notes on soldering

Permissible heat exposure loads on film capacitors are primarily characterized by the upper category temperature T_{max} . Long exposure to temperatures above this type-related temperature limit can lead to changes in the plastic dielectric and thus change irreversibly a capacitor's electrical characteristics. For short exposures (as in practical soldering processes) the heat load (and thus the possible effects on a capacitor) will also depend on other factors like:

- Pre-heating temperature and time
- Forced cooling immediately after soldering
- Terminal characteristics:
diameter, length, thermal resistance, special configurations (e.g. crimping)
- Height of capacitor above solder bath
- Shadowing by neighboring components
- Additional heating due to heat dissipation by neighboring components
- Use of solder-resist coatings

The overheating associated with some of these factors can usually be reduced by suitable countermeasures. For example, if a pre-heating step cannot be avoided, an additional or reinforced cooling process may possibly have to be included.

EPCOS recommendations

As a reference, the recommended wave soldering profile for our film capacitors is as follows:



T_s : Capacitor body maximum temperature at wave soldering

T_p : Capacitor body maximum temperature at pre-heating

KMK1745-A-E

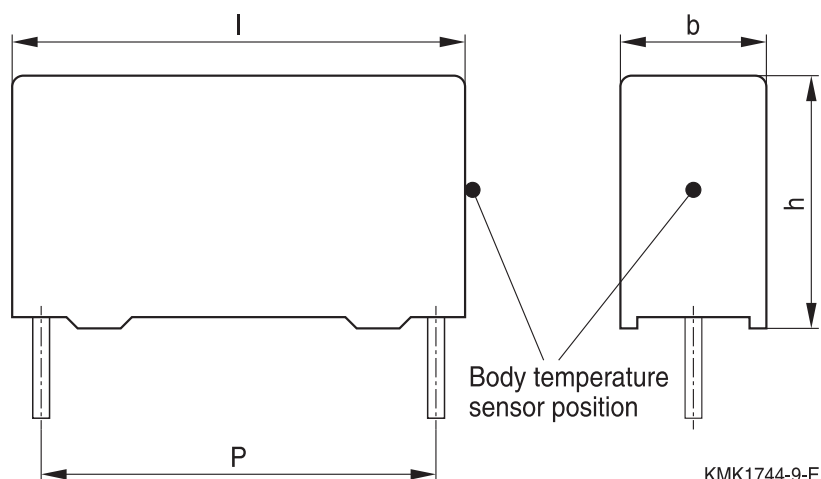

Body temperature should follow the description below:

- MKP capacitor
 - During pre-heating: $T_p \leq 110 \text{ }^\circ\text{C}$
 - During soldering: $T_s \leq 120 \text{ }^\circ\text{C}$, $t_s \leq 45 \text{ s}$
- MKT capacitor
 - During pre-heating: $T_p \leq 125 \text{ }^\circ\text{C}$
 - During soldering: $T_s \leq 160 \text{ }^\circ\text{C}$, $t_s \leq 45 \text{ s}$

When SMD components are used together with leaded ones, the film capacitors should not pass into the SMD adhesive curing oven. The leaded components should be assembled after the SMD curing step.

Leaded film capacitors are not suitable for reflow soldering.

In order to ensure proper conditions for manual or selective soldering, the body temperature of the capacitor (T_s) must be $\leq 120 \text{ }^\circ\text{C}$.

One recommended condition for manual soldering is that the tip of the soldering iron should be $< 360 \text{ }^\circ\text{C}$ and the soldering contact time should be no longer than 3 seconds.

For uncoated MKT capacitors with lead spacings $\leq 10 \text{ mm}$ (B32560/B32561) the following measures are recommended:

- pre-heating to not more than $110 \text{ }^\circ\text{C}$ in the preheater phase
- rapid cooling after soldering

Please refer to EPCOS Film Capacitor Data Book in case more details are needed.



B32656S, B32658S

Snubber (wound)

Cautions and warnings

- Do not exceed the upper category temperature (UCT).
- Do not apply any mechanical stress to the capacitor terminals.
- Avoid any compressive, tensile or flexural stress.
- Do not move the capacitor after it has been soldered to the PC board.
- Do not pick up the PC board by the soldered capacitor.
- Do not place the capacitor on a PC board whose PTH hole spacing differs from the specified lead spacing.
- Do not exceed the specified time or temperature limits during soldering.
- Avoid external energy inputs, such as fire or electricity.
- Avoid overload of the capacitors.
- Consult us if application is with severe temperature and humidity condition.
- There are no serviceable or repairable parts inside the capacitor. Opening the capacitor or any attempts to open or repair the capacitor will void the warranty and liability of EPCOS.
- Please note that the standards referred to in this publication may have been revised in the meantime.

The table below summarizes the safety instructions that must always be observed. A detailed description can be found in the relevant sections of the chapters "General technical information" and "Mounting guidelines".

| Topic | Safety information | Reference chapter "General technical information" |
|-------------------------|---|--|
| Storage conditions | Make sure that capacitors are stored within the specified range of time, temperature and humidity conditions. | 4.5 "Storage conditions" |
| Flammability | Avoid external energy, such as fire or electricity (passive flammability), avoid overload of the capacitors (active flammability) and consider the flammability of materials. | 5.3 "Flammability" |
| Resistance to vibration | Do not exceed the tested ability to withstand vibration. The capacitors are tested to IEC 60068-2-6:2007. EPCOS offers film capacitors specially designed for operation under more severe vibration regimes such as those found in automotive applications. Consult our catalog "Film Capacitors for Automotive Electronics". | 5.2 "Resistance to vibration" |

| Topic | Safety information | Reference chapter "Mounting guidelines" |
|-----------|--|--|
| Soldering | Do not exceed the specified time or temperature limits during soldering. | 1 "Soldering" |
| Cleaning | Use only suitable solvents for cleaning capacitors. | 2 "Cleaning" |

B32656S, B32658S

Snubber (wound)



| Topic | Safety information | Reference chapter "Mounting guidelines" |
|--|---|--|
| Embedding of capacitors in finished assemblies | When embedding finished circuit assemblies in plastic resins, chemical and thermal influences must be taken into account. Caution: Consult us first, if you also wish to embed other uncoated component types! | 3 "Embedding of capacitors in finished assemblies" |

Display of ordering codes for EPCOS products

The ordering code for one and the same product can be represented differently in data sheets, data books, other publications and the website of EPCOS, or in order-related documents such as shipping notes, order confirmations and product labels. **The varying representations of the ordering codes are due to different processes employed and do not affect the specifications of the respective products.** Detailed information can be found on the Internet under www.epcos.com/orderingcodes.



B32656S, B32658S

Snubber (wound)

Symbols and terms

| Symbol | English | German |
|----------------------|---|---|
| α | Heat transfer coefficient | Wärmeübergangszahl |
| α_C | Temperature coefficient of capacitance | Temperaturkoeffizient der Kapazität |
| A | Capacitor surface area | Kondensatoroberfläche |
| β_C | Humidity coefficient of capacitance | Feuchtekoeffizient der Kapazität |
| C | Capacitance | Kapazität |
| C_R | Rated capacitance | Nennkapazität |
| ΔC | Absolute capacitance change | Absolute Kapazitätsänderung |
| $\Delta C/C$ | Relative capacitance change (relative deviation of actual value) | Relative Kapazitätsänderung (relative Abweichung vom Ist-Wert) |
| $\Delta C/C_R$ | Capacitance tolerance (relative deviation from rated capacitance) | Kapazitätstoleranz (relative Abweichung vom Nennwert) |
| dt | Time differential | Differentielle Zeit |
| Δt | Time interval | Zeitintervall |
| ΔT | Absolute temperature change (self-heating) | Absolute Temperaturänderung (Selbsterwärmung) |
| $\Delta \tan \delta$ | Absolute change of dissipation factor | Absolute Änderung des Verlustfaktors |
| ΔV | Absolute voltage change | Absolute Spannungsänderung |
| dV/dt | Time differential of voltage function (rate of voltage rise) | Differentielle Spannungsänderung (Spannungsflankensteilheit) |
| $\Delta V/\Delta t$ | Voltage change per time interval | Spannungsänderung pro Zeitintervall |
| E | Activation energy for diffusion | Aktivierungsenergie zur Diffusion |
| ESL | Self-inductance | Eigeninduktivität |
| ESR | Equivalent series resistance | Ersatz-Serienwiderstand |
| f | Frequency | Frequenz |
| f_1 | Frequency limit for reducing permissible AC voltage due to thermal limits | Grenzfrequenz für thermisch bedingte Reduzierung der zulässigen Wechselspannung |
| f_2 | Frequency limit for reducing permissible AC voltage due to current limit | Grenzfrequenz für strombedingte Reduzierung der zulässigen Wechselspannung |
| f_r | Resonant frequency | Resonanzfrequenz |
| F_D | Thermal acceleration factor for diffusion | Therm. Beschleunigungsfaktor zur Diffusion |
| F_T | Derating factor | Deratingfaktor |
| i | Current (peak) | Stromspitze |
| I_C | Category current (max. continuous current) | Kategoriestrom (max. Dauerstrom) |



| Symbol | English | German |
|------------------|--|---|
| I_{RMS} | (Sinusoidal) alternating current, root-mean-square value | (Sinusförmiger) Wechselstrom |
| i_z | Capacitance drift | Inkonstanz der Kapazität |
| k_0 | Pulse characteristic | Impuls Kennwert |
| L_S | Series inductance | Serieninduktivität |
| λ | Failure rate | Ausfallrate |
| λ_0 | Constant failure rate during useful service life | Konstante Ausfallrate in der Nutzungsphase |
| λ_{test} | Failure rate, determined by tests | Experimentell ermittelte Ausfallrate |
| P_{diss} | Dissipated power | Abgegebene Verlustleistung |
| P_{gen} | Generated power | Erzeugte Verlustleistung |
| Q | Heat energy | Wärmeenergie |
| ρ | Density of water vapor in air | Dichte von Wasserdampf in Luft |
| R | Universal molar constant for gases | Allg. Molarkonstante für Gas |
| R | Ohmic resistance of discharge circuit | Ohmscher Widerstand des Entladekreises |
| R_i | Internal resistance | Innenwiderstand |
| R_{ins} | Insulation resistance | Isolationswiderstand |
| R_P | Parallel resistance | Parallelwiderstand |
| R_S | Series resistance | Serienwiderstand |
| S | severity (humidity test) | Schärfegrad (Feuchtetest) |
| t | Time | Zeit |
| T | Temperature | Temperatur |
| τ | Time constant | Zeitkonstante |
| $\tan \delta$ | Dissipation factor | Verlustfaktor |
| $\tan \delta_D$ | Dielectric component of dissipation factor | Dielektrischer Anteil des Verlustfaktors |
| $\tan \delta_P$ | Parallel component of dissipation factor | Parallelanteil des Verlustfaktors |
| $\tan \delta_S$ | Series component of dissipation factor | Serienanteil des Verlustfaktors |
| T_A | Temperature of the air surrounding the component | Temperatur der Luft, die das Bauteil umgibt |
| T_{max} | Upper category temperature | Obere Kategorietemperatur |
| T_{min} | Lower category temperature | Untere Kategorietemperatur |
| t_{OL} | Operating life at operating temperature and voltage | Betriebszeit bei Betriebstemperatur und -spannung |
| T_{op} | Operating temperature, $T_A + \Delta T$ | Betriebstemperatur, $T_A + \Delta T$ |
| T_R | Rated temperature | Nenntemperatur |
| T_{ref} | Reference temperature | Referenztemperatur |
| t_{SL} | Reference service life | Referenz-Lebensdauer |

B32656S, B32658S
Snubber (wound)

| Symbol | English | German |
|-------------|---|---|
| V_{AC} | AC voltage | Wechselspannung |
| V_C | Category voltage | Kategorie spannung |
| $V_{C,RMS}$ | Category AC voltage | (Sinusförmige) Kategorie-Wechselspannung |
| V_{CD} | Corona-discharge onset voltage | Teilentlade-Einsatzspannung |
| V_{ch} | Charging voltage | Ladespannung |
| V_{DC} | DC voltage | Gleichspannung |
| V_{FB} | Fly-back capacitor voltage | Spannung (Flyback) |
| V_i | Input voltage | Eingangsspannung |
| V_o | Output voltage | Ausgangsspannung |
| V_{op} | Operating voltage | Betriebsspannung |
| V_p | Peak pulse voltage | Impuls-Spitzen spannung |
| V_{pp} | Peak-to-peak voltage Impedance | Spannungshub |
| V_R | Rated voltage | Nennspannung |
| \hat{V}_R | Amplitude of rated AC voltage | Amplitude der Nenn-Wechselspannung |
| V_{RMS} | (Sinusoidal) alternating voltage, root-mean-square value | (Sinusförmige) Wechselspannung |
| V_{SC} | S-correction voltage | Spannung bei Anwendung "S-correction" |
| V_{sn} | Snubber capacitor voltage | Spannung bei Anwendung "Beschaltung" |
| Z | Impedance | Scheinwiderstand |
| e | Lead spacing | Rastermaß |

Important notes

The following applies to all products named in this publication:

1. Some parts of this publication contain **statements about the suitability of our products for certain areas of application**. These statements are based on our knowledge of typical requirements that are often placed on our products in the areas of application concerned. We nevertheless expressly point out **that such statements cannot be regarded as binding statements about the suitability of our products for a particular customer application**. As a rule, EPCOS is either unfamiliar with individual customer applications or less familiar with them than the customers themselves. For these reasons, it is always ultimately incumbent on the customer to check and decide whether an EPCOS product with the properties described in the product specification is suitable for use in a particular customer application.
2. We also point out that **in individual cases, a malfunction of electronic components or failure before the end of their usual service life cannot be completely ruled out in the current state of the art, even if they are operated as specified**. In customer applications requiring a very high level of operational safety and especially in customer applications in which the malfunction or failure of an electronic component could endanger human life or health (e.g. in accident prevention or lifesaving systems), it must therefore be ensured by means of suitable design of the customer application or other action taken by the customer (e.g. installation of protective circuitry or redundancy) that no injury or damage is sustained by third parties in the event of malfunction or failure of an electronic component.
3. **The warnings, cautions and product-specific notes must be observed.**
4. In order to satisfy certain technical requirements, **some of the products described in this publication may contain substances subject to restrictions in certain jurisdictions (e.g. because they are classed as hazardous)**. Useful information on this will be found in our Material Data Sheets on the Internet (www.epcos.com/material). Should you have any more detailed questions, please contact our sales offices.
5. We constantly strive to improve our products. Consequently, **the products described in this publication may change from time to time**. The same is true of the corresponding product specifications. Please check therefore to what extent product descriptions and specifications contained in this publication are still applicable before or when you place an order. We also **reserve the right to discontinue production and delivery of products**. Consequently, we cannot guarantee that all products named in this publication will always be available. The aforementioned does not apply in the case of individual agreements deviating from the foregoing for customer-specific products.
6. Unless otherwise agreed in individual contracts, **all orders are subject to the current version of the "General Terms of Delivery for Products and Services in the Electrical Industry" published by the German Electrical and Electronics Industry Association (ZVEI)**.

Important notes

7. **Our manufacturing sites serving the automotive business apply the IATF 16949 standard.** The IATF certifications confirm our compliance with requirements regarding the quality management system in the automotive industry. Referring to customer requirements and customer specific requirements (“CSR”) TDK always has and will continue to have the policy of respecting individual agreements. Even if IATF 16949 may appear to support the acceptance of unilateral requirements, we hereby like to emphasize that **only requirements mutually agreed upon can and will be implemented in our Quality Management System.** For clarification purposes we like to point out that obligations from IATF 16949 shall only become legally binding if individually agreed upon.
8. The trade names EPCOS, CeraCharge, CeraDiode, CeraLink, CeraPad, CeraPlas, CSMP, CTVS, DeltaCap, DigiSiMic, ExoCore, FilterCap, FormFit, LeaXield, MiniBlue, MiniCell, MKD, MKK, MotorCap, PCC, PhaseCap, PhaseCube, PhaseMod, PhiCap, PowerHap, PQSine, PQvar, SIFERRIT, SIFI, SIKOREL, SilverCap, SIMDAD, SiMic, SIMID, SineFormer, SIOV, ThermoFuse, WindCap are **trademarks registered or pending** in Europe and in other countries. Further information will be found on the Internet at www.epcos.com/trademarks.

Release 2018-06

Mouser Electronics

Authorized Distributor

Click to View Pricing, Inventory, Delivery & Lifecycle Information:

EPCOS / TDK:

[B32656S105J561](#) [B32656S105J564](#) [B32656S105K562](#) [B32656S105K563](#) [B32656S105K565](#) [B32656S125J561](#)
[B32656S125K561](#) [B32656S125K562](#) [B32656S125K563](#) [B32656S125K564](#) [B32656S125K565](#) [B32656S155K561](#)
[B32656S155K562](#) [B32656S155K563](#) [B32656S185J561](#) [B32656S185K561](#) [B32656S474J565](#) [B32656S474K563](#)
[B32656S474K564](#) [B32656S474K565](#) [B32656S684J564](#) [B32656S684J565](#) [B32656S684K563](#) [B32656S684K565](#)
[B32656S7145K561](#) [B32656S8255K563](#) [B32656S7474K561](#) [B32656S0105K561](#) [B32656S0105K562](#)
[B32656S0105K563](#) [B32656S0105K564](#) [B32656S0105K565](#) [B32656S0125K561](#) [B32656S0125K562](#)
[B32656S0125K563](#) [B32656S0125K564](#) [B32656S0125K565](#) [B32656S0155K561](#) [B32656S0155K562](#)
[B32656S0155K563](#) [B32656S0474K563](#) [B32656S0474K564](#) [B32656S0474K565](#) [B32656S0684K563](#)
[B32656S0684K564](#) [B32656S0684K565](#) [B32656S7105K561](#) [B32656S7105K562](#) [B32656S7105K563](#)
[B32656S7224K563](#) [B32656S7224K564](#) [B32656S7224K565](#) [B32656S7684K561](#) [B32656S7684K562](#)
[B32656S7684K563](#) [B32656S7684K564](#) [B32656S7684K565](#) [B32656S8155J561](#) [B32656S8225J561](#)
[B32656S7474J564](#) [B32656S7474J565](#) [B32656S7105J561](#) [B32656S2104J564](#) [B32656S2224J561](#)
[B32656S2474J561](#) [B32656S8824K565](#) [B32656S8155K561](#) [B32656S8225K561](#) [B32656S7334K565](#)
[B32656S7564K561](#) [B32656S7564K562](#) [B32656S7125K561](#) [B32656S7125K562](#) [B32656S1334K561](#)
[B32656S1334K565](#) [B32656S1474K561](#) [B32656S2104K564](#) [B32656S2224K561](#) [B32656S2334K561](#)
[B32656S2474K561](#) [B32656S2474K562](#) [B32656S1684K561](#) [B32656S1684K563](#) [B32656S105K561](#)
[B32656S105K564](#) [B32656S155J561](#) [B32656S205J561](#) [B32656S684K564](#) [B32656S8255K561](#) [B32656S8255K562](#)
[B32656S1224K565](#) [B32656S7105J563](#) [B32656S7474K565](#) [B32656S8185K562](#) [B32656S1104K564](#)
[B32656S2104J563](#) [B32656S7125K563](#) [B32656S8125K565](#) [B32656S2104K563](#) [B32656S2154K563](#)

Компания «Океан Электроники» предлагает заключение долгосрочных отношений при поставках импортных электронных компонентов на взаимовыгодных условиях!

Наши преимущества:

- Поставка оригинальных импортных электронных компонентов напрямую с производств Америки, Европы и Азии, а так же с крупнейших складов мира;
- Широкая линейка поставок активных и пассивных импортных электронных компонентов (более 30 млн. наименований);
- Поставка сложных, дефицитных, либо снятых с производства позиций;
- Оперативные сроки поставки под заказ (от 5 рабочих дней);
- Экспресс доставка в любую точку России;
- Помощь Конструкторского Отдела и консультации квалифицированных инженеров;
- Техническая поддержка проекта, помощь в подборе аналогов, поставка прототипов;
- Поставка электронных компонентов под контролем ВП;
- Система менеджмента качества сертифицирована по Международному стандарту ISO 9001;
- При необходимости вся продукция военного и аэрокосмического назначения проходит испытания и сертификацию в лаборатории (по согласованию с заказчиком);
- Поставка специализированных компонентов военного и аэрокосмического уровня качества (Xilinx, Altera, Analog Devices, Intersil, Interpoint, Microsemi, Actel, Aeroflex, Peregrine, VPT, Syfer, Eurofarad, Texas Instruments, MS Kennedy, Miteq, Cobham, E2V, MA-COM, Hittite, Mini-Circuits, General Dynamics и др.);

Компания «Океан Электроники» является официальным дистрибьютором и эксклюзивным представителем в России одного из крупнейших производителей разъемов военного и аэрокосмического назначения «JONHON», а так же официальным дистрибьютором и эксклюзивным представителем в России производителя высокотехнологичных и надежных решений для передачи СВЧ сигналов «FORSTAR».



JONHON

«JONHON» (основан в 1970 г.)

Разъемы специального, военного и аэрокосмического назначения:

(Применяются в военной, авиационной, аэрокосмической, морской, железнодорожной, горно- и нефтедобывающей отраслях промышленности)

«FORSTAR» (основан в 1998 г.)

ВЧ соединители, коаксиальные кабели,
кабельные сборки и микроволновые компоненты:

(Применяются в телекоммуникациях гражданского и специального назначения, в средствах связи, РЛС, а так же военной, авиационной и аэрокосмической отраслях промышленности).



Телефон: 8 (812) 309-75-97 (многоканальный)

Факс: 8 (812) 320-03-32

Электронная почта: ocean@oceanchips.ru

Web: <http://oceanchips.ru/>

Адрес: 198099, г. Санкт-Петербург, ул. Калинина, д. 2, корп. 4, лит. А