

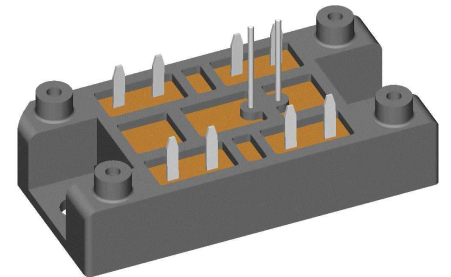
Standard Rectifier Module

3~ Rectifier	Brake Chopper
$V_{RRM} = 1600 \text{ V}$	$V_{CES} = 1200 \text{ V}$
$I_{DAV} = 75 \text{ A}$	$I_{C25} = 58 \text{ A}$
$I_{FSM} = 600 \text{ A}$	$V_{CE(sat)} = 1.85 \text{ V}$

3~ Rectifier Bridge + Brake Unit + NTC

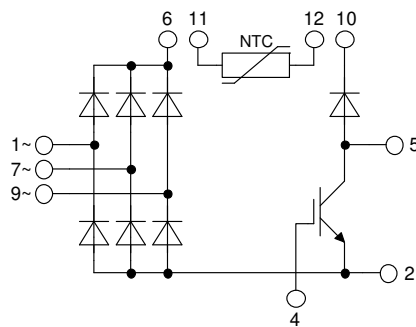
Part number

VUB72-16NOXT



Backside: isolated

 E72873



Features / Advantages:

- Package with DCB ceramic base plate
- Improved temperature and power cycling
- Planar passivated chips
- Very low forward voltage drop
- Very low leakage current
- NTC

Applications:

- 3~ Rectifier with brake unit for drive inverters

Package: V1-A-Pack

- Isolation Voltage: 3600 V~
- Industry standard outline
- RoHS compliant
- Soldering pins for PCB mounting
- Height: 17 mm
- Base plate: DCB ceramic
- Reduced weight
- Advanced power cycling

Disclaimer Notice

Information furnished is believed to be accurate and reliable. However, users should independently evaluate the suitability of and test each product selected for their own applications. Littelfuse products are not designed for, and may not be used in, all applications. Read complete Disclaimer Notice at www.littelfuse.com/disclaimer-electronics.

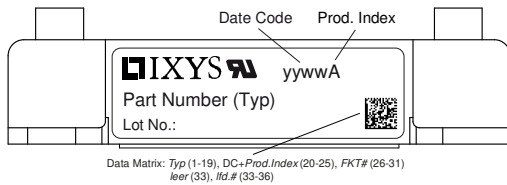


Rectifier				Ratings			
Symbol	Definition	Conditions		min.	typ.	max.	Unit
V_{RSM}	max. non-repetitive reverse blocking voltage					1700	V
V_{RRM}	max. repetitive reverse blocking voltage					1600	V
I_R	reverse current	$V_R = 1600$ V		$T_{VJ} = 25^\circ\text{C}$		40	μA
		$V_R = 1600$ V		$T_{VJ} = 150^\circ\text{C}$		1.5	mA
V_F	forward voltage drop	$I_F = 25$ A		$T_{VJ} = 25^\circ\text{C}$		1.10	V
		$I_F = 75$ A				1.38	V
		$I_F = 25$ A		$T_{VJ} = 125^\circ\text{C}$		1.01	V
		$I_F = 75$ A				1.37	V
I_{DAV}	bridge output current	$T_C = 110^\circ\text{C}$		$T_{VJ} = 150^\circ\text{C}$		75	A
		rectangular	$d = \frac{1}{3}$				
V_{FO}	threshold voltage			$T_{VJ} = 150^\circ\text{C}$		0.79	V
r_F	slope resistance					7.7	m Ω
						} for power loss calculation only	
R_{thJC}	thermal resistance junction to case					1.1	K/W
R_{thCH}	thermal resistance case to heatsink				0.3		K/W
P_{tot}	total power dissipation			$T_C = 25^\circ\text{C}$		110	W
I_{FSM}	max. forward surge current	$t = 10$ ms; (50 Hz), sine		$T_{VJ} = 45^\circ\text{C}$		600	A
		$t = 8,3$ ms; (60 Hz), sine		$V_R = 0$ V		650	A
		$t = 10$ ms; (50 Hz), sine		$T_{VJ} = 150^\circ\text{C}$		510	A
		$t = 8,3$ ms; (60 Hz), sine		$V_R = 0$ V		550	A
I^2t	value for fusing	$t = 10$ ms; (50 Hz), sine		$T_{VJ} = 45^\circ\text{C}$		1.80	kA ² s
		$t = 8,3$ ms; (60 Hz), sine		$V_R = 0$ V		1.76	kA ² s
		$t = 10$ ms; (50 Hz), sine		$T_{VJ} = 150^\circ\text{C}$		1.30	kA ² s
		$t = 8,3$ ms; (60 Hz), sine		$V_R = 0$ V		1.26	kA ² s
C_J	junction capacitance	$V_R = 400$ V; $f = 1$ MHz		$T_{VJ} = 25^\circ\text{C}$		19	pF

Brake IGBT				Ratings					
Symbol	Definition	Conditions	min.	typ.	max.	Unit			
V_{CES}	collector emitter voltage	$T_{VJ} = 25^{\circ}\text{C}$			1200	V			
V_{GES}	max. DC gate voltage				± 20	V			
V_{GEM}	max. transient gate emitter voltage				± 30	V			
I_{C25}	collector current	$T_C = 25^{\circ}\text{C}$			58	A			
I_{C80}		$T_C = 80^{\circ}\text{C}$			40	A			
P_{tot}	total power dissipation	$T_C = 25^{\circ}\text{C}$			195	W			
$V_{CE(sat)}$	collector emitter saturation voltage	$I_C = 35\text{ A}; V_{GE} = 15\text{ V}$			1.85	V			
					2.15	V			
$V_{GE(th)}$	gate emitter threshold voltage	$I_C = 2\text{ mA}; V_{GE} = V_{CE}$	5.4	5.9	6.5	V			
I_{CES}	collector emitter leakage current	$V_{CE} = V_{CES}; V_{GE} = 0\text{ V}$			0.1	mA			
					0.1	mA			
I_{GES}	gate emitter leakage current	$V_{GE} = \pm 20\text{ V}$			500	nA			
$Q_{G(on)}$	total gate charge	$V_{CE} = 600\text{ V}; V_{GE} = 15\text{ V}; I_C = 35\text{ A}$		110		nC			
$t_{d(on)}$	turn-on delay time	inductive load $V_{CE} = 600\text{ V}; I_C = 35\text{ A}$ $V_{GE} = \pm 15\text{ V}; R_G = 27\ \Omega$							
t_r	current rise time						$T_{VJ} = 125^{\circ}\text{C}$	70	ns
$t_{d(off)}$	turn-off delay time						40	ns	
t_f	current fall time						250	ns	
E_{on}	turn-on energy per pulse						100	ns	
E_{off}	turn-off energy per pulse						3.8	mJ	
E_{off}		4.1	mJ						
RBSOA	reverse bias safe operating area	$V_{GE} = \pm 15\text{ V}; R_G = 27\ \Omega$							
I_{CM}		$V_{CEK} = 1200\text{ V}$			105	A			
SCSOA	short circuit safe operating area	$V_{CEK} = 1200\text{ V}$							
t_{SC}	short circuit duration	$V_{CE} = 900\text{ V}; V_{GE} = \pm 15$			10	μs			
I_{SC}	short circuit current	$R_G = 27\ \Omega$; non-repetitive		140		A			
R_{thJC}	thermal resistance junction to case				0.65	K/W			
R_{thCH}	thermal resistance case to heatsink			0.25		K/W			
Brake Diode									
V_{RRM}	max. repetitive reverse voltage	$T_{VJ} = 25^{\circ}\text{C}$			1200	V			
I_{F25}	forward current	$T_C = 25^{\circ}\text{C}$			31	A			
I_{F80}		$T_C = 80^{\circ}\text{C}$			21	A			
V_F	forward voltage	$I_F = 25\text{ A}$			2.97	V			
					2.43	V			
I_R	reverse current	$V_R = V_{RRM}$			0.1	mA			
					0.5	mA			
Q_{rr}	reverse recovery charge	$V_R = 600\text{ V}$ $-di_f/dt = 400\text{ A}/\mu\text{s}$ $I_F = 25\text{ A}; V_{GE} = 0\text{ V}$							
I_{RM}	max. reverse recovery current						$T_{VJ} = 125^{\circ}\text{C}$	1.2	μC
t_{rr}	reverse recovery time						18	A	
R_{thJC}	thermal resistance junction to case				1.6	K/W			
R_{thCH}	thermal resistance case to heatsink			0.55		K/W			



Package V1-A-Pack				Ratings			
Symbol	Definition	Conditions	min.	typ.	max.	Unit	
I_{RMS}	RMS current	per terminal			100	A	
T_{VJ}	virtual junction temperature		-40		150	°C	
T_{op}	operation temperature		-40		125	°C	
T_{stg}	storage temperature		-40		125	°C	
Weight				37		g	
M_D	mounting torque		2		2.5	Nm	
$d_{Spp/App}$	creepage distance on surface / striking distance through air	terminal to terminal	6.0			mm	
$d_{Spb/Apb}$		terminal to backside	12.0			mm	
V_{ISOL}	isolation voltage	t = 1 second 50/60 Hz, RMS; $I_{ISOL} \leq 1$ mA	3600			V	
		t = 1 minute	3000			V	



Ordering	Ordering Number	Marking on Product	Delivery Mode	Quantity	Code No.
Standard	VUB72-16NOXT	VUB72-16NOXT	Blister	24	515894

Similar Part	Package	Voltage class
VUB72-12NOXT	V1-A-Pack	1200

Temperature Sensor NTC

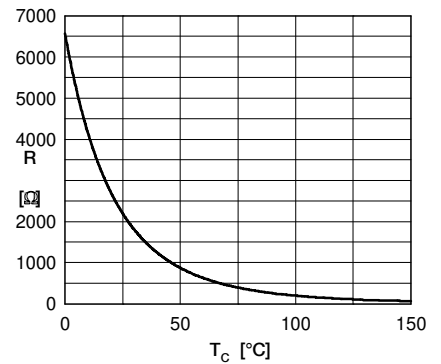
Symbol	Definition	Conditions	min.	typ.	max.	Unit
R_{25}	resistance	$T_{VJ} = 25^\circ$	2.13	2.2	2.27	kΩ
$B_{25/50}$	temperature coefficient			3560		K

Equivalent Circuits for Simulation

* on die level

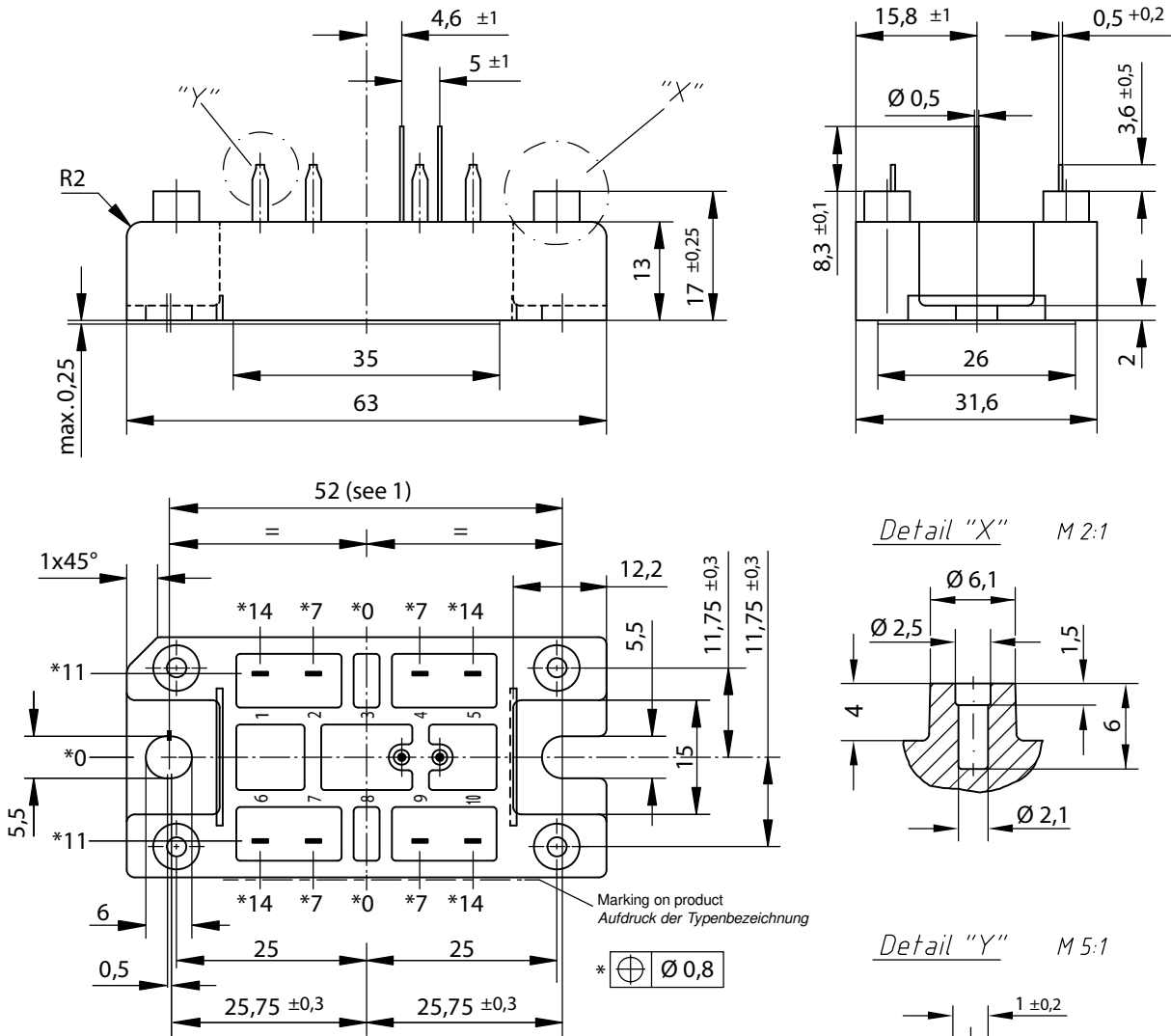
$T_{VJ} = 150^\circ\text{C}$

		Rectifier	Brake IGBT	Brake Diode	
V_0	threshold voltage	0.79	1.1	1.16	V
R_0	slope resistance *	6.5	40	43	mΩ



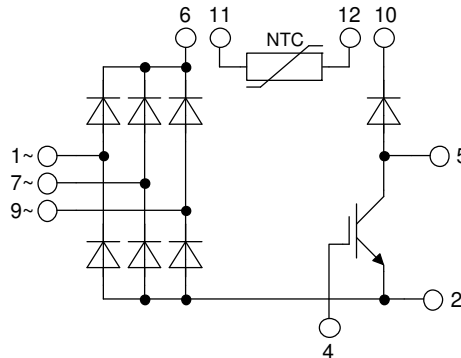


Outlines V1-A-Pack



Remarks / Bemerkungen:

1. Nominal distance mounting screws on heat sink: 52 mm / Nennabstand Befestigungsschrauben auf Kühlkörper: 52 mm
2. General tolerance / Allgmeintoleranz: DIN ISO 2768 - T1-c
3. Surface treatment of pins: tin plated (Sn) in hot dip / Oberflächenbehandlung der Pins: verzinkt (Sn) im Tauchbad
4. **Detail X:**
EJOT PT® self-tapping screws (dimension K25) to be recommended for mounting on PCB
selbstschneidende Schraube (Größe K25) empfohlen für die PCB-Montage
Take care on the maximum screw length according to board thickness and the maximum hole depth of 6 mm⁻¹
Bei der Wahl der Schraubenlänge die PCB-Dicke und die maximale Lochtiefe von 6mm beachten
Recommended mounting torque: 1.5 Nm / Empfohlenes Drehmoment: 1.5 Nm



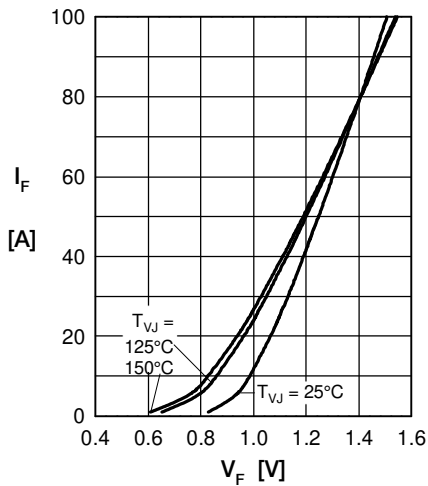
Rectifier


Fig. 1 Forward current vs. voltage drop per diode

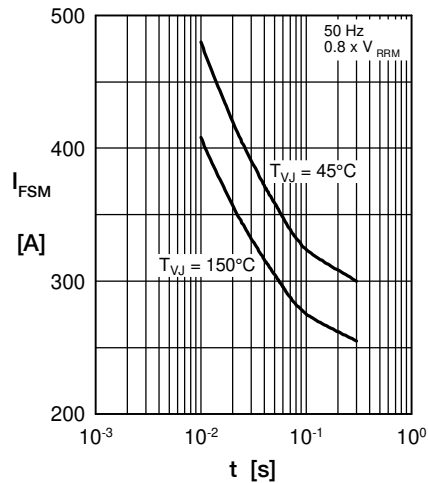


Fig. 2 Surge overload current vs. time per diode

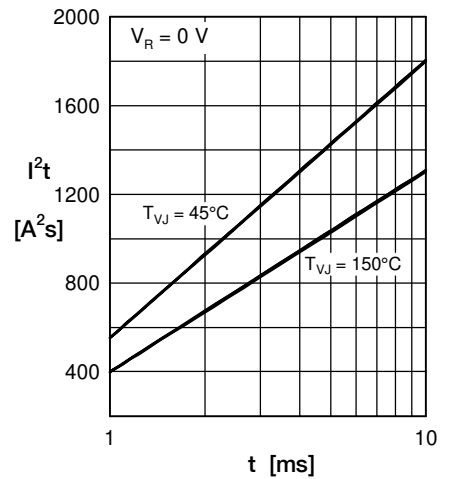
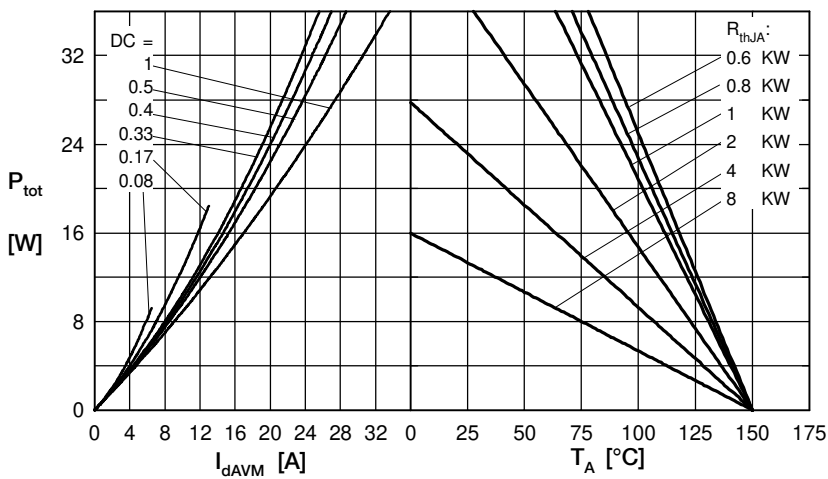

 Fig. 3 I^2t vs. time per diode


Fig. 4 Power dissipation vs. forward current and ambient temperature per diode

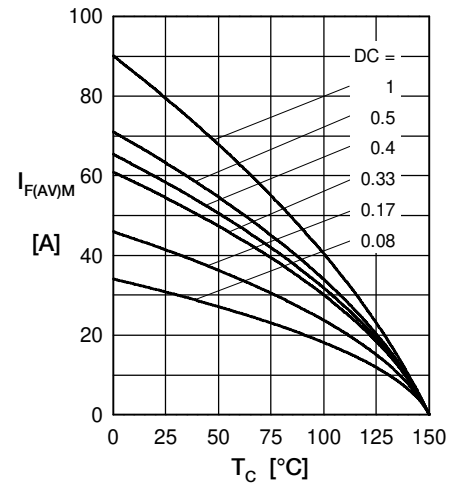


Fig. 5 Max. forward current vs. case temperature per diode

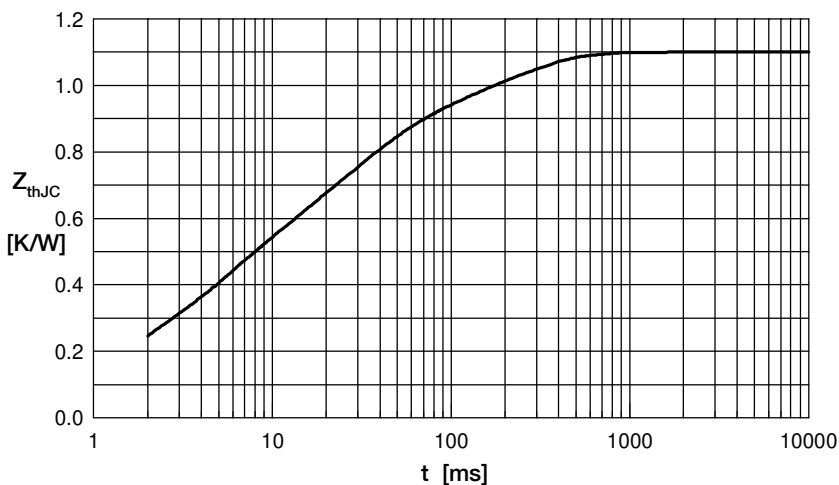


Fig. 6 Transient thermal impedance junction to case vs. time per diode

 Constants for Z_{thJC} calculation:

i	R_{th} (K/W)	t_i (s)
1	0.0607	0.0004
2	0.1230	0.00256
3	0.2305	0.0045
4	0.4230	0.0242
5	0.2628	0.1800

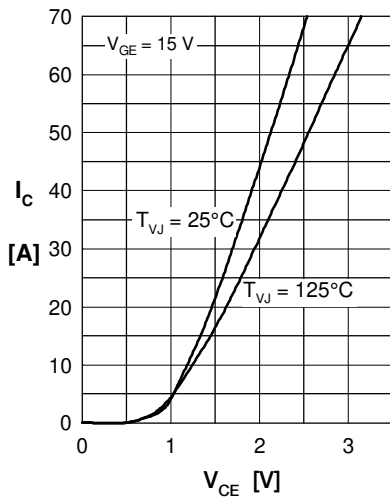
Brake IGBT


Fig. 1 Typ. output characteristics

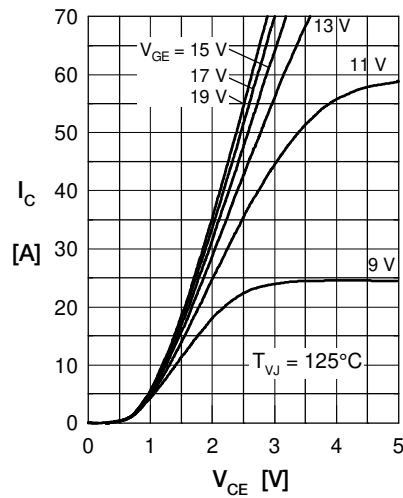


Fig. 2 Typ. output characteristics

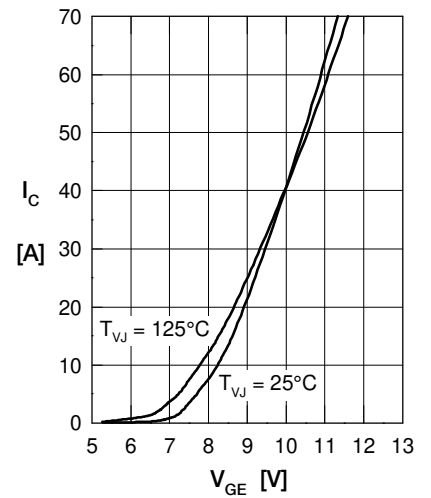


Fig. 3 Typ. transfer characteristics

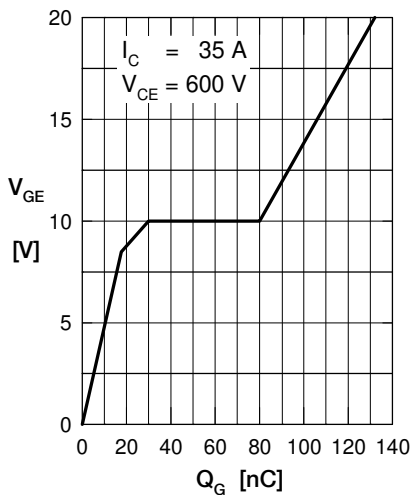


Fig. 4 Typ. turn-on gate charge

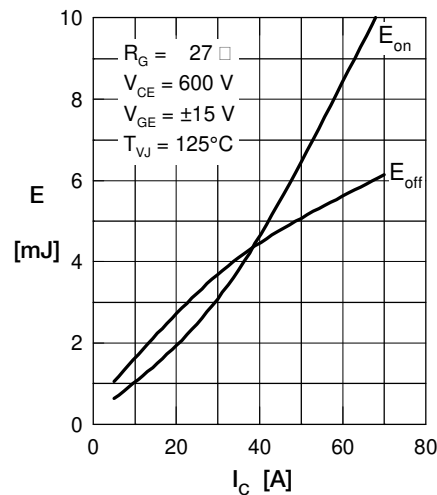


Fig. 5 Typ. switching energy versus collector current

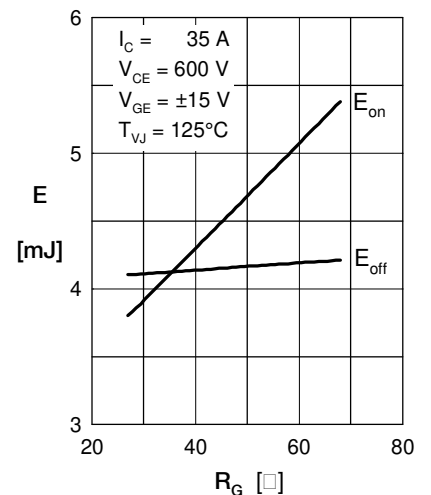


Fig. 6 Typ. switching energy versus gate resistance

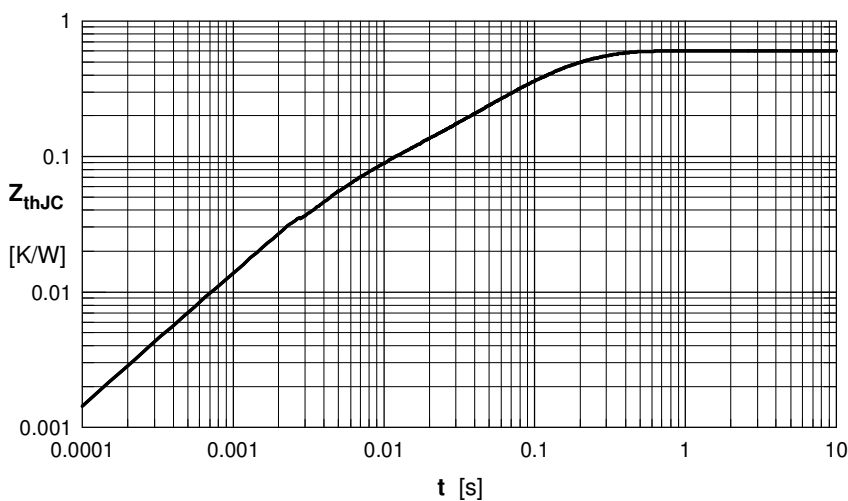


Fig. 7 Typ. transient thermal impedance

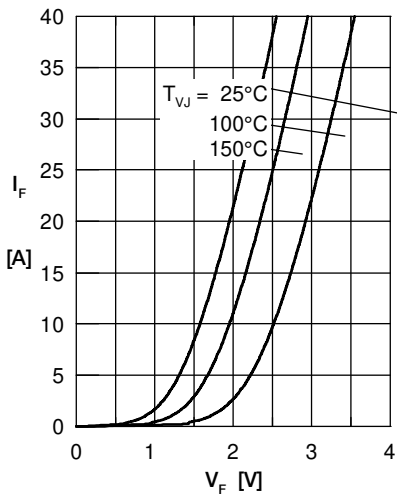
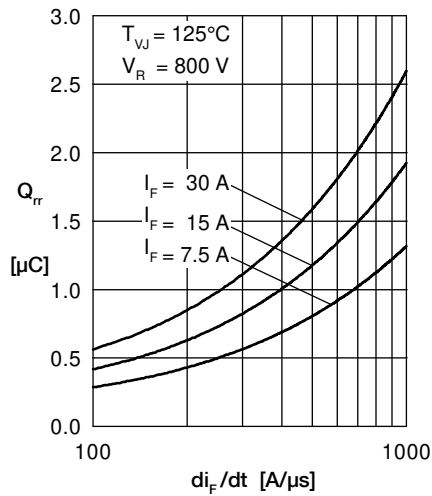
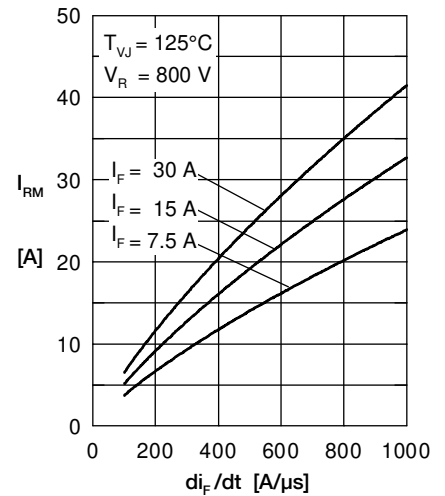
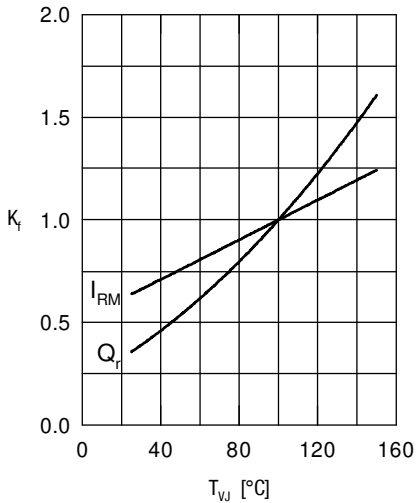
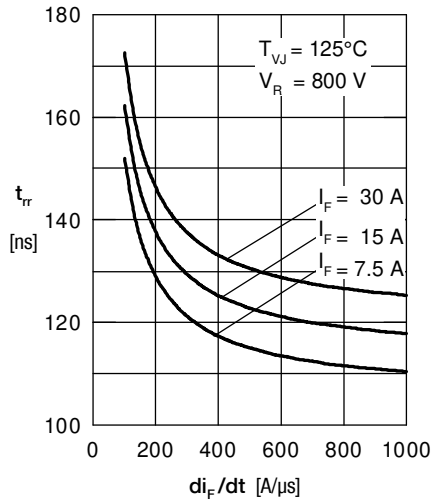
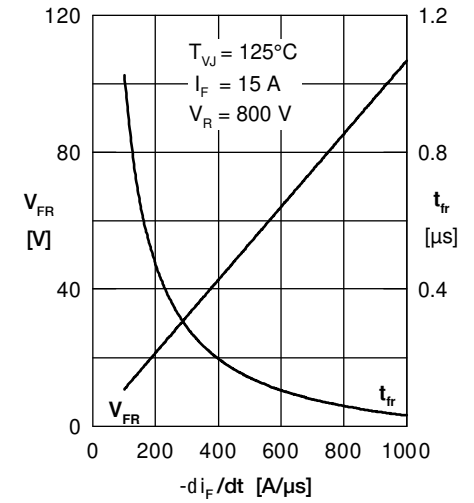
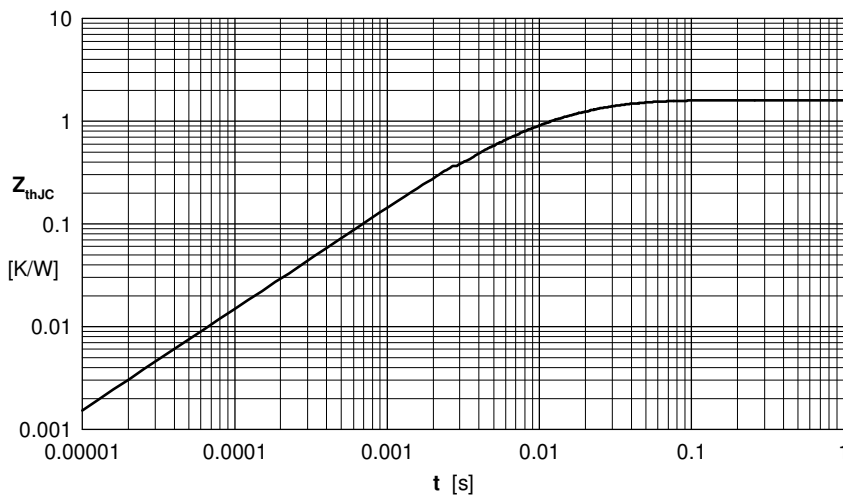
Brake Diode

 Fig. 1 Forward current I_F versus V_F

 Fig. 2 Typ. reverse recov. charge Q_{rr} versus di_F/dt

 Fig. 3 Typ. peak reverse current I_{RM} versus di_F/dt

 Fig. 4 Dynamic parameters Q_r , I_{RM} versus T_{VJ}

 Fig. 5 Typ. recovery time t_{rr} versus di_F/dt

 Fig. 6 Typ. peak forward voltage V_{FR} and t_{fr} versus di_F/dt


Fig. 7 Transient thermal impedance junction to case

Компания «Океан Электроники» предлагает заключение долгосрочных отношений при поставках импортных электронных компонентов на взаимовыгодных условиях!

Наши преимущества:

- Поставка оригинальных импортных электронных компонентов напрямую с производств Америки, Европы и Азии, а так же с крупнейших складов мира;
- Широкая линейка поставок активных и пассивных импортных электронных компонентов (более 30 млн. наименований);
- Поставка сложных, дефицитных, либо снятых с производства позиций;
- Оперативные сроки поставки под заказ (от 5 рабочих дней);
- Экспресс доставка в любую точку России;
- Помощь Конструкторского Отдела и консультации квалифицированных инженеров;
- Техническая поддержка проекта, помощь в подборе аналогов, поставка прототипов;
- Поставка электронных компонентов под контролем ВП;
- Система менеджмента качества сертифицирована по Международному стандарту ISO 9001;
- При необходимости вся продукция военного и аэрокосмического назначения проходит испытания и сертификацию в лаборатории (по согласованию с заказчиком);
- Поставка специализированных компонентов военного и аэрокосмического уровня качества (Xilinx, Altera, Analog Devices, Intersil, Interpoint, Microsemi, Actel, Aeroflex, Peregrine, VPT, Syfer, Eurofarad, Texas Instruments, MS Kennedy, Miteq, Cobham, E2V, MA-COM, Hittite, Mini-Circuits, General Dynamics и др.);

Компания «Океан Электроники» является официальным дистрибьютором и эксклюзивным представителем в России одного из крупнейших производителей разъемов военного и аэрокосмического назначения «JONHON», а так же официальным дистрибьютором и эксклюзивным представителем в России производителя высокотехнологичных и надежных решений для передачи СВЧ сигналов «FORSTAR».



JONHON

«JONHON» (основан в 1970 г.)

Разъемы специального, военного и аэрокосмического назначения:

(Применяются в военной, авиационной, аэрокосмической, морской, железнодорожной, горно- и нефтедобывающей отраслях промышленности)

«FORSTAR» (основан в 1998 г.)

ВЧ соединители, коаксиальные кабели, кабельные сборки и микроволновые компоненты:

(Применяются в телекоммуникациях гражданского и специального назначения, в средствах связи, РЛС, а так же военной, авиационной и аэрокосмической отраслях промышленности).



Телефон: 8 (812) 309-75-97 (многоканальный)

Факс: 8 (812) 320-03-32

Электронная почта: ocean@oceanchips.ru

Web: <http://oceanchips.ru/>

Адрес: 198099, г. Санкт-Петербург, ул. Калинина, д. 2, корп. 4, лит. А