



InGaP HBT 1.6 WATT POWER AMPLIFIER, 0.4 - 2.2 GHz

Typical Applications

The HMC453QS16G / HMC453QS16GE is ideal for applications requiring a high dynamic range amplifier:

- GSM, GPRS & EDGE
- CDMA & W-CDMA
- CATV/Cable Modem
- Fixed Wireless & WLL

Features

- Output IP3: +51 dBm
- 21.5 dB Gain @ 400 MHz
- 8 dB Gain @ 2100 MHz
- 45% PAE @ +32 dBm Pout
- +25 dBm CDMA2000 Channel Power@ -45 dBc ACP
- Single +5V Supply
- Integrated Power Control (VPD)
- QSOP16G SMT Package: 29.4 mm²

Functional Diagram

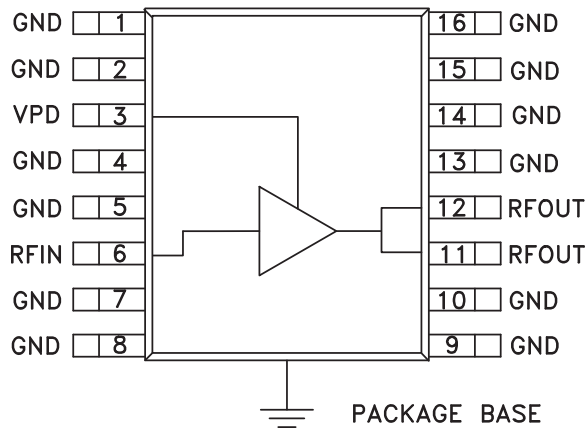

General Description

The HMC453QS16G & HMC453QS16GE are high dynamic range GaAs InGaP Heterojunction Bipolar Transistor (HBT) 1.6 watt MMIC power amplifiers operating between 0.4 and 2.2 GHz. Packaged in a miniature 16 lead QSOP plastic package, the amplifier gain is typically 21.5 dB at 0.4 GHz and 8 dB at 2.1 GHz. Utilizing a minimum number of external components and a single +5V supply, the amplifier output IP3 can be optimized to +47 dBm at 0.4 GHz or +51 dBm at 2.1 GHz. The power control (VPD) can be used for full power down or RF output power/current control. The high output IP3 and PAE make the HMC453QS16G(E) ideal power amplifiers for Cellular/PCS/3G, WLL, ISM and Fixed Wireless applications.

Electrical Specifications, $T_A = +25^\circ\text{C}$, $V_s = +5\text{V}$, $VPD = +5\text{V}$ [1]

Parameter	Min.	Typ.	Max.	Min.	Typ.	Max.	Min.	Typ.	Max.	Min.	Typ.	Max.	Min.	Typ.	Max.	Units
Frequency Range	400 - 410			450 - 496			810 - 960			1710 - 1990			2010 - 2170			MHz
Gain	19	21.5		18	20.5		12	15		6	9		6	8		dB
Gain Variation Over Temperature		0.012	0.02		0.012	0.02		0.012	0.02		0.012	0.02		0.012	0.02	dB / °C
Input Return Loss		12			15			12			10			15		dB
Output Return Loss		10			10			15			13			18		dB
Output Power for 1dB Compression (P1dB)	29	32		29	32		29	32		28.5	31.5		30	33		dBm
Saturated Output Power (Psat)		32.25			32.25			32.5			32			33.5		dBm
Output Third Order Intercept (IP3) [2]	44	47		47	50		46	49		44	50		48	51		dBm
Noise Figure		7			8.5			7			7.5			6.5		dB
Supply Current (Icq)		725			725			725			725			725		mA
Control Current (IPD)		12			12			12			12			12		mA

[1] Specifications and data reflect HMC453QS16G measured using the respective application circuits for each designated frequency band found herein. Contact the HMC Applications Group for assistance in optimizing performance for your application.

[2] Two-tone input power of -10 dBm per tone, 1 MHz spacing.



Broadband Gain & Return Loss @ 400 MHz

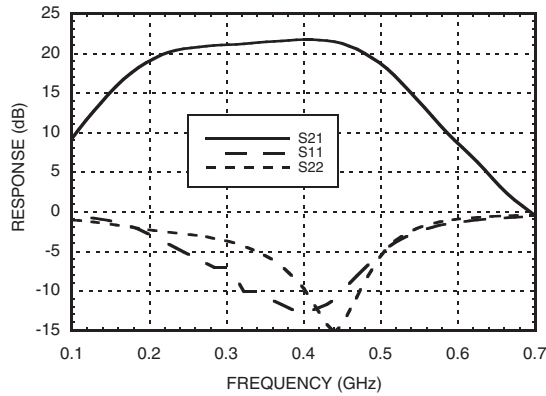

Gain vs. Temperature @ 400 MHz

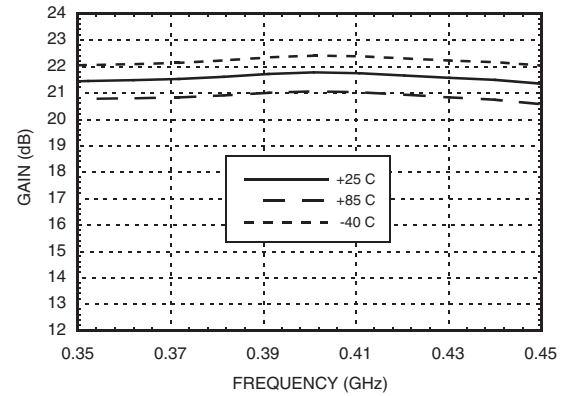

Input Return Loss vs. Temperature @ 400 MHz

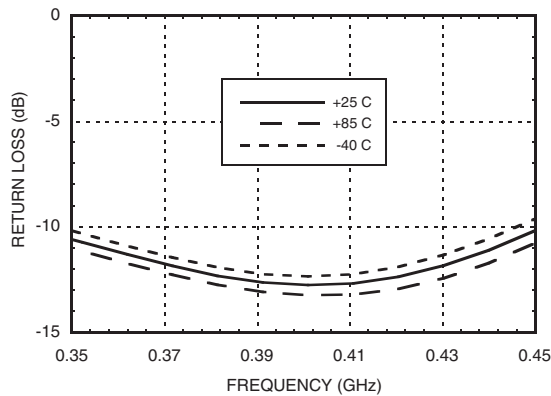

Output Return Loss vs. Temperature @ 400 MHz

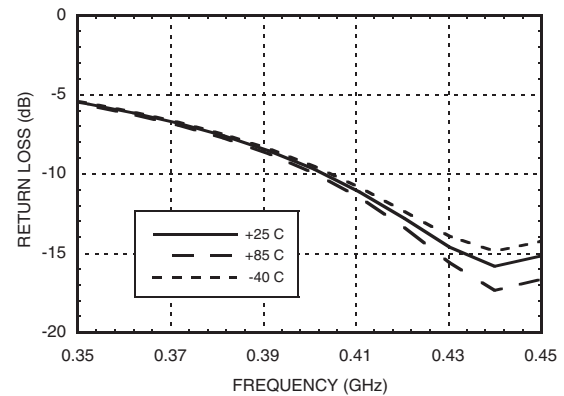

P1dB vs. Temperature @ 400 MHz

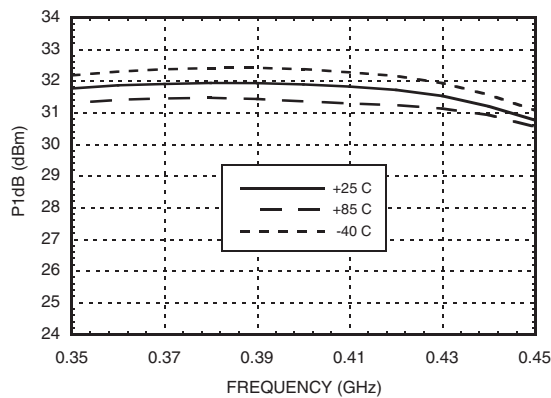

Psat vs. Temperature @ 400 MHz

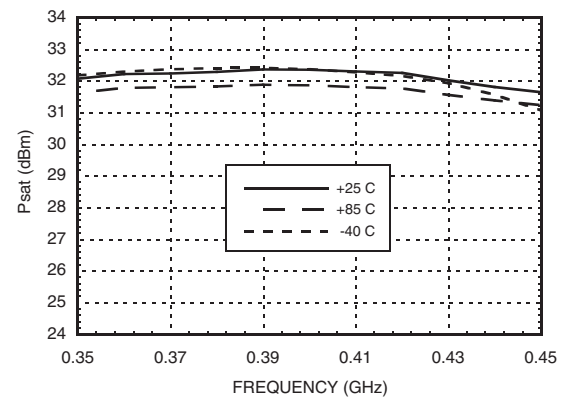

11

LINEAR & POWER AMPLIFIERS - SMT



v01.0205



HMC453QS16G / 453QS16GE

InGaP HBT 1.6 WATT POWER AMPLIFIER, 0.4 - 2.2 GHz

Output IP3 vs. Temperature @ 400 MHz

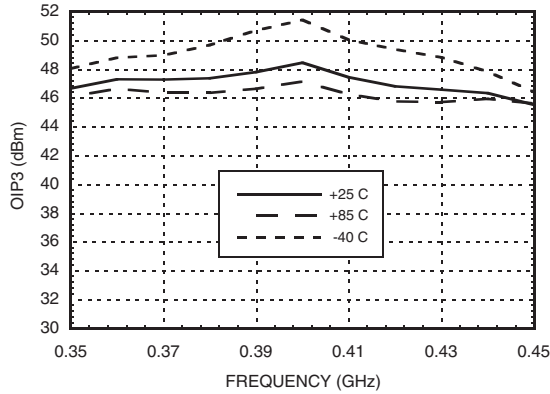

Noise Figure vs. Temperature @ 400 MHz

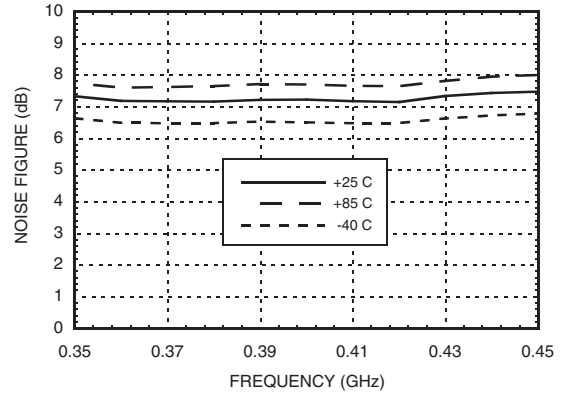

Reverse Isolation vs. Temperature @ 400 MHz

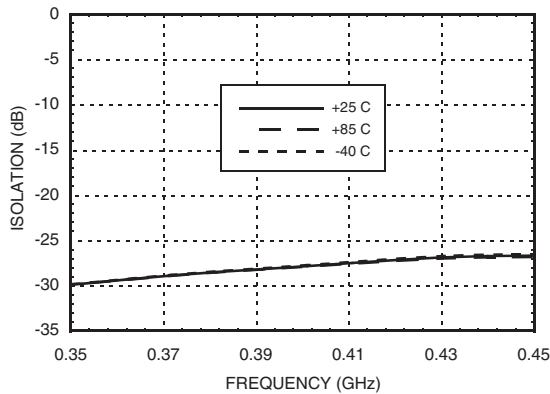

Gain, Power & IP3 vs. Supply Voltage @ 400 MHz

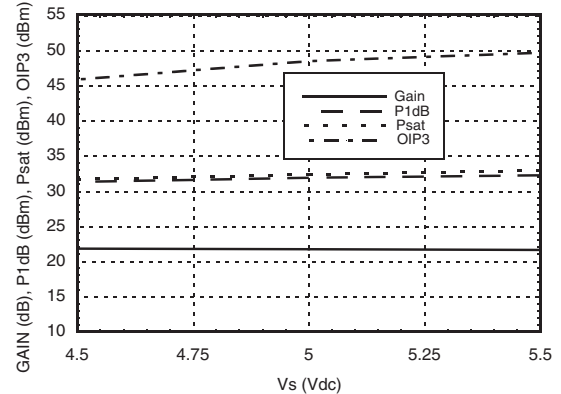

Power Compression @ 400 MHz

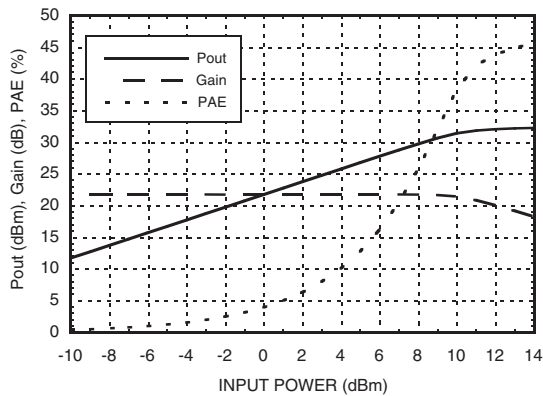

ACPR vs. Supply Voltage @ 400 MHz W-CDMA, 64 DPCH

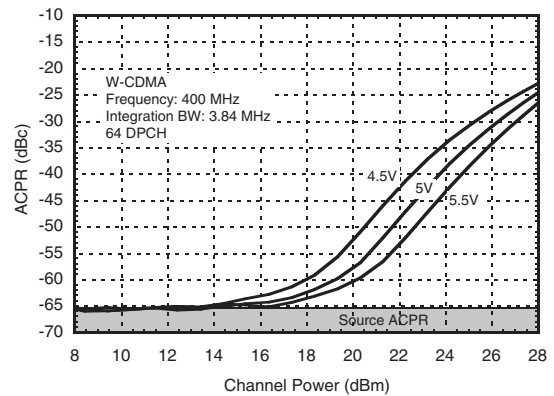

11

LINEAR & POWER AMPLIFIERS - SMT



MICROWAVE CORPORATION v01.0205



HMC453QS16G / 453QS16GE

InGaP HBT 1.6 WATT POWER AMPLIFIER, 0.4 - 2.2 GHz

Broadband Gain & Return Loss @ 470 MHz

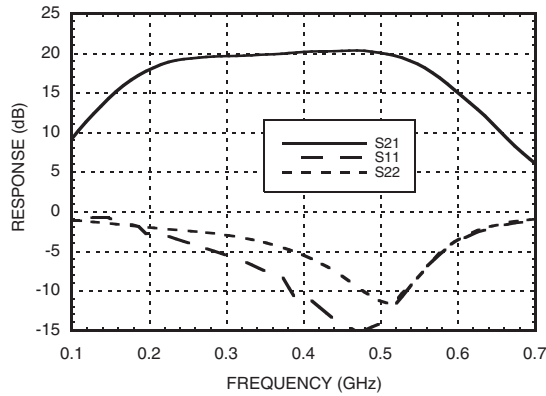

Gain vs. Temperature @ 470 MHz

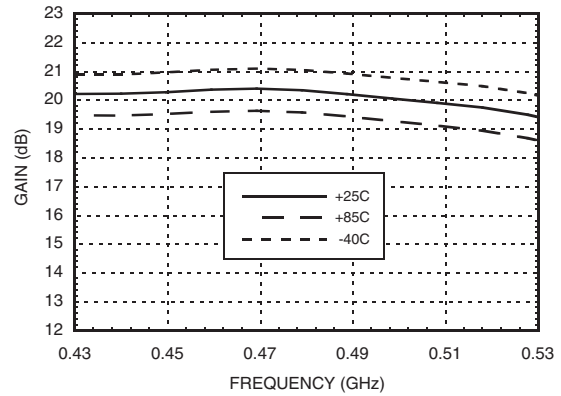

Input Return Loss vs. Temperature @ 40 MHz

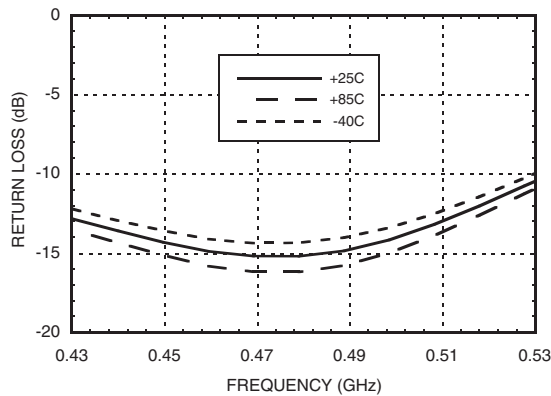

Output Return Loss vs. Temperature @ 470 MHz

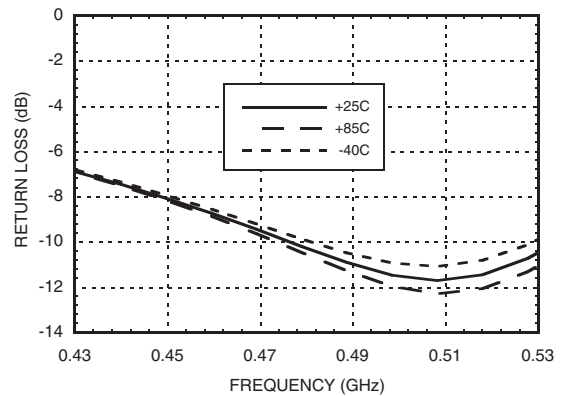

P1dB vs. Temperature @ 470 MHz

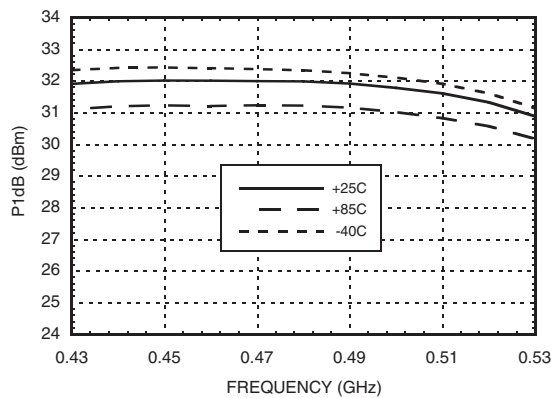

Psat vs. Temperature @ 470 MHz

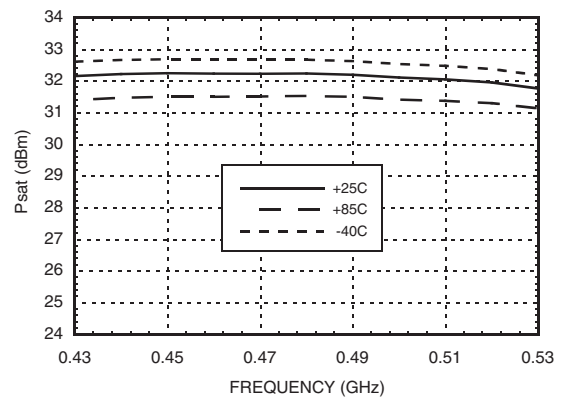

11

LINEAR & POWER AMPLIFIERS - SMT



MICROWAVE CORPORATION v01.0205



HMC453QS16G / 453QS16GE

InGaP HBT 1.6 WATT POWER AMPLIFIER, 0.4 - 2.2 GHz

Output IP3 vs. Temperature @ 470 MHz

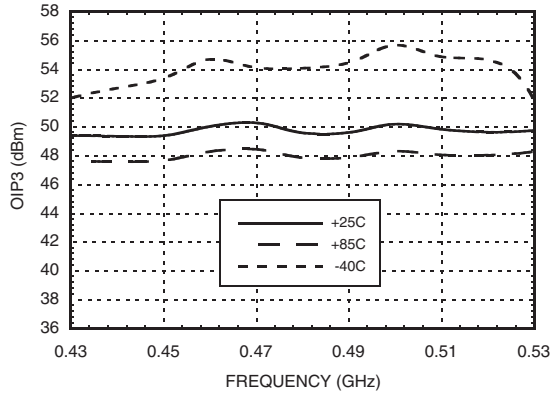

Noise Figure vs. Temperature @ 470 MHz

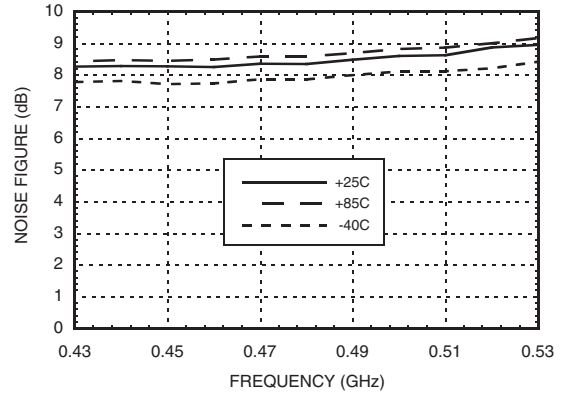

Reverse Isolation vs. Temperature @ 470 MHz

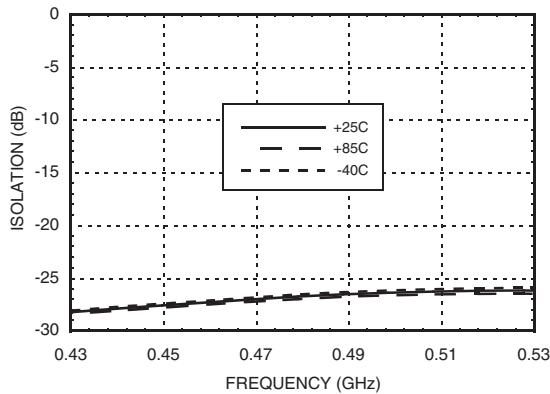

Gain, Power & IP3 vs. Supply Voltage @ 470 MHz

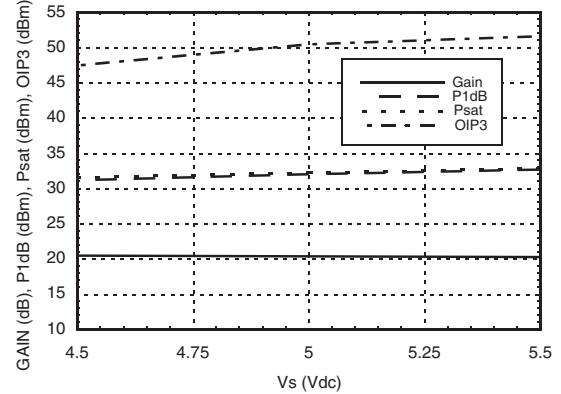

Power Compression @ 470 MHz

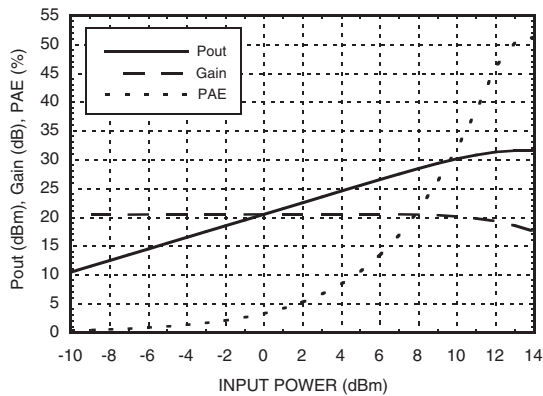

ACPR vs. Supply Voltage @ 470 MHz W-CDMA, 64 DPCH

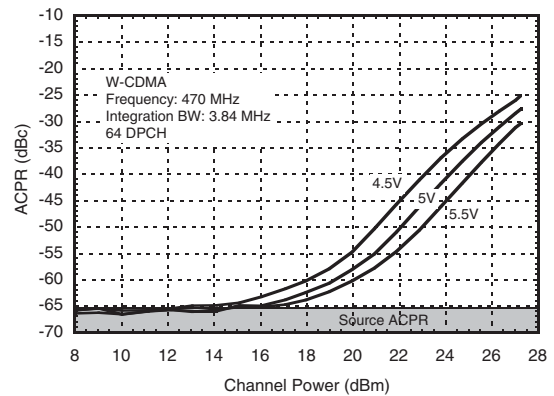

For price, delivery, and to place orders, please contact Hittite Microwave Corporation:
20 Alpha Road, Chelmsford, MA 01824 Phone: 978-250-3343 Fax: 978-250-3373
Order On-line at www.hittite.com

Broadband Gain & Return Loss @ 900 MHz

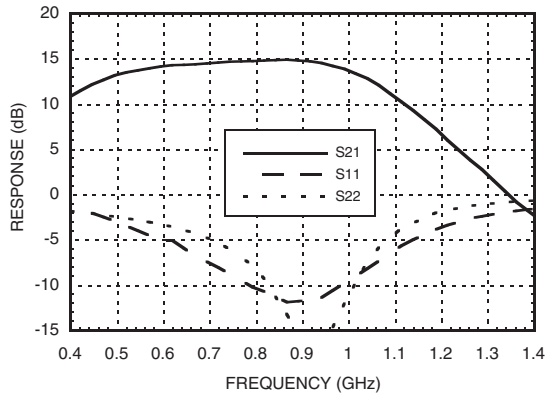

Gain vs. Temperature @ 900 MHz

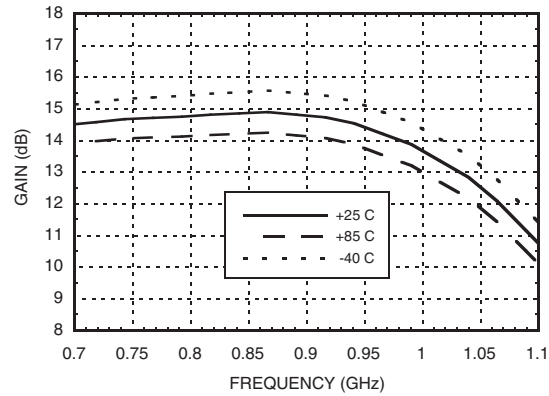

Input Return Loss vs. Temperature @ 900 MHz

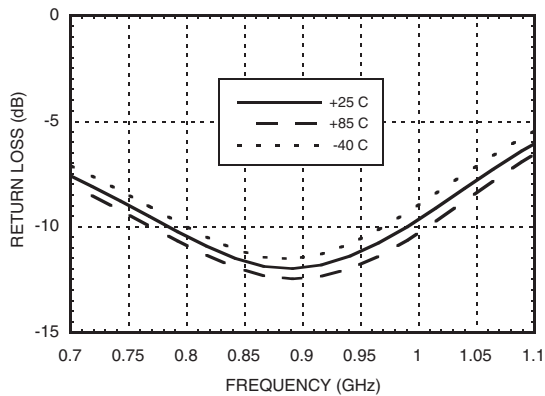

Output Return Loss vs. Temperature @ 900 MHz

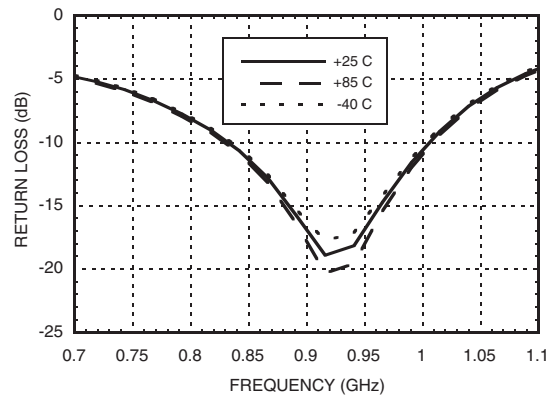

P1dB vs. Temperature @ 900 MHz

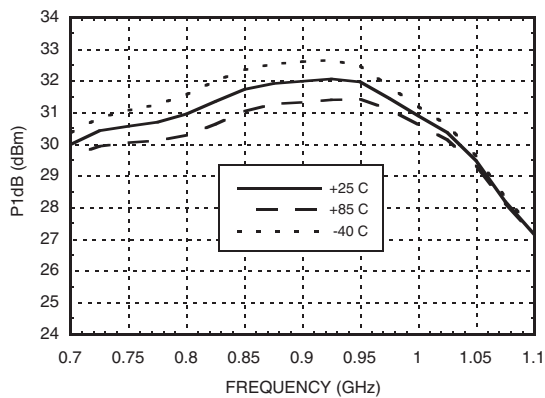

Psat vs. Temperature @ 900 MHz

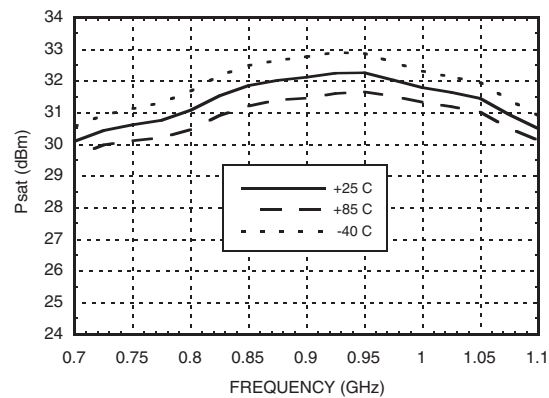



HMC453QS16G / 453QS16GE

InGaP HBT 1.6 WATT POWER AMPLIFIER, 0.4 - 2.2 GHz

Output IP3 vs. Temperature @ 900 MHz

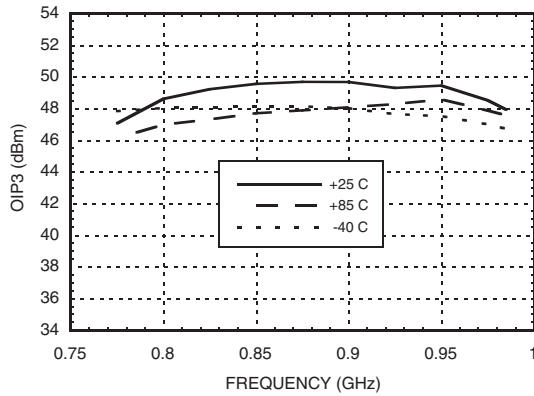

Noise Figure vs. Temperature @ 900 MHz

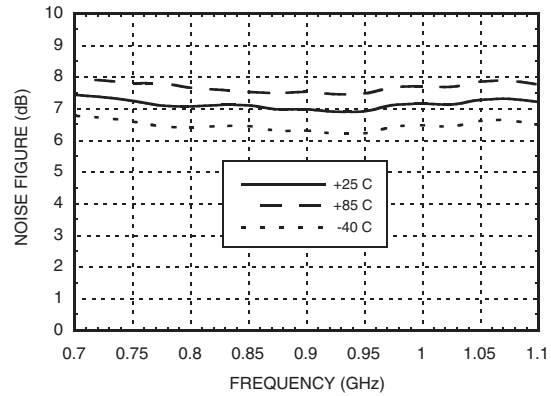

Reverse Isolation vs. Temperature @ 900 MHz

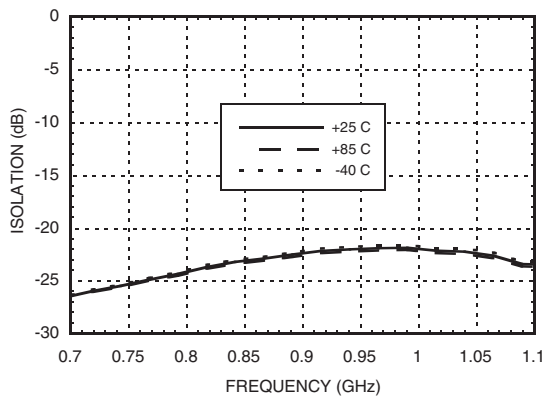

Gain, Power & IP3 vs. Supply Voltage @ 900 MHz

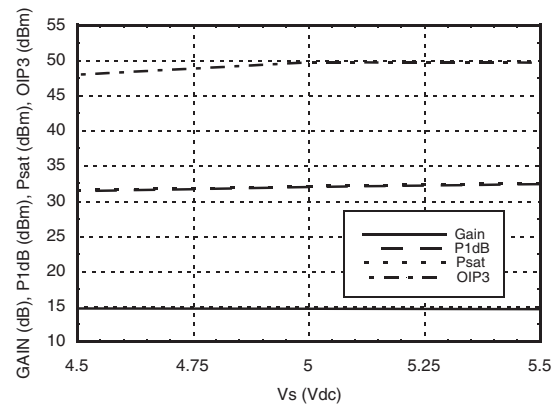

Gain, Power & IP3 vs. Supply Current @ 900 MHz*

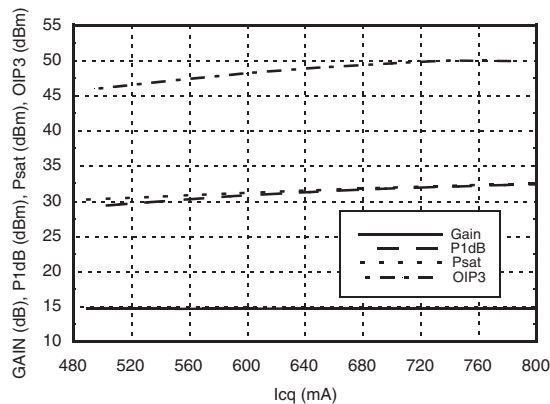

ACPR vs. Supply Voltage @ 910 MHz CDMA IS95, 9 Channels Forward

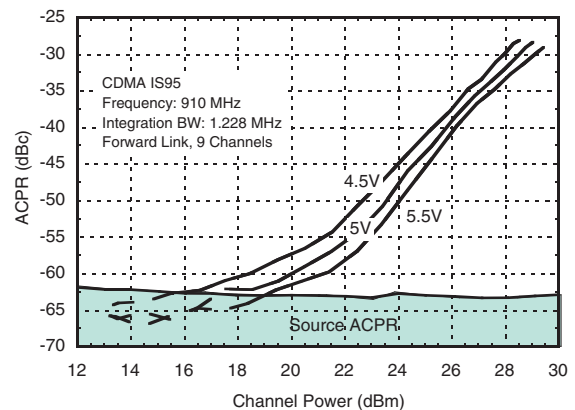

* Icq is controlled by varying VPD.



Broadband Gain & Return Loss @ 1900 MHz

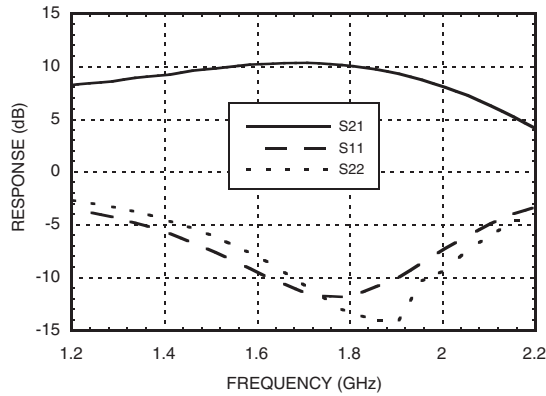

Gain vs. Temperature @ 1900 MHz

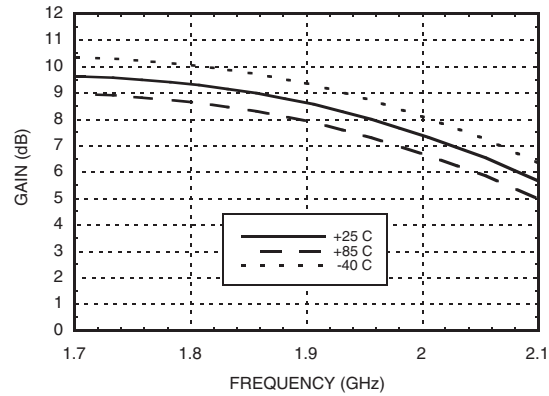

Input Return Loss vs. Temperature @ 1900 MHz

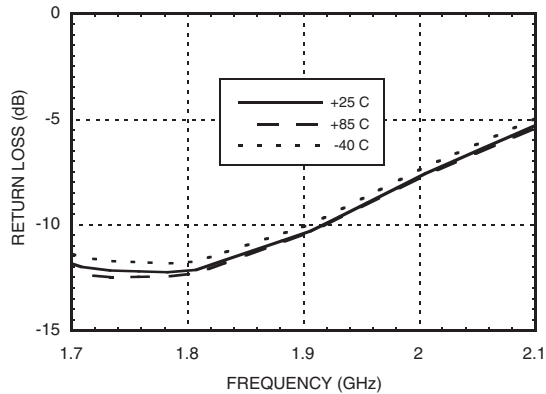

Output Return Loss vs. Temperature @ 1900 MHz

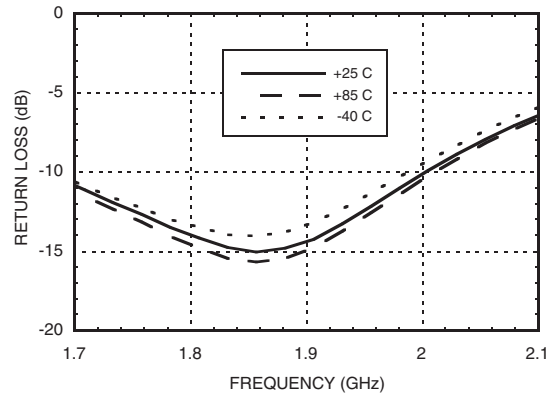

P1dB vs. Temperature @ 1900 MHz

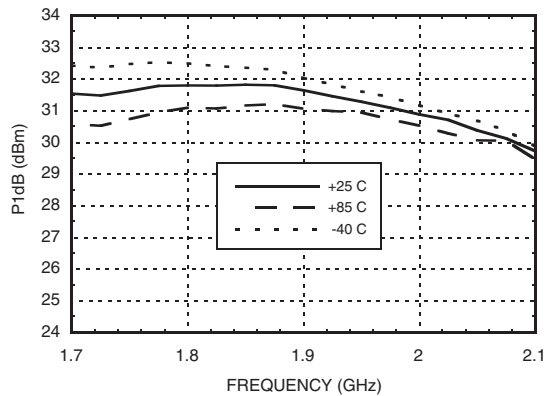

Psat vs. Temperature @ 1900 MHz

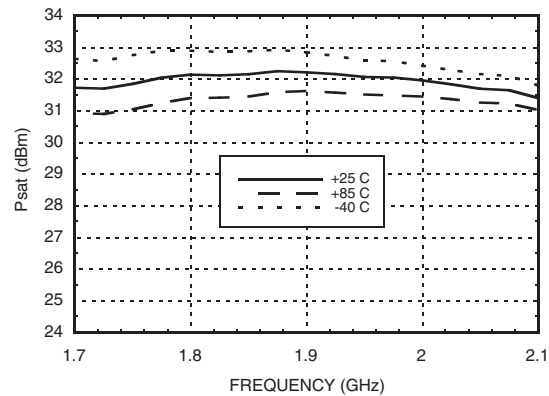



InGaP HBT 1.6 WATT POWER AMPLIFIER, 0.4 - 2.2 GHz

Output IP3 vs. Temperature @ 1900 MHz

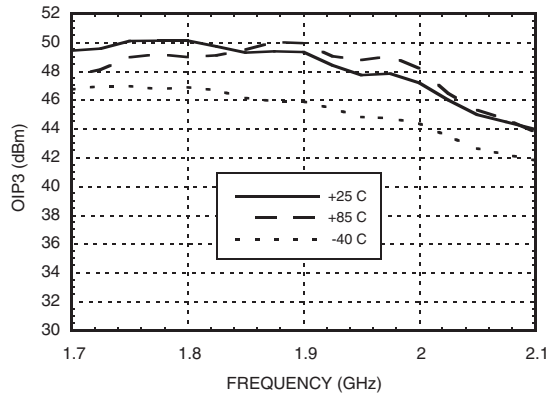

Noise Figure vs. Temperature @ 1900 MHz

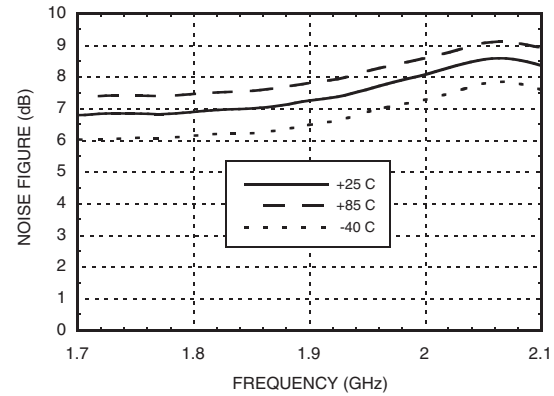

Reverse Isolation vs. Temperature @ 1900 MHz

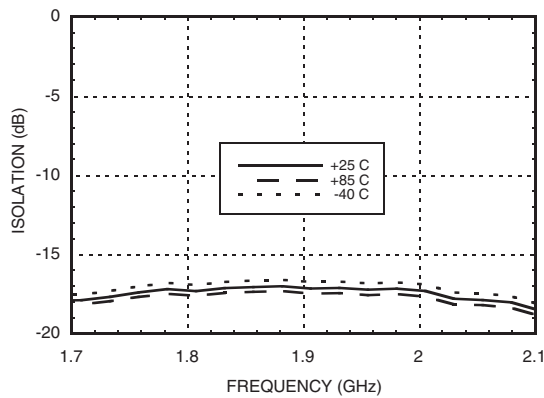

Gain, Power & IP3 vs. Supply Voltage @ 1900 MHz

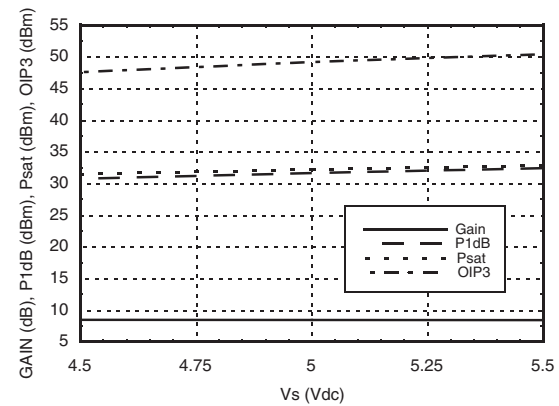

Gain, Power & IP3 vs. Supply Current @ 1900 MHz*

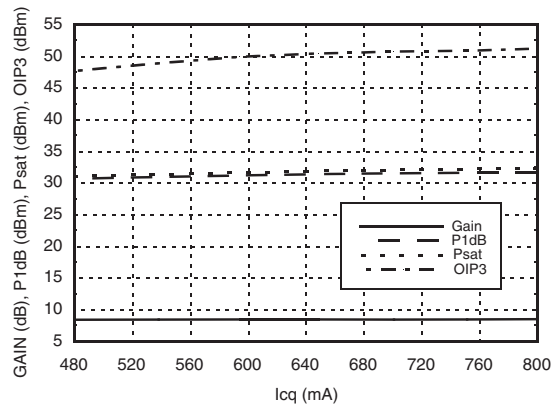

ACPR vs. Supply Voltage @ 1960 MHz CDMA 2000, 9 Channels Forward

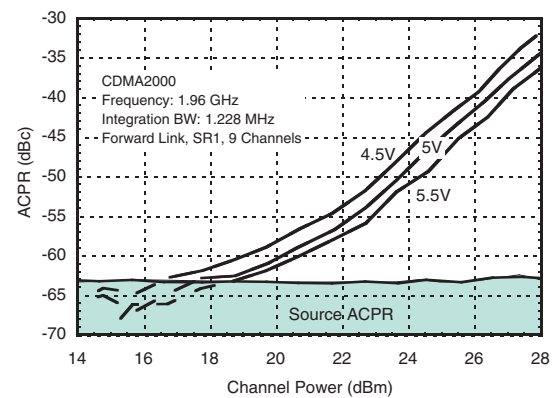

* Icq is controlled by varying VPD.



Broadband Gain & Return Loss @ 2100 MHz

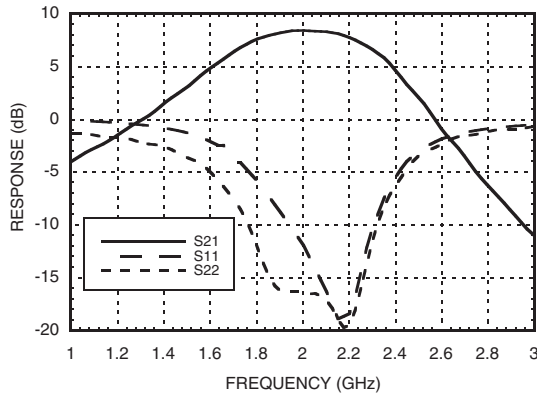

Gain vs. Temperature @ 2100 MHz

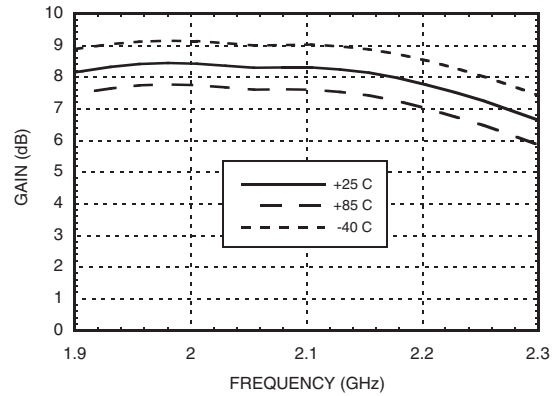

Input Return Loss vs. Temperature @ 2100 MHz

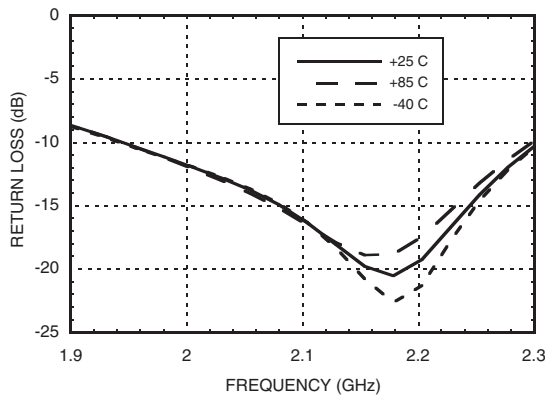

Output Return Loss vs. Temperature @ 2100 MHz

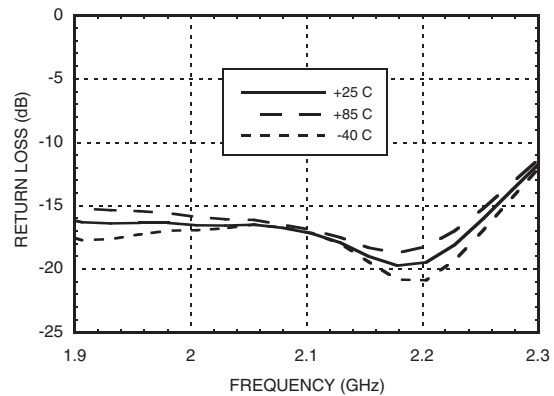

P1dB vs. Temperature @ 2100 MHz

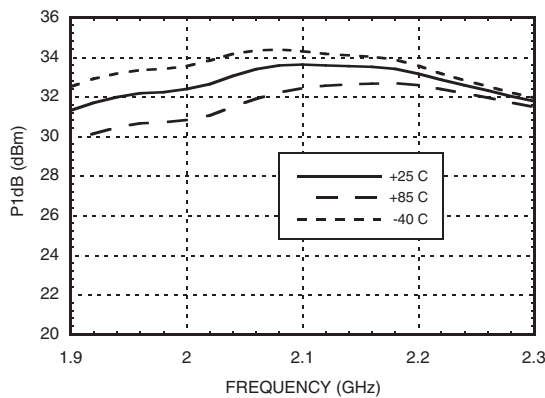

Psat vs. Temperature @ 2100 MHz

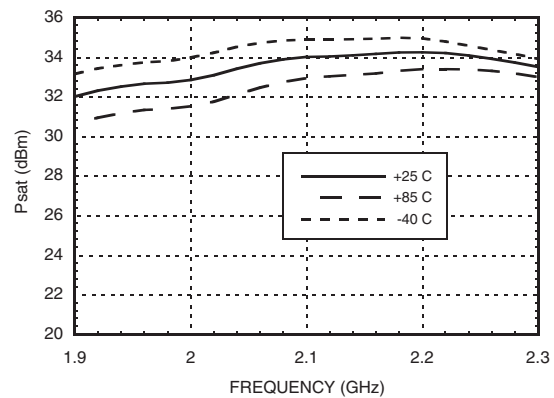

11

LINEAR & POWER AMPLIFIERS - SMT

Output IP3 vs. Temperature @ 2100 MHz

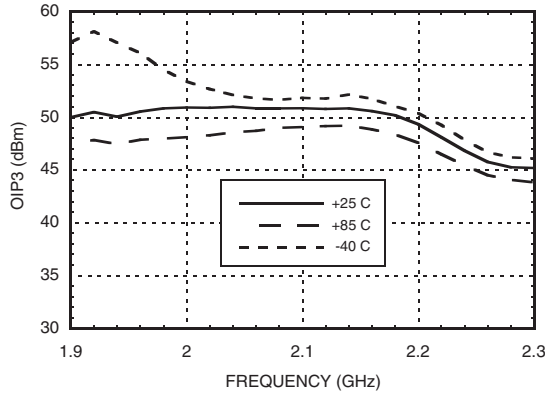

Noise Figure vs. Temperature @ 2100 MHz

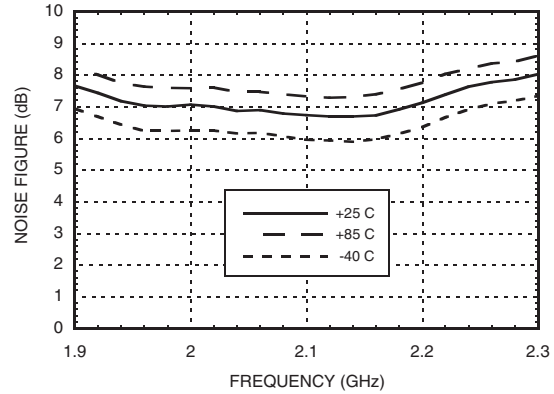

Reverse Isolation vs. Temperature @ 2100 MHz

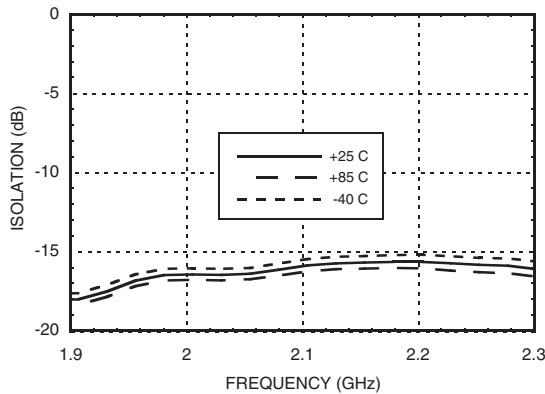

Gain, Power & IP3 vs. Supply Voltage @ 2100 MHz

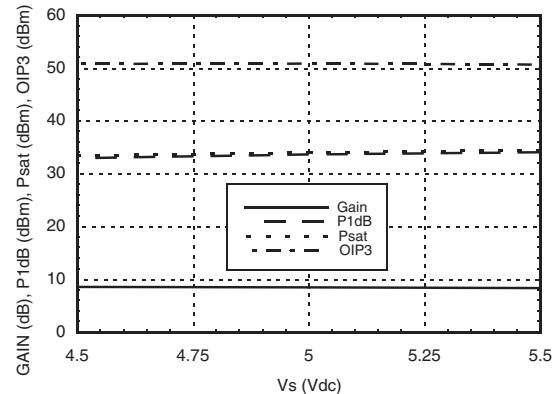

Power Compression @ 2100 MHz

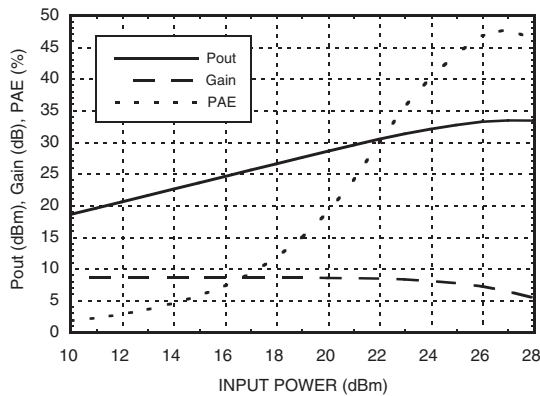

ACPR vs. Supply Voltage @ 2140 MHz W-CDMA, 64 DPCH

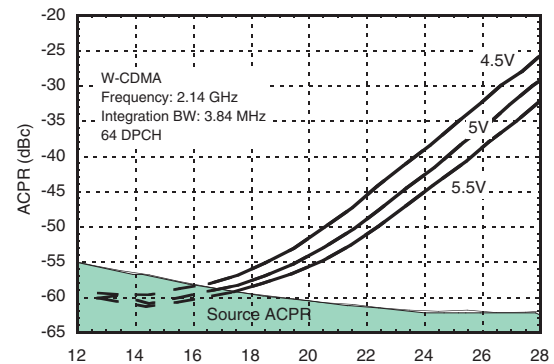

Power Dissipation

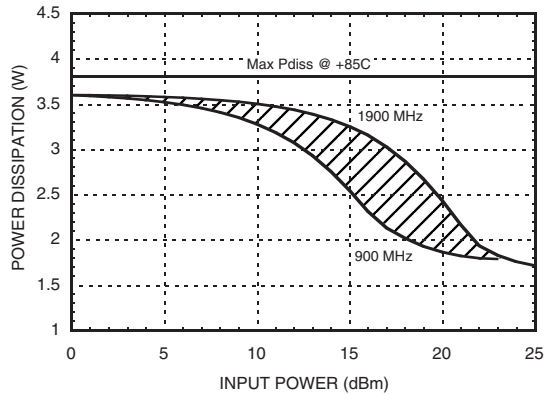

Absolute Maximum Ratings

Collector Bias Voltage (Vcc)	+6.0 Vdc
Control Voltage (Vpd)	+5.4 Vdc
RF Input Power (RFIN)(Vs = Vpd = +5Vdc)	+32 dBm
Junction Temperature	150 °C
Continuous Pdiss (T = 85 °C) (derate 58.5 mW/°C above 85 °C)	3.8 W
Thermal Resistance (junction to ground paddle)	17.1 °C/W
Storage Temperature	-65 to +150 °C
Operating Temperature	-40 to +85 °C



ELECTROSTATIC SENSITIVE DEVICE
OBSERVE HANDLING PRECAUTIONS

Outline Drawing

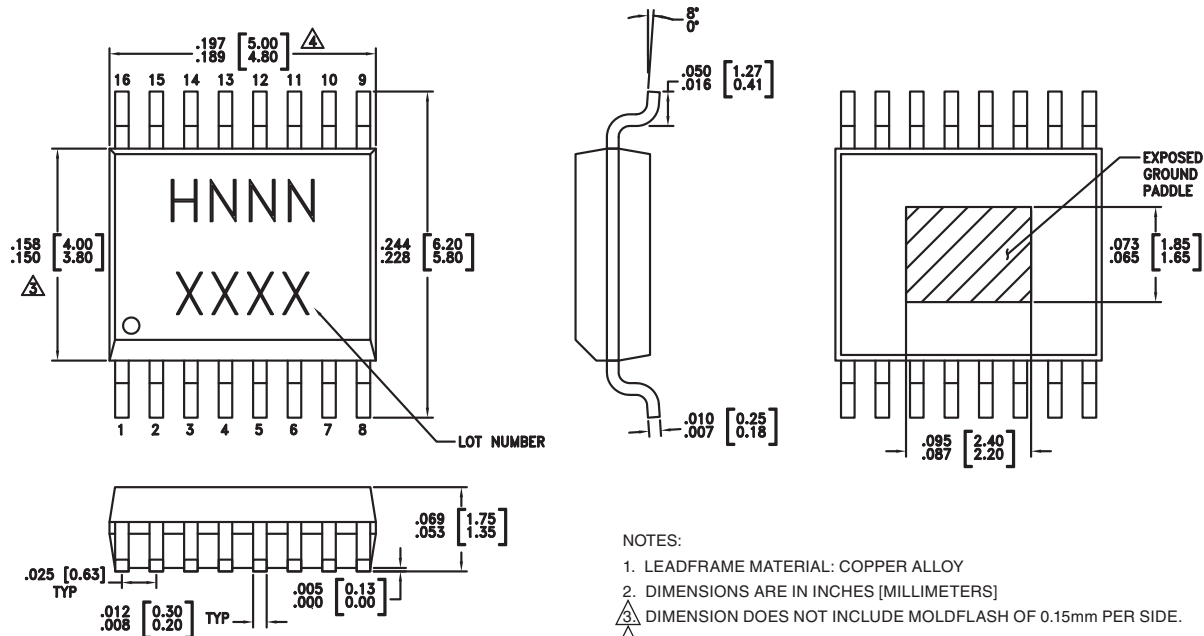

Package Information

Part Number	Package Body Material	Lead Finish	MSL Rating	Package Marking ^[3]
HMC453QS16G	Low Stress Injection Molded Plastic	Sn/Pb Solder	MSL1 ^[1]	H453 XXXX
HMC453QS16GE	RoHS-compliant Low Stress Injection Molded Plastic	100% matte Sn	MSL1 ^[2]	H453 XXXX

[1] Max peak reflow temperature of 235 °C

[2] Max peak reflow temperature of 260 °C

[3] 4-Digit lot number XXXX

Pin Descriptions

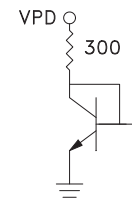
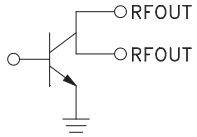
Pin Number	Function	Description	Interface Schematic
1, 2, 4, 5, 7-10, 13-16	GND	These pins & package bottom must be connected to RF/DC ground.	
3	VPD	Power control pin. For maximum power, this pin should be connected to 5V. A higher voltage is not recommended. For lower idle current, this voltage can be reduced.	
6	RFIN	This pin is DC coupled. Off chip matching components are required. See Application Circuit herein.	
11, 12	RFOUT	RF output and DC Bias input for the output amplifier stage. Off chip matching components are required. See Application Circuit herein.	

400 MHz Application Circuit

This circuit was used to specify the performance for 400-410 MHz operation. Contact the HMC Applications Group for assistance in optimizing performance for your application.

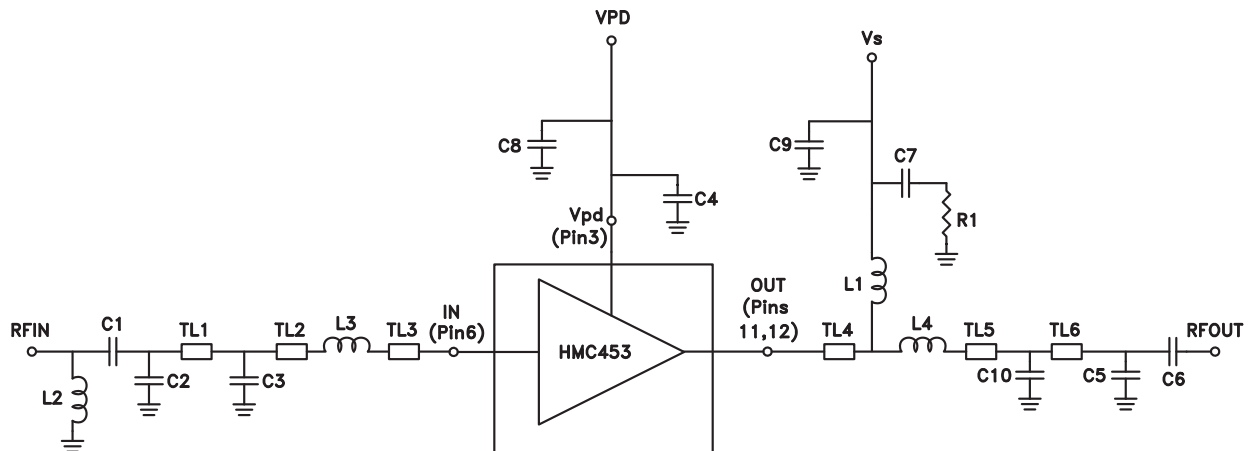

Recommended Component Values	
C1, C5	12 pF
C2, C10	8.2 pF
C3	6.8 pF
C4, C7	100 pF
C6	39 pF
C8, C9	2.2 μF
L1	47 nH
L2	40 nH
L3, L4	4.3 nH
R1	5.1 Ohm

	TL1	TL2	TL3	TL4	TL5	TL6
Impedance	50 Ohm	50 Ohm	50 Ohm	50 Ohm	50 Ohm	50 Ohm
Physical Length	0.22"	0.04"	0.04"	0.16"	0.04"	0.05"
Electrical Length	5°	1°	1°	4°	1°	1°
PCB Material: 10 mil Rogers 4350, Er = 3.48						

For price, delivery, and to place orders, please contact Hittite Microwave Corporation:
 20 Alpha Road, Chelmsford, MA 01824 Phone: 978-250-3343 Fax: 978-250-3373
 Order On-line at www.hittite.com

400 MHz Evaluation PCB

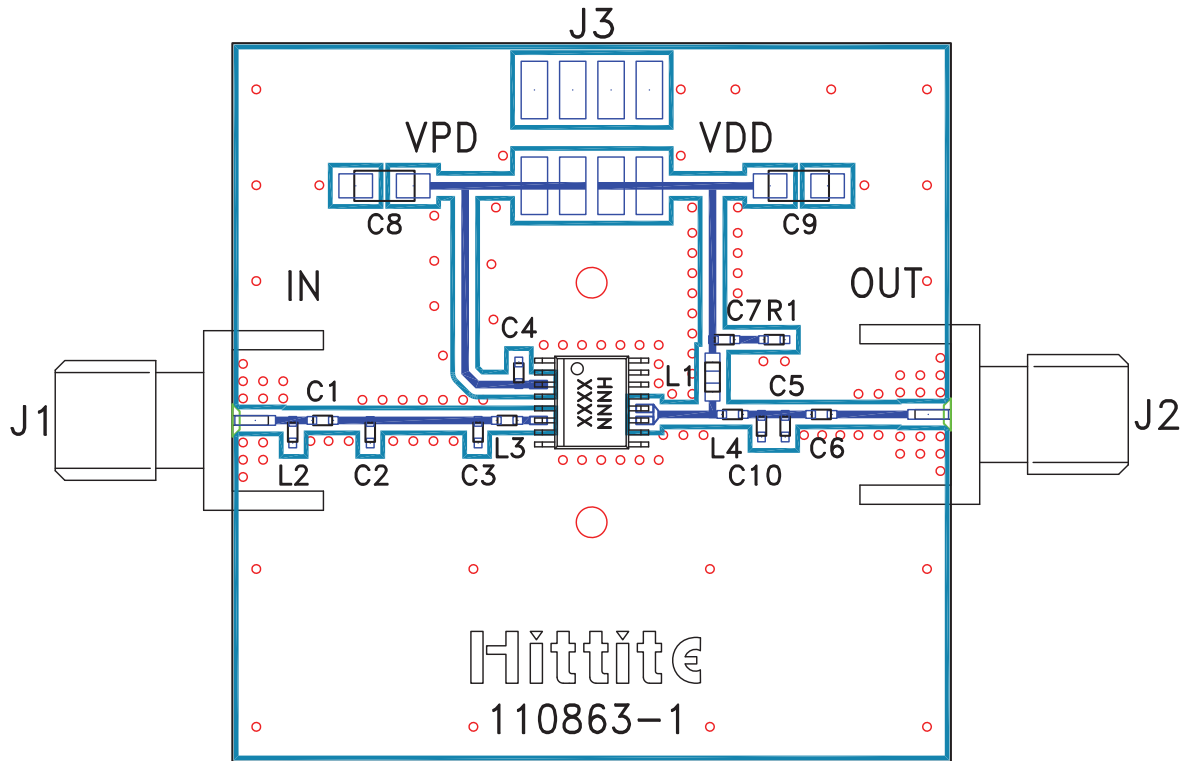

List of Materials for Evaluation PCB 110865-400 ^[1]

Item	Description
J1 - J2	PCB Mount SMA Connector
J3	2 mm DC Header
C1, C5	12 pF Capacitor, 0402 Pkg.
C2, C10	8.2 pF Capacitor, 0402 Pkg.
C3	6.8 pF Capacitor, 0402 Pkg.
C4, C7	100 pF Capacitor, 0402 Pkg.
C6	39 pF Capacitor, 0402 Pkg.
C8, C9	2.2 μ F Capacitor, Tantalum
L1	47 nH Inductor, 0603 Pkg.
L2	40 nH Inductor, 0402 Pkg.
L3, L4	4.3 nH Inductor, 0402 Pkg.
R1	5.1 Ohm Resistor, 0402 Pkg.
U1	HMC453QS16G / HMC453QS16GE Linear Amp
PCB [2]	110863 Evaluation PCB, 10 mils

[1] Reference this number when ordering complete evaluation PCB

[2] Circuit Board Material: Rogers 4350, Er = 3.48

The circuit board used in this application should use RF circuit design techniques. Signal lines should have 50 ohm impedance while the package ground leads and exposed paddle should be connected directly to the ground plane similar to that shown. A sufficient number of VIA holes should be used to connect the top and bottom ground planes. The evaluation board should be mounted to an appropriate heat sink. The evaluation circuit board shown is available from Hittite upon request.



470 MHz Application Circuit

This circuit was used to specify the performance for 450-496 MHz operation. Contact the HMC Applications Group for assistance in optimizing performance for your application.

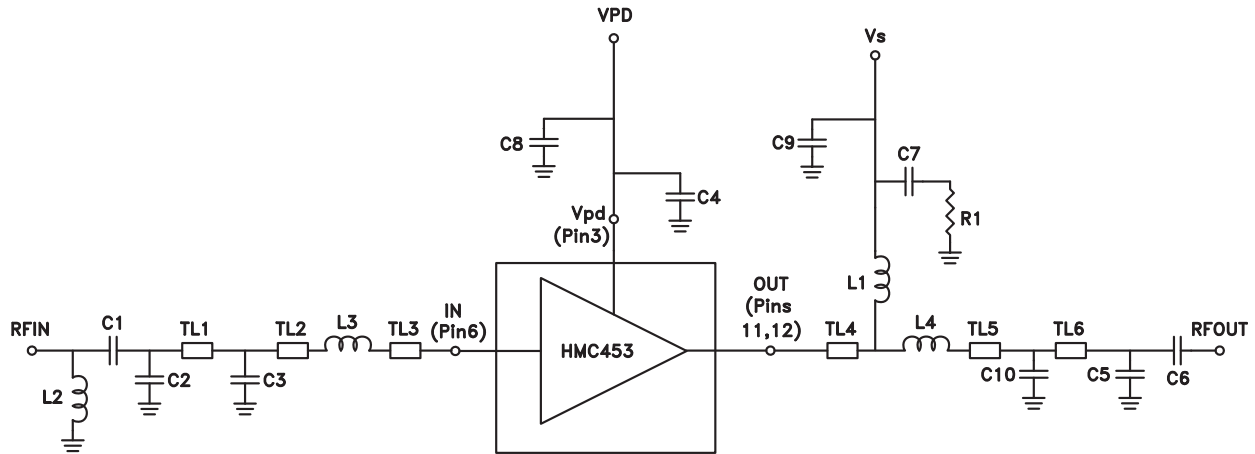

Recommended Component Values	
C1	12 pF
C2	8.2 pF
C3	6.8 pF
C4, C7	100 pF
C5	10 pF
C6	39 pF
C8, C9	2.2 μF
C10	5.6 pF
L1	47 nH
L2	40 nH
L3, L4	4.3 nH
R1	5.1 Ohm

	TL1	TL2	TL3	TL4	TL5	TL6
Impedance	50 Ohm	50 Ohm	50 Ohm	50 Ohm	50 Ohm	50 Ohm
Physical Length	0.22"	0.04"	0.04"	0.16"	0.04"	0.05"
Electrical Length	6°	1°	1°	4°	1°	1°
PCB Material: 10 mil Rogers 4350, Er = 3.48						

470 MHz Evaluation PCB

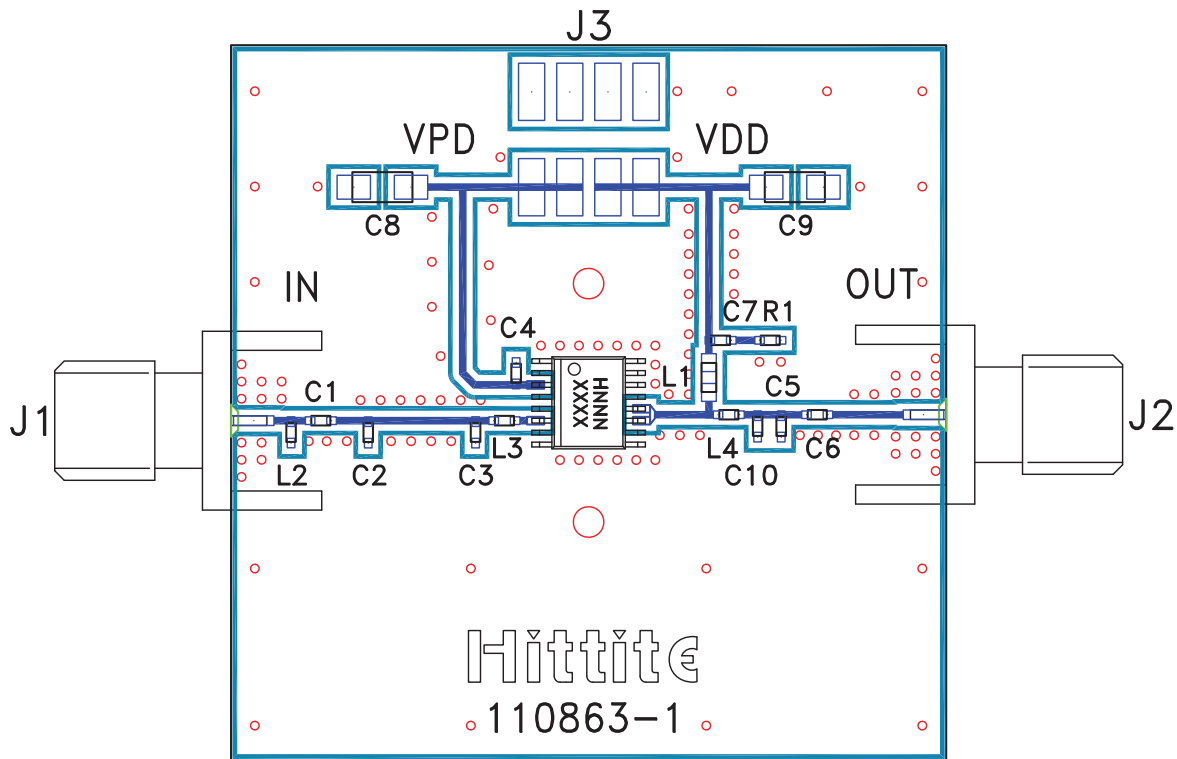

List of Materials for Evaluation PCB 110976-470 [1]

Item	Description
J1 - J2	PCB Mount SMA Connector
J3	2 mm DC Header
C1	12 pF Capacitor, 0402 Pkg.
C2	8.2 pF Capacitor, 0402 Pkg.
C3	6.8 pF Capacitor, 0402 Pkg.
C4, C7	100 pF Capacitor, 0402 Pkg.
C5	10 pF Capacitor, 0402 Pkg.
C6	39 pF Capacitor, 0402 Pkg.
C8, C9	2.2 μ F Capacitor, Tantalum
C10	5.6 pF Capacitor, 0402 Pkg.
L1	47 nH Inductor, 0603 Pkg.
L2	40 nH Inductor, 0402 Pkg.
L3, L4	4.3 nH Inductor, 0402 Pkg.
R1	5.1 Ohm Resistor, 0402 Pkg.
U1	HMC453QS16G / HMC453QS16GE Linear Amp
PCB [2]	110863 Evaluation PCB, 10 mils

[1] Reference this number when ordering complete evaluation PCB

[2] Circuit Board Material: Rogers 4350, Er = 3.48

The circuit board used in this application should use RF circuit design techniques. Signal lines should have 50 ohm impedance while the package ground leads and exposed paddle should be connected directly to the ground plane similar to that shown. A sufficient number of via holes should be used to connect the top and bottom ground planes. The evaluation board should be mounted to an appropriate heat sink. The evaluation circuit board shown is available from Hittite upon request.

900 MHz Application Circuit

This circuit was used to specify the performance for 810-960 MHz operation. Contact the HMC Applications Group for assistance in optimizing performance for your application.

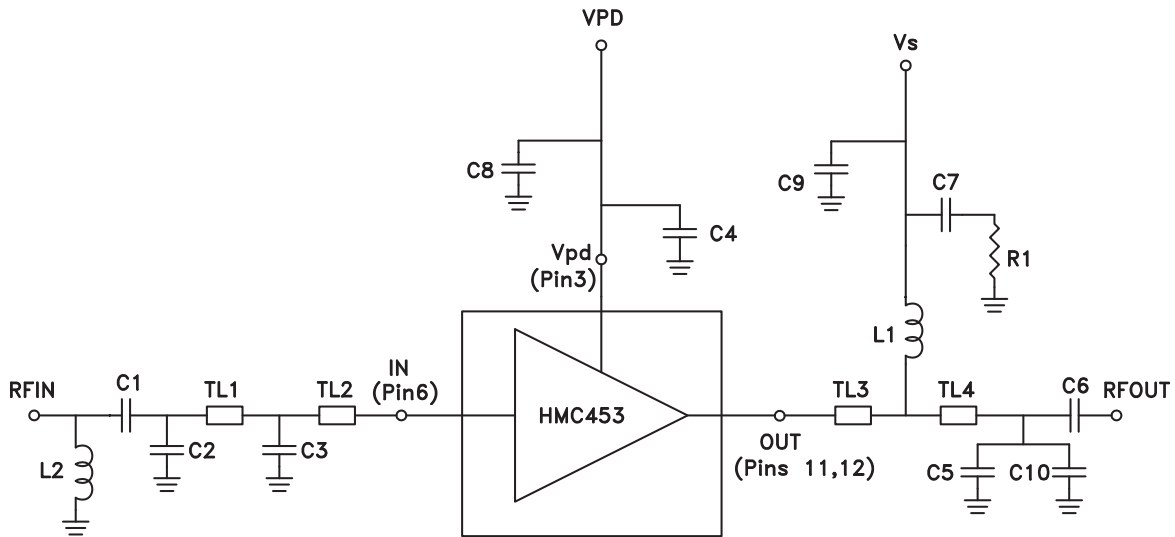

	TL1	TL2	TL3	TL4
Impedance	50 Ohm	50 Ohm	50 Ohm	50 Ohm
Physical Length	0.26"	0.08"	0.12"	0.15"
Electrical Length	14°	4°	6°	8°
PCB Material: 10 mil Rogers 4350, Er = 3.48				

Recommended Component Values	
C1	5 pF
C2, C3	3.3 pF
C4, C7	100 pF
C5	8.2 pF
C6	56 pF
C8, C9	2.2 μF
C10	1 pF
L1	30 nH
L2	20 nH
R1	5.6 Ohm

900 MHz Evaluation PCB

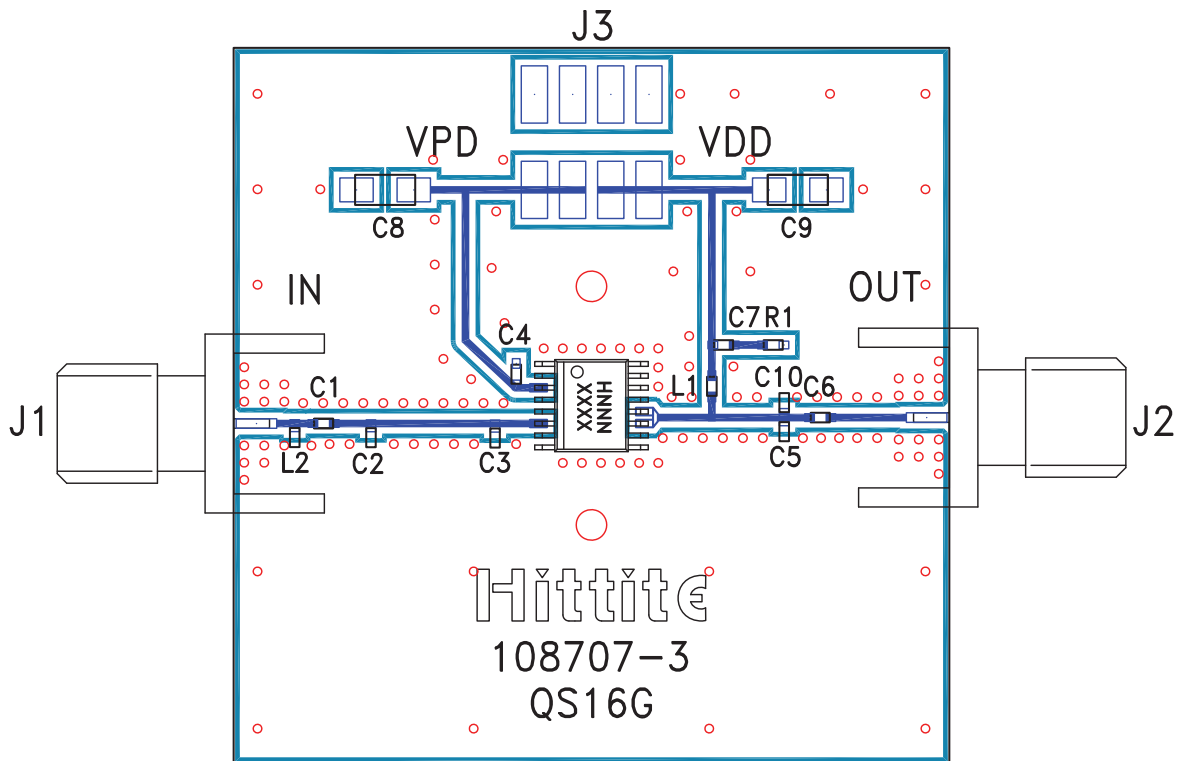

List of Materials for Evaluation PCB 108709-900 [1]

Item	Description
J1 - J2	PCB Mount SMA Connector
J3	2 mm DC Header
C1	5.0 pF Capacitor, 0402 Pkg.
C2, C3	3.3 pF Capacitor, 0402 Pkg.
C4, C7	100 pF Capacitor, 0402 Pkg.
C5	8.2 pF Capacitor, 0402 Pkg.
C6	56 pF Capacitor, 0402 Pkg.
C8, C9	2.2 μ F Capacitor, Tantalum
C10	1.0 pF Capacitor, 0402 Pkg.
L1	30 nH Inductor, 0402 Pkg.
L2	20 nH Inductor, 0402 Pkg.
R1	5.6 Ohm Resistor, 0402 Pkg.
U1	HMC453QS16G / HMC453QS16GE Linear Amp
PCB [2]	108707 Evaluation PCB, 10 mils

[1] Reference this number when ordering complete evaluation PCB

[2] Circuit Board Material: Rogers 4350, Er = 3.48

The circuit board used in this application should use RF circuit design techniques. Signal lines should have 50 ohm impedance while the package ground leads and exposed paddle should be connected directly to the ground plane similar to that shown. A sufficient number of via holes should be used to connect the top and bottom ground planes. The evaluation board should be mounted to an appropriate heat sink. The evaluation circuit board shown is available from Hittite upon request.



1900 MHz Application Circuit

This circuit was used to specify the performance for 1710-1990 MHz operation. Contact the HMC Applications Group for assistance in optimizing performance for your application.

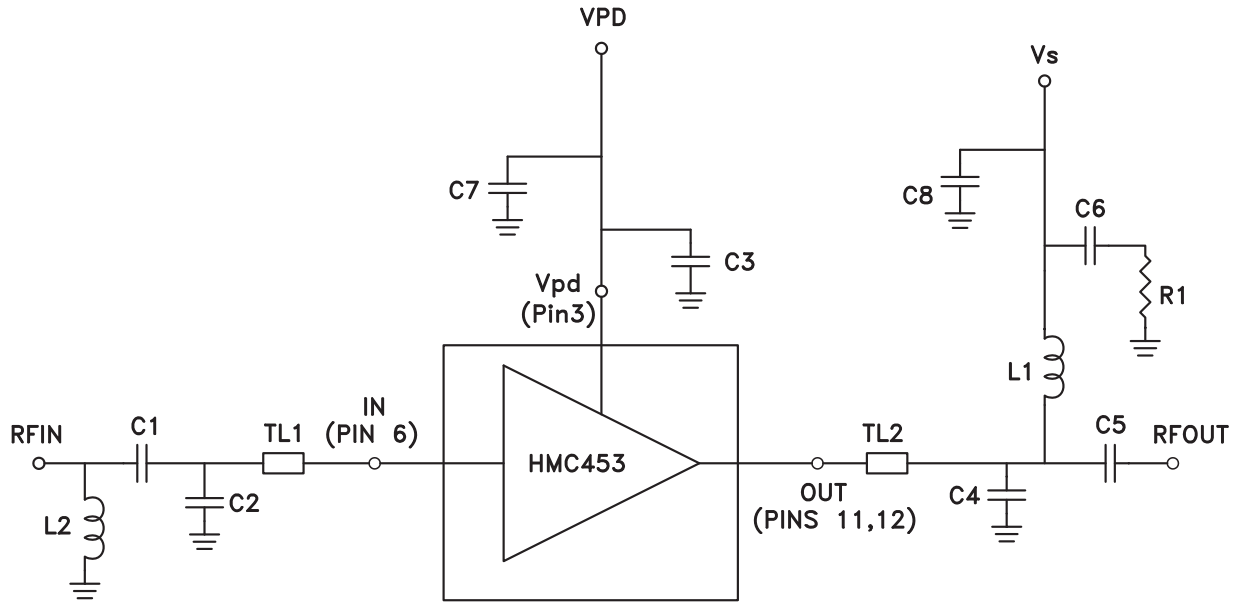

	TL1	TL2
Impedance	50 Ohm	50 Ohm
Physical Length	0.04"	0.04"
Electrical Length	4°	4°
PCB Material: 10 mil Rogers 4350, Er = 3.48		

Recommended Component Values	
C1	0.8 pF
C2	1.2 pF
C3, C6	100 pF
C4	4.7 pF
C5	15 pF
C7, C8	2.2 μF
L1	18 nH
L2	20 nH
R1	5.6 Ohms

1900 MHz Evaluation PCB

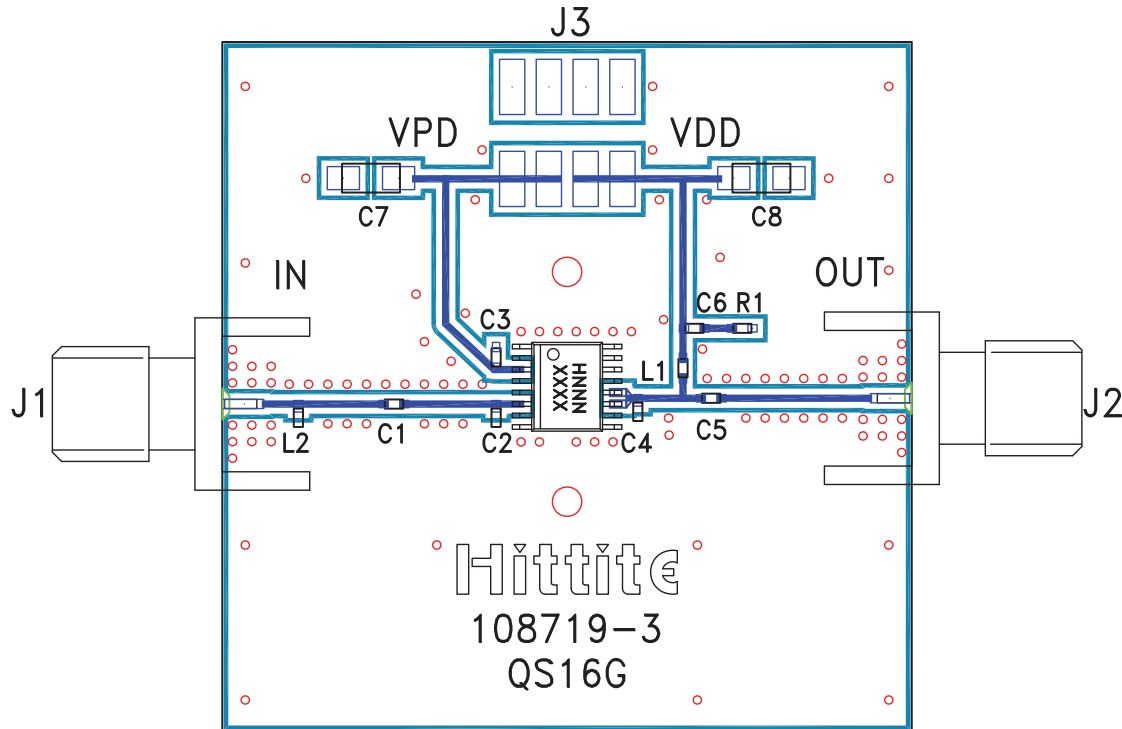

List of Materials for Evaluation PCB 108721-1900 [1]

Item	Description
J1 - J2	PCB Mount SMA Connector
J3	2 mm DC Header
C1	0.8 pF Capacitor, 0402 Pkg.
C2	1.2 pF Capacitor, 0402 Pkg.
C3, C6	100 pF Capacitor, 0402 Pkg.
C4	4.7 pF Capacitor, 0402 Pkg.
C5	15 pF Capacitor, 0402 Pkg.
C7, C8	2.2 μ F Capacitor, Tantalum
L1	18 nH Inductor, 0402 Pkg.
L2	20 nH Inductor, 0402 Pkg.
R1	5.6 Ohm Resistor, 0402 Pkg.
U1	HMC453QS16G / HMC453QS16GE Linear Amp
PCB [2]	108719 Evaluation PCB, 10 mils

[1] Reference this number when ordering complete evaluation PCB

[2] Circuit Board Material: Rogers 4350, Er = 3.48

The circuit board used in this application should use RF circuit design techniques. Signal lines should have 50 ohm impedance while the package ground leads and exposed paddle should be connected directly to the ground plane similar to that shown. A sufficient number of via holes should be used to connect the top and bottom ground planes. The evaluation board should be mounted to an appropriate heat sink. The evaluation circuit board shown is available from Hittite upon request.

2100 MHz Application Circuit

This circuit was used to specify the performance for 2100-2170 MHz operation. Contact the HMC Applications Group for assistance in optimizing performance for your application.

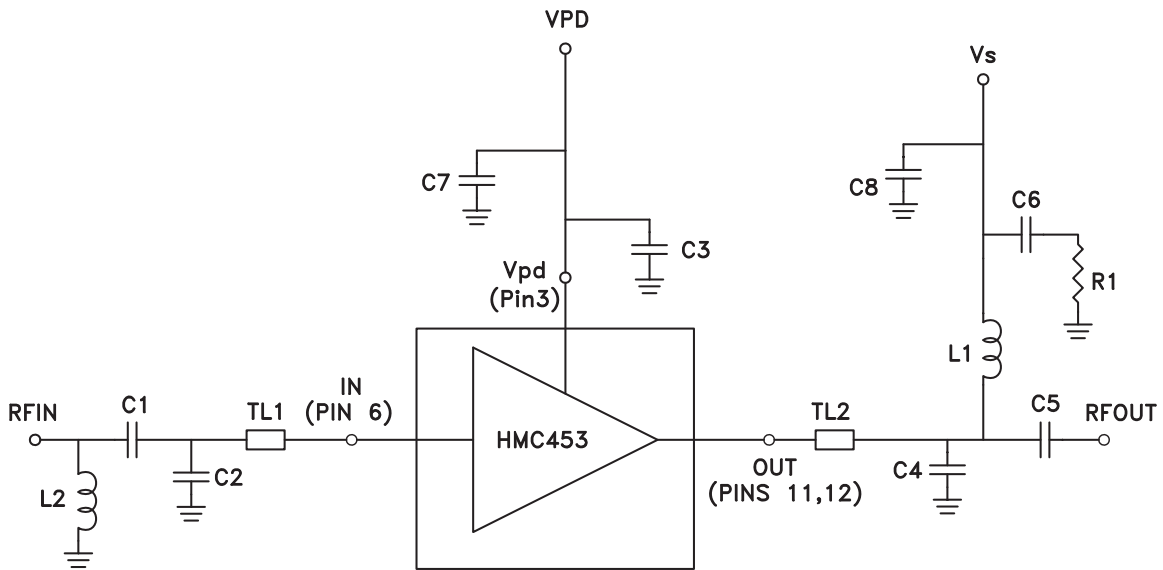

	TL1	TL2
Impedance	50 Ohm	50 Ohm
Physical Length	0.04"	0.04"
Electrical Length	5°	5°
PCB Material: 10 mil Rogers 4350, Er = 3.48		

Recommended Component Values	
C1	0.8 pF
C2	1 pF
C3, C6	100 pF
C4	3.9 pF
C5	15 pF
C7, C8	2.2 μF
L1	12 nH
L2	20 nH
R1	5.1 Ohm



2100 MHz Evaluation PCB

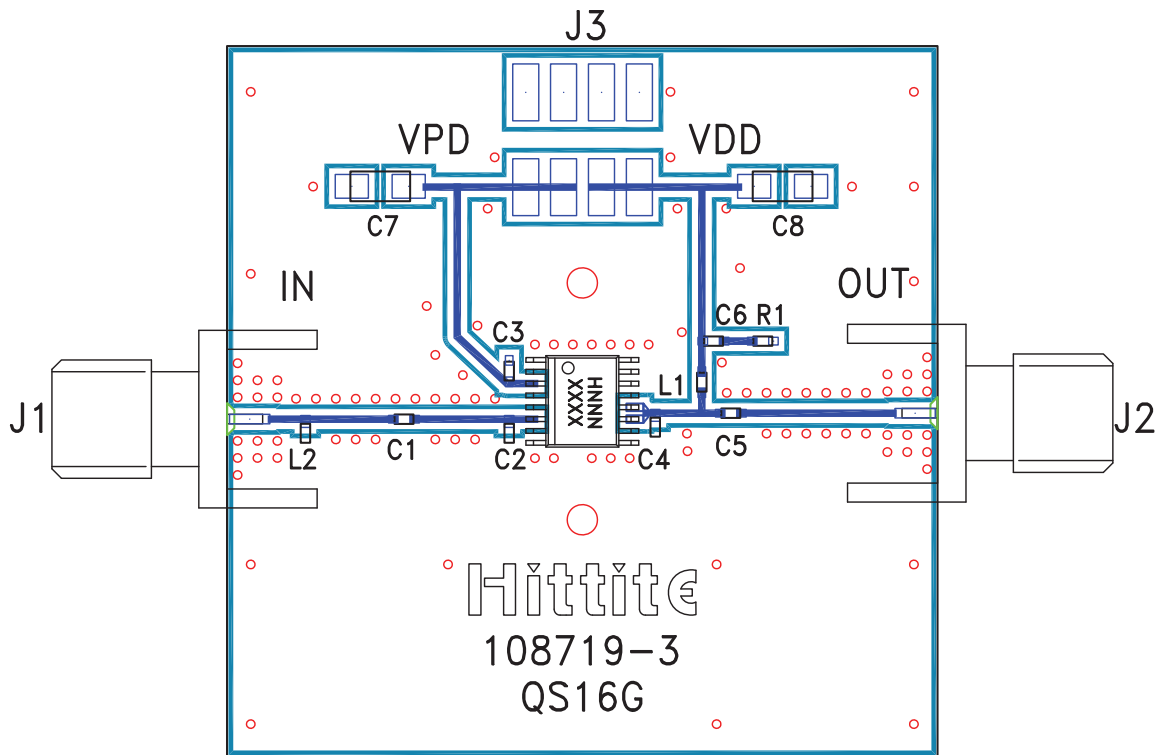

List of Materials for Evaluation PCB 10994-2100 [1]

Item	Description
J1 - J2	PCB Mount SMA Connector
J3	2 mm DC Header
C1	0.8 pF Capacitor, 0402 Pkg.
C2	1.0 pF Capacitor, 0402 Pkg.
C3, C6	100 pF Capacitor, 0402 Pkg.
C4	3.9 pF Capacitor, 0402 Pkg.
C5	15 pF Capacitor, 0402 Pkg.
C7, C8	2.2 μ F Capacitor, Tantalum
L1	12 nH Inductor, 0402 Pkg.
L2	20 nH Inductor, 0402 Pkg.
R1	5.1 Ohm Resistor, 0402 Pkg.
U1	HMC453QS16G / HMC453QS16GE Linear Amp
PCB [2]	108719 Evaluation PCB, 10 mils

[1] Reference this number when ordering complete evaluation PCB

[2] Circuit Board Material: Rogers 4350, Er = 3.48

The circuit board used in this application should use RF circuit design techniques. Signal lines should have 50 ohm impedance while the package ground leads and exposed paddle should be connected directly to the ground plane similar to that shown. A sufficient number of via holes should be used to connect the top and bottom ground planes. The evaluation board should be mounted to an appropriate heat sink. The evaluation circuit board shown is available from Hittite upon request.

Компания «Океан Электроники» предлагает заключение долгосрочных отношений при поставках импортных электронных компонентов на взаимовыгодных условиях!

Наши преимущества:

- Поставка оригинальных импортных электронных компонентов напрямую с производств Америки, Европы и Азии, а так же с крупнейших складов мира;
- Широкая линейка поставок активных и пассивных импортных электронных компонентов (более 30 млн. наименований);
- Поставка сложных, дефицитных, либо снятых с производства позиций;
- Оперативные сроки поставки под заказ (от 5 рабочих дней);
- Экспресс доставка в любую точку России;
- Помощь Конструкторского Отдела и консультации квалифицированных инженеров;
- Техническая поддержка проекта, помощь в подборе аналогов, поставка прототипов;
- Поставка электронных компонентов под контролем ВП;
- Система менеджмента качества сертифицирована по Международному стандарту ISO 9001;
- При необходимости вся продукция военного и аэрокосмического назначения проходит испытания и сертификацию в лаборатории (по согласованию с заказчиком);
- Поставка специализированных компонентов военного и аэрокосмического уровня качества (Xilinx, Altera, Analog Devices, Intersil, Interpoint, Microsemi, Actel, Aeroflex, Peregrine, VPT, Syfer, Eurofarad, Texas Instruments, MS Kennedy, Miteq, Cobham, E2V, MA-COM, Hittite, Mini-Circuits, General Dynamics и др.);

Компания «Океан Электроники» является официальным дистрибьютором и эксклюзивным представителем в России одного из крупнейших производителей разъемов военного и аэрокосмического назначения «JONHON», а так же официальным дистрибьютором и эксклюзивным представителем в России производителя высокотехнологичных и надежных решений для передачи СВЧ сигналов «FORSTAR».



JONHON

«JONHON» (основан в 1970 г.)

Разъемы специального, военного и аэрокосмического назначения:

(Применяются в военной, авиационной, аэрокосмической, морской, железнодорожной, горно- и нефтедобывающей отраслях промышленности)

«FORSTAR» (основан в 1998 г.)

ВЧ соединители, коаксиальные кабели, кабельные сборки и микроволновые компоненты:

(Применяются в телекоммуникациях гражданского и специального назначения, в средствах связи, РЛС, а так же военной, авиационной и аэрокосмической отраслях промышленности).



Телефон: 8 (812) 309-75-97 (многоканальный)

Факс: 8 (812) 320-03-32

Электронная почта: ocean@oceanchips.ru

Web: <http://oceanchips.ru/>

Адрес: 198099, г. Санкт-Петербург, ул. Калинина, д. 2, корп. 4, лит. А