

EL5172, EL5372

250MHz Differential Line Receivers

FN7311
Rev 11.00
August 11, 2015

The EL5172 and EL5372 are single and triple high bandwidth amplifiers designed to extract the difference signal from noisy environments. They are primarily targeted for applications such as receiving signals from twisted-pair lines or any application where common mode noise injection is likely to occur.

The EL5172 and EL5372 are stable for a gain of one and requires two external resistors to set the voltage gain.

The output common mode level is set by the reference pin (V_{REF}), which has a -3dB bandwidth of over 120MHz. Generally, this pin is grounded but it can be tied to any voltage reference.

The output can deliver a maximum of ±60mA and is short circuit protected to withstand a temporary overload condition.

The EL5172 is available in the 8 Ld SOIC and 8 Ld MSOP packages and the EL5372 in a 24 Ld QSOP package. Both are specified for operation over the full -40°C to +85°C temperature range.

Pinouts

EL5172
(8 LD SOIC, MSOP)
TOP VIEW



EL5372
(24 LD QSOP)
TOP VIEW



Features

- Differential input range ±2.3V
- 250MHz 3dB bandwidth
- 800V/μs slew rate
- 60mA maximum output current
- Single 5V or dual ±5V supplies
- Low power - 5mA to 6mA per channel
- Pb-free available (RoHS compliant)

Applications

- Twisted-pair receivers
- Differential line receivers
- VGA over twisted-pair
- ADSL/HDSL receivers
- Differential to single-ended amplification
- Reception of analog signals in a noisy environment

Ordering Information

PART NUMBER	PART MARKING	PACKAGE	PKG. DWG. #
EL5172ISZ (Note)	5172ISZ	8 Ld SOIC (150 mil) (Pb-free)	M8.15E
EL5172ISZ-T7* (Note)	5172ISZ	8 Ld SOIC (150 mil) (Pb-free)	M8.15E
EL5172ISZ-T13* (Note)	5172ISZ	8 Ld SOIC (150 mil) (Pb-free)	M8.15E
EL5172IYZ (Note)	BAAWA	8 Ld MSOP (3.0mm) (Pb-free)	M8.118A
EL5172IYZ-T7* (Note)	BAAWA	8 Ld MSOP (3.0mm) (Pb-free)	M8.118A
EL5172IYZ-T13* (Note)	BAAWA	8 Ld MSOP (3.0mm) (Pb-free)	M8.118A
EL5372IUZ (Note) (No longer available, recommended replacement: EL5375IUZ)	EL5372IUZ	24 Ld QSOP (150 mil) (Pb-free)	MDP0040
EL5372IUZ-T7* (Note) (No longer available, recommended replacement: EL5375IUZ-T7)	EL5372IUZ	24 Ld QSOP (150 mil) (Pb-free)	MDP0040
EL5372IUZ-T13* (Note) (No longer available, recommended replacement: EL5375IUZ-T13)	EL5372IUZ	24 Ld QSOP (150 mil) (Pb-free)	MDP0040

*Please refer to TB347 for details on reel specifications.

NOTE: These Intersil Pb-free plastic packaged products employ special Pb-free material sets, molding compounds/die attach materials, and 100% matte tin plate plus anneal (e3 termination finish, which is RoHS compliant and compatible with both SnPb and Pb-free soldering operations). Intersil Pb-free products are MSL classified at Pb-free peak reflow temperatures that meet or exceed the Pb-free requirements of IPC/JEDEC J STD-020.

Absolute Maximum Ratings (T_A = +25°C)

Supply Voltage (V_{S+} to V_{S-}) 12V
 Supply Voltage Rate-of-rise (dV/dT) 1V/μs
 Input Voltage (IN+, IN- to V_{S+}, V_{S-}) V_{S-} - 0.3V to V_{S+} + 0.3V
 Differential Input Voltage (IN+ to IN-) ±4.8V
 Maximum Output Current ±60mA

Thermal Information

Operating Junction Temperature +135°C
 Ambient Operating Temperature -40°C to +85°C
 Storage Temperature Range -65°C to +150°C
 Power Dissipation See Curves
 Pb-free reflow profile see link below
<http://www.intersil.com/pbfree/Pb-FreeReflow.asp>

CAUTION: Do not operate at or near the maximum ratings listed for extended periods of time. Exposure to such conditions may adversely impact product reliability and result in failures not covered by warranty.

IMPORTANT NOTE: All parameters having Min/Max specifications are guaranteed. Typ values are for information purposes only. Unless otherwise noted, all tests are at the specified temperature and are pulsed tests, therefore: T_J = T_C = T_A

Electrical Specifications V_{S+} = +5V, V_{S-} = -5V, T_A = +25°C, V_{IN} = 0V, R_L = 500Ω, R_F = 0, R_G = OPEN, C_L = 2.7pF, Unless Otherwise Specified.

PARAMETER	DESCRIPTION	CONDITIONS	MIN	TYP	MAX	UNIT
AC PERFORMANCE						
BW	-3dB Bandwidth	A _V = 1, C _L = 2.7pF		250		MHz
		A _V = 2, R _F = 1000Ω, C _L = 2.7pF		70		MHz
		A _V = 10, R _F = 1000Ω, C _L = 2.7pF		10		MHz
BW	±0.1dB Bandwidth	A _V = 1, C _L = 2.7pF		25		MHz
SR	Slew Rate	V _{OUT} = 3V _{P-P} , 20% to 80%, EL5172	550	800	1000	V/μs
		V _{OUT} = 3V _{P-P} , 20% to 80%, EL5372	550	700	1000	V/μs
t _{STL}	Settling Time to 0.1%	V _{OUT} = 2V _{P-P}		10		ns
t _{OVR}	Output Overdrive Recovery Time			20		ns
GBWP	Gain Bandwidth Product			100		MHz
V _{REFBW} (-3dB)	V _{REF} -3dB Bandwidth	A _V = 1, C _L = 2.7pF		120		MHz
V _{REFSR}	V _{REF} Slew Rate	V _{OUT} = 2V _{P-P} , 20% to 80%		600		V/μs
V _N	Input Voltage Noise	at f = 11kHz		26		nV/√Hz
I _N	Input Current Noise	at f = 11kHz		2		pA/√Hz
HD2	Second Harmonic Distortion	V _{OUT} = 1V _{P-P} , 5MHz		-66		dBc
		V _{OUT} = 2V _{P-P} , 50MHz		-63		dBc
HD3	Third Harmonic Distortion	V _{OUT} = 1V _{P-P} , 5MHz		-84		dBc
		V _{OUT} = 2V _{P-P} , 50MHz		-76		dBc
dG	Differential Gain at 3.58MHz	R _L = 150Ω, A _V = 2		0.04		%
dθ	Differential Phase at 3.58MHz	R _L = 150Ω, A _V = 2		0.41		°
e _S	Channel Separation at 100kHz	EL5372 only		90		dB
INPUT CHARACTERISTICS						
V _{OS}	Input Referred Offset Voltage			±7	±25	mV
I _{IN}	Input Bias Current (V _{IN} , V _{INB} , V _{REF})		-14	-6	-3	μA
R _{IN}	Differential Input Resistance			300		kΩ
C _{IN}	Differential Input Capacitance			1		pF
DMIR	Differential Input Range		±2.1	±2.38	±2.5	V
CMIR+	Common Mode Positive Input Range at V _{IN+} , V _{IN-}		3.3	3.5		V
CMIR-	Common Mode Positive Input Range at V _{IN+} , V _{IN-}			-4.5	-4.3	
V _{REFIN+}	Reference Input Positive Voltage Range	V _{IN+} = V _{IN-} = 0V	3.3	3.7		V

Electrical Specifications $V_{S+} = +5V$, $V_{S-} = -5V$, $T_A = +25^{\circ}C$, $V_{IN} = 0V$, $R_L = 500\Omega$, $R_F = 0$, $R_G = OPEN$, $C_L = 2.7pF$, Unless Otherwise Specified. (Continued)

PARAMETER	DESCRIPTION	CONDITIONS	MIN	TYP	MAX	UNIT
V_{REFIN-}	Reference Input Negative Voltage Range	$V_{IN+} = V_{IN-} = 0V$		-3.9	-3.6	
CMRR	Input Common Mode Rejection Ratio	$V_{IN} = \pm 2.5V$	75	95		dB
Gain	Gain Accuracy	$V_{IN} = 1$	0.985	1	1.015	V
OUTPUT CHARACTERISTICS						
V_{OUT}	Positive Output Voltage Swing	$R_L = 500\Omega$ to GND	3.3	3.63		V
	Negative Output Voltage Swing	$R_L = 500\Omega$ to GND		-3.87	-3.5	V
$I_{OUT(Max)}$	Maximum Output Current	$R_L = 10\Omega$	± 60	± 95		mA
R_{OUT}	Output Impedance			100		m Ω
SUPPLY						
V_{SUPPLY}	Supply Operating Range	V_{S+} to V_{S-}	4.75		11	V
$I_S (on)$	Power Supply Current Per Channel - Enabled		4.6	5.6	7	mA
$I_S (off)^+$	Positive Power Supply Current - Disabled	\overline{EN} pin tied to 4.8V, EL5172		80	100	μA
		\overline{EN} pin tied to 4.8V, EL5372		1.7	5	μA
$I_S (off)^-$	Negative Power Supply Current - Disabled		-150	-120	-90	μA
PSRR	Power Supply Rejection Ratio	V_S from $\pm 4.5V$ to $\pm 5.5V$	50	58		dB
ENABLE						
t_{EN}	Enable Time			150		ns
t_{DS}	Disable Time			1.4		μs
V_{IH}	\overline{EN} Pin Voltage for Power-up				$V_{S+} - 1.5$	V
V_{IL}	\overline{EN} Pin Voltage for Shutdown		$V_{S+} - 0.5$			V
I_{IH-EN}	\overline{EN} Pin Input Current High Per Channel	At $V_{EN} = 5V$		40	60	μA
I_{IL-EN}	\overline{EN} Pin Input Current Low Per Channel	At $V_{EN} = 0V$	-10	-3		μA

Pin Descriptions

EL5172	EL5372	PIN NAME	PIN FUNCTION
1		FB	Feedback input
2		IN+	Non-inverting input
3		IN-	Inverting input
4		REF	Sets the common mode output voltage level
5		$\overline{\text{EN}}$	Enabled when this pin is floating or the applied voltage $\leq V_{S+} - 1.5$
6		VS+	Positive supply voltage
7		VS-	Negative supply voltage
8		OUT	Output voltage
	1, 5, 9	REF1, REF2, REF3	Reference input, controls common-mode output voltage
	2, 6, 10	INP1, INP2, INP3	Non-inverting inputs
	3, 7, 11	INN1, INN2, INN3	Inverting inputs
	4, 8, 12, 18, 21, 24	NC	No connect; grounded for best crosstalk performance
	13, 16, 22	OUT3, OUT2, OUT1	Non-inverting outputs
	14, 17, 23	FB3, FB2, FB1	Feedback from outputs
	15	$\overline{\text{EN}}$	Enabled when this pin is floating or the applied voltage $\leq V_{S+} - 1.5$
	19	VSN	Negative supply
	20	VSP	Positive supply

Typical Performance Curves



FIGURE 1. FREQUENCY RESPONSE vs SUPPLY VOLTAGE



FIGURE 2. FREQUENCY RESPONSE vs SUPPLY VOLTAGE



FIGURE 3. FREQUENCY RESPONSE vs VARIOUS GAIN



FIGURE 4. FREQUENCY RESPONSE vs C_L



FIGURE 5. FREQUENCY RESPONSE vs C_L

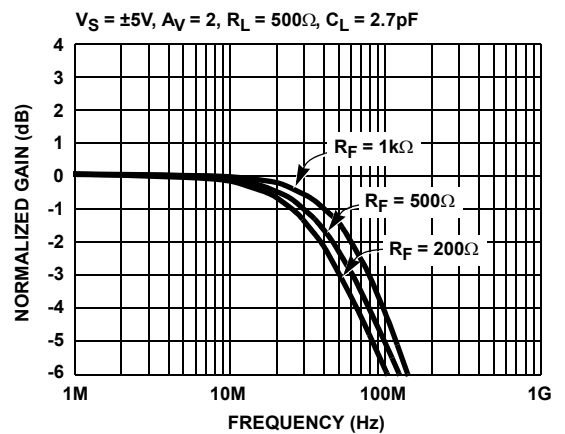

FIGURE 6. FREQUENCY RESPONSE FOR VARIOUS R_F

Typical Performance Curves (Continued)

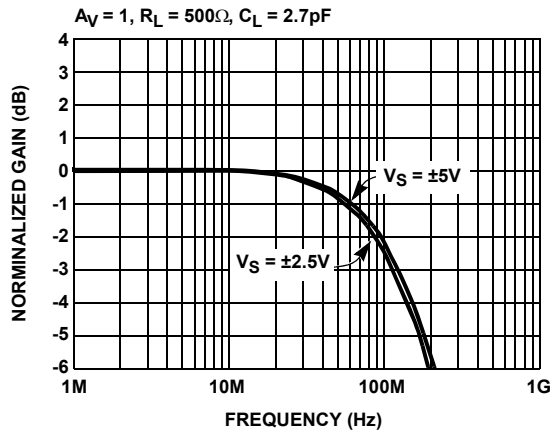

FIGURE 7. FREQUENCY RESPONSE FOR V_{REF}



FIGURE 8. OPEN LOOP GAIN

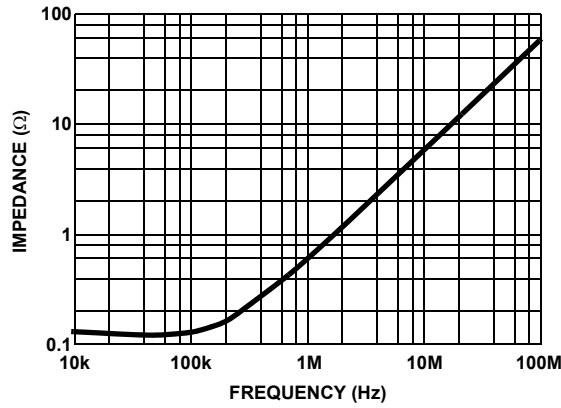

FIGURE 9. OUTPUT IMPEDANCE vs FREQUENCY

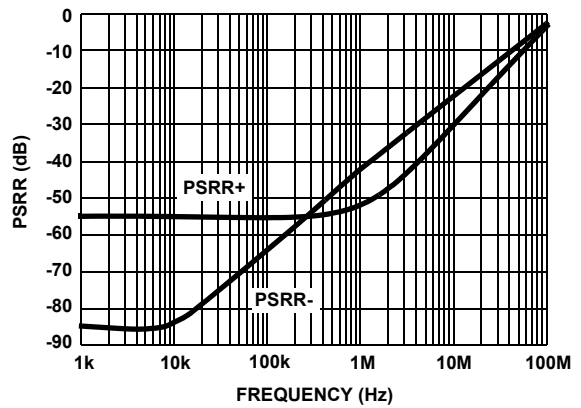

FIGURE 10. PSRR vs FREQUENCY

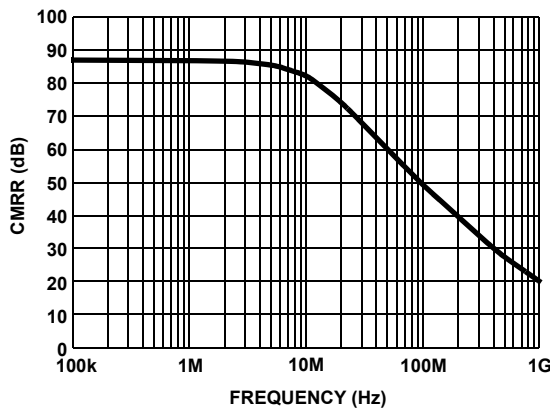

FIGURE 11. CMRR vs FREQUENCY

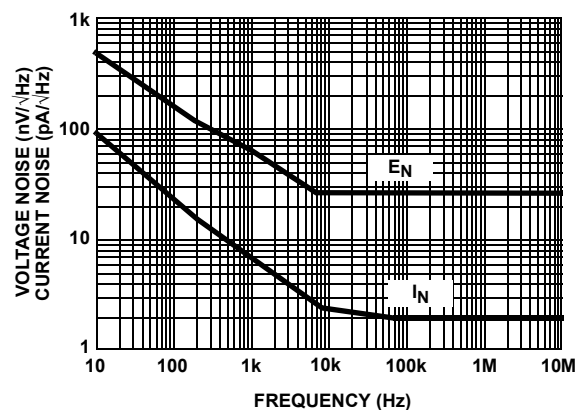

FIGURE 12. VOLTAGE AND CURRENT NOISE vs FREQUENCY

Typical Performance Curves (Continued)



FIGURE 13. CHANNEL ISOLATION vs FREQUENCY



FIGURE 14. HARMONIC DISTORTION vs OUTPUT VOLTAGE



FIGURE 15. HARMONIC DISTORTION vs LOAD RESISTANCE



FIGURE 16. HARMONIC DISTORTION vs FREQUENCY



FIGURE 17. SMALL SIGNAL TRANSIENT RESPONSE

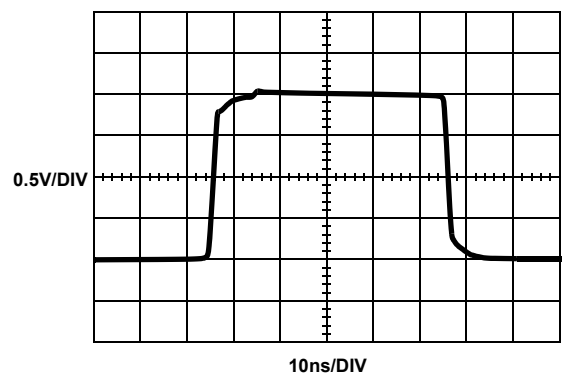

FIGURE 18. LARGE SIGNAL TRANSIENT RESPONSE

Typical Performance Curves (Continued)

M = 100ns, CH1 = 200mV/DIV, CH2 = 5V/DIV

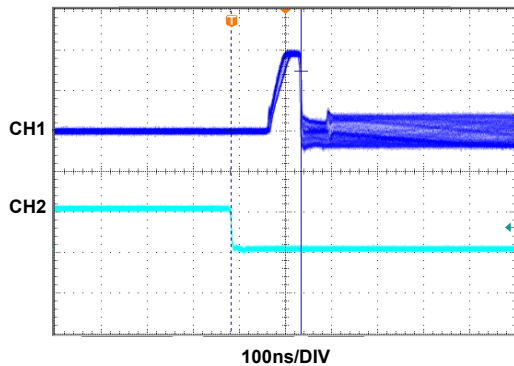

FIGURE 19. ENABLED RESPONSE

M = 400ns, CH1 = 200mV/DIV, CH2 = 5V/DIV

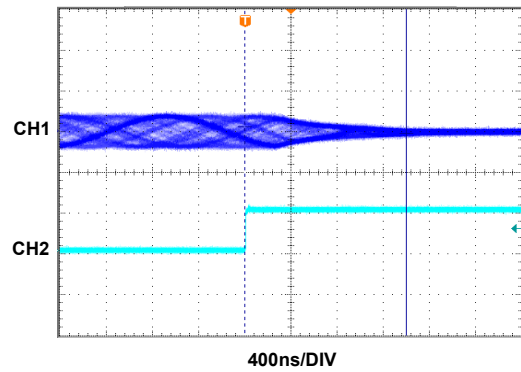

FIGURE 20. DISABLED RESPONSE

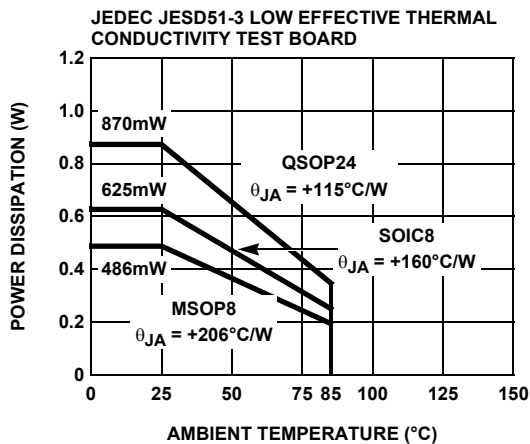

FIGURE 21. PACKAGE POWER DISSIPATION vs AMBIENT TEMPERATURE

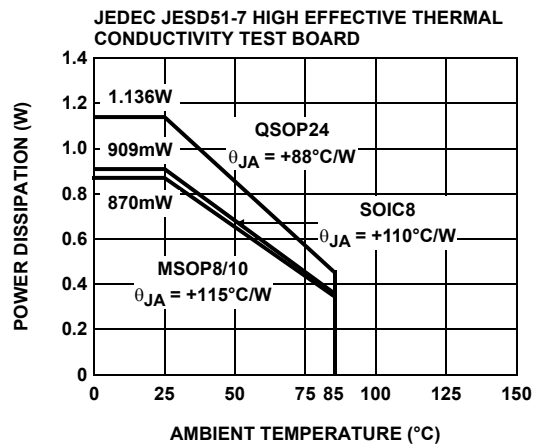
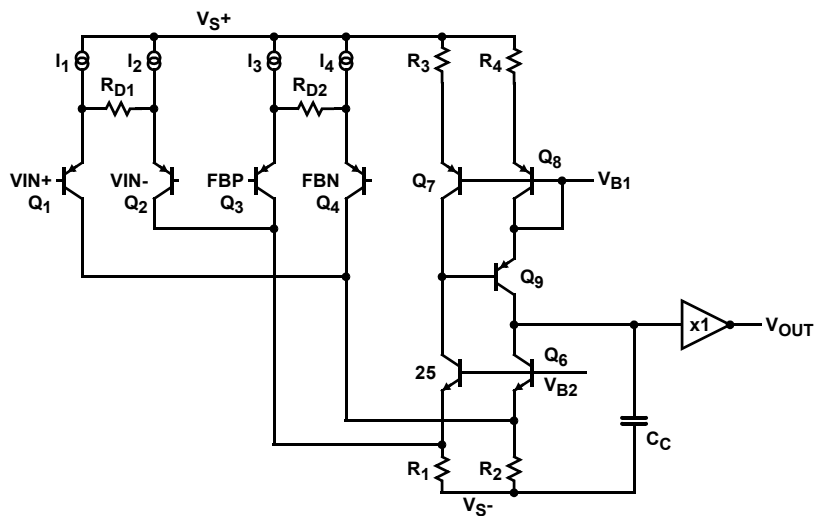

FIGURE 22. PACKAGE POWER DISSIPATION vs AMBIENT TEMPERATURE

Simplified Schematic



Description of Operation and Application Information

Product Description

The EL5172 and EL5372 are wide bandwidth, low power and single/differential ended to single-ended output amplifiers. The EL5172 is a single channel differential to single-ended amplifier. The EL5372 is a triple channel differential to single-ended amplifier. The EL5172 and EL5372 are internally compensated for closed loop gain of +1 or greater. Connected in gain of 1 and driving a 500Ω load, the EL5172 and EL5372 have a -3dB bandwidth of 250MHz. Driving a 150Ω load at gain of 2, the bandwidth is about 50MHz. The bandwidth at the REF input is about 450MHz. The EL5172 and EL5372 are available with a power-down feature to reduce the power while the amplifier is disabled.

Input, Output and Supply Voltage Range

The EL5172 and EL5372 have been designed to operate with a single supply voltage of 5V to 10V or split supplies with its total voltage from 5V to 10V. The amplifiers have an input common mode voltage range from -4.3V to 3.3V for ±5V supply. The differential mode input range (DMIR) between the two inputs is about from -2.3V to +2.3V. The input voltage range at the REF pin is from -3.6V to 3.3V. If the input common mode or differential mode signal is outside the above-specified ranges, it will cause the output signal to be distorted.

The output of the EL5172 and EL5372 can swing from -3.8V to 3.6V at 500Ω load at ±5V supply. As the load resistance becomes lower, the output swing is reduced respectively.

Overall Gain Settings

The gain setting for the EL5172 and the EL5372 is similar to the conventional operational amplifier. The output voltage is equal to the difference of the inputs plus V_{REF} and then times the gain, as expressed in Equation 1.

$$V_O = (V_{IN+} - V_{IN-} + V_{REF}) \times \left(1 + \frac{R_F}{R_G}\right) \quad (\text{EQ. 1})$$



FIGURE 23.

Choice of Feedback Resistor and Gain Bandwidth Product

For applications that require a gain of +1, no feedback resistor is required; just short the OUT pin to the FB pin. For gains greater than +1, the feedback resistor forms a pole with the parasitic capacitance at the inverting input. As this pole becomes smaller, the amplifier's phase margin is reduced. This causes ringing in the time domain and peaking in the frequency domain. Therefore, R_F has some maximum value that should not be exceeded for optimum performance. If a large value of R_F must be used, a small capacitor in the few Pico farad range in parallel with R_F can help to reduce the ringing and peaking at the expense of reducing the bandwidth.

The bandwidth of the EL5172 and EL5372 depends on the load and the feedback network. R_F and R_G appear in parallel with the load for gains other than +1. As this combination gets smaller, the bandwidth falls off. Consequently, R_F also has a minimum value that should not be exceeded for optimum bandwidth performance. For a gain of +1, $R_F = 0$ is optimum. For the gains other than +1, optimum response is obtained with R_F between 500Ω to 1kΩ. For $A_V = 2$ and $R_F = R_G = 1k\Omega$, the BW is about 80MHz and the frequency response is very flat.

The EL5172 and EL5372 have a gain bandwidth product of 100MHz. For gains ≥ 5 , its bandwidth can be predicted using Equation 2:

$$\text{Gain} \times \text{BW} = 100\text{MHz} \quad (\text{EQ. 2})$$

Driving Capacitive Loads and Cables

The EL5172 and EL5372 can drive 56pF capacitance in parallel with 500Ω load to ground with 4dB of peaking at a gain of +1. If less peaking is desired in applications, a small series resistor (usually between 5Ω to 50Ω) can be placed in series with each output to eliminate most peaking. However, this will reduce the gain slightly. If the gain setting is greater than 1, the gain resistor R_G can then be chosen to make-up for any gain loss which may be created by the additional series resistor at the output.

When used as a cable driver, double termination is always recommended for reflection-free performance. For those applications, a back-termination series resistor at the amplifier's output will isolate the amplifier from the cable and allow extensive capacitive drive. However, other applications may have high capacitive loads without a back-termination resistor. Again, a small series resistor at the output can help to reduce peaking.

Disable/Power-Down

The EL5172 and EL5372 can be disabled and its outputs placed in a high impedance state. The turn-off time is about 1.4μs and the turn-on time is about 150ns. When disabled, the amplifier's supply current is reduced to 80μA for I_{S+} and 120μA for I_{S-} typically, thereby effectively eliminating the

power consumption. The amplifier's power-down can be controlled by standard CMOS signal levels at the ENABLE pin. The applied logic signal is relative to V_{S+} pin. Letting the \overline{EN} pin float or applying a signal that is less than 1.5V below V_{S+} will enable the amplifier. The amplifier will be disabled when the signal at \overline{EN} pin is above $V_{S+} - 0.5V$. If a TTL signal is used to control the enabled/disabled function, Figure 24 could be used to convert the TTL signal to CMOS signal.



FIGURE 24.

Output Drive Capability

The EL5172 and EL5372 have internal short circuit protection. Its typical short circuit current is $\pm 95mA$. If the output is shorted indefinitely, the power dissipation could easily increase such that the part will be destroyed. Maximum reliability is maintained if the output current never exceeds $\pm 60mA$. This limit is set by the design of the internal metal interconnections.

Power Dissipation

With the high output drive capability of the EL5172 and EL5372, it is possible to exceed the $+135^{\circ}C$ absolute maximum junction temperature under certain load current conditions. Therefore, it is important to calculate the maximum junction temperature for the application to determine if the load conditions or package types need to be modified for the amplifier to remain in the safe operating area.

The maximum power dissipation allowed in a package is determined according to Equation 3:

$$PD_{MAX} = \frac{T_{JMAX} - T_{AMAX}}{\theta_{JA}} \quad (EQ. 3)$$

- T_{JMAX} = Maximum junction temperature
- T_{AMAX} = Maximum ambient temperature
- θ_{JA} = Thermal resistance of the package

Assuming the REF pin is tied to GND for $V_S = \pm 5V$ application, the maximum power dissipation actually produced by an IC is the total quiescent supply current times the total power supply voltage, plus the power in the IC due to the load, or:

For sourcing, use Equation 4:

$$PD_{MAX} = \left[V_S \times I_{SMAX} + (V_{S+} - V_{OUT}) \times \frac{V_{OUT}}{R_{LOAD}} \right] \times i \quad (EQ. 4)$$

For sinking, use Equation 5:

$$PD_{MAX} = [V_S \times I_{SMAX} + (V_{OUT} - V_{S-}) \times I_{LOAD}] \times i \quad (EQ. 5)$$

Where:

- V_S = Total supply voltage
- I_{SMAX} = Maximum quiescent supply current per channel
- V_{OUT} = Maximum output voltage of the application
- R_{LOAD} = Load resistance
- I_{LOAD} = Load current
- i = Number of channels

By setting the two PD_{MAX} equations equal to each other, we can solve the output current and R_{LOAD} to avoid the device overheat.

Power Supply Bypassing and Printed Circuit Board Layout

As with any high frequency device, a good printed circuit board layout is necessary for optimum performance. Lead lengths should be as short as possible. The power supply pin must be well bypassed to reduce the risk of oscillation. For normal single supply operation, where the V_{S-} pin is connected to the ground plane, a single $4.7\mu F$ tantalum capacitor in parallel with a $0.1\mu F$ ceramic capacitor from V_{S+} to GND will suffice. This same capacitor combination should be placed at each supply pin to ground if split supplies are to be used. In this case, the V_{S-} pin becomes the negative supply rail.

For good AC performance, parasitic capacitance should be kept to a minimum. Use of wire wound resistors should be avoided because of their additional series inductance. Use of sockets should also be avoided if possible. Sockets add parasitic inductance and capacitance that can result in compromised performance. Minimizing parasitic capacitance at the amplifier's inverting input pin is very important. The feedback resistor should be placed very close to the inverting input pin. Strip line design techniques are recommended for the signal traces.

Typical Applications



FIGURE 25. TWISTED PAIR CABLE RECEIVER



FIGURE 26. COMPENSATED LINE RECEIVER

As the signal is transmitted through a cable, the high frequency signal will be attenuated. One way to compensate for this loss is to boost the high frequency gain at the receiver side.

Level Shifter and Signal Summer

The EL5172 and EL5372 contains two pairs of differential pair input stages, which make sure that the inputs are all high impedance inputs. To take advantage of the two high impedance inputs, the EL5172 and EL5372 can be used as a signal summer to add two signals together. One signal can be applied to VIN+, the second signal can be applied to REF and VIN- is ground. The output is equal to Equation 6:

$$V_O = (V_{IN} + V_{REF}) \times \text{Gain} \tag{EQ. 6}$$

Also, the EL5172 and EL5372 can be used as a level shifter by applying a level control signal to the REF input.

Revision History

The revision history provided is for informational purposes only and is believed to be accurate, but not warranted. Please go to the web to make sure that you have the latest revision.

DATE	REVISION	CHANGE
August 11, 2015	FN7311.11	Updated Ordering Information table on page 2.

About Intersil

Intersil Corporation is a leading provider of innovative power management and precision analog solutions. The company's products address some of the largest markets within the industrial and infrastructure, mobile computing and high-end consumer markets.

For the most updated datasheet, application notes, related documentation and related parts, please see the respective product information page found at www.intersil.com.

You may report errors or suggestions for improving this datasheet by visiting www.intersil.com/ask.

Reliability reports are also available from our website at www.intersil.com/support

Package Outline Drawing

M8.15E

8 LEAD NARROW BODY SMALL OUTLINE PLASTIC PACKAGE

Rev 0, 08/09



NOTES:

1. Dimensions are in millimeters.
Dimensions in () for Reference Only.
2. Dimensioning and tolerancing conform to AMSE Y14.5m-1994.
3. Unless otherwise specified, tolerance : Decimal ± 0.05
4. Dimension does not include interlead flash or protrusions.
Interlead flash or protrusions shall not exceed 0.25mm per side.
5. The pin #1 identifier may be either a mold or mark feature.
6. Reference to JEDEC MS-012.

Package Outline Drawing

M8.118A

8 LEAD MINI SMALL OUTLINE PLASTIC PACKAGE (MSOP)

Rev 0, 9/09



TOP VIEW



SIDE VIEW 2

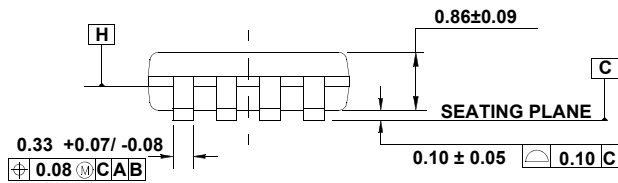

SIDE VIEW 1

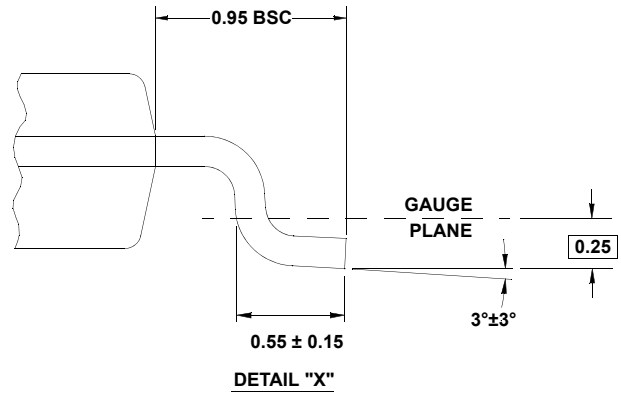

DETAIL "X"

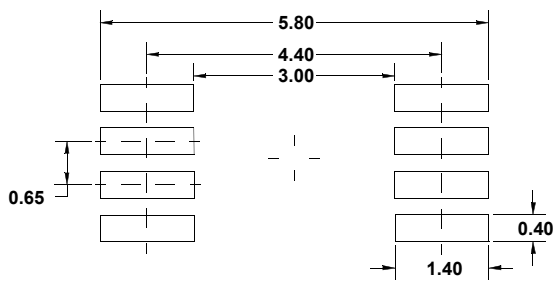

TYPICAL RECOMMENDED LAND PATTERN

NOTES:

1. Dimensions are in millimeters.
2. Dimensioning and tolerancing conform to JEDEC MO-187-AA and AMSE Y14.5m-1994.
3. Plastic or metal protrusions of 0.15mm max per side are not included.
4. Plastic interlead protrusions of 0.25mm max per side are not included.
5. Dimensions "D" and "E1" are measured at Datum Plane "H".
6. This replaces existing drawing # MDP0043 MSOP 8L.

Quarter Size Outline Plastic Packages Family (QSOP)

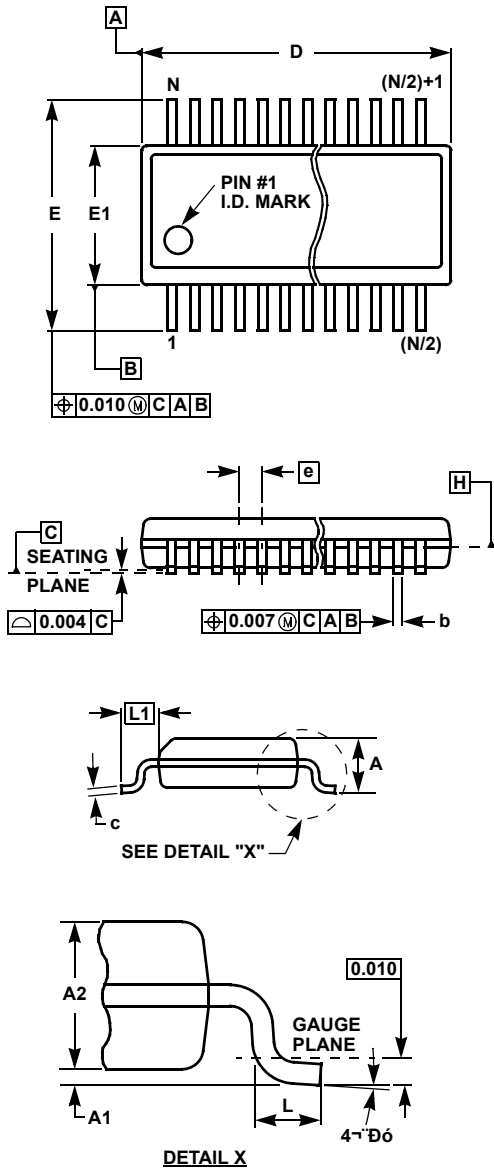

MDP0040
QUARTER SIZE OUTLINE PLASTIC PACKAGES FAMILY

SYMBOL	INCHES			TOLERANCE	NOTES
	QSOP16	QSOP24	QSOP28		
A	0.068	0.068	0.068	Max.	-
A1	0.006	0.006	0.006	±0.002	-
A2	0.056	0.056	0.056	±0.004	-
b	0.010	0.010	0.010	±0.002	-
c	0.008	0.008	0.008	±0.001	-
D	0.193	0.341	0.390	±0.004	1, 3
E	0.236	0.236	0.236	±0.008	-
E1	0.154	0.154	0.154	±0.004	2, 3
e	0.025	0.025	0.025	Basic	-
L	0.025	0.025	0.025	±0.009	-
L1	0.041	0.041	0.041	Basic	-
N	16	24	28	Reference	-

Rev. F 2/07

NOTES:

1. Plastic or metal protrusions of 0.006" maximum per side are not included.
2. Plastic interlead protrusions of 0.010" maximum per side are not included.
3. Dimensions "D" and "E1" are measured at Datum Plane "H".
4. Dimensioning and tolerancing per ASME Y14.5M-1994.

© Copyright Intersil Americas LLC 2002-2015. All Rights Reserved.
 All trademarks and registered trademarks are the property of their respective owners.

For additional products, see www.intersil.com/en/products.html

Intersil products are manufactured, assembled and tested utilizing ISO9001 quality systems as noted in the quality certifications found at www.intersil.com/en/support/qualandreliability.html

Intersil products are sold by description only. Intersil may modify the circuit design and/or specifications of products at any time without notice, provided that such modification does not, in Intersil's sole judgment, affect the form, fit or function of the product. Accordingly, the reader is cautioned to verify that datasheets are current before placing orders. Information furnished by Intersil is believed to be accurate and reliable. However, no responsibility is assumed by Intersil or its subsidiaries for its use; nor for any infringements of patents or other rights of third parties which may result from its use. No license is granted by implication or otherwise under any patent or patent rights of Intersil or its subsidiaries.

For information regarding Intersil Corporation and its products, see www.intersil.com

Компания «Океан Электроники» предлагает заключение долгосрочных отношений при поставках импортных электронных компонентов на взаимовыгодных условиях!

Наши преимущества:

- Поставка оригинальных импортных электронных компонентов напрямую с производств Америки, Европы и Азии, а так же с крупнейших складов мира;
- Широкая линейка поставок активных и пассивных импортных электронных компонентов (более 30 млн. наименований);
- Поставка сложных, дефицитных, либо снятых с производства позиций;
- Оперативные сроки поставки под заказ (от 5 рабочих дней);
- Экспресс доставка в любую точку России;
- Помощь Конструкторского Отдела и консультации квалифицированных инженеров;
- Техническая поддержка проекта, помощь в подборе аналогов, поставка прототипов;
- Поставка электронных компонентов под контролем ВП;
- Система менеджмента качества сертифицирована по Международному стандарту ISO 9001;
- При необходимости вся продукция военного и аэрокосмического назначения проходит испытания и сертификацию в лаборатории (по согласованию с заказчиком);
- Поставка специализированных компонентов военного и аэрокосмического уровня качества (Xilinx, Altera, Analog Devices, Intersil, Interpoint, Microsemi, Actel, Aeroflex, Peregrine, VPT, Syfer, Eurofarad, Texas Instruments, MS Kennedy, Miteq, Cobham, E2V, MA-COM, Hittite, Mini-Circuits, General Dynamics и др.);

Компания «Океан Электроники» является официальным дистрибьютором и эксклюзивным представителем в России одного из крупнейших производителей разъемов военного и аэрокосмического назначения «JONHON», а так же официальным дистрибьютором и эксклюзивным представителем в России производителя высокотехнологичных и надежных решений для передачи СВЧ сигналов «FORSTAR».



JONHON

«JONHON» (основан в 1970 г.)

Разъемы специального, военного и аэрокосмического назначения:

(Применяются в военной, авиационной, аэрокосмической, морской, железнодорожной, горно- и нефтедобывающей отраслях промышленности)

«FORSTAR» (основан в 1998 г.)

ВЧ соединители, коаксиальные кабели, кабельные сборки и микроволновые компоненты:

(Применяются в телекоммуникациях гражданского и специального назначения, в средствах связи, РЛС, а так же военной, авиационной и аэрокосмической отраслях промышленности).



Телефон: 8 (812) 309-75-97 (многоканальный)

Факс: 8 (812) 320-03-32

Электронная почта: ocean@oceanchips.ru

Web: <http://oceanchips.ru/>

Адрес: 198099, г. Санкт-Петербург, ул. Калинина, д. 2, корп. 4, лит. А