

MAX12900

Ultra-Low-Power 4-20mA Sensor Transmitter

General Description

The MAX12900 is an ultra-low-power, highly integrated 4-20mA sensor transmitter. The MAX12900 integrates ten building blocks in a small package: a wide input supply voltage LDO, two conditioner circuits for pulse-width-modulated (PWM) inputs, two low-power, low-drift, general-purpose operational amplifiers (op amp) one wide bandwidth, zero-offset drift operational amplifier; two diagnostic comparators, a power-up sequencer with power good output to allow for a smooth power-up, and a low-drift voltage reference.

The MAX12900 converts PWM data from a microcontroller into current over a 4-20mA loop with two, three, or four-wire configurations.

The equivalent to an ultra-low-power, high-resolution, digital-to-analog converter is realized with the combination of two-PWM signals received from a microcontroller, the two conditioner circuits, and an active filter built with the integrated low-power op amp. The outputs of the two conditioner circuits provide a stable PWM amplitude over voltage supply and temperature variation. The wide bandwidth amplifier, in combination with a discrete transistor, converts a voltage input into a current output and allows HART and Foundation Fieldbus H1 signal modulation. The zero-offset operational amplifier and the low-drift voltage reference provide negligible error over wide temperature. The low-power operational amplifier and comparators provide building blocks for enhanced diagnostic features. Supply rail monitoring, output current readback, open circuit and failure detection are a few examples of diagnostic features. All these features, as well as ultra-low-power and high accuracy make the MAX12900 ideal for loop-powered smart sensor transmitters for industrial application.

The MAX12900 is available in 5mm x 5mm 32-pin TQFN package and operates over a wide industrial temperature range of -40°C to +125°C.

Benefits and Features

- Wide Input Supply Range: 4.0V to 36V
- Ultra-Low-Power Consumption: 170µA (typ)
- High Linearity: 0.01% (Max Error)
- High Resolution: Up to 16 Bit
- Low Drift Voltage Reference: 10ppm/°C max
- Wide Temperature Range: -40°C to +125°C
- Small Package: 5mm x 5mm x 0.8mm 32-pin TQFN

Applications

- Loop-Powered 4-20mA Current Transmitter
- Smart Sensors
- Remote Instrumentation
- Industrial Automation and Process Control

Ordering Information appears at end of data sheet.

Functional Block Diagram

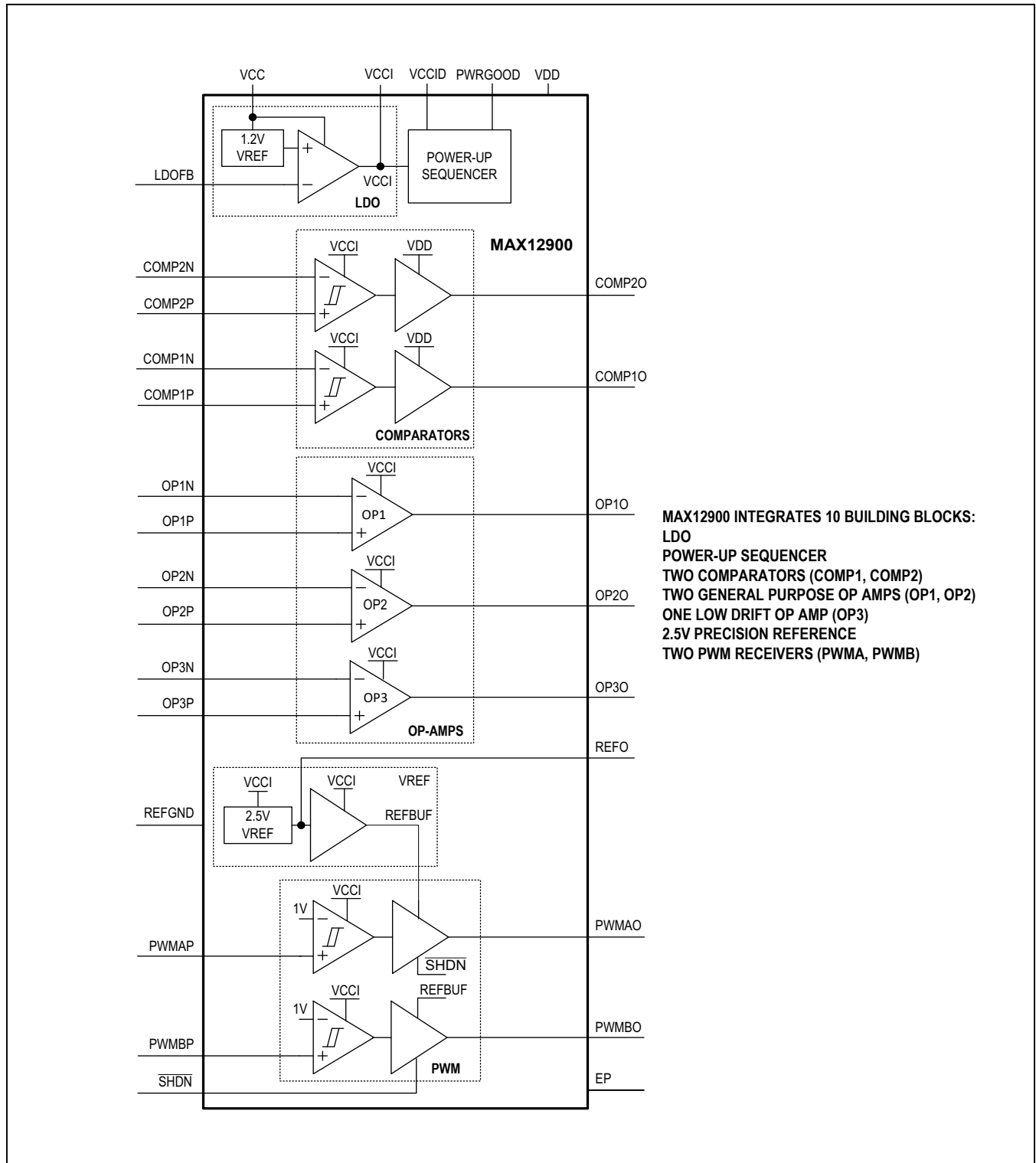

MAX12900 INTEGRATES 10 BUILDING BLOCKS:
 LDO
 POWER-UP SEQUENCER
 TWO COMPARATORS (COMP1, COMP2)
 TWO GENERAL PURPOSE OP AMPS (OP1, OP2)
 ONE LOW DRIFT OP AMP (OP3)
 2.5V PRECISION REFERENCE
 TWO PWM RECEIVERS (PWMA, PWMB)

Absolute Maximum Ratings

VCC to GND-0.3V to +40V
 VCC to VCCI-0.3V to +40V
 VCCI and VCCID to GND-0.3V to +6V
 VCCI to VCCID.....-0.3V to +0.3V
 VDD to GND-0.3V to +6V
 PWRGOOD to GND-0.3V to VCCI + 0.3V
 LDOFB to GND-0.3V to VCCI + 0.3V
 I/C and REFGND to GND-0.3V to + 0.3V
 SHDN to GND-0.3V to VCCI + 0.3V
 REFO to GND-0.3V to VCCI + 0.3V

Op Amps

OP10, OP20, OP30 to GND-0.3V to VCCI + 0.3V
 OP1P, OP1N, OP2P, OP2N, OP3P,
 OP3N to GND.....-0.3V to min [4.5V, VCCI + 0.3V]
 Current into OP1P, OP1N, OP2P, OP2N,
 OP3P, OP3N..... ±20mA
 Current into OP3O..... ±30mA
 Output Short-Circuit Duration for OP1 and
 OP2 to VCCI or GND Continuous

Comparators

COMP1P, COMP1N, COMP2P, COMP2N
 to GND.....-0.3V to VCCI + 0.3V
 COMP1O, COMP2O to GND-0.3V to VDD + 0.3V
 Current into COMP1P, COMP1N,
 COMP2P, COMP2N ±20mA
 Output Short-Circuit Duration to
 VDD or GND..... Continuous

PWM Conditioners

PWMAP, PWMBP to GND.....-0.3V to VCCI + 0.3V
 PWMAO, PWMBO to GND-0.3V to VCCI + 0.3V
 Current into PWMAP, PWMBP..... ±20mA
 Output Short-Circuit Duration to VCCI or GND..... Continuous

Continuous Power Dissipation (T_A = +70°C,
 derate 35.7mW/°C above +70°C).....2857.1mW
 Operating Temperature Range..... -40°C to +125°C
 Functional Temperature Range
 (Startup condition) -55°C to +125°C
 Maximum Junction Temperature +150°C
 Storage Temperature Range -65°C to +150°C
 Soldering Temperature (reflow) +260°C
 Lead Temperature +300°C

Stresses beyond those listed under "Absolute Maximum Ratings" may cause permanent damage to the device. These are stress ratings only, and functional operation of the device at these or any other conditions beyond those indicated in the operational sections of the specifications is not implied. Exposure to absolute maximum rating conditions for extended periods may affect device reliability.

Package Information

32 TQFN

PACKAGE CODE	T3255
Outline Number	21-0140
Land Pattern Number	90-0015
Thermal Resistance, Four-Layer Board:	
Junction to Ambient (θ _{JA})	40.2°C/W
Junction to Case (θ _{JC})	2.0°C/W

For the latest package outline information and land patterns (footprints), go to www.maximintegrated.com/packages. Note that a "+", "#", or "-" in the package code indicates RoHS status only. Package drawings may show a different suffix character, but the drawing pertains to the package regardless of RoHS status.

Note 1: Package thermal resistances were obtained using the method described in JEDEC specification JESD51-7, using a four-layer board. For detailed information on package thermal considerations, refer to www.maximintegrated.com/thermal-tutorial.

Electrical Characteristics

Voltage Reference

$V_{CC1} = +3.0V$ to $+5.5V$, $V_{GND} = 0V$, $T_A = T_{MIN}$ to T_{MAX} , unless otherwise noted. Typical values are at $T_A = +25^\circ C$, $V_{CC1} = +3.3V$. (Note 1)

PARAMETER	SYMBOL	CONDITIONS	MIN	TYP	MAX	UNITS
VOLTAGE REFERENCE 2.5V						
STATIC						
Supply Voltage	V_{CC1}	Guaranteed by line regulation test	3.0		5.5	V
V_{CC1} Line Regulation	$\frac{\Delta V_{REF}}{\Delta V_{CC1}}$	$3.0V \leq V_{CC1} \leq 5.5V$		20	140	$\mu V/V$
V_{CC} Line Regulation	$\frac{\Delta V_{REF}}{\Delta V_{CC}}$	$4.3V \leq V_{CC} \leq 36V$, $V_{CC1} = 3.3V$		1.2		nV/V
Output Voltage	V_{OUT}	$T_A = +25^\circ C$	2.495	2.500	2.505	V
Output Voltage Temperature Coefficient	TCV_{OUT}	$C_{REF} = 2nF$ (Note 2)		2	10	ppm/ $^\circ C$
Temperature Hysteresis	$\frac{\Delta V_{REF}}{\text{Cycle}}$	$C_{REF} = 2nF$		-140		ppm
Load Regulation	$\frac{\Delta V_{REF}}{\Delta I_{OUT}}$	Sourcing $0V \leq I_{OUT} \leq 500 \mu A$		0.14	0.6	$\mu V/\mu A$
Short-Circuit Current	I_{SC}	Short to GND		3		mA
Maximum Capacitive Load	C_{REF}			2		nF
DYNAMIC						
V_{CC1} Ripple Rejection	$\frac{V_{REF}}{V_{CC1}}$	$V_{CC1} = 3.3V$, $f = 120Hz$		90		dB
V_{CC} Ripple Rejection	$\frac{V_{REF}}{V_{CC}}$	$V_{CC} = 12V$, $V_{CC1} = 3.3V$, $f = 120Hz$		160		dB
Turn-On Settling Time	t_R	From 90% of V_{CC1} to within 0.1% of V_{REF} , $C_{REF} = 2nF$		85		μs
Noise Voltage	e_{REF}	0.1Hz to 10Hz		40		μV_{p-p}
		10Hz to 10kHz		125		μV_{RMS}

Electrical Characteristics (continued)

PWM Conditioners

$V_{CCI} = +3.0V$ to $+5.5V$, $V_{GND} = 0V$, outputs connected to $100k\Omega$ in parallel with $10pF$ terminated to $V_{REF}/2$, input pulses have 10ns rise and fall times, PWM period = $100\mu s$, $T_A = T_{MIN}$ to T_{MAX} , unless otherwise noted. Typical values are at $T_A = +25^\circ C$, $V_{CCI} = +3.3V$. (Note 1)

PARAMETER	SYMBOL	CONDITIONS	MIN	TYP	MAX	UNITS
PWMA, PWMB						
STATIC						
Supply Voltage	V_{CCI}	Guaranteed by $PSRR_{VOH}$ test	3.0		5.5	V
V_{CCI} Supply Rejection Ratio of Input Threshold Voltage	$PSRR_{VTH}$	$3.0V \leq V_{CCI} \leq 5.5V$		65		dB
V_{CC} Supply Rejection Ratio of Input Threshold Voltage		$4.3V \leq V_{CC} \leq 36V$, $V_{CCI} = 3.3V$		150		dB
V_{CCI} Supply Rejection Ratio of Output Voltage High	$PSRR_{VOH}$	$3.0V \leq V_{CCI} \leq 5.5V$, no load	59	75		dB
V_{CC} Supply Rejection Ratio of Output Voltage High		$4.3V \leq V_{CC} \leq 36V$, $V_{CCI} = 3.3V$, no load		160		dB
Input Voltage Range			0		V_{CCI}	V
Input Voltage High	V_{IH}	PWMA, PWMB, \overline{SHDN}	1.4			V
Input Voltage Low	V_{IL}	PWMA, PWMB, \overline{SHDN}			0.6	V
PWMA, PWMB Input Threshold	V_{TH}			1.0		V
PWMA, PWMB Input Threshold Accuracy				1		mV
PWMA, PWMB Hysteresis	PWM_{HYS}			5		mV
SHDN Hysteresis	$SHDN_{HYS}$			50		mV
Input Bias Current	I_B	$V_{PWMA} = V_{PWMB} = 0V$		-1		nA
Input Capacitance	C_{IN}			2		pF
Output Voltage High	V_{OH}	$V_{REF} - V_{OUT}$, $I_{SOURCE} = 100\mu A$			0.1	V
Output Voltage Low	V_{OL}	$V_{OUT} - V_{GND}$, $I_{SINK} = 100\mu A$			0.1	V
Short Circuit Current	I_{SC}	PWMA or PWMB short to V_{REF}		-12		mA
		PWMA or PWMB short to GND		6		mA
Output High Level Voltage Matching		Difference between the voltage of the two PWM outputs	-2		+2	mV
Output Low Level Voltage Matching		Difference between the voltage of the two PWM outputs	-2		+2	mV
PWMA, PWMB Output Voltage High Drift				7		$\mu V/^\circ C$
Linearity		From code 10 to code 245 (Note 2), Figure 1			0.01	%FSR

Electrical Characteristics (continued)

PWM Conditioners (continued)

$V_{CCI} = +3.0V$ to $+5.5V$, $V_{GND} = 0V$, outputs connected to $100k\Omega$ in parallel with $10pF$ terminated to $V_{REF}/2$, input pulses have 10ns rise and fall times, PWM period = $100\mu s$, $T_A = T_{MIN}$ to T_{MAX} , unless otherwise noted. Typical values are at $T_A = +25^\circ C$, $V_{CCI} = +3.3V$. (Note 1)

PARAMETER	SYMBOL	CONDITIONS	MIN	TYP	MAX	UNITS
DYNAMIC						
Propagation Delay Active to Shut down	t_{SHDN}	From 50% of \overline{SHDN} to when PWM outputs are Hi-Z		10		μs
Propagation Delay Shut down to Active	t_{ACT}	From 50% of \overline{SHDN} to when PWM outputs are active		10		μs
Minimum Input Pulse Width	I_{PW}	Single high state, guaranteed by PWM timing tests	390			ns
Driver Rise Time for PWMAO and PWMBO	R_{TA}, R_{TB}	Single 390ns pulse, 10% to 90%			7	ns
Driver Fall Time for PWMAO and PWMBO	F_{TA}, F_{TB}				6	ns
PWMAO to PWMBO Rise Time Matching		Single 390ns pulse	-4		+4	ns
PWMAO to PWMBO Fall Time Matching		Single 390ns pulse	-2		+2	ns
PWMAO to PWMBO Delay Matching		Single 390ns pulse, measured at 50% FSR of rising edges	-30		+30	ns
PWMAO and PWMBO Pulse Width Accuracy		Single 390ns pulse, pulse width difference between input and output waveforms (measured at 50% points)	-30		+30	ns
PWMAO and PWMBO Pulse Width Variation vs. Temperature		Single 390ns pulse		25		ps/ $^\circ C$
PWMAO and PWMBO Pulse Width Matching		Single 390ns pulse, difference between PWMAO and PWMBO pulse widths	-30		+30	ns

Electrical Characteristics (continued)

Op Amps

$V_{CCI} = +3.0V$ to $+5.5V$, $V_{GND} = 0V$, $V_{CM} = V_{OUT} = V_{CCI}/2$, no resistive load, $C_L = 10pF$, $T_A = T_{MIN}$ to T_{MAX} , unless otherwise noted. Typical values are at $T_A = +25^\circ C$, $V_{CCI} = +3.3V$. (Note 1)

PARAMETER	SYMBOL	CONDITIONS	MIN	TYP	MAX	UNITS
OP1, OP2						
STATIC						
Supply Voltage	V_{CCI}	Guaranteed by $PSRR_{V_{CCI}}$ test	3.0		5.5	V
V_{CCI} Supply Rejection Ratio	$PSRR_{V_{CCI}}$	$3.0V \leq V_{CCI} \leq 5.5V$	62	80		dB
V_{CC} Supply Rejection Ratio	$PSRR_{V_{CC}}$	$4.3V \leq V_{CC} \leq 36V$, $V_{CCI} = 3.3V$		165		dB
Common Mode Input Voltage	V_{CMR}	Guaranteed by CMRR test $V_{CCI} \leq 4.5V$	-0.1		$V_{CCI} - 0.5$	V
		Guaranteed by CMRR test $4.5V \leq V_{CCI} \leq 5.5V$	-0.1		+4.0	V
Common Mode Rejection Ratio	CMRR	$-0.1V \leq V_{CM} \leq \min(4.0V, V_{CCI} - 0.5V)$	56			dB
Input Offset Voltage	V_{OS}			1		mV
Input Offset Voltage Drift	ΔV_{OS}	(Note 2)			15	$\mu V/^\circ C$
Input Bias Current	I_B	$-40^\circ C \leq T_A \leq +85^\circ C$ (Note 2)	-15		+15	pA
		$-40^\circ C \leq T_A \leq +125^\circ C$ (Note 2)	-125		+125	pA
Input Offset Current	I_{OS}	$-40^\circ C \leq T_A \leq +85^\circ C$ (Note 2)	-15		+15	pA
		$-40^\circ C \leq T_A \leq +125^\circ C$ (Note 2)	-80		+80	pA
Open-Loop Gain	AVOL	$150mV \leq V_{OUT} \leq V_{CCI} - 150mV$, $R_L = 100k\Omega$ connected to $V_{CCI} / 2$, $-40^\circ C \leq T_A \leq +85^\circ C$	78			dB
		$-40^\circ C \leq T_A \leq +125^\circ C$	72			
Output Voltage High	V_{OH}	$V_{CCI} - V_{OUT}$, $R_L = 100k\Omega$ connected to $V_{CCI} / 2$			25	mV
Output Voltage Low	V_{OL}	$V_{OUT} - V_{GND}$, $R_L = 100k\Omega$ connected to $V_{CCI} / 2$			25	mV
Output Short-Circuit Current	$I_{OUT(SC)}$			± 3		mA

Electrical Characteristics (continued)

Op Amps (continued)

$V_{CCI} = +3.0V$ to $+5.5V$, $V_{GND} = 0V$, $V_{CM} = V_{OUT} = V_{CCI}/2$, no resistive load, $C_L = 10pF$, $T_A = T_{MIN}$ to T_{MAX} , unless otherwise noted. Typical values are at $T_A = +25^\circ C$, $V_{CCI} = +3.3V$. (Note 1)

PARAMETER	SYMBOL	CONDITIONS	MIN	TYP	MAX	UNITS
DYNAMIC						
Input Voltage Noise Density	eN	f = 1kHz		150		nV/ \sqrt{Hz}
Input Current Noise Density	iN	f = 1kHz		40		fA/ \sqrt{Hz}
Gain Bandwidth Product	GBWP			200		kHz
Slew Rate	SR			0.1		V/ μs
Settling Time		To 0.1%, $V_{OUT} = 2V$ step, $A_V = -1V/V$		25		μs
Maximum Capacitive Load	C_L	No sustained oscillations, $A_V = 1V/V$		100		pF
OP3 ($R_L = 100k\Omega$ CONNECTED to $V_{CCI}/2$, $C_L = 20pF$)						
STATIC						
Supply Voltage	V_{CCI}	Guaranteed by PSRR $_{V_{CCI}}$ test	3.0		5.5	V
V_{CCI} Supply Rejection Ratio	PSRR $_{V_{CCI}}$	$3.0V \leq V_{CCI} \leq 5.5V$	107			dB
V_{CC} Supply Rejection Ratio	PSRR $_{V_{CC}}$	$4.3V \leq V_{CC} \leq 36V$, $V_{CCI} = 3.3V$		195		dB
Common Mode Input Voltage	V_{CMR}	Guaranteed by CMRR test $V_{CCI} \leq 4.3V$	-0.1		$V_{CCI} - 0.3$	V
		Guaranteed by CMRR test $4.3V < V_{CCI} \leq 5.5V$	-0.1		+4.0	V
Common Mode Rejection Ratio	CMRR	$-0.1V \leq V_{CM} \leq \min(4.0V, V_{CCI} - 0.3V)$	105			dB
Input Offset Voltage	V_{OS}	$T_A = 25^\circ C$, $V_{CCI} = 3.3V$ (Note 2)	-10		+10	μV
Input Offset Voltage Drift	ΔV_{OS}	(Note 2)		5	70	nV/ $^\circ C$
Input Bias Current	I_B	$-40^\circ C \leq T_A \leq +85^\circ C$ (Note 2)	-15		+15	pA
		$-40^\circ C \leq T_A \leq +125^\circ C$ (Note 2)	-125		+125	pA
Input Offset Current	I_{OS}			-40		pA
Input Capacitance	C_{IN}			2		pF
Open-Loop Gain	AVOL	$150mV \leq V_{OUT} \leq V_{CCI} - 150mV$, $R_L = 5k\Omega$ connected to $V_{CCI} / 2$	123	150		dB
Output Voltage High	V_{OH}	$V_{CCI} - V_{OUT}$, $R_L = 100k\Omega$ connected to $V_{CCI} / 2$			12	mV
Output Voltage Low	V_{OL}	$V_{OUT} - V_{GND}$, $R_L = 100k\Omega$ connected to $V_{CCI} / 2$			12	mV

Electrical Characteristics (continued)

Op Amps (continued)

$V_{CCI} = +3.0V$ to $+5.5V$, $V_{GND} = 0V$, $V_{CM} = V_{OUT} = V_{CCI}/2$, no resistive load, $C_L = 10pF$, $T_A = T_{MIN}$ to T_{MAX} , unless otherwise noted. Typical values are at $T_A = +25^\circ C$, $V_{CCI} = +3.3V$. (Note 1)

PARAMETER	SYMBOL	CONDITIONS	MIN	TYP	MAX	UNITS
DYNAMIC						
Input Voltage Noise Density	eN	f = 1kHz		35		nV/ \sqrt{Hz}
Input Voltage Noise		0.1Hz \leq f \leq 10Hz		0.7		μV_{p-p}
Input Current Noise Density	iN	f = 1kHz		80		fA/ \sqrt{Hz}
Gain Bandwidth Product	GBWP			2.2		MHz
Slew Rate	SR			0.7		V/ μs
Phase Margin				57		$^\circ$
Maximum Capacitive Load	C_L	No sustained oscillations, $A_V = 1V/V$		300		pF

Electrical Characteristics (continued)

Comparators

$V_{CCI} = +3.0V$ to $+5.5V$, $V_{DD} = +1.8V$ to $+3.6V$, $V_{GND} = 0V$, $V_{CM} = 0V$, $T_A = T_{MIN}$ to T_{MAX} , unless otherwise noted. Typical values are at $T_A = +25^\circ C$, $V_{DD} = V_{CCI} = +3.3V$. (Note 1)

PARAMETER	SYMBOL	CONDITIONS	MIN	TYP	MAX	UNITS
COMP1, COMP2						
STATIC						
Supply Voltage	V_{CCI}	Guaranteed by PSRR $_{V_{CCI}}$ test	3.0		5.5	V
Supply Voltage Output Stage	V_{DD}		1.8		3.6	V
V_{CCI} Supply Rejection Ratio	PSRR $_{V_{CCI}}$	$3.0V \leq V_{CCI} \leq 5.5V$	54			dB
V_{CC} Supply Rejection Ratio	PSRR $_{V_{CC}}$	$4.3V \leq V_{CC} \leq 36V$, $V_{CCI} = 3.3V$		160		dB
Common Mode Input Voltage	V_{CMR}	Guaranteed by CMRR test	0		$V_{CCI} - 1.3$	V
Common Mode Rejection Ratio	CMRR	$0V \leq V_{CM} \leq V_{CCI} - 1.3V$	56	75		dB
Input Offset Voltage	V_{OS}		-10		+10	mV
Hysteresis	V_{HYS}			15		mV
Input Bias Current	I_B	$V_{CM} = 0V$	-10	-1		nA
Input Offset Current	I_{OS}			1		nA
Input Capacitance	C_{IN}			2		pF
Output Voltage High	V_{OH}	$V_{DD} - V_{OUT}$, $I_{SOURCE} = 100 \mu A$			0.4	V

Electrical Characteristics (continued)

Comparators (continued)

$V_{CCI} = +3.0V$ to $+5.5V$, $V_{DD} = +1.8V$ to $+3.6V$, $V_{GND} = 0V$, $V_{CM} = 0V$, $T_A = T_{MIN}$ to T_{MAX} , unless otherwise noted. Typical values are at $T_A = +25^\circ C$, $V_{DD} = V_{CCI} = +3.3V$. (Note 1)

PARAMETER	SYMBOL	CONDITIONS	MIN	TYP	MAX	UNITS
Output Voltage Low	V_{OL}	$V_{OUT} - V_{GND}$, $I_{SINK} = 100 \mu A$			0.4	V
Short Circuit Current	I_{SC}	Short to GND		2		mA
		Short to V_{DD}		-2		mA
DYNAMIC						
Propagation Delay Low to High	t_{PD+}	$C_{LOAD} = 10pF$, threshold set to $V_{CCI} - 1.4V$, input swings from $0V$ to $V_{CCI} - 1.3V$		2		μs
Propagation Delay High to Low	t_{PD-}	$C_{LOAD} = 10pF$, threshold set to $0.1V$, input swings from $V_{CCI} - 1.3V$ to $0V$		0.5		μs
Rise Time	T_R	$C_{LOAD} = 10pF$		50		ns
Fall Time	T_F	$C_{LOAD} = 10pF$		50		ns

LDO

$V_{CC} = +4.0V$ to $+36V$, $V_{GND} = 0V$, $C_{LOAD} = 0.32\mu F$, $T_A = T_{MIN}$ to T_{MAX} , unless otherwise noted. Typical values are at $T_A = +25^\circ C$, $V_{CC} = +24V$. (Note 1)

PARAMETER	SYMBOL	CONDITIONS	MIN	TYP	MAX	UNITS
LDO						
STATIC						
Supply Voltage	V_{CC}	Guaranteed by line regulation test	4.0	24	36	V
Dropout Voltage		Guaranteed by line and load regulation tests	1			V
V_{CC} Line Regulation		V_{CC} from $V_{CCI} + 1V$ to $36V$, $I_{LDO} = 4mA$, $V_{CCI} = 3.0V$ to $5.5V$		2	25	mV
Output Voltage	V_{CCI}	Guaranteed by block PSRR $_{V_{CCI}}$ tests	3.0		5.5	V
Output Voltage Accuracy		$V_{CC} = 24V$, no load except for LDOFB resistor divider, $V_{CCI} = 3.3V$	-3.5		+3.5	%
Output Current Range	I_{LDO}	Guaranteed by load regulation test	0		4	mA
V_{CCI} Current Limit	I_{CCI_Limit}	V_{CCI} short to GND		12		mA
Load Regulation		$V_{CC} = V_{CCI} + 1V$, I_{LDO} from $0mA$ to $4mA$, $V_{CCI} = 3.0V$ to $5.5V$		1	10	mV
Maximum Capacitive Load	C_{LOAD}	No resistive load except for LDOFB resistor divider		5		μF
DYNAMIC						
V_{CC} Supply Rejection Ratio	PSRR	$V_{CC} = 12V$, DC to $120Hz$		70		dB

Electrical Characteristics (continued)

Chip-Level Specifications

$V_{CC} = +4.0V$ to $+36V$, $V_{CCI} = +3.0V$ to $+5.5V$, $V_{DD} = +1.8V$ to $+3.6V$, $V_{GND} = 0V$, $T_A = T_{MIN}$ to T_{MAX} , unless otherwise noted. Typical values are at $T_A = +25^{\circ}C$, $V_{CC} = +24V$, $V_{DD} = V_{CCI} = +3.3V$. (Note 1)

PARAMETER	SYMBOL	CONDITIONS	MIN	TYP	MAX	UNITS
STATIC						
V _{CC} Supply Current	I _{CC}	V _{CC} = 24V, V _{CCI} = 3.3V, $\overline{SHDN} = 3.3V$, no load, $-40^{\circ}C \leq T_A \leq +85^{\circ}C$		170	250	μA
		$-40^{\circ}C \leq T_A \leq +125^{\circ}C$			265	μA
V _{CC} Supply Current with PWM Conditioners Shutdown	I _{CC_SHDN}	V _{CC} = 24V, V _{CCI} = 3.3V, $\overline{SHDN} = 0V$, no load		142		μA
V _{DD} Supply Current	I _{DD}				1	μA
PWRGOOD Turn-on Threshold				90		% of V _{CCI}
PWRGOOD Turn-off Threshold				80		% of V _{CCI}
PWRGOOD Voltage High	V _{OH}	V _{CCI} - V _{OUT} , I _{SOURCE} = 100 μA			0.4	V
PWRGOOD Voltage Low	V _{OL}	V _{OUT} - V _{GND} , I _{SINK} = 100 μA			0.4	V
PWRGOOD Short Circuit Current	I _{SC}	Short to GND		2		mA
		Short to V _{CCI}		-2		mA
DYNAMIC						
PWRGOOD Turn-on Delay		From V _{CCI} crossing turn-on threshold to PWRGOOD high		0.7		ms

Note 1: Specifications are 100% tested at $T_A = +25^{\circ}C$ (exceptions noted). All temperature limits are guaranteed by design.

Note 2: Guaranteed by design, not production tested.

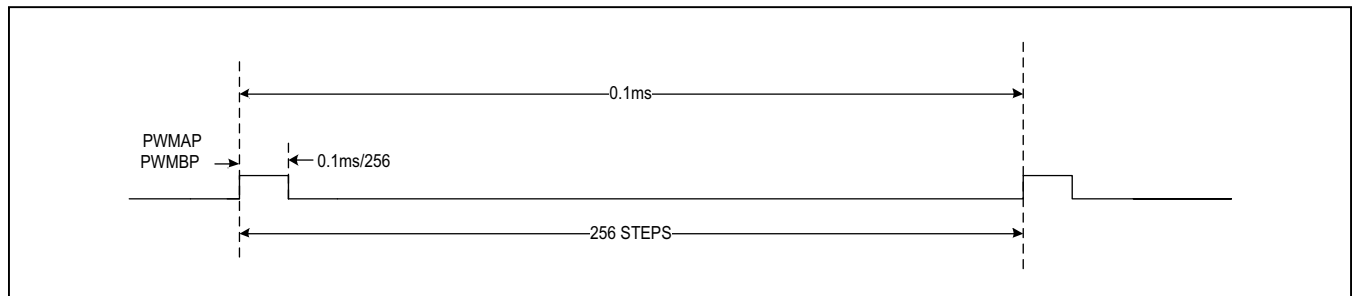
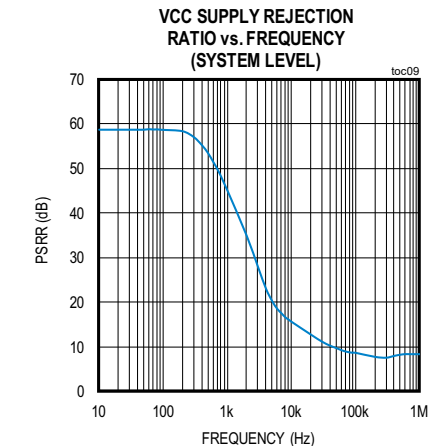
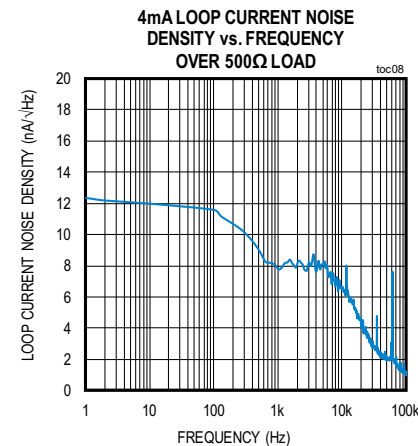
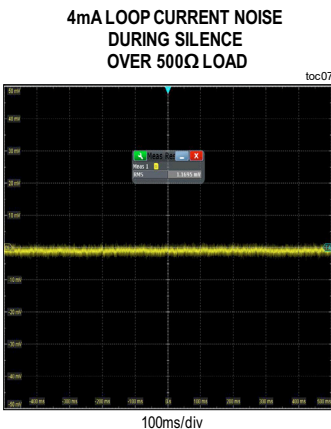
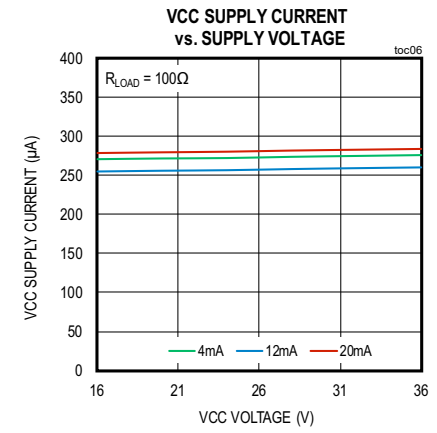
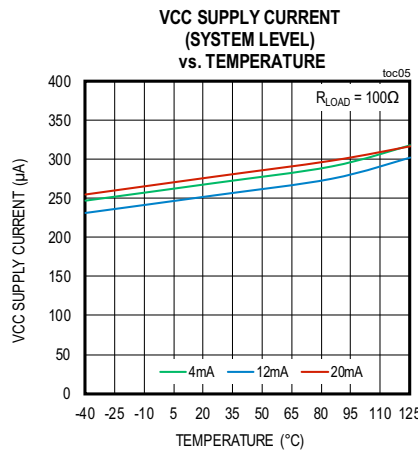
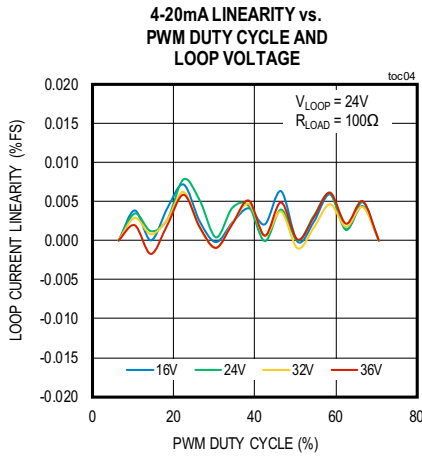
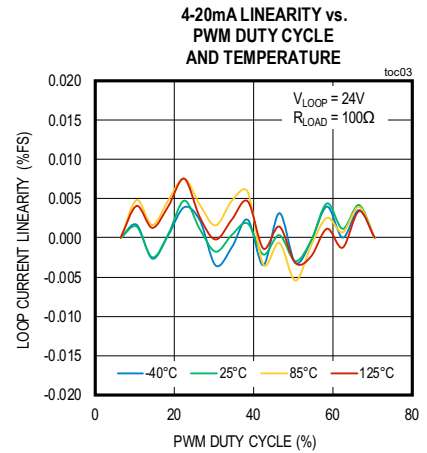
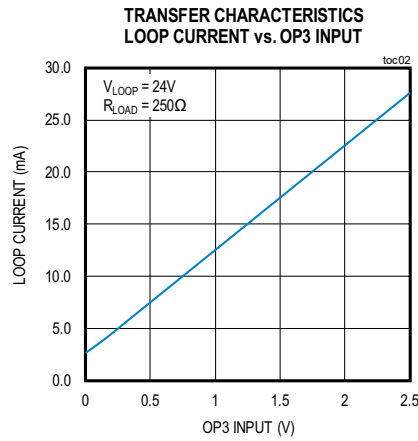
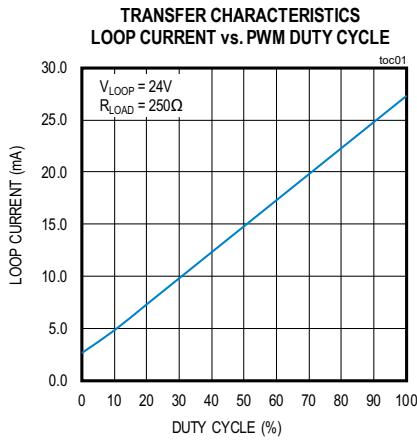

Figure 1. Typical PWM Timing Diagram

Typical Operating Characteristics

$V_{CC} = +24V$, $V_{DD} = V_{CCID} = V_{CCI} = +3.3V$, $GND = 0V$, op amp $V_{CM} = V_{OUT} = V_{CCI}/2$, op amp $C_L = 15pF$, comparator and PWM $C_L = 10pF$, LDO $C_{LOAD} = 0.32\mu F$, no resistive load on any output, $T_A = +25^\circ C$, unless otherwise noted.



Typical Operating Characteristics (continued)

$V_{CC} = +24V$, $V_{DD} = V_{CCID} = V_{CCI} = +3.3V$, $GND = 0V$, op amp $V_{CM} = V_{OUT} = V_{CCI}/2$, op amp $C_L = 15pF$, comparator and PWM $C_L = 10pF$, LDO $C_{LOAD} = 0.32\mu F$, no resistive load on any output, $T_A = +25^\circ C$, unless otherwise noted.

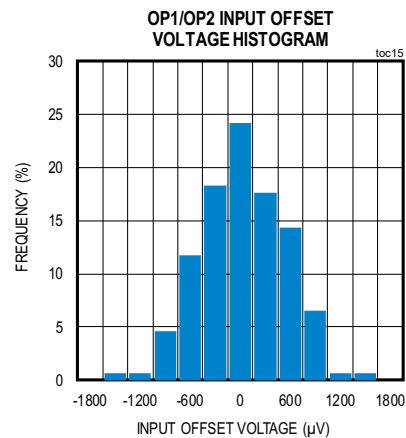
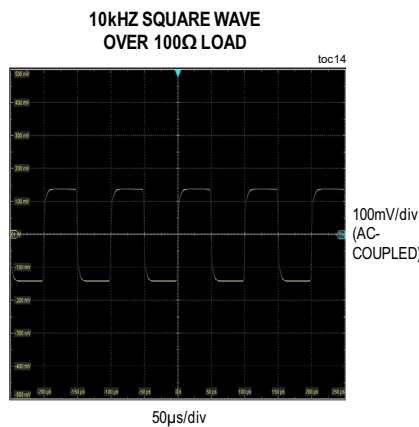
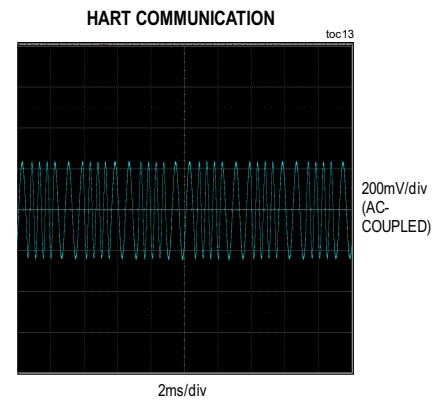
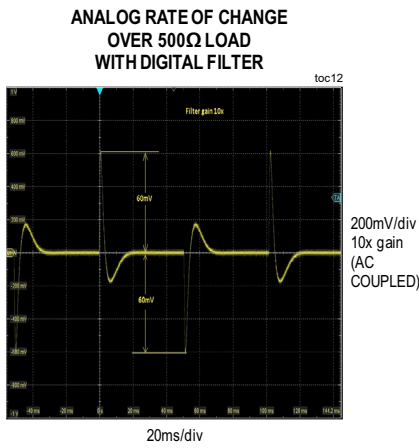
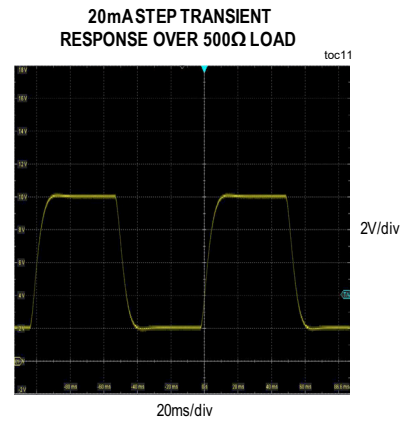
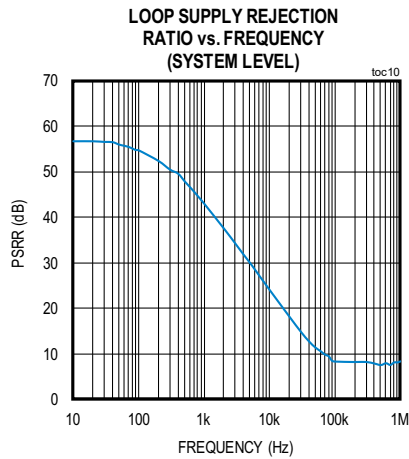

Typical Operating Characteristics (continued)

$V_{CC} = +24V$, $V_{DD} = V_{CCID} = V_{CCI} = +3.3V$, $GND = 0V$, op amp $V_{CM} = V_{OUT} = V_{CCI}/2$, op amp $C_L = 15pF$, comparator and PWM $C_L = 10pF$, LDO $C_{LOAD} = 0.32\mu F$, no resistive load on any output, $T_A = +25^\circ C$, unless otherwise noted.

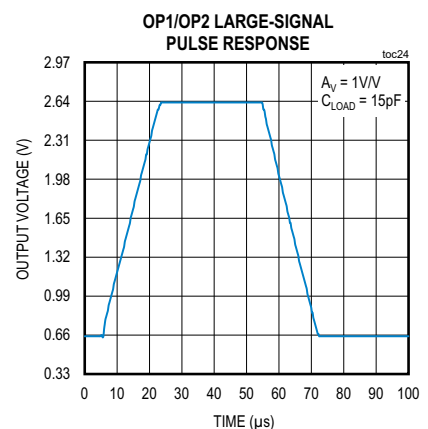
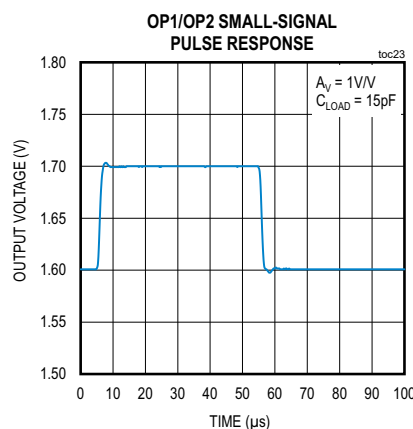
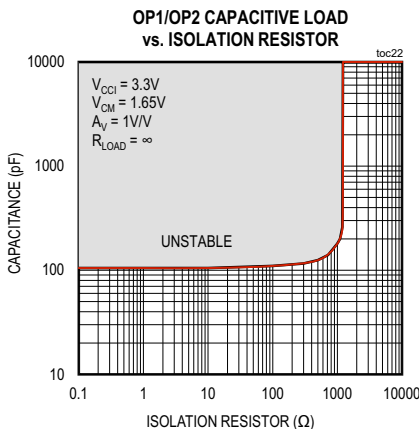
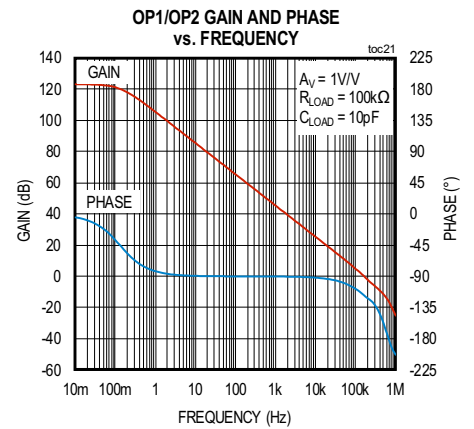
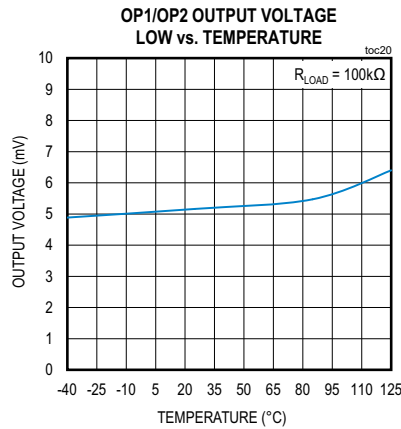
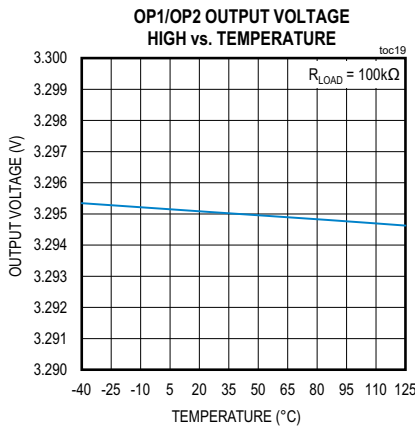
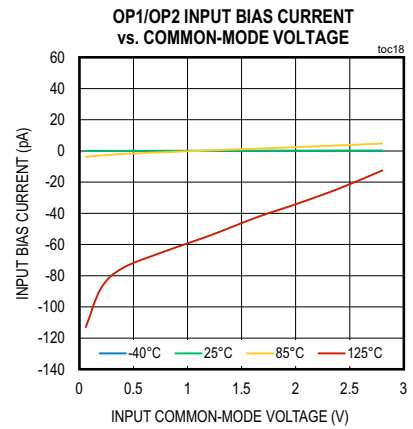
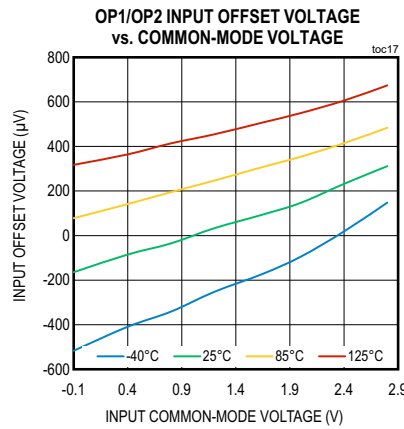
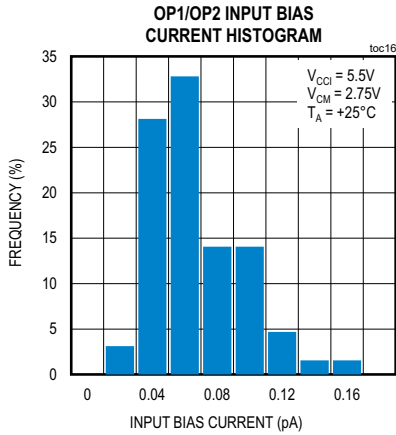

Typical Operating Characteristics (continued)

$V_{CC} = +24V$, $V_{DD} = V_{CCID} = V_{CCI} = +3.3V$, $GND = 0V$, op amp $V_{CM} = V_{OUT} = V_{CCI}/2$, op amp $C_L = 15pF$, comparator and PWM $C_L = 10pF$, LDO $C_{LOAD} = 0.32\mu F$, no resistive load on any output, $T_A = +25^\circ C$, unless otherwise noted.

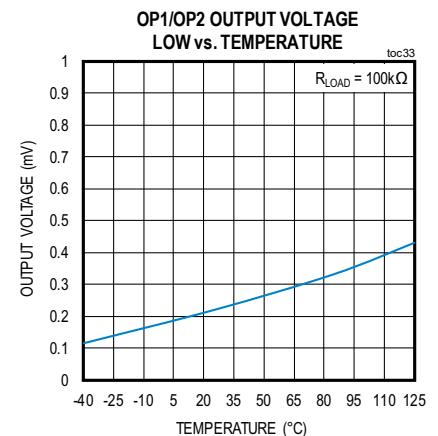
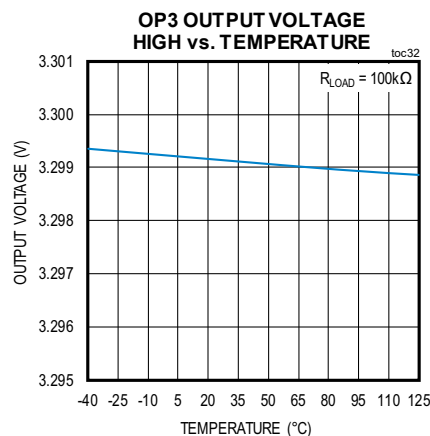
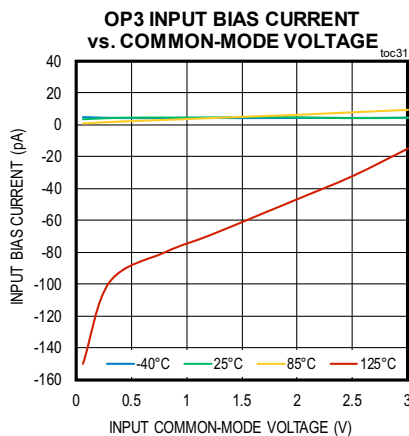
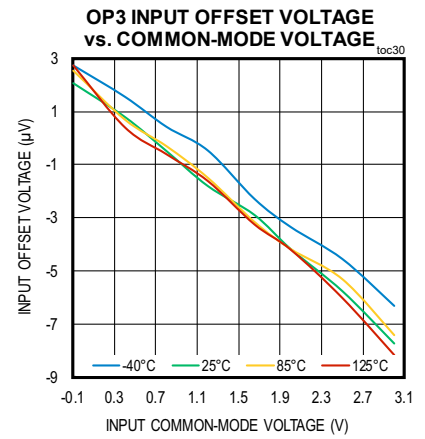
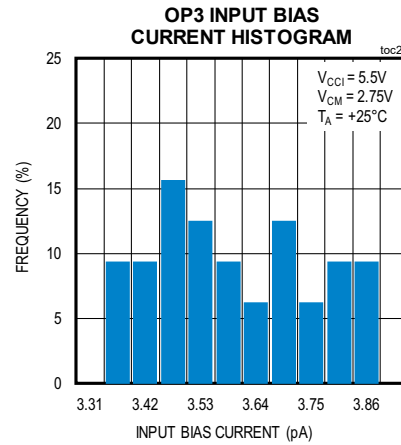
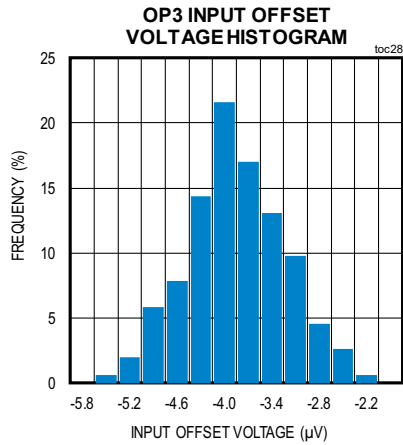
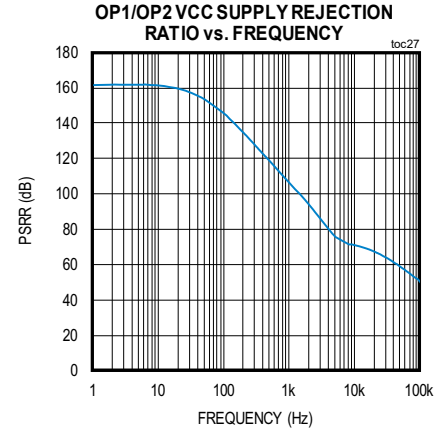
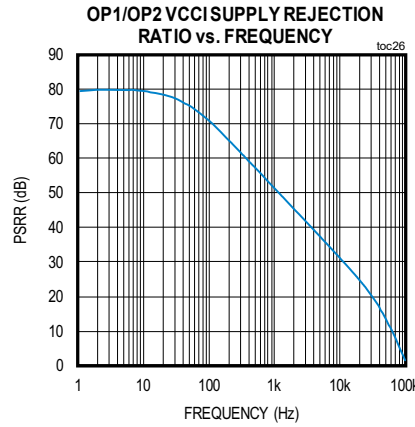
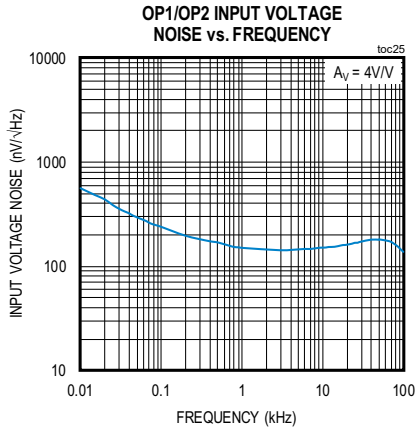

Typical Operating Characteristics (continued)

$V_{CC} = +24V$, $V_{DD} = V_{CCID} = V_{CCI} = +3.3V$, $GND = 0V$, op amp $V_{CM} = V_{OUT} = V_{CCI}/2$, op amp $C_L = 15pF$, comparator and PWM $C_L = 10pF$, LDO $C_{LOAD} = 0.32\mu F$, no resistive load on any output, $T_A = +25^\circ C$, unless otherwise noted.

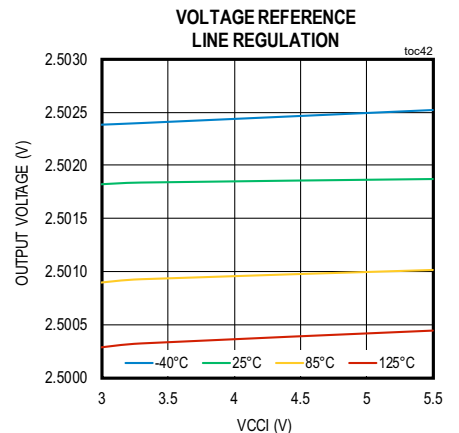
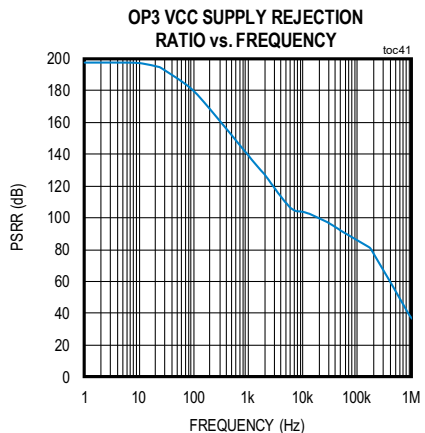
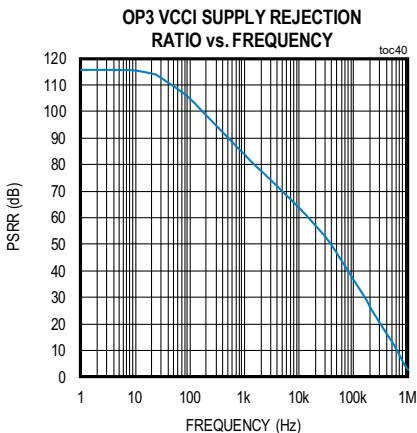
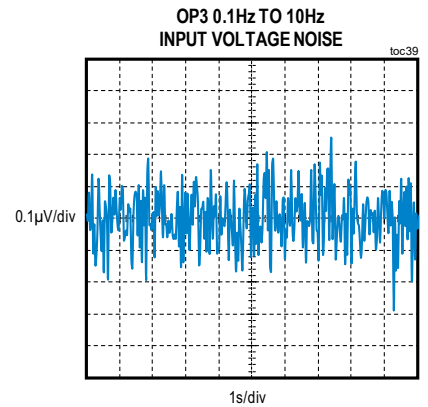
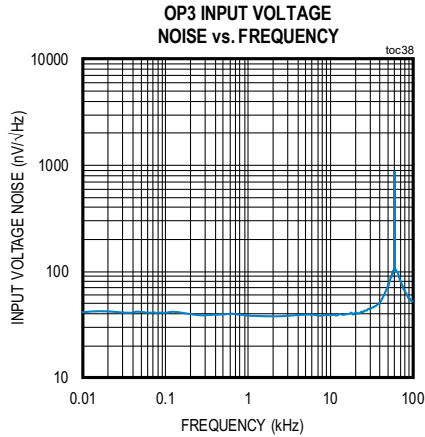
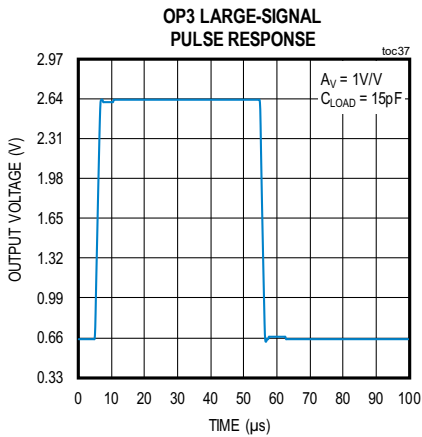
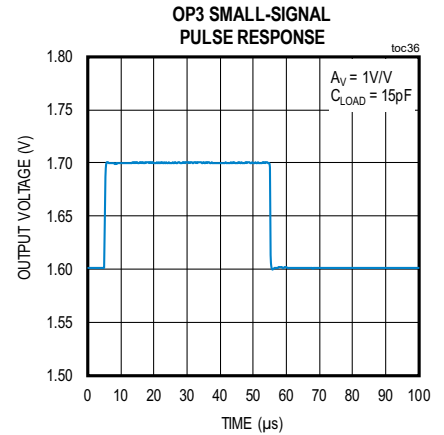
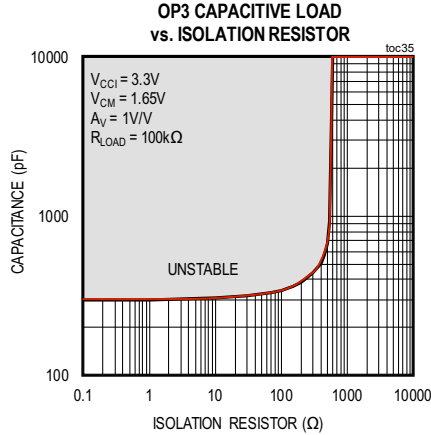
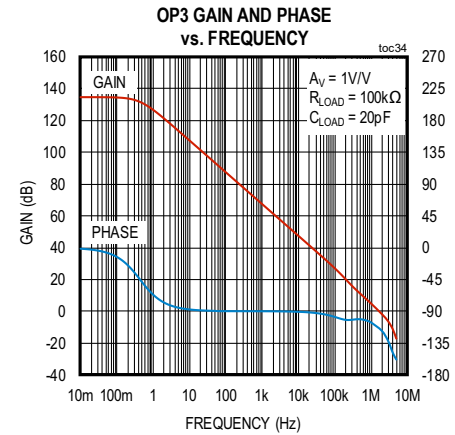

Typical Operating Characteristics (continued)

$V_{CC} = +24V$, $V_{DD} = V_{CCID} = V_{CCI} = +3.3V$, $GND = 0V$, op amp $V_{CM} = V_{OUT} = V_{CCI}/2$, op amp $C_L = 15pF$, comparator and PWM $C_L = 10pF$, LDO $C_{LOAD} = 0.32\mu F$, no resistive load on any output, $T_A = +25^\circ C$, unless otherwise noted.

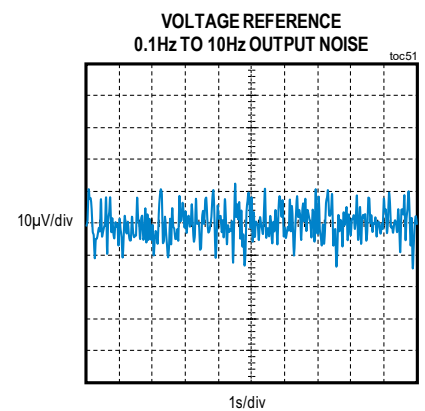
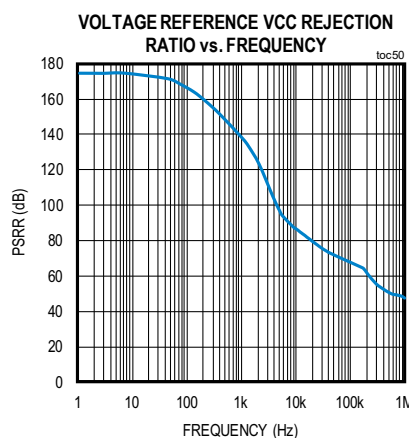
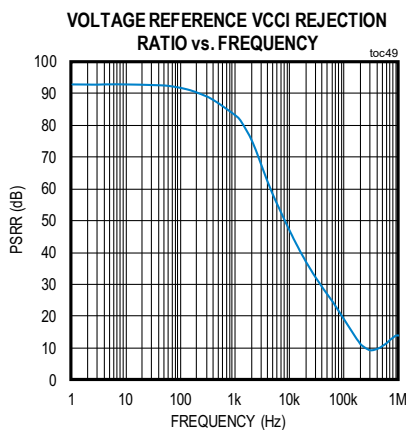
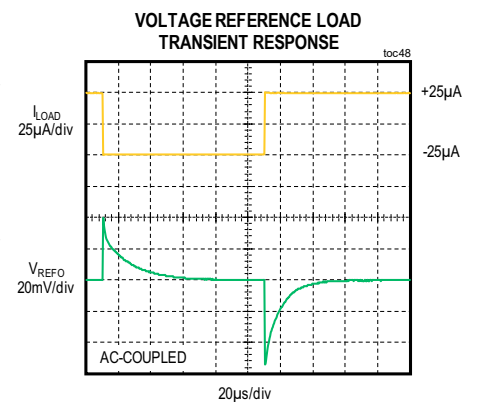
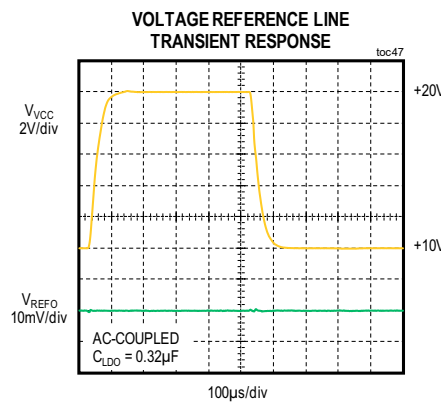
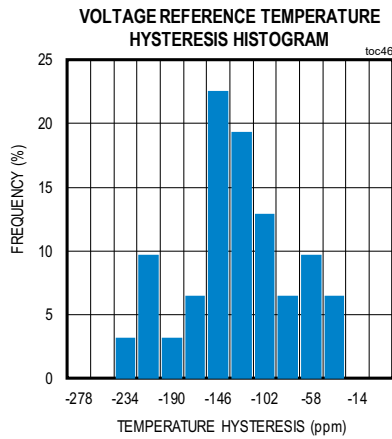
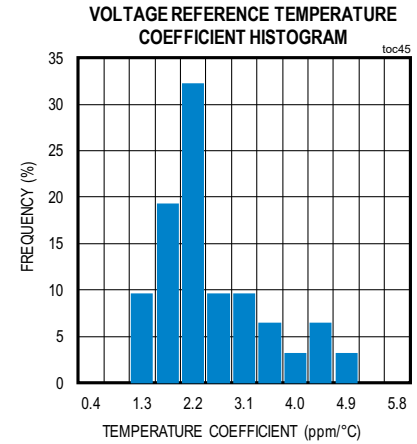
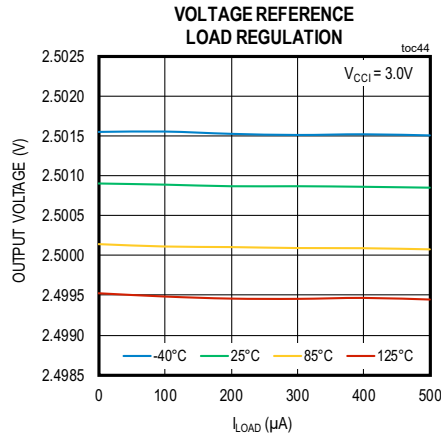
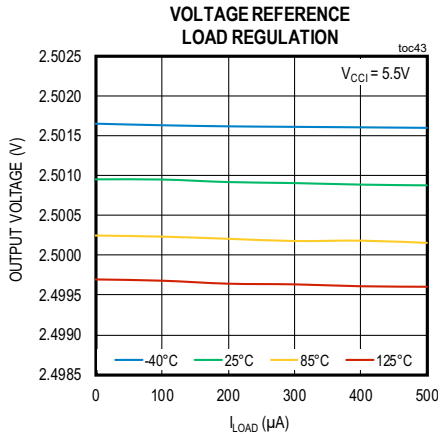

Typical Operating Characteristics (continued)

$V_{CC} = +24V$, $V_{DD} = V_{CCID} = V_{CCI} = +3.3V$, $GND = 0V$, op amp $V_{CM} = V_{OUT} = V_{CCI}/2$, op amp $C_L = 15pF$, comparator and PWM $C_L = 10pF$, LDO $C_{LOAD} = 0.32\mu F$, no resistive load on any output, $T_A = +25^\circ C$, unless otherwise noted.

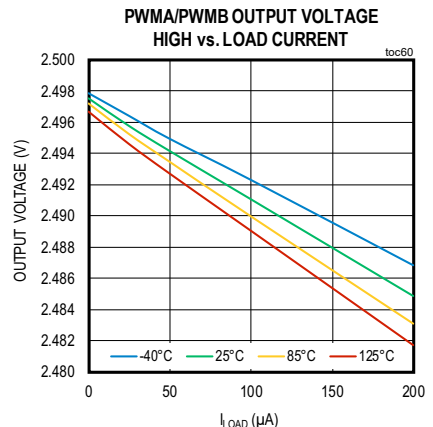
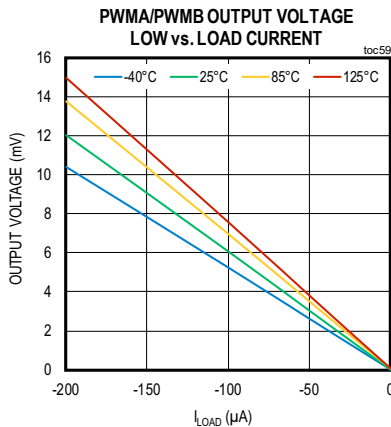
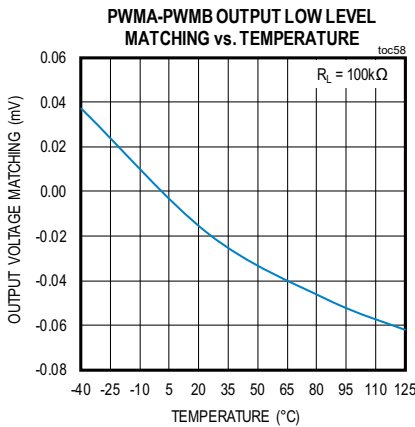
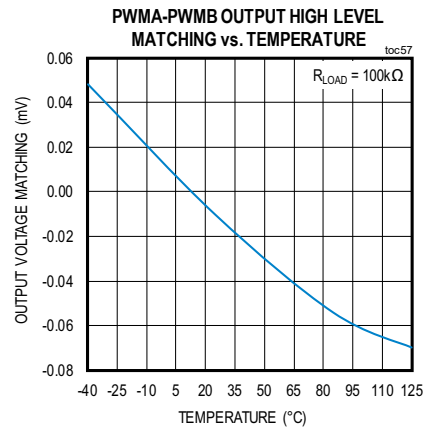
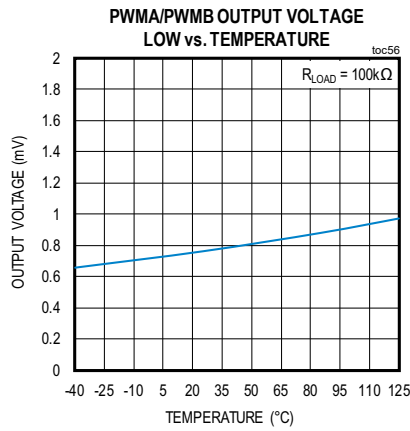
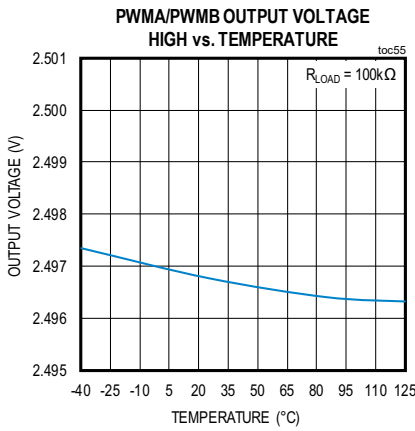
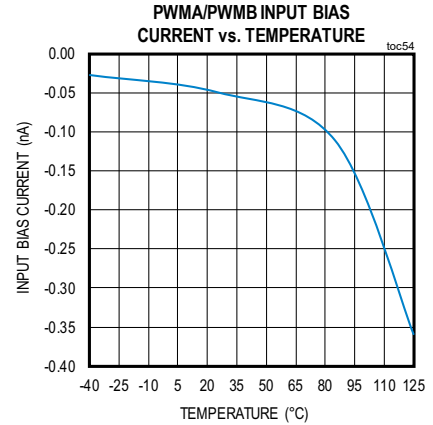
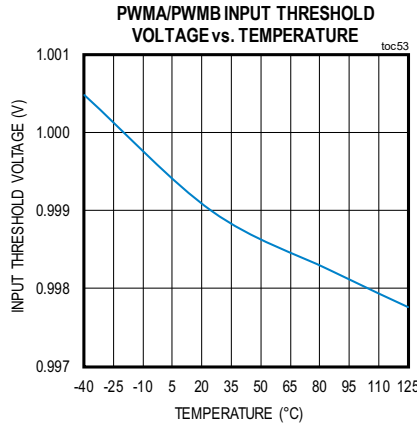
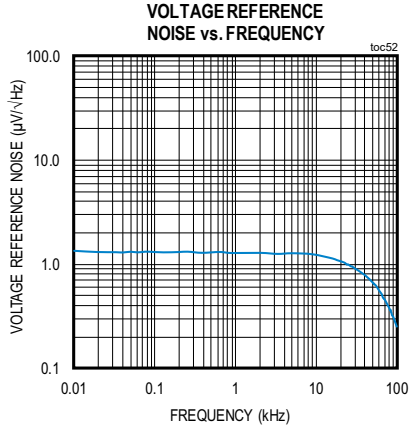

Typical Operating Characteristics (continued)

$V_{CC} = +24V$, $V_{DD} = V_{CCID} = V_{CCI} = +3.3V$, $GND = 0V$, op amp $V_{CM} = V_{OUT} = V_{CCI}/2$, op amp $C_L = 15pF$, comparator and PWM $C_L = 10pF$, LDO $C_{LOAD} = 0.32\mu F$, no resistive load on any output, $T_A = +25^\circ C$, unless otherwise noted.

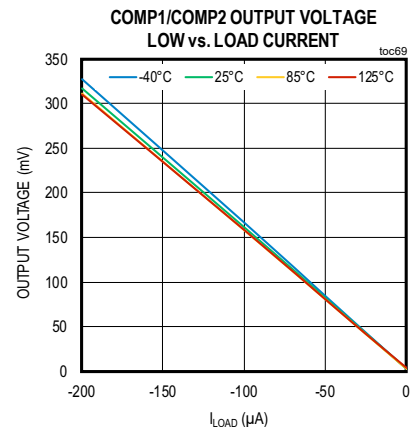
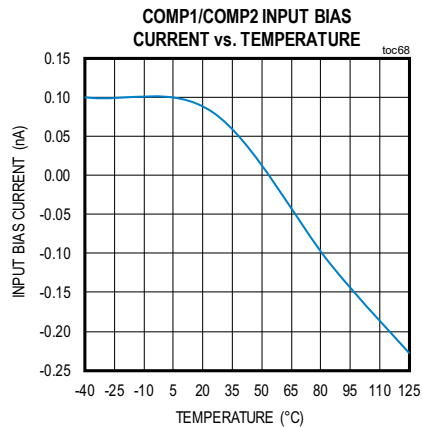
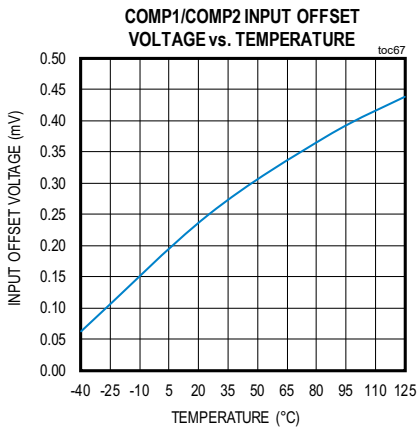
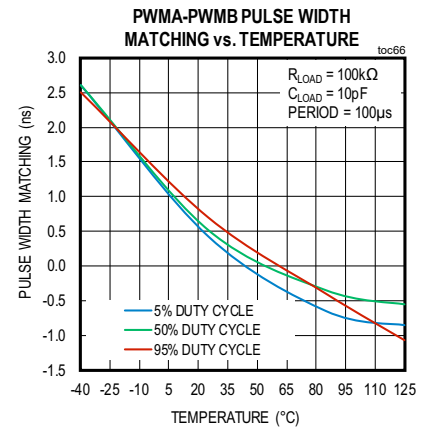
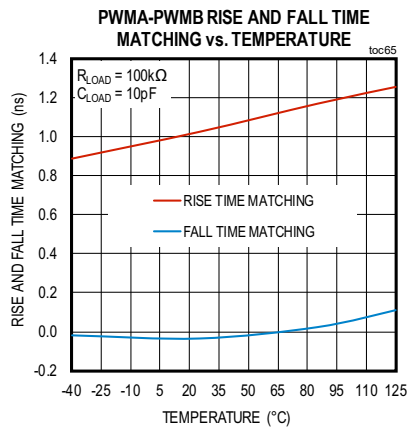
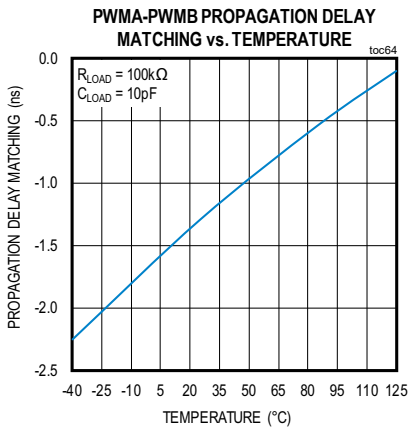
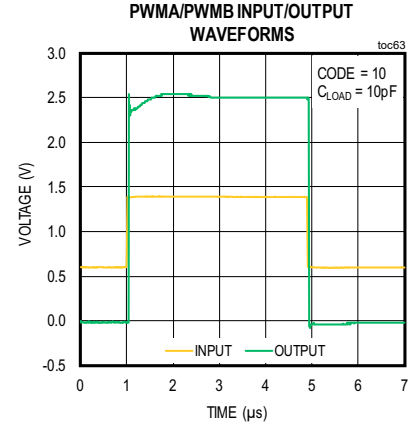
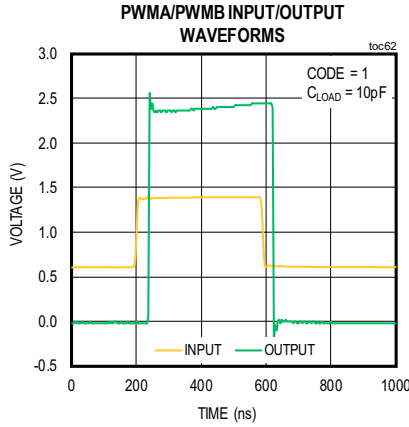
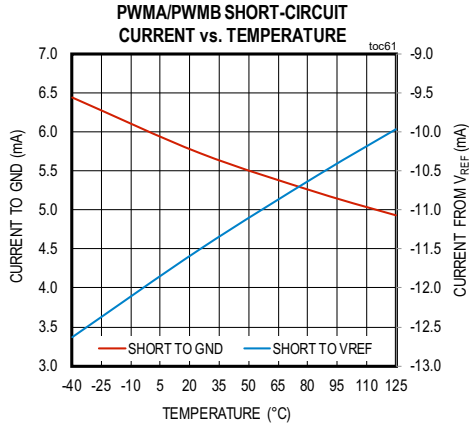

Typical Operating Characteristics (continued)

$V_{CC} = +24V$, $V_{DD} = V_{CCID} = V_{CCI} = +3.3V$, $GND = 0V$, op amp $V_{CM} = V_{OUT} = V_{CCI}/2$, op amp $C_L = 15pF$, comparator and PWM $C_L = 10pF$, LDO $C_{LOAD} = 0.32\mu F$, no resistive load on any output, $T_A = +25^\circ C$, unless otherwise noted.

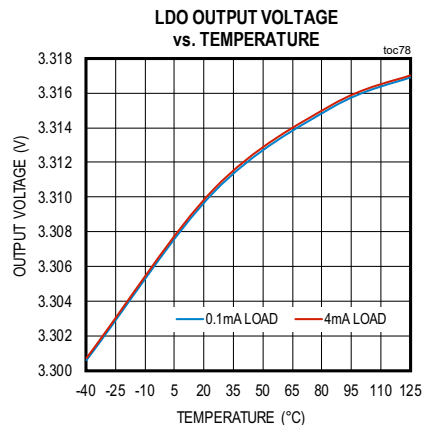
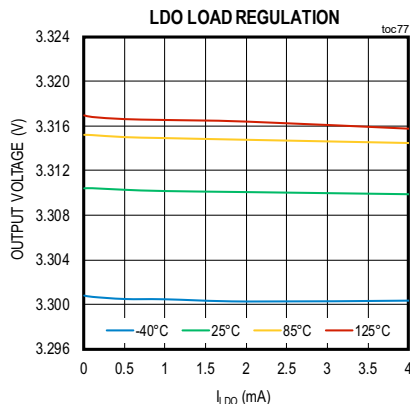
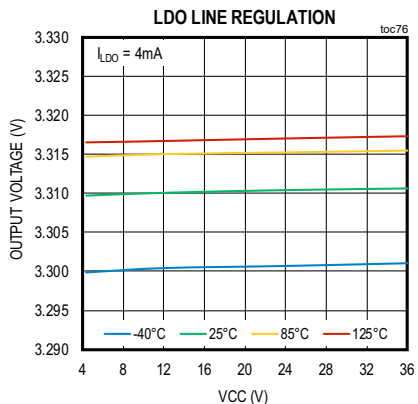
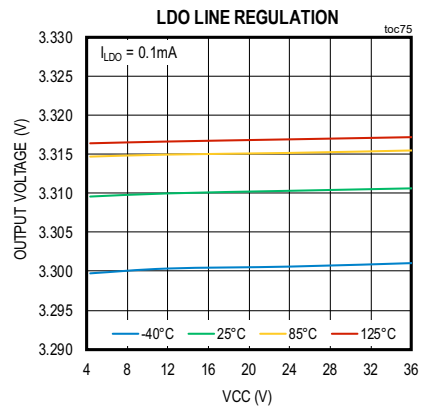
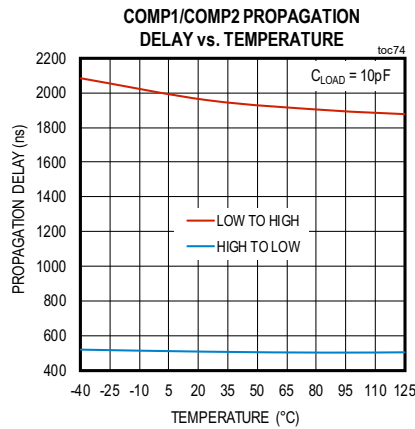
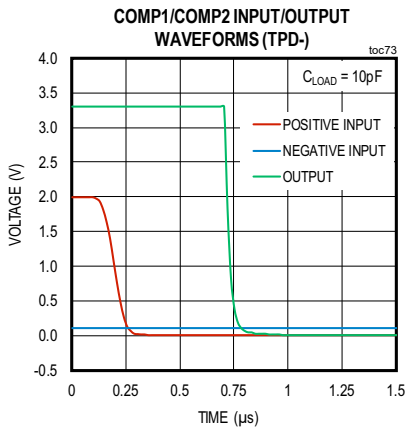
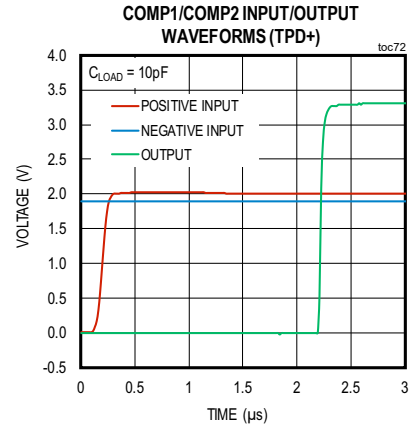
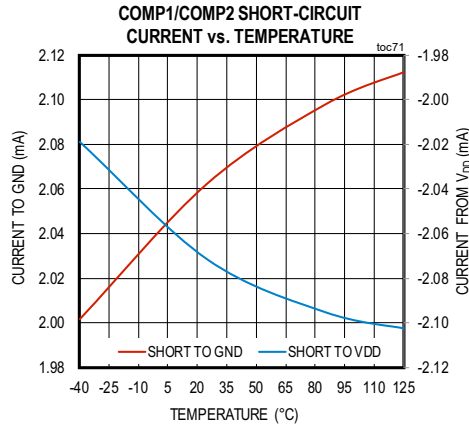
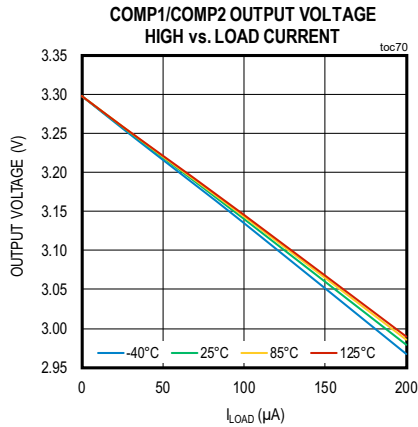

Typical Operating Characteristics (continued)

$V_{CC} = +24V$, $V_{DD} = V_{CCID} = V_{CCI} = +3.3V$, $GND = 0V$, op amp $V_{CM} = V_{OUT} = V_{CCI}/2$, op amp $C_L = 15pF$, comparator and PWM $C_L = 10pF$, LDO $C_{LOAD} = 0.32\mu F$, no resistive load on any output, $T_A = +25^\circ C$, unless otherwise noted.

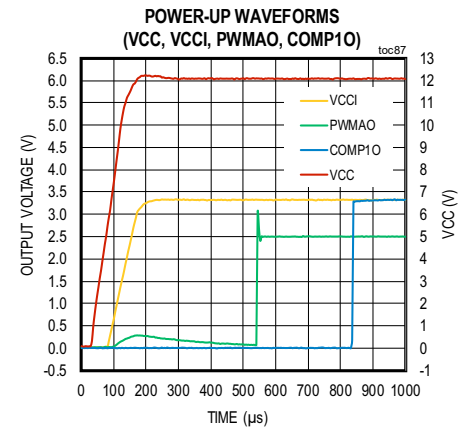
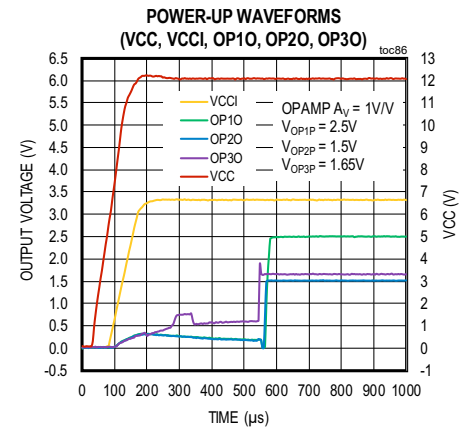
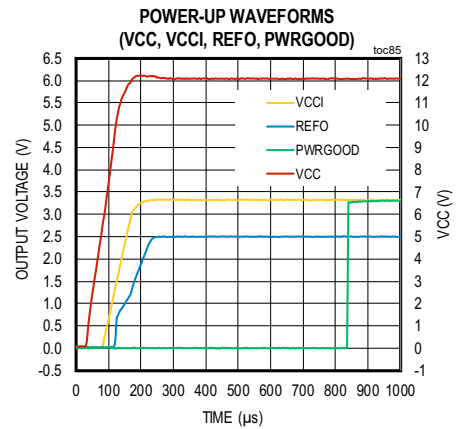
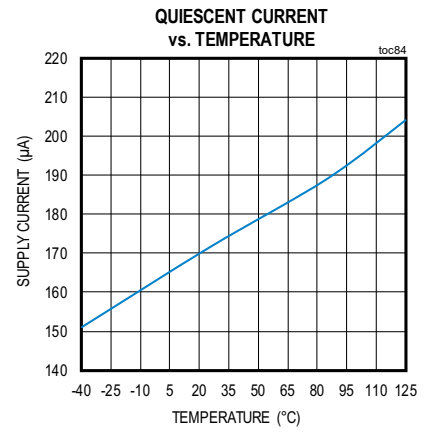
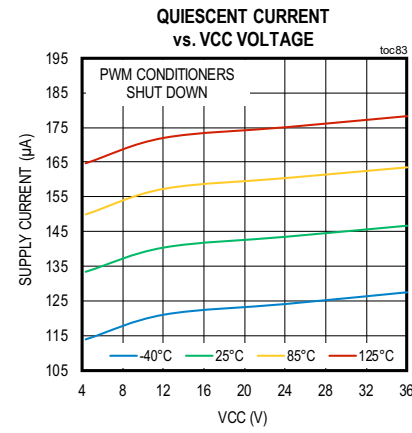
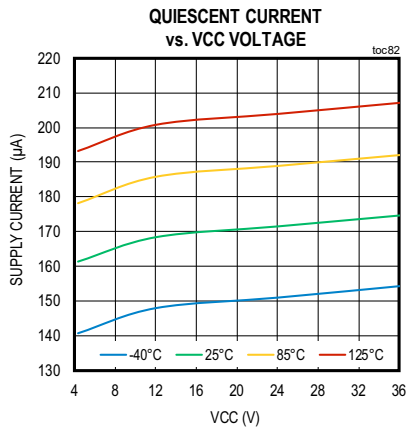
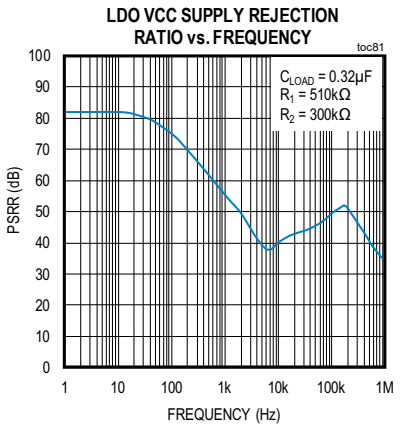
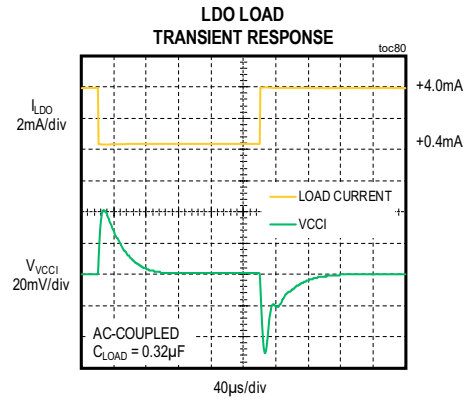
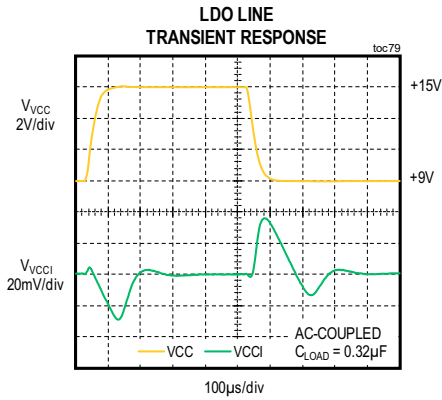

Pin Configuration

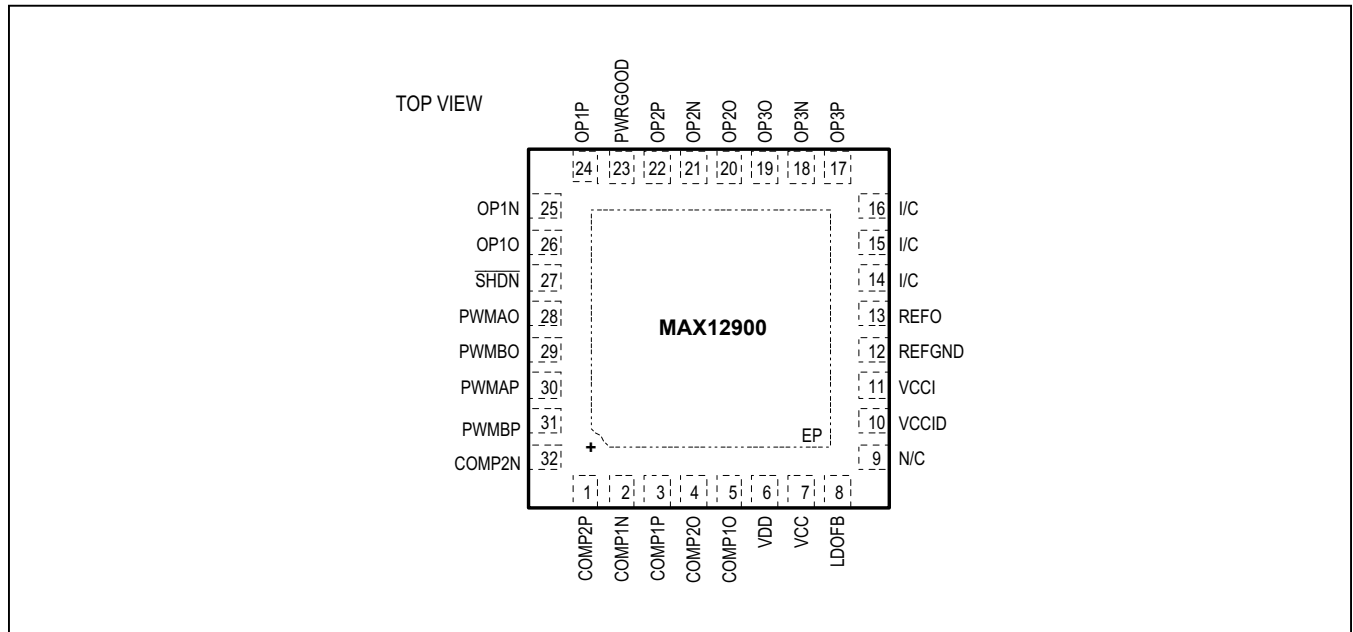

Pin Description

PIN #	NAME	DESCRIPTION
1	COMP2P	Comparator 2 noninverting input
2	COMP1N	Comparator 1 inverting input
3	COMP1P	Comparator 1 noninverting input
4	COMP2O	Comparator 2 output
5	COMP1O	Comparator 1 output
6	VDD	Comparator Output Supply Voltage. Add a 0.1µF bypass cap from VDD to GND.
7	VCC	Positive Supply Voltage at Internal LDO Input. Add a 1µF bypass cap from VCC to GND.
8	LDOFB	LDO feedback voltage. Connect to resistor divider between VCCI and GND.
9	N/C	Not connected
10	VCCID	Digital power input. Connect this pin to VCCI.
11	VCCI	LDO output. Add a 0.22µF bypass cap from VCCI to GND.
12	REFGND	Internal reference ground. Connect to GND.
13	REFO	Internal reference output.
14	I/C	Internally connected pin. Connect this pin to GND.
15	I/C	Internally connected pin. Connect this pin to GND.
16	I/C	Internally connected pin. Connect this pin to GND.
17	OP3P	Op Amp 3 noninverting input
18	OP3N	Op Amp 3 inverting input
19	OP3O	Op Amp 3 output
20	OP2O	Op Amp 2 output

Pin Description (continued)

PIN #	NAME	DESCRIPTION
21	OP2N	Op Amp 2 inverting input
22	OP2P	Op Amp 2 noninverting input
23	PWRGOOD	Active-high output signal that indicates when the MAX12900 is ready.
24	OP1P	Op Amp 1 non-inverting input
25	OP1N	Op Amp 1 inverting input
26	OP1O	Op Amp1 output
27	$\overline{\text{SHDN}}$	Active-Low, Shutdown Input for PWM Conditioners. PWM circuitry powers down and outputs go to Hi-Z state when this pin is low.
28	PWMAO	PWM conditioner output A
29	PWMBO	PWM conditioner output B
30	PWMAP	PWM conditioner input A
31	PWMBP	PWM conditioner input B
32	COMP2N	Comparator 2 inverting input
EP	GND	Exposed pad, chip ground.

Detailed Description

The MAX12900 is an ultra-low-power, highly integrated 4-20mA transmitter. The MAX12900 integrates ten building blocks in a small package: a wide supply voltage range LDO, two comparators for PWM conditioning (PWMA and PWMB), two low-drift, general purpose op amps (OP1 and OP2), one zero-drift, wide-bandwidth op amp (OP3), two diagnostic comparators (COMP1 and COMP2), a power-up sequencer with power good output, and a low-drift voltage reference. There are many ways that one can connect these building blocks to optimize overall functionality and performance of the MAX12900 for a specific application.

Power-Up Sequencer

The power-up sequencer keeps all op amp and PWM outputs at Hi-Z, and outputs of the comparators low during power-up until VCCI reaches 90% of its final value. After that, the PWRGOOD signal is asserted and all outputs become controlled by their inputs. The PWRGOOD signal is delayed by 0.7ms (typ) after VCCI reaches 90% of its final value, thus allowing for external loops controlled by the MAX12900 to stabilize before signaling that the part is ready.

Note that external components, such as a sensor or microcontroller, should not draw load current from VCCI until the PWRGOOD signal has been asserted.

PWM Conditioners

The PWM conditioners generate ground level when the input is below the threshold voltage, and generate V_{REF} when the input is above the threshold voltage. The PWM conditioners can be powered down by setting the $\overline{\text{SHDN}}$ pin low. The PWM outputs are Hi-Z during shutdown.

General Purpose Op Amps (OP1, OP2)

The general purpose op amps, OP1 and OP2, feature a low operating supply voltage, low input bias current, rail-to-rail outputs, and a maximized ratio of Gain Bandwidth Product (GBWP) to supply current. These CMOS devices feature ultra-low input bias current up to 15pA at 85°C. They are unity-gain stable with a 200kHz GBWP, driving capacitive loads up to 100pF. The input common mode voltage range can extend 100mV below ground with excellent common-mode rejection. The OP1 and OP2 op amps can drive the output to within 25mV of both supply rails with a 100kΩ load. Op amp settling time depends primarily on the output voltage and is slew-rate limited.

The general-purpose op amps can be used as PWM filters, linear filters/amplifiers, or as linear or shunt regulator controllers, refer to the [Application Information](#) section.

Zero-Drift High Bandwidth Op Amp (OP3)

The zero-drift, wide bandwidth op amp OP3 uses an innovative auto-zero technique that allows precision and low noise with a minimum amount of power. The ultra-low input offset voltage, offset drift, and 1/f noise allow for building a highly accurate current transmitter. The high GBWP allows for noise suppression over a wider frequency band. The OP3 amplifier achieves rail-to-rail performance at the output.

Driving large capacitive loads can cause instability in many op amps. The OP3 amplifier is stable with capacitive loads up to 300pF. Stability with higher capacitive loads can be improved by adding an isolation resistor in series with the op amp output.

Low-Drift 2.5V Voltage Reference

The precision bandgap reference uses a proprietary curvature-correction circuit and laser-trimmed thin-film resistors, resulting in a low temperature coefficient of <10ppm/°C, and initial accuracy of better than 0.2%. The reference can sink and source up to 500µA, making it attractive for use in low-voltage applications. It is stable for capacitive loads up to 2nF. In applications where the load can experience step changes, an output capacitor will reduce the amount of overshoot (or undershoot) and assist the circuit's transient response. The reference typically turns on and settles to within 0.1% of its final value in 220µs.

General-Purpose Comparators

The comparators COMP1 and COMP2 feature a 2µs propagation delay. Two independent rails supply each comparator. The input stage operates with V_{CCI} from 3.0V to 5.5V, and the output drivers operate with V_{DD} from 1.8V to 3.6V. This allows for a direct connection to a microcontroller. The internal output driver allows for rail-to-rail output swings with up to 100µA load. Both comparators offer a push-pull output that sinks and sources current.

The input common-mode voltage range for these devices extends from 0V to V_{CCI} - 1.3V. The MAX12900's comparators can operate at any differential input voltage within these limits. Input bias current is typically less than 1nA.

These comparators can be used for V_{CC}, V_{DD} or V_{REF} voltage monitoring or other diagnostic functions, providing status information to the microcontroller.

LDO

All components of the MAX12900 are powered from an integrated LDO that generates a 3.0V to 5.5V V_{CCI} voltage from an input V_{CC} voltage of 4.0V to 36V. The LDO provides a clean supply for sensitive analog circuitry. The output of the LDO is set by external resistors and can be selected using the following equation:

$$V_{OUT} = 1.212V \times (1 + R1/R2)$$

Where, 1.212V is an internal reference voltage, R1 and R2 form a resistor divider providing feedback voltage to close the LDO loop, refer to the typical application diagrams. It is recommended that R2 be less than or equal to 470kΩ. For example, for V_{CCI} = 3.3V, R1 = 698k and R2 = 402k can be used from standard 1% E96 resistor series values.

Application Information

Loop-Powered 4-20mA Sensor Transmitter with PWM inputs

One of the possible implementations of a loop powered 4-20mA sensor transmitter is shown in [Figure 2](#). In this application diagram, the PWM inputs from a microcontroller are reshaped by the conditioners, filtered by the OP1 op amp and converted to an analog voltage. The voltage is then converted to a 4-20mA loop current by OP3, an external transistor Q1 and a current sense resistor R_{SENSE}.

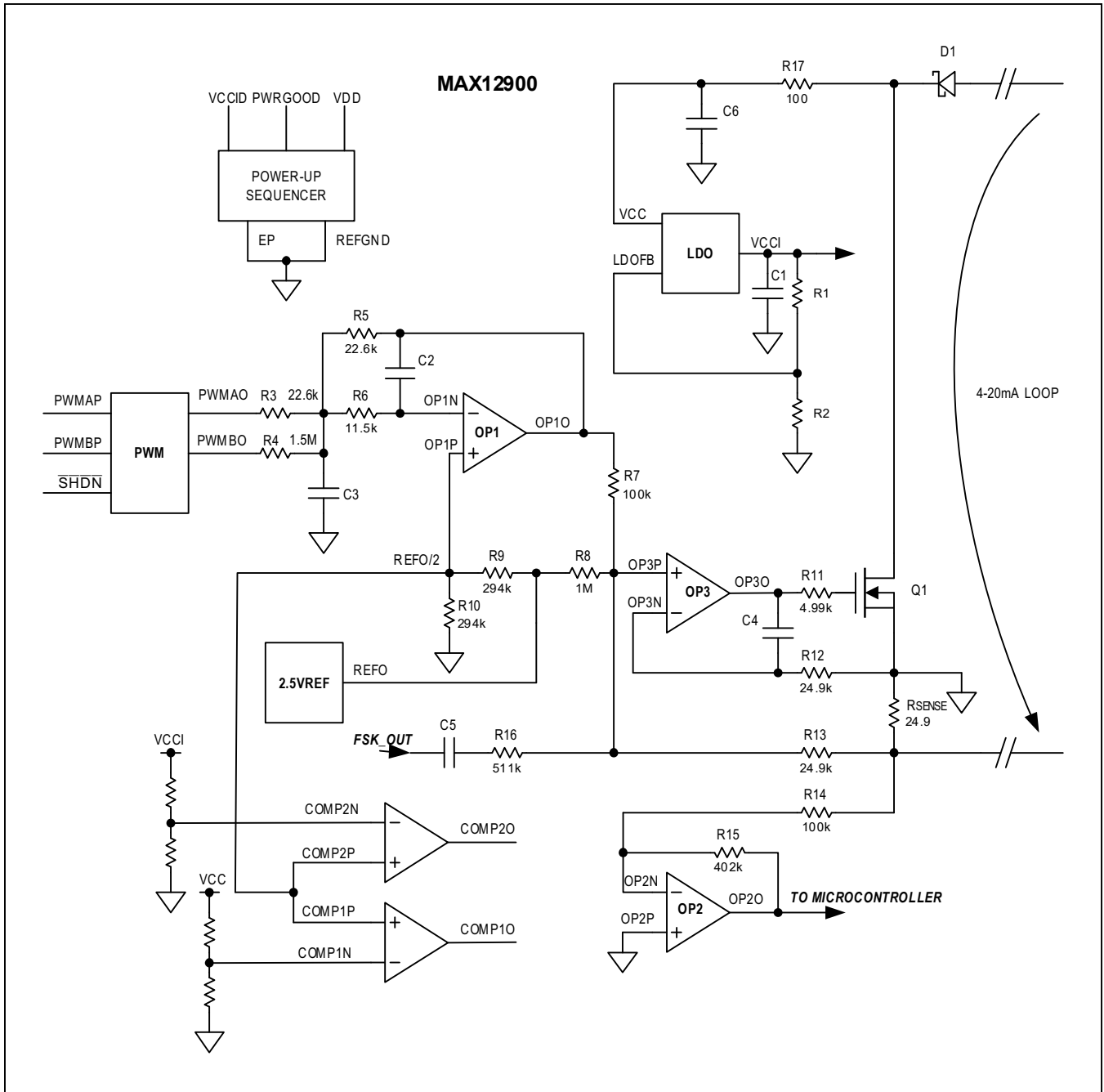

Figure 2. Loop-Powered 4-20mA Transmitter with Two PWM Inputs

The component selection of this circuit is as follows.

Let us assume the loop current range is 2.5mA to 27.5mA including NAMUR burnout detection. With the 24.9Ω R_{SENSE} resistor and the 2.5mA to 27.5mA loop current range, the non-inverting input of OP3 (OP3P) should be in the range 62.25mV (2.5mA x 24.9Ω = 62.25mV) to 684.75mV (27.5mA x 24.9Ω = 684.75mV).

The loop current (I_{loop}) has two components: offset current generated by the reference output (I_{offset}) and PWM signals converted to current (I_{PWMA}, I_{PWMB}).

$$I_{\text{loop}} = I_{\text{offset}} + I_{\text{PWMA}} + I_{\text{PWMB}}$$

After power-up, assuming the PWM signals do not contribute to the loop current, the initial 2.5mA offset current is generated by the reference voltage as follows:

$$I_{\text{offset}} = \frac{\text{REFO} \times R13}{R8 \times R_{\text{SENSE}}}$$

The PWM currents are given by

$$I_{\text{PWMA}} = \frac{\text{PWMADC} \times \text{REFO} \times \left(\frac{R5}{R3}\right) \times R13}{R7 \times R_{\text{SENSE}}}$$

$$I_{\text{PWMB}} = \frac{\text{PWMBDC} \times \text{REFO} \times \left(\frac{R5}{R4}\right) \times R13}{R7 \times R_{\text{SENSE}}}$$

where, PWMADC and PWMBDC are the PWM duty cycles.

DAC Implementation with PWM and Low-Pass Filter

The sensor data received from the microcontroller can be arranged into a coarse and a fine PWM signal.

Both the coarse and fine signals can have up to 8 bits of resolution. The PWM signals are then converted to their voltage level representations via a LPF. The PWM outputs from the MAX12900 connect to the LPF through two gain setting resistors with ratios up to 1:256; the voltage levels at the output of the LPF are proportional to the PWM duty cycles.

The application diagram in [Figure 2](#) shows an implementation of a 14-bit resolution signal path. The PWMAP input receives the coarse signal with 8-bits of resolution, and the PWMBP input receives the fine signal with 6-bits of resolution. A 1:66 ratio is used for the two gain setting resistors.

The coarse gain is set to 1 by using a 22.6kΩ gain resistor R3 and a 22.6kΩ feedback resistor R5, while the fine gain is set to 1/66 by using a 1.5MΩ gain resistor R4. The two PWM outputs are summed via the 22.6kΩ feedback resistor R5 of OP1.

The PWM frequency and filter parameters must satisfy the 4–20mA current loop noise requirements. In this example, the PWM frequency is 10kHz and the 4–20mA transmitter is designed to meet the HART specification. Consequently, the broadband noise of the current loop during silence must be below 138mV_{RMS}, and the in-band noise (500Hz–10kHz) must be below 2.2mV_{RMS} across a 500Ω loop load. In order to reduce the noise level to 2.2mV_{RMS} in-band, the LPF should suppress the noise by more than 60dB (2.5V/2.2mV = 1136.4 or 61dB). Therefore, the cut-off frequency of the LPF should be less than 70Hz with a 40dB/decade roll-off slope. OP1 implements a second-order multi-feedback LPF.

Voltage-Controlled Current Source

The integrated OP3 op amp can be combined with an external current modulating transistor Q1 to implement a precision voltage controlled current source. Q1 can be either an N-MOSFET or a bipolar NPN transistor and needs to satisfy the peak voltage and power dissipation criteria of the current loop. OP3 and Q1, in combination with a few external components, provide an optimal point to compensate the current loop.

Loop Current Diagnostic

In the application example of [Figure 2](#), the second general purpose amplifier (OP2) is used for current diagnostics and provides feedback to the microcontroller.

Connection with a Sensor

The MAX12900 can work with any kind of sensor transmitter, even though it is designed with smart sensors in mind. A smart sensor means that it has an integrated microcontroller and the ability to provide either linear analog or PWM output. If the total current consumption of the transmitter is less than 4mA, power to the sensor and the digital VDD supply can be provided directly from the VCCI pin. If the transmitter requires more than 4mA, an external dc-dc switching converter can be used. Such

a scenario is shown in the application circuit in [Figure 3](#), where OP2 is utilized as a linear voltage regulator and the dc-dc converter powers the microcontroller and drives the VDD supply pin.

Loop Powered 4-20mA Transmitter for Explosion-Proof Devices

If the sensor is to be deployed in hazardous or explosive areas, it must use additional protective components to limit the electrical energy from short circuit or failure conditions, and to prevent sparks that could cause an explosive atmosphere to ignite.

[Figure 4](#) shows an application circuit with improved protection in hazardous environments. In order to limit the electrical energy that goes to the sensor transmitter, an additional Q2 transistor and Zener diodes are added. Typically, a Zener diode should have a clamping voltage from 5V to 12V. In this case, both Q1 and Q2 transistors are the current modulating elements of the circuit. The total 4-20mA loop current is the sum of the current flowing through the Zener diodes, the Q1 transistor and the sensor. Each current path is protected by limiting resistors. Most of the power dissipation is spread out through Q1, Q2 and the Zener diodes, which makes the system design more robust.

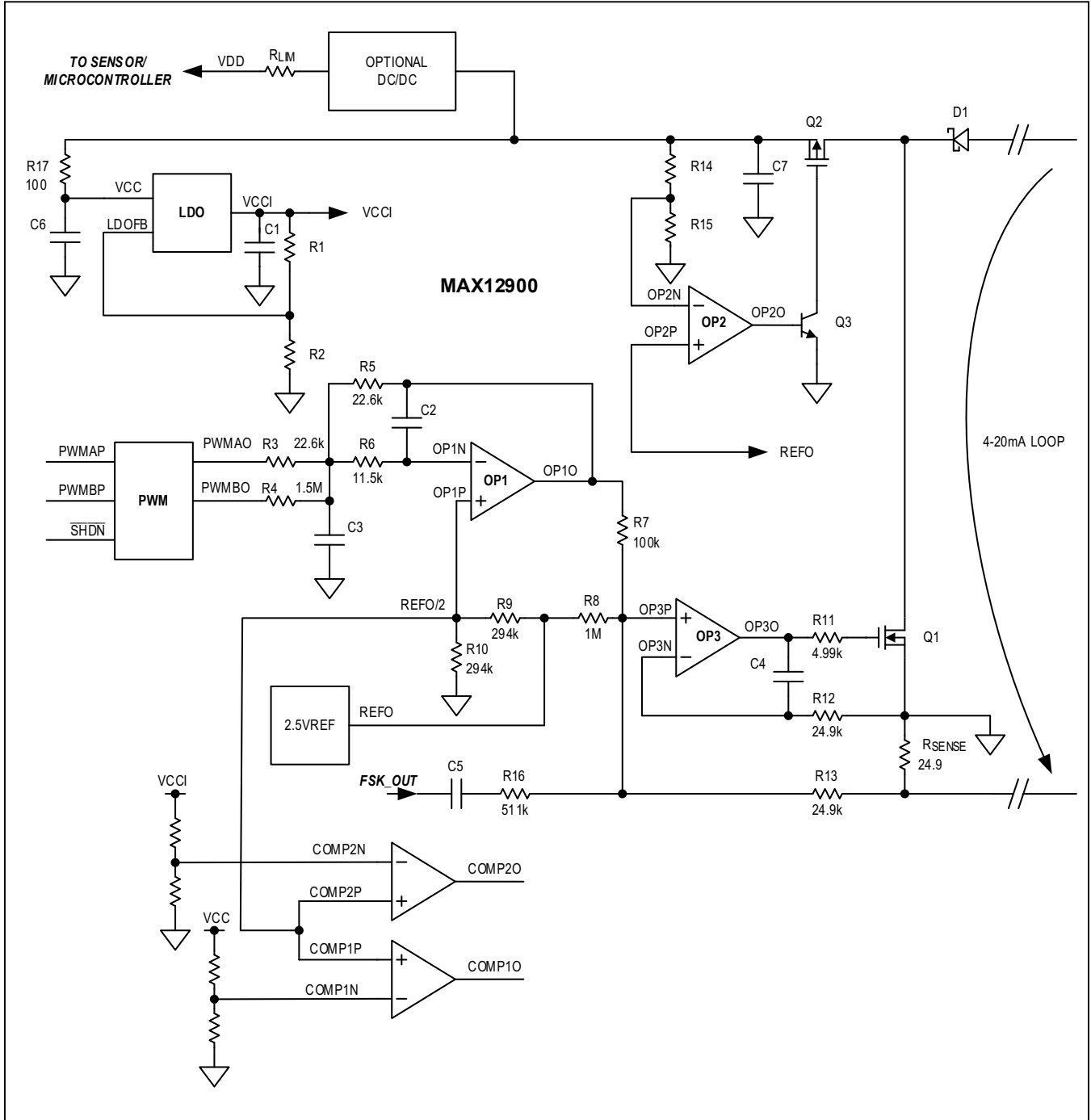

Figure 3. Loop-Powered 4-20mA Transmitter with an External Voltage Regulator

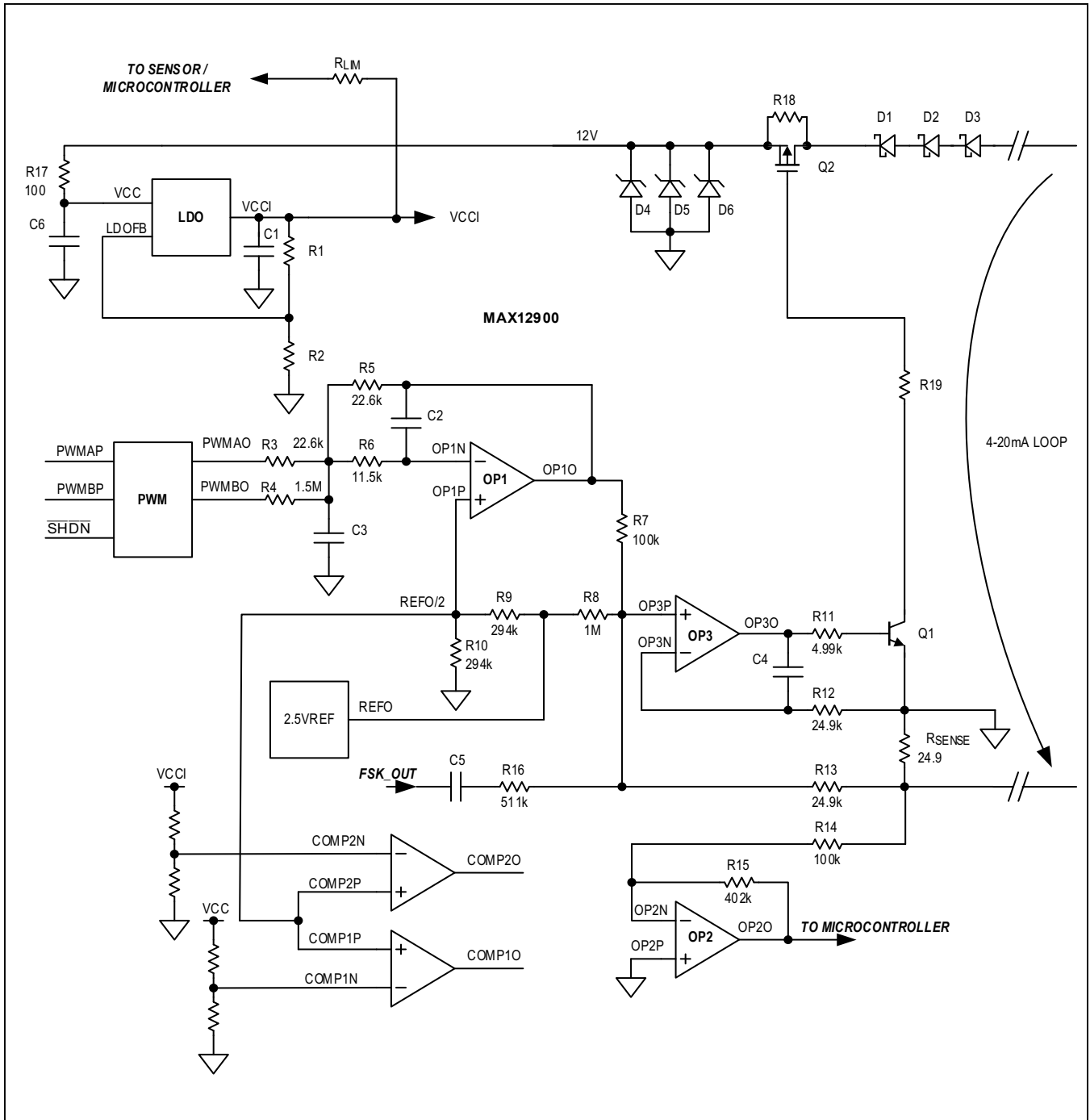

Figure 4. Loop-Powered 4-20mA Transmitter for Hazardous Environments

Ordering Information

PART	PACKAGE	BODY SIZE	PIN PITCH	TEMP RANGE (°C)
MAX12900AATJ+	TQFN32	5mm x 5mm	0.5mm	-40 to +125
MAX12900AATJ+T	TQFN32	5mm x 5mm	0.5mm	-40 to +125

+ Denotes a lead(Pb)-free/RoHS-compliant package.

T = Tape and Reel

Chip Information

PROCESS: BiCMOS

Revision History

REVISION NUMBER	REVISION DATE	DESCRIPTION	PAGES CHANGED
0	9/17	Initial release	—
1	10/17	Updated title of data sheet	1–30
2	3/18	Updated Equation 3	26

For pricing, delivery, and ordering information, please contact Maxim Direct at 1-888-629-4642, or visit Maxim Integrated's website at www.maximintegrated.com.

Maxim Integrated cannot assume responsibility for use of any circuitry other than circuitry entirely embodied in a Maxim Integrated product. No circuit patent licenses are implied. Maxim Integrated reserves the right to change the circuitry and specifications without notice at any time. The parametric values (min and max limits) shown in the Electrical Characteristics table are guaranteed. Other parametric values quoted in this data sheet are provided for guidance.

Компания «Океан Электроники» предлагает заключение долгосрочных отношений при поставках импортных электронных компонентов на взаимовыгодных условиях!

Наши преимущества:

- Поставка оригинальных импортных электронных компонентов напрямую с производств Америки, Европы и Азии, а так же с крупнейших складов мира;
- Широкая линейка поставок активных и пассивных импортных электронных компонентов (более 30 млн. наименований);
- Поставка сложных, дефицитных, либо снятых с производства позиций;
- Оперативные сроки поставки под заказ (от 5 рабочих дней);
- Экспресс доставка в любую точку России;
- Помощь Конструкторского Отдела и консультации квалифицированных инженеров;
- Техническая поддержка проекта, помощь в подборе аналогов, поставка прототипов;
- Поставка электронных компонентов под контролем ВП;
- Система менеджмента качества сертифицирована по Международному стандарту ISO 9001;
- При необходимости вся продукция военного и аэрокосмического назначения проходит испытания и сертификацию в лаборатории (по согласованию с заказчиком);
- Поставка специализированных компонентов военного и аэрокосмического уровня качества (Xilinx, Altera, Analog Devices, Intersil, Interpoint, Microsemi, Actel, Aeroflex, Peregrine, VPT, Syfer, Eurofarad, Texas Instruments, MS Kennedy, Miteq, Cobham, E2V, MA-COM, Hittite, Mini-Circuits, General Dynamics и др.);

Компания «Океан Электроники» является официальным дистрибьютором и эксклюзивным представителем в России одного из крупнейших производителей разъемов военного и аэрокосмического назначения «JONHON», а так же официальным дистрибьютором и эксклюзивным представителем в России производителя высокотехнологичных и надежных решений для передачи СВЧ сигналов «FORSTAR».



JONHON

«JONHON» (основан в 1970 г.)

Разъемы специального, военного и аэрокосмического назначения:

(Применяются в военной, авиационной, аэрокосмической, морской, железнодорожной, горно- и нефтедобывающей отраслях промышленности)

«FORSTAR» (основан в 1998 г.)

ВЧ соединители, коаксиальные кабели, кабельные сборки и микроволновые компоненты:

(Применяются в телекоммуникациях гражданского и специального назначения, в средствах связи, РЛС, а так же военной, авиационной и аэрокосмической отраслях промышленности).



Телефон: 8 (812) 309-75-97 (многоканальный)

Факс: 8 (812) 320-03-32

Электронная почта: ocean@oceanchips.ru

Web: <http://oceanchips.ru/>

Адрес: 198099, г. Санкт-Петербург, ул. Калинина, д. 2, корп. 4, лит. А