

## IR Detector for Mid Range Proximity Sensor

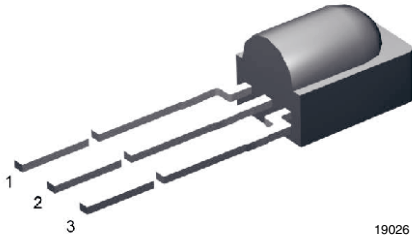

19026

### MECHANICAL DATA

#### Pinning

 1 = OUT, 2 = GND, 3 =  $V_S$ 

### DESCRIPTION

The TSSP58P38 is a compact infrared detector module for proximity sensing application. It receives 38 kHz modulated signals and has a peak sensitivity of 940 nm.

The length of the detector's output pulse varies in proportion to the amount of light reflected from the object being detected.

### FEATURES

- Up to 2 m for proximity sensing
- Receives 38 kHz modulated signal
- 940 nm peak wavelength
- Photo detector and preamplifier in one package
- Low supply current
- Shielding against EMI
- Visible light is suppressed by IR filter
- Insensitive to supply voltage ripple and noise
- Supply voltage: 2.5 V to 5.5 V
- Material categorization: For definitions of compliance please see [www.vishay.com/doc?99912](http://www.vishay.com/doc?99912)



### APPLICATIONS

- Safety switches for garage door, elevator door, gates, and industrial light curtains
- Reflective sensors for toilet, urinal, faucet and hand dryer, and towel dispenser
- Navigational sensor for robotics
- Sensor for large format touch panels
- Object detection in vending machines, parking lots, ATM's, and many others

### PARTS TABLE

CARRIER FREQUENCY	MID RANGE SENSOR
38 kHz <sup>(1)</sup>	TSSP58P38

#### Note

<sup>(1)</sup> Other frequencies available by request

### BLOCK DIAGRAM

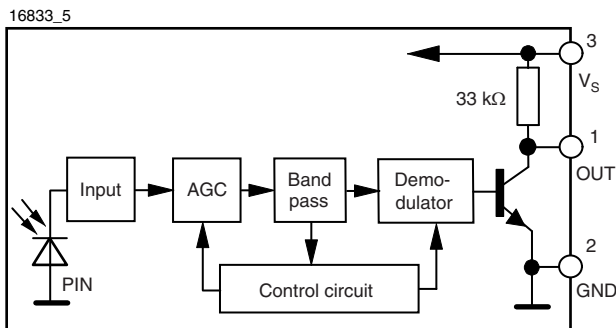

### APPLICATION CIRCUIT

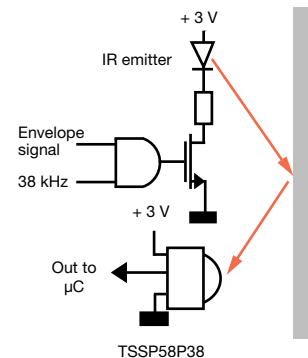

**ABSOLUTE MAXIMUM RATINGS**

PARAMETER	TEST CONDITION	SYMBOL	VALUE	UNIT
Supply voltage (pin 3)		$V_S$	- 0.3 to + 6	V
Supply current (pin 3)		$I_S$	5	mA
Output voltage (pin 1)		$V_O$	- 0.3 to 5.5	V
Voltage at output to supply		$V_S - V_O$	- 0.3 to ( $V_S + 0.3$ )	V
Output current (pin 1)		$I_O$	5	mA
Junction temperature		$T_j$	100	°C
Storage temperature range		$T_{stg}$	- 25 to + 85	°C
Operating temperature range		$T_{amb}$	- 25 to + 85	°C
Power consumption	$T_{amb} \leq 85\text{ °C}$	$P_{tot}$	10	mW
Soldering temperature	$t \leq 10\text{ s}$ , 1 mm from case	$T_{sd}$	260	°C

**Note**

- Stresses beyond those listed under “Absolute Maximum Ratings” may cause permanent damage to the device. This is a stress rating only and functional operation of the device at these or any other conditions beyond those indicated in the operational sections of this specification is not implied. Exposure to absolute maximum rating conditions for extended periods may affect the device reliability.

**ELECTRICAL AND OPTICAL CHARACTERISTICS** ( $T_{amb} = 25\text{ °C}$ , unless otherwise specified)

PARAMETER	TEST CONDITION	SYMBOL	MIN.	TYP.	MAX.	UNIT
Supply current (pin 3)	$E_e = 0$ , $V_S = 5\text{ V}$	$I_{SD}$	0.55	0.7	0.9	mA
	$E_v = 40\text{ klx}$ , sunlight	$I_{SH}$		0.8		mA
Supply voltage		$V_S$	2.5		5.5	V
Receiving distance	Direct line of sight, test signal see fig. 1, IR diode TSAL6200, $I_F = 250\text{ mA}$	$d$		40		m
Output voltage low (pin 1)	$I_{OSL} = 0.5\text{ mA}$ , $E_e = 0.7\text{ mW/m}^2$ , test signal see fig. 1	$V_{OSL}$			100	mV
Minimum irradiance	Pulse width tolerance: $t_{pi} - 5/f_0 < t_{po} < t_{pi} + 6/f_0$ , test signal see fig. 1	$E_e\text{ min.}$		0.2	0.4	mW/m <sup>2</sup>
Maximum irradiance	$t_{pi} - 5/f_0 < t_{po} < t_{pi} + 6/f_0$ , test signal see fig. 1	$E_e\text{ max.}$	50			W/m <sup>2</sup>
Directivity	Angle of half receiving distance	$\varphi_{1/2}$		$\pm 45$		deg

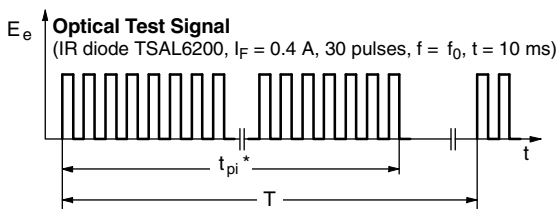
**TYPICAL CHARACTERISTICS** ( $T_{amb} = 25\text{ °C}$ , unless otherwise specified)

\*  $t_{pi} \geq 10/f_0$  is recommended for optimal function

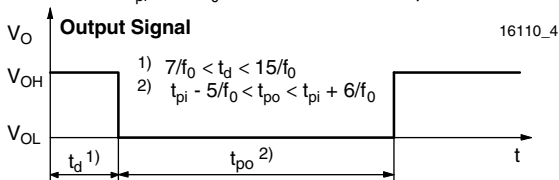

Fig. 1 - Output Active Low

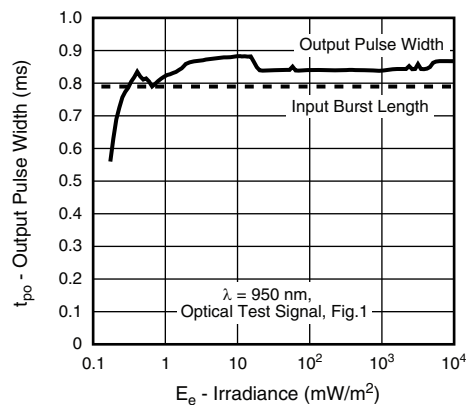

Fig. 2 - Pulse Length and Sensitivity in Dark Ambient

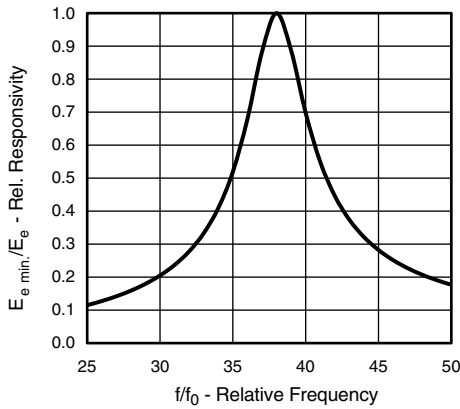

Fig. 3 - Frequency Dependence of Responsivity

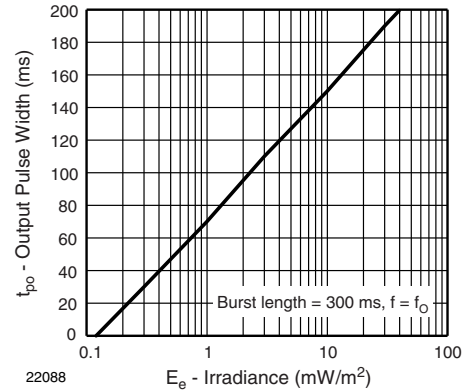

Fig. 6 - Maximum Output Pulse Width vs. Irradiance

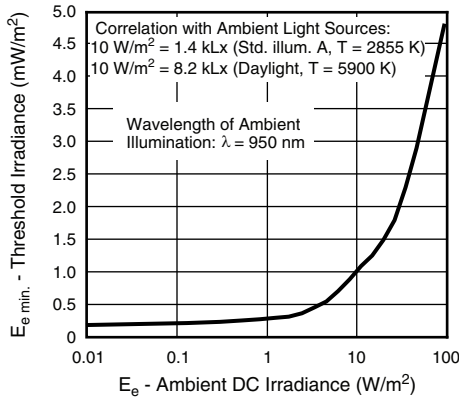

Fig. 4 - Sensitivity in Bright Ambient

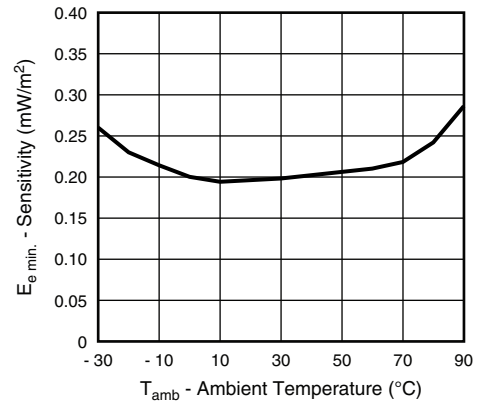

Fig. 7 - Sensitivity vs. Ambient Temperature

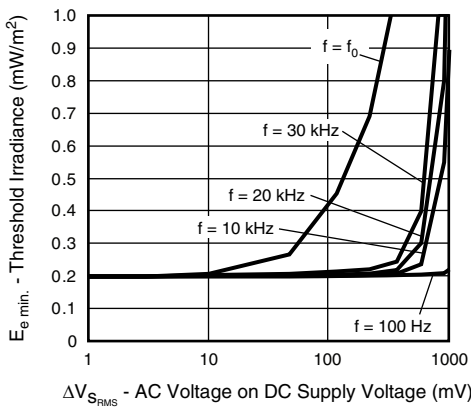

Fig. 5 - Sensitivity vs. Supply Voltage Disturbances

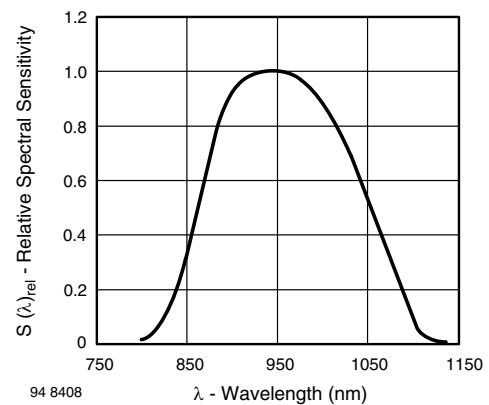

Fig. 8 - Relative Spectral Sensitivity vs. Wavelength

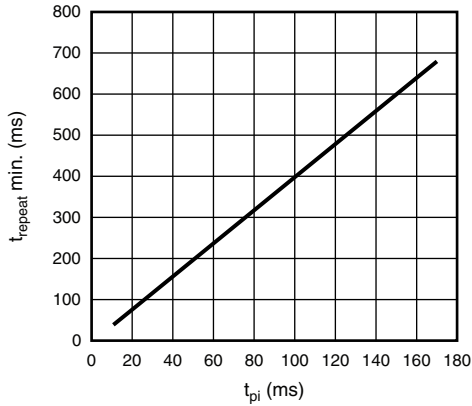

Fig. 9 - Max. Rate of Bursts

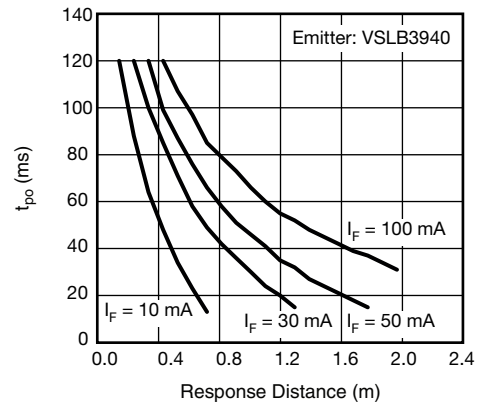

Fig. 11 -  $t_{po}$  vs. Distance Kodak Gray Card Plus 15 %

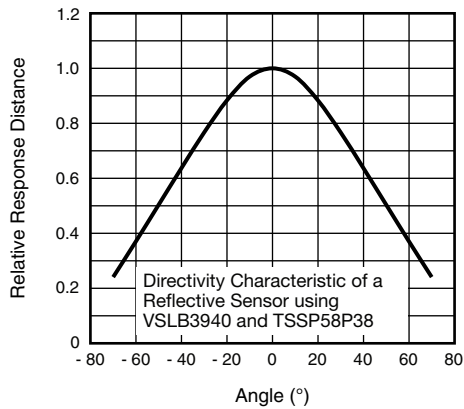

Fig. 10 - Angle Characteristic

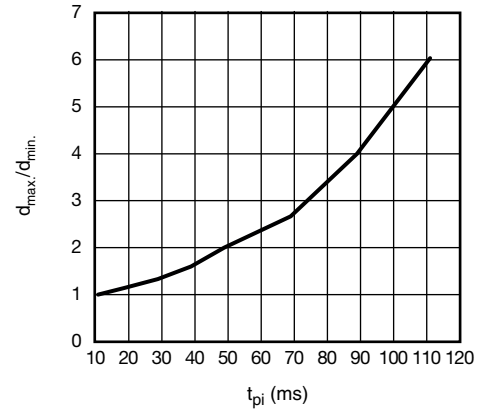
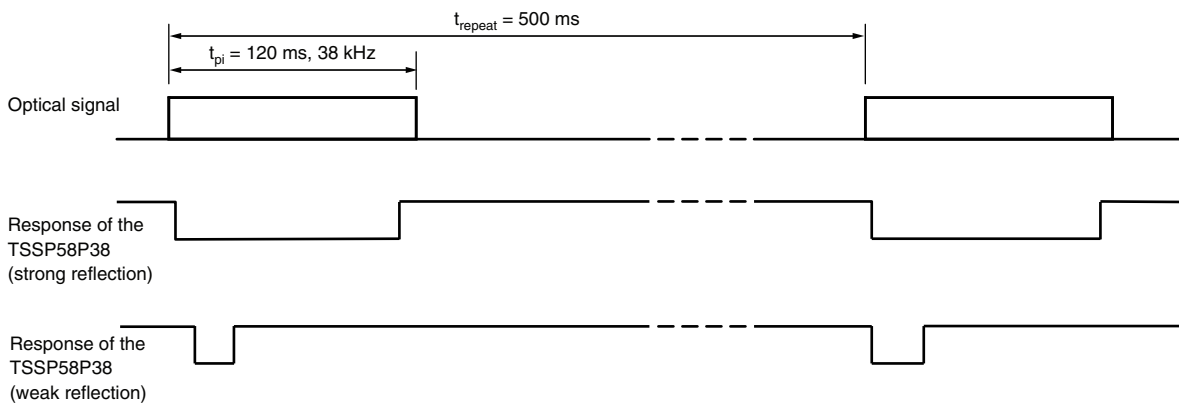

Fig. 12 - Dynamic Range of Sensor vs.  $t_{pi}$

The typical application of the TSSP58P38 is a reflective sensor with analog information contained in its output. Such a sensor is evaluating the time required by the AGC to suppress a quasi continuous signal. The time required to suppress such a signal is longer when the signal is strong than when the signal is weak, resulting in a pulse length corresponding to the distance of an object from the sensor. This kind of analog information can be evaluated by a microcontroller. The absolute amount of reflected light depends much on the environment and is not evaluated. Only sudden changes of the amount of reflected light, and therefore changes in the pulse width, are evaluated using this application.

Example of a signal pattern:



Example for a sensor hardware:

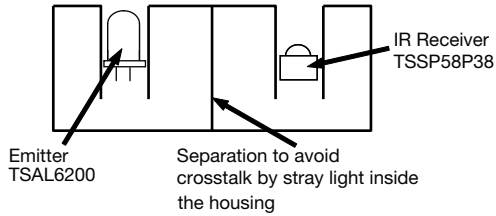

There should be no common window in front of the emitter and receiver in order to avoid crosstalk by guided light through the window.

The logarithmic characteristic of the AGC in the TSSP58P38 results in an almost linear relationship between distance and pulse width. Ambient light has also some impact to the pulse width of this kind of sensor, making the pulse shorter.

## PACKAGE DIMENSIONS in millimeters

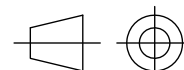
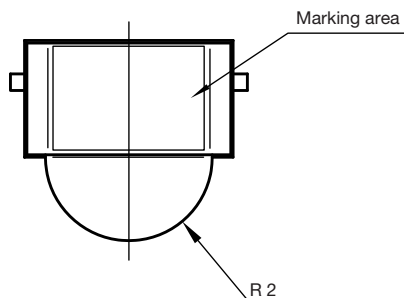
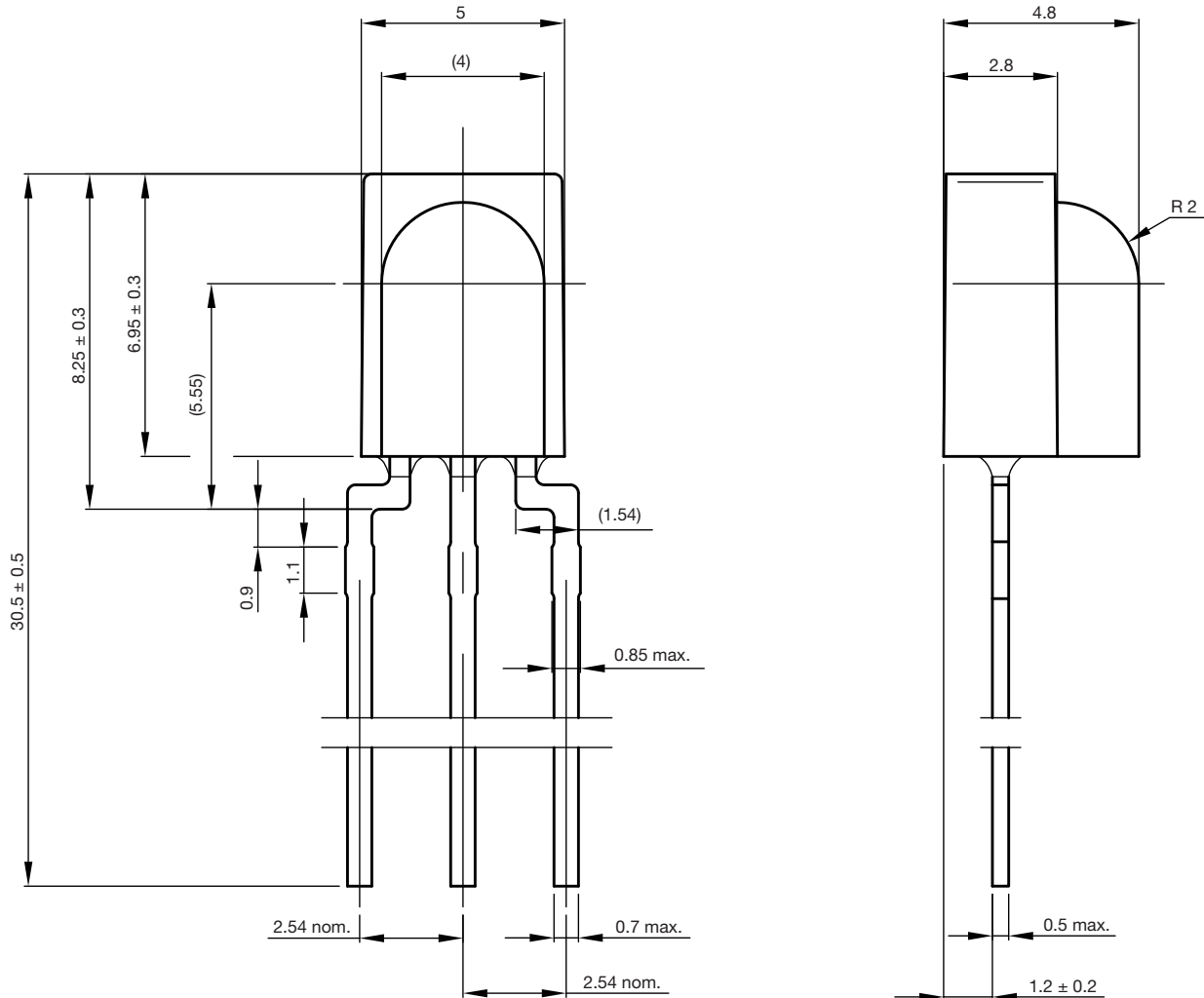

technical drawings according to DIN specifications

Not indicated to tolerances  $\pm 0.2$

Drawing-No.: 6.550-5263.01-4

Issue: 12; 16.04.10

19009



## Disclaimer

ALL PRODUCT, PRODUCT SPECIFICATIONS AND DATA ARE SUBJECT TO CHANGE WITHOUT NOTICE TO IMPROVE RELIABILITY, FUNCTION OR DESIGN OR OTHERWISE.

Vishay Intertechnology, Inc., its affiliates, agents, and employees, and all persons acting on its or their behalf (collectively, "Vishay"), disclaim any and all liability for any errors, inaccuracies or incompleteness contained in any datasheet or in any other disclosure relating to any product.

Vishay makes no warranty, representation or guarantee regarding the suitability of the products for any particular purpose or the continuing production of any product. To the maximum extent permitted by applicable law, Vishay disclaims (i) any and all liability arising out of the application or use of any product, (ii) any and all liability, including without limitation special, consequential or incidental damages, and (iii) any and all implied warranties, including warranties of fitness for particular purpose, non-infringement and merchantability.

Statements regarding the suitability of products for certain types of applications are based on Vishay's knowledge of typical requirements that are often placed on Vishay products in generic applications. Such statements are not binding statements about the suitability of products for a particular application. It is the customer's responsibility to validate that a particular product with the properties described in the product specification is suitable for use in a particular application. Parameters provided in datasheets and/or specifications may vary in different applications and performance may vary over time. All operating parameters, including typical parameters, must be validated for each customer application by the customer's technical experts. Product specifications do not expand or otherwise modify Vishay's terms and conditions of purchase, including but not limited to the warranty expressed therein.

Except as expressly indicated in writing, Vishay products are not designed for use in medical, life-saving, or life-sustaining applications or for any other application in which the failure of the Vishay product could result in personal injury or death. Customers using or selling Vishay products not expressly indicated for use in such applications do so at their own risk. Please contact authorized Vishay personnel to obtain written terms and conditions regarding products designed for such applications.

No license, express or implied, by estoppel or otherwise, to any intellectual property rights is granted by this document or by any conduct of Vishay. Product names and markings noted herein may be trademarks of their respective owners.

## Material Category Policy

**Vishay Intertechnology, Inc. hereby certifies that all its products that are identified as RoHS-Compliant fulfill the definitions and restrictions defined under Directive 2011/65/EU of The European Parliament and of the Council of June 8, 2011 on the restriction of the use of certain hazardous substances in electrical and electronic equipment (EEE) - recast, unless otherwise specified as non-compliant.**

**Please note that some Vishay documentation may still make reference to RoHS Directive 2002/95/EC. We confirm that all the products identified as being compliant to Directive 2002/95/EC conform to Directive 2011/65/EU.**

**Vishay Intertechnology, Inc. hereby certifies that all its products that are identified as Halogen-Free follow Halogen-Free requirements as per JEDEC JS709A standards. Please note that some Vishay documentation may still make reference to the IEC 61249-2-21 definition. We confirm that all the products identified as being compliant to IEC 61249-2-21 conform to JEDEC JS709A standards.**

Компания «Океан Электроники» предлагает заключение долгосрочных отношений при поставках импортных электронных компонентов на взаимовыгодных условиях!

Наши преимущества:

- Поставка оригинальных импортных электронных компонентов напрямую с производств Америки, Европы и Азии, а так же с крупнейших складов мира;
- Широкая линейка поставок активных и пассивных импортных электронных компонентов (более 30 млн. наименований);
- Поставка сложных, дефицитных, либо снятых с производства позиций;
- Оперативные сроки поставки под заказ (от 5 рабочих дней);
- Экспресс доставка в любую точку России;
- Помощь Конструкторского Отдела и консультации квалифицированных инженеров;
- Техническая поддержка проекта, помощь в подборе аналогов, поставка прототипов;
- Поставка электронных компонентов под контролем ВП;
- Система менеджмента качества сертифицирована по Международному стандарту ISO 9001;
- При необходимости вся продукция военного и аэрокосмического назначения проходит испытания и сертификацию в лаборатории (по согласованию с заказчиком);
- Поставка специализированных компонентов военного и аэрокосмического уровня качества (Xilinx, Altera, Analog Devices, Intersil, Interpoint, Microsemi, Actel, Aeroflex, Peregrine, VPT, Syfer, Eurofarad, Texas Instruments, MS Kennedy, Miteq, Cobham, E2V, MA-COM, Hittite, Mini-Circuits, General Dynamics и др.);

Компания «Океан Электроники» является официальным дистрибьютором и эксклюзивным представителем в России одного из крупнейших производителей разъемов военного и аэрокосмического назначения «**JONHON**», а так же официальным дистрибьютором и эксклюзивным представителем в России производителя высокотехнологичных и надежных решений для передачи СВЧ сигналов «**FORSTAR**».



## JONHON

«**JONHON**» (основан в 1970 г.)

Разъемы специального, военного и аэрокосмического назначения:

(Применяются в военной, авиационной, аэрокосмической, морской, железнодорожной, горно- и нефтедобывающей отраслях промышленности)

«**FORSTAR**» (основан в 1998 г.)

ВЧ соединители, коаксиальные кабели, кабельные сборки и микроволновые компоненты:

(Применяются в телекоммуникациях гражданского и специального назначения, в средствах связи, РЛС, а так же военной, авиационной и аэрокосмической отраслях промышленности).



Телефон: 8 (812) 309-75-97 (многоканальный)

Факс: 8 (812) 320-03-32

Электронная почта: [ocean@oceanchips.ru](mailto:ocean@oceanchips.ru)

Web: <http://oceanchips.ru/>

Адрес: 198099, г. Санкт-Петербург, ул. Калинина, д. 2, корп. 4, лит. А