

FEATURES

- Precision power supply monitoring**
- 31 reset threshold options: 1.58 V to 5.0 V**
- Four reset timeouts: 1 ms, 20 ms, 140 ms, and 1120 ms**
- Manual reset input**
- Reset output stage**
- Push-pull active-low**
- Guaranteed reset output valid to $V_{CC} = 1$ V**
- Power supply glitch immunity**
- Specified over the -40°C to $+125^{\circ}\text{C}$ temperature range**
- 4-lead SC70 package**

APPLICATIONS

- Microprocessor systems**
- Computers**
- Controllers**
- Intelligent instruments**
- Portable equipment**

GENERAL DESCRIPTION

The ADM6384 is a supervisory circuit that monitors power supply voltage levels in microprocessor-based systems. A power-on reset signal is generated when the supply voltage rises to a preset threshold level. The debounced manual reset input of the ADM6384 can be used to initiate a reset by means of an external push button or logic signal.

The part is available in a choice of 31 reset threshold options, from 1.58 V to 5.0 V. The minimum reset timeout periods are 1 ms, 20 ms, 140 ms, and 1120 ms.

The ADM6384 is available in a 4-lead SC70 package and typically consumes only 7 μA , making it suitable for use in low power, portable applications.

FUNCTIONAL BLOCK DIAGRAMS



Figure 1.

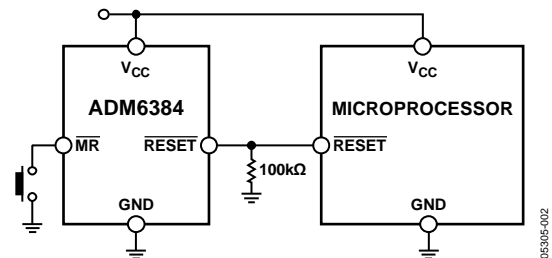

Figure 2.

Rev. C

Information furnished by Analog Devices is believed to be accurate and reliable. However, no responsibility is assumed by Analog Devices for its use, nor for any infringements of patents or other rights of third parties that may result from its use. Specifications subject to change without notice. No license is granted by implication or otherwise under any patent or patent rights of Analog Devices. Trademarks and registered trademarks are the property of their respective owners.

TABLE OF CONTENTS

Features	1	Typical Performance Characteristics	7
Applications.....	1	Circuit Description.....	9
General Description	1	Reset Output	9
Functional Block Diagrams.....	1	Manual Reset Input	9
Revision History	2	Applications Information	10
Specifications.....	3	Negative-Going V_{CC} Transients	10
Absolute Maximum Ratings.....	5	Ensuring Reset Valid to $V_{CC} = 0\text{ V}$	10
ESD Caution.....	5	Outline Dimensions	11
Pin Configuration and Function Descriptions.....	6	Ordering Guide	11

REVISION HISTORY

4/11—Rev. B to Rev. C

Updated Outline Dimensions	11
Changes to Ordering Guide	11

7/08—Rev. A to Rev. B

Changes to Figure 5, Figure 8, and Figure 9.....	7
Changes to Figure 10.....	8
Changes to Figure 15.....	11
Changes to Ordering Guide	11

1/07—Rev. 0 to Rev. A

Updated Format.....	Universal
Changes to Specifications Table.....	3
Updated Outline Dimensions	11
Changes to Ordering Guide	11

7/05—Revision 0: Initial Version

SPECIFICATIONS

V_{CC} = full operating range, T_A = -40°C to $+125^{\circ}\text{C}$, unless otherwise noted.

Table 1.

Parameter	Min	Typ	Max	Unit	Test Conditions/Comments
SUPPLY					
V_{CC} Operating Voltage Range	1		5.5	V	
Supply Current		7	13	μA	$V_{CC} = 5.5\text{ V}$, no load
		6	11	μA	$V_{CC} = 3.6\text{ V}$, no load
		4	7	μA	$V_{CC} = 2.5\text{ V}$, no load ¹
		3	6	μA	$V_{CC} = 1.8\text{ V}$, no load ¹
RESET THRESHOLD VOLTAGE					
ADM6384x50x	4.88	5.00	5.12	V	
ADM6384x49x	4.78	4.90	5.02	V	
ADM6384x48x	4.68	4.80	4.92	V	
ADM6384x47x	4.58	4.70	4.82	V	
ADM6384x46x	4.51	4.63	4.74	V	
ADM6384x45x	4.39	4.5	4.61	V	
ADM6384x44x	4.27	4.38	4.48	V	
ADM6384x43x	4.19	4.30	4.41	V	
ADM6384x42x	4.1	4.2	4.31	V	
ADM6384x41x	4.0	4.1	4.2	V	
ADM6384x40x	3.9	4.0	4.1	V	
ADM6384x39x	3.8	3.9	4.0	V	
ADM6384x38x	3.71	3.8	3.9	V	
ADM6384x37x	3.61	3.7	3.79	V	
ADM6384x36x	3.51	3.6	3.69	V	
ADM6384x35x	3.41	3.5	3.59	V	
ADM6384x34x	3.32	3.4	3.49	V	
ADM6384x33x	3.22	3.3	3.38	V	
ADM6384x32x	3.12	3.2	3.28	V	
ADM6384x31x	3.00	3.08	3.15	V	
ADM6384x30x	2.93	3.0	3.08	V	
ADM6384x29x	2.85	2.93	3.00	V	
ADM6384x28x	2.73	2.8	2.87	V	
ADM6384x27x	2.63	2.70	2.77	V	
ADM6384x26x	2.56	2.63	2.69	V	
ADM6384x25x	2.44	2.5	2.56	V	
ADM6384x24x	2.34	2.4	2.46	V	
ADM6384x23x	2.26	2.31	2.37	V	
ADM6384x22x	2.13	2.19	2.24	V	
ADM6384x17x	1.62	1.67	1.71	V	
ADM6384x16x	1.54	1.58	1.61	V	
RESET THRESHOLD TEMPERATURE COEFFICIENT					
V_{CC} to Reset Delay		60		ppm/ $^{\circ}\text{C}$	
		35		μs	V_{CC} falling at 10 mV/ μs from $V_{TH} + 100\text{ mV}$ to $V_{TH} - 100\text{ mV}$
RESET THRESHOLD HYSTERESIS					
		$2 \times V_{TH}$		mV	
RESET TIMEOUT PERIOD					
ADM6384xxD1	1		2	ms	
ADM6384xxD2	20		40	ms	
ADM6384xxD3	140		280	ms	
ADM6384xxD4	1120		2240	ms	

ADM6384

Parameter	Min	Typ	Max	Unit	Test Conditions/Comments
MANUAL RESET INPUT					
$\overline{\text{MR}}$ Input Threshold					
V_{IL}			$0.3 \times V_{\text{CC}}$	V	$V_{\text{CC}} < 4\text{ V}$
			0.8	V	$V_{\text{CC}} > 4\text{ V}$
V_{IH}	$0.7 \times V_{\text{CC}}$			V	$V_{\text{CC}} < 4\text{ V}$
	2.4			V	$V_{\text{CC}} > 4\text{ V}$
$\overline{\text{MR}}$ Input Pulse Width	1			μs	
$\overline{\text{MR}}$ Glitch Rejection		100		ns	
$\overline{\text{MR}}$ Pull-Up Resistance	32	63	100	kV	
$\overline{\text{MR}}$ to Reset Delay		200		ns	
RESET OUTPUT VOLTAGE					
V_{OL}			0.3	V	$V_{\text{CC}} \geq 1.0\text{ V}, I_{\text{SINK}} = 80\ \mu\text{A}$
			0.3	V	$V_{\text{CC}} \geq 2.5\text{ V}, I_{\text{SINK}} = 1.2\text{ mA}$
			0.4	V	$V_{\text{CC}} \geq 4.5\text{ V}, I_{\text{SINK}} = 3.2\text{ mA}$
V_{OH}	$0.8 \times V_{\text{CC}}$			V	$V_{\text{CC}} \geq 2.5\text{ V}, I_{\text{SOURCE}} = 500\ \mu\text{A}$
	$0.8 \times V_{\text{CC}}$			V	$V_{\text{CC}} \geq 4.5\text{ V}, I_{\text{SOURCE}} = 800\ \mu\text{A}$

¹ $T_{\text{A}} = 25^{\circ}\text{C}$ only.

ABSOLUTE MAXIMUM RATINGS

$T_A = 25^\circ\text{C}$, unless otherwise noted.

Table 2.

Parameter	Rating
V_{CC}	-0.3 V to +6 V
$\overline{\text{RESET}}$	-0.3 V to +6 V
Output Current ($\overline{\text{RESET}}$)	20 mA
Operating Temperature Range	-40°C to +125°C
Storage Temperature Range	-65°C to +150°C
θ_{JA} Thermal Impedance, SC70	331°C/W
Soldering Temperature	
Sn/Pb	240°C, 30 sec
Pb-Free	260°C, 40 sec

Stresses above those listed under Absolute Maximum Ratings may cause permanent damage to the device. This is a stress rating only; functional operation of the device at these or any other conditions above those indicated in the operational section of this specification is not implied. Exposure to absolute maximum rating conditions for extended periods may affect device reliability.

ESD CAUTION



ESD (electrostatic discharge) sensitive device.

Charged devices and circuit boards can discharge without detection. Although this product features patented or proprietary protection circuitry, damage may occur on devices subjected to high energy ESD. Therefore, proper ESD precautions should be taken to avoid performance degradation or loss of functionality.

ADM6384

PIN CONFIGURATION AND FUNCTION DESCRIPTIONS



Figure 3. Pin Configuration

Table 3. Pin Function Descriptions

Pin No.	Mnemonic	Description
1	GND	Ground.
2	$\overline{\text{RESET}}$	Active-Low Reset Output. This is an active-low output that is asserted whenever V_{CC} is below the reset threshold (V_{TH}). It features a push-pull output stage.
3	$\overline{\text{MR}}$	Manual Reset Input. This is an active-low input that, when forced low for at least 1 μs , generates a reset. It features a 52 kV internal pull-up.
4	V_{CC}	Power Supply Voltage Being Monitored.

TYPICAL PERFORMANCE CHARACTERISTICS



Figure 4. Supply Current vs. Temperature

05305-004



Figure 7. Normalized Reset Threshold vs. Temperature

05305-007



Figure 5. Normalized Reset Timeout Period vs. Temperature

05305-005



Figure 8. Output Voltage Low vs. I_{SINK}

05305-006



Figure 6. V_{CC} to Reset Output Delay vs. Temperature

05305-006



Figure 9. Output Voltage High vs. I_{SOURCE}

05305-008

ADM6384



Figure 10. Maximum V_{CC} Transient Duration vs. Reset Threshold Overdrive



Figure 11. Manual Reset Minimum Pulse Width vs. Temperature

CIRCUIT DESCRIPTION

The ADM6384 provides microprocessor supply voltage supervision by controlling the microprocessor reset input. Code execution errors are avoided during power-up, power-down, and brownout conditions by asserting a reset signal when the supply voltage is below a preset threshold. In addition, the ADM6384 allows supply voltage stabilization with a fixed timeout before the reset deasserts after the supply voltage rises above the threshold. If the user detects a problem with the system operation, a manual reset input is available to reset the microprocessor by means of an external push-button, for example.

RESET OUTPUT

The ADM6384 features an active-low, push-pull reset output. The reset signal is guaranteed to be logic low for V_{CC} down to 1 V.

The reset output is asserted when V_{CC} is below the reset threshold (V_{TH}) or when \overline{MR} is driven low. Reset remains asserted for the duration of the reset active timeout period (t_{RP}) after V_{CC} rises above the reset threshold or after \overline{MR} transitions from low to high. Figure 12 illustrates the behavior of the reset outputs.



Figure 12. Reset Timing Diagram

MANUAL RESET INPUT

The ADM6384 features a manual reset input (\overline{MR}) that, when driven low, asserts the reset output. When \overline{MR} transitions from low to high, reset remains asserted for the duration of the reset active timeout period before deasserting. The \overline{MR} input has a 52 k Ω internal pull-up so that the input is always high when unconnected. An external push-button switch can be connected between \overline{MR} and ground so that the user can generate a reset. Debounce circuitry for this purpose is integrated on-chip. Noise immunity is provided on the \overline{MR} input, and fast, negative-going transients of up to 100 ns (typical) are ignored. A 0.1 μ F capacitor between \overline{MR} and ground provides additional noise immunity.

APPLICATIONS INFORMATION

NEGATIVE-GOING V_{CC} TRANSIENTS

To avoid unnecessary resets caused by fast power supply transients, the ADM6384 is equipped with glitch rejection circuitry. The typical performance characteristic shown in Figure 10 plots V_{CC} transient duration vs. the transient magnitude. The curves show combinations of transient magnitude and duration for which a reset is not generated for 4.63 V and 2.93 V reset threshold parts. For example, with the 2.93 V threshold, a transient that goes 100 mV below the threshold and lasts 8 μ s typically does not cause a reset, but if the transient is any greater in magnitude or duration, a reset is generated. An optional 0.1 μ F bypass capacitor mounted close to V_{CC} provides additional glitch rejection.

ENSURING RESET VALID TO $V_{CC} = 0$ V

Both active-low and active-high reset outputs are guaranteed to be valid for V_{CC} as low as 1 V. However, by using an external resistor with push-pull configured reset outputs, valid outputs for V_{CC} as low as 0 V are possible. For an active-low reset output, a resistor connected between $\overline{\text{RESET}}$ and ground pulls the output low when it is unable to sink current. A large resistance such as 100 k Ω should be used to avoid overloading the reset output when V_{CC} is above 1 V.



Figure 13. Ensuring Reset Valid to $V_{CC} = 0$ V

OUTLINE DIMENSIONS



*PACKAGE OUTLINE CORRESPONDS IN FULL TO EIAJ SC82 EXCEPT FOR WIDTH OF PIN 2 AS SHOWN.

Figure 14. 4-Lead Thin Shrink Small Outline Transistor Package [SC70] (KS-4)

Dimensions shown in millimeters

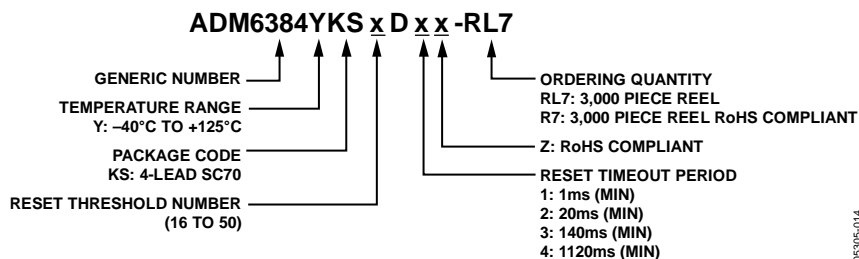

Figure 15. Ordering Code Structure

ORDERING GUIDE

Standard Models ^{1,2}	Reset Threshold (V)	Reset Timeout (ms)	Temperature Range	Quantity	Package Description	Package Option	Branding
ADM6384YKS23D3Z-R7	2.31	140	-40°C to +125°C	3k	4-Lead SC70	KS-4	NOR
ADM6384YKS26D3Z-R7	2.63	140	-40°C to +125°C	3k	4-Lead SC70	KS-4	NOR
ADM6384YKS29D1Z-R7	2.93	1	-40°C to +125°C	3k	4-Lead SC70	KS-4	NOR
ADM6384YKS29D3Z-R7	2.93	140	-40°C to +125°C	3k	4-Lead SC70	KS-4	NOR
ADM6384YKS31D1Z-R7	3.08	1	-40°C to +125°C	3k	4-Lead SC70	KS-4	NOR
ADM6384YKS31D2Z-R7	3.08	20	-40°C to +125°C	3k	4-Lead SC70	KS-4	NOR
ADM6384YKS34D2Z-R7	3.4	20	-40°C to +125°C	3k	4-Lead SC70	KS-4	NOR
ADM6384YKS39D2Z-R7	3.9	20	-40°C to +125°C	3k	4-Lead SC70	KS-4	NOR
ADM6384YKS45D3Z-R7	4.5	140	-40°C to +125°C	3k	4-Lead SC70	KS-4	NOR
ADM6384YKS46D2Z-R7	4.63	20	-40°C to +125°C	3k	4-Lead SC70	KS-4	NOR

¹ If ordering nonstandard models, complete the ordering code shown in Figure 15 by inserting reset timeout and reset threshold suffixes. Contact sales for availability of nonstandard models.

² Z = RoHS Compliant Part.

NOTES

Компания «Океан Электроники» предлагает заключение долгосрочных отношений при поставках импортных электронных компонентов на взаимовыгодных условиях!

Наши преимущества:

- Поставка оригинальных импортных электронных компонентов напрямую с производств Америки, Европы и Азии, а так же с крупнейших складов мира;
- Широкая линейка поставок активных и пассивных импортных электронных компонентов (более 30 млн. наименований);
- Поставка сложных, дефицитных, либо снятых с производства позиций;
- Оперативные сроки поставки под заказ (от 5 рабочих дней);
- Экспресс доставка в любую точку России;
- Помощь Конструкторского Отдела и консультации квалифицированных инженеров;
- Техническая поддержка проекта, помощь в подборе аналогов, поставка прототипов;
- Поставка электронных компонентов под контролем ВП;
- Система менеджмента качества сертифицирована по Международному стандарту ISO 9001;
- При необходимости вся продукция военного и аэрокосмического назначения проходит испытания и сертификацию в лаборатории (по согласованию с заказчиком);
- Поставка специализированных компонентов военного и аэрокосмического уровня качества (Xilinx, Altera, Analog Devices, Intersil, Interpoint, Microsemi, Actel, Aeroflex, Peregrine, VPT, Syfer, Eurofarad, Texas Instruments, MS Kennedy, Miteq, Cobham, E2V, MA-COM, Hittite, Mini-Circuits, General Dynamics и др.);

Компания «Океан Электроники» является официальным дистрибьютором и эксклюзивным представителем в России одного из крупнейших производителей разъемов военного и аэрокосмического назначения «JONHON», а так же официальным дистрибьютором и эксклюзивным представителем в России производителя высокотехнологичных и надежных решений для передачи СВЧ сигналов «FORSTAR».



JONHON

«JONHON» (основан в 1970 г.)

Разъемы специального, военного и аэрокосмического назначения:

(Применяются в военной, авиационной, аэрокосмической, морской, железнодорожной, горно- и нефтедобывающей отраслях промышленности)

«FORSTAR» (основан в 1998 г.)

ВЧ соединители, коаксиальные кабели,
кабельные сборки и микроволновые компоненты:

(Применяются в телекоммуникациях гражданского и специального назначения, в средствах связи, РЛС, а так же военной, авиационной и аэрокосмической отраслях промышленности).



Телефон: 8 (812) 309-75-97 (многоканальный)

Факс: 8 (812) 320-03-32

Электронная почта: ocean@oceanchips.ru

Web: <http://oceanchips.ru/>

Адрес: 198099, г. Санкт-Петербург, ул. Калинина, д. 2, корп. 4, лит. А