



MCP73831
Evaluation Board
User's Guide

Note the following details of the code protection feature on Microchip devices:

- Microchip products meet the specification contained in their particular Microchip Data Sheet.
- Microchip believes that its family of products is one of the most secure families of its kind on the market today, when used in the intended manner and under normal conditions.
- There are dishonest and possibly illegal methods used to breach the code protection feature. All of these methods, to our knowledge, require using the Microchip products in a manner outside the operating specifications contained in Microchip's Data Sheets. Most likely, the person doing so is engaged in theft of intellectual property.
- Microchip is willing to work with the customer who is concerned about the integrity of their code.
- Neither Microchip nor any other semiconductor manufacturer can guarantee the security of their code. Code protection does not mean that we are guaranteeing the product as "unbreakable."

Code protection is constantly evolving. We at Microchip are committed to continuously improving the code protection features of our products. Attempts to break Microchip's code protection feature may be a violation of the Digital Millennium Copyright Act. If such acts allow unauthorized access to your software or other copyrighted work, you may have a right to sue for relief under that Act.

Information contained in this publication regarding device applications and the like is provided only for your convenience and may be superseded by updates. It is your responsibility to ensure that your application meets with your specifications. MICROCHIP MAKES NO REPRESENTATIONS OR WARRANTIES OF ANY KIND WHETHER EXPRESS OR IMPLIED, WRITTEN OR ORAL, STATUTORY OR OTHERWISE, RELATED TO THE INFORMATION, INCLUDING BUT NOT LIMITED TO ITS CONDITION, QUALITY, PERFORMANCE, MERCHANTABILITY OR FITNESS FOR PURPOSE. Microchip disclaims all liability arising from this information and its use. Use of Microchip's products as critical components in life support systems is not authorized except with express written approval by Microchip. No licenses are conveyed, implicitly or otherwise, under any Microchip intellectual property rights.

Trademarks

The Microchip name and logo, the Microchip logo, Accuron, dsPIC, KEELOQ, microID, MPLAB, PIC, PICmicro, PICSTART, PRO MATE, PowerSmart, rfPIC, and SmartShunt are registered trademarks of Microchip Technology Incorporated in the U.S.A. and other countries.

AmpLab, FilterLab, Migratable Memory, MXDEV, MXLAB, PICMASTER, SEEVAL, SmartSensor and The Embedded Control Solutions Company are registered trademarks of Microchip Technology Incorporated in the U.S.A.

Analog-for-the-Digital Age, Application Maestro, dsPICDEM, dsPICDEM.net, dsPICworks, ECAN, ECONOMONITOR, FanSense, FlexROM, fuzzyLAB, In-Circuit Serial Programming, ICSP, ICEPIC, Linear Active Thermistor, MPASM, MPLIB, MPLINK, MPSIM, PICKit, PICDEM, PICDEM.net, PICLAB, PICTail, PowerCal, PowerInfo, PowerMate, PowerTool, Real ICE, rFLAB, rfPICDEM, Select Mode, Smart Serial, SmartTel, Total Endurance, UNI/O, WiperLock and Zena are trademarks of Microchip Technology Incorporated in the U.S.A. and other countries.

SQTP is a service mark of Microchip Technology Incorporated in the U.S.A.

All other trademarks mentioned herein are property of their respective companies.

© 2005, Microchip Technology Incorporated, Printed in the U.S.A., All Rights Reserved.

 Printed on recycled paper.

QUALITY MANAGEMENT SYSTEM
CERTIFIED BY DNV
== ISO/TS 16949:2002 ==

Microchip received ISO/TS-16949:2002 quality system certification for its worldwide headquarters, design and wafer fabrication facilities in Chandler and Tempe, Arizona and Mountain View, California in October 2003. The Company's quality system processes and procedures are for its PICmicro® 8-bit MCUs, KEELOQ® code hopping devices, Serial EEPROMs, microperipherals, nonvolatile memory and analog products. In addition, Microchip's quality system for the design and manufacture of development systems is ISO 9001:2000 certified.



MCP73831 EVALUATION BOARD USER'S GUIDE

Table of Contents

Preface	1
Introduction.....	1
Document Layout	1
Conventions Used in this Guide	2
Recommended Reading.....	3
The Microchip Web Site	3
Customer Support	4
Document Revision History	4
Chapter 1. Product Overview	
1.1 Introduction	5
1.2 What is the MCP73831 Evaluation Board?	6
1.3 What the MCP73831 Evaluation Kit Includes	6
Chapter 2. Installation and Operation	
2.1 Introduction	7
2.2 Features	7
2.3 Getting Started	8
Appendix A. Schematic and Layouts	
A.1 Introduction	11
Appendix B. Bill Of Materials (BOM)	
Worldwide Sales and Service	18

MCP73831 Evaluation Board User's Guide

NOTES:

Preface

NOTICE TO CUSTOMERS

All documentation becomes dated, and this manual is no exception. Microchip tools and documentation are constantly evolving to meet customer needs, so some actual dialogs and/or tool descriptions may differ from those in this document. Please refer to our web site (www.microchip.com) to obtain the latest documentation available.

Documents are identified with a “DS” number. This number is located on the bottom of each page, in front of the page number. The numbering convention for the DS number is “DSXXXXA”, where “XXXX” is the document number and “A” is the revision level of the document.

INTRODUCTION

This chapter contains general information that will be useful to know before using the MCP73831 Evaluation Board. Items discussed in this chapter include:

- Document Layout
- Conventions Used in this Guide
- Recommended Reading
- The Microchip Web Site
- Customer Support
- Document Revision History

DOCUMENT LAYOUT

This document describes how to use the MCP73831 Evaluation Board. The manual layout is as follows:

- **Chapter 1. “Product Overview”** – Important information about the MCP73831 Evaluation Board.
- **Chapter 2. “Installation and Operation”** – Includes instructions on how to get started with this evaluation kit and a description of the evaluation boards.
- **Appendix A. “Schematic and Layouts”** – Shows the schematic and layout diagrams for the MCP73831 Evaluation Board.
- **Appendix B. “Bill Of Materials (BOM)”** – Lists the parts used to build the MCP73831 Evaluation Board.

MCP73831 Evaluation Board User's Guide

CONVENTIONS USED IN THIS GUIDE

This manual uses the following documentation conventions:

DOCUMENTATION CONVENTIONS

Description	Represents	Examples
Arial font:		
Italic characters	Referenced books	<i>MPLAB[®] IDE User's Guide</i>
	Emphasized text	...is the <i>only</i> compiler...
Initial caps	A window	the Output window
	A dialog	the Settings dialog
	A menu selection	select Enable Programmer
Quotes	A field name in a window or dialog	"Save project before build"
Underlined, italic text with right angle bracket	A menu path	<u><i>File>Save</i></u>
Bold characters	A dialog button	Click OK
	A tab	Click the Power tab
N'Rnnnn	A number in verilog format, where N is the total number of digits, R is the radix and n is a digit.	4'b0010, 2'hF1
Text in angle brackets < >	A key on the keyboard	Press <Enter>, <F1>
Courier New font:		
Plain Courier New	Sample source code	#define START
	Filenames	autoexec.bat
	File paths	c:\mcc18\h
	Keywords	_asm, _endasm, static
	Command-line options	-Opa+, -Opa-
	Bit values	0, 1
	Constants	0xFF, 'A'
Italic Courier New	A variable argument	<i>file.o</i> , where <i>file</i> can be any valid filename
Square brackets []	Optional arguments	mcc18 [options] <i>file</i> [options]
Curly brackets and pipe character: { }	Choice of mutually exclusive arguments; an OR selection	errorlevel {0 1}
Ellipses...	Replaces repeated text	var_name [, var_name...]
	Represents code supplied by user	void main (void) { ... }

RECOMMENDED READING

This user's guide describes how to use the MCP73831 Evaluation Board. The following Microchip documents are available and recommended as supplemental reference resources.

MCP73831 Data Sheet, “Miniature Single-Cell, Fully-Integrated Li-Ion, Li-Polymer Charge-Management Controller”, (DS21984)

This data sheet provides detailed information regarding the MCP73831 product family.

AN947, “Power Management in Portable Applications: Charging Lithium-Ion/Lithium-Polymer Batteries”, (DS00947)

This application note provides general information regarding charging Li-Ion batteries.

AN971, “USB Port-Powered Li-Ion/Li-Polymer Battery Charging”, (DS00971)

This application note provides general information regarding charging Li-Ion batteries from a USB port.

THE MICROCHIP WEB SITE

Microchip provides online support via our web site at www.microchip.com. This web site is used as a means to make files and information easily available to customers. Accessible by using your favorite Internet browser, the web site contains the following information:

- **Product Support** – Data sheets and errata, application notes and sample programs, design resources, user's guides and hardware support documents, latest software releases and archived software
- **General Technical Support** – Frequently Asked Questions (FAQs), technical support requests, online discussion groups, Microchip consultant program member listing
- **Business of Microchip** – Product selector and ordering guides, latest Microchip press releases, listing of seminars and events, listings of Microchip sales offices, distributors and factory representatives

MCP73831 Evaluation Board User's Guide

CUSTOMER SUPPORT

Users of Microchip products can receive assistance through several channels:

- Distributor or Representative
- Local Sales Office
- Field Application Engineer (FAE)
- Technical Support
- Development Systems Information Line

Customers should contact their distributor, representative or field application engineer (FAE) for support. Local sales offices are also available to help customers. A listing of sales offices and locations is included in the back of this document.

Technical support is available through the web site at: <http://support.microchip.com>

DOCUMENT REVISION HISTORY

Revision A (December 2005)

- Initial Release of this Document.

Chapter 1. Product Overview

1.1 INTRODUCTION

The MCP73831 Evaluation Board is used to evaluate Microchip's MCP73831 in simple, stand-alone Li-Ion battery charging applications. Two circuit boards are provided in the MCP73831 Evaluation Kit for evaluation of various device options.

This chapter covers the following topics:

- What is the MCP73831 Evaluation Board?
- What the MCP73831 Evaluation Kit Includes

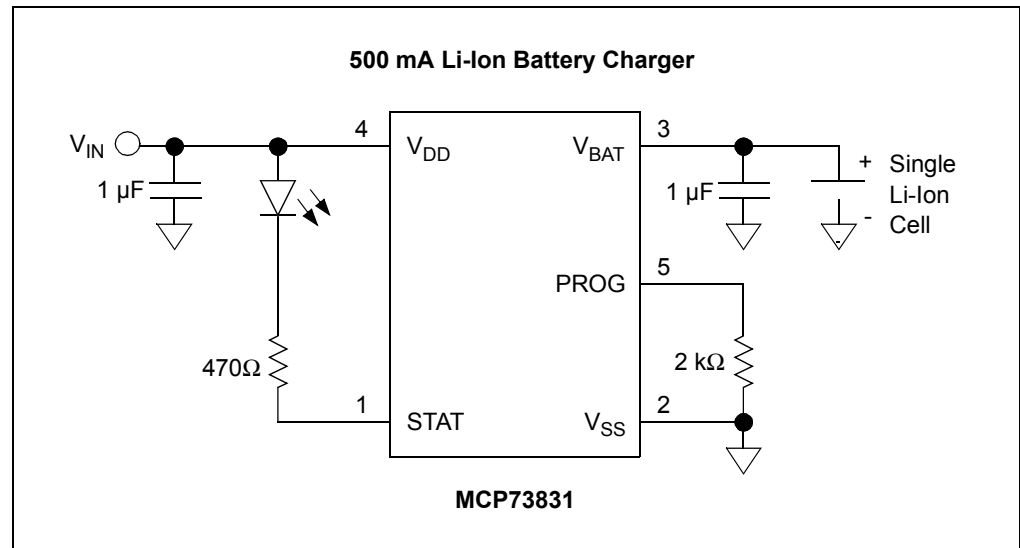

FIGURE 1-1: Typical MCP73831 Application.

MCP73831 Evaluation Board User's Guide

1.2 WHAT IS THE MCP73831 EVALUATION BOARD?

The MCP73831 Evaluation Board is an evaluation and demonstration tool for Microchip's MCP73831 miniature single-cell, fully-integrated Li-Ion, Li-Polymer charge-management controllers.

Two evaluation boards are provided in the MCP73831 Evaluation Kit. The boards are set up to evaluate simple, stand-alone, linear charging of single-cell Li-Ion / Li-Polymer battery packs (the battery packs are not included). Each board design provides constant current charging followed by constant voltage charging with automatic charge termination. In addition, the MCP73831-2AC board provides preconditioning of deeply depleted cells.

Each board design provides evaluation of the MCP73831 in two package options: a SOT23-5 and a 2 mm x 3 mm, 8-Lead DFN for higher power handling capability.

When connected, these evaluation boards allow for the evaluation of the MCP73831 devices in a variety of applications.

1.3 WHAT THE MCP73831 EVALUATION KIT INCLUDES

This MCP73831 Evaluation Kit includes:

- Two MCP73831 Evaluation Boards, 102-00085
- MCP73831 Evaluation Board User's Guide, DS51596
- MCP73831 Data Sheet, "*Miniature Single-Cell, Fully-Integrated Li-Ion, Li-Polymer Charge-Management Controller*", DS21984
- AN947, "*Power Management in Portable Applications: Charging Lithium-Ion/Lithium-Polymer Batteries*", DS00947
- AN971, "*USB Port-Powered Li-Ion/Li-Polymer Battery Charging*", DS00971

Chapter 2. Installation and Operation

2.1 INTRODUCTION

The MCP73831 Evaluation Board demonstrates Microchip's MCP73831. The MCP73831 is a miniature single-cell, fully-integrated Li-Ion/Li-Polymer charge-management controller. A number of device options allow the MCP73831 to be utilized in a variety of applications. Refer to the MCP73831 data sheet (DS21984) for device options.

2.2 FEATURES

The MCP73831 Evaluation Kit contains two boards for evaluation of various device options. The boards have the following features with the factory installed devices:

- Charge Voltage: 4.20V
- Programmable Fast Charge Current up to 500 mA
- Preconditioning of deeply depleted cells (MCP73831-2AC)
 - Preconditioning Threshold Voltage: 2.8V
 - Preconditioning Current: 10% of Programmed Fast Charge Current
- No Preconditioning (MCP73831-2DC)
- Automatic Charge Termination
 - Charge termination by minimum current in Constant Voltage Mode
 - Termination Current: 7.5% of Programmed Fast Charge Current
- Automatic Recharge
 - Recharge Threshold Voltage: 4.05V
- Charge Current Monitor for Fuel Gauging
- Thermal Regulation
- Reverse Discharge Protection
- Evaluation in SOT23-5 Package
- Evaluation in 2 mm x 3 mm, 8-Lead DFN package for higher power handling capability
- Simple Stand-Alone Operation
- Powered from external bench supply or voltage regulated wall cube
- Surface-Mount Design
- Fully Assembled and Tested

MCP73831 Evaluation Board User's Guide

2.3 GETTING STARTED

The MCP73831 Evaluation Boards are fully assembled and tested for charging single-cell, Li-Ion/Li-Polymer battery packs. The boards provide the appropriate charge algorithm for simple, stand-alone operation.

The boards require the use of an external input voltage source ($5V \pm 10\%$, recommended) and external load (battery pack or simulated battery load).

2.3.1 Power Input and Output Connections

2.3.1.1 POWERING A MCP73831 EVALUATION BOARD

1. Apply the input voltage source to the appropriate circuit for evaluation. The input voltage source should be limited to the 0V to +6V range. For normal operation, the input voltage should be between +4.5V and +6V. The input voltage must not exceed an absolute maximum of +7V.
2. Connect the positive side of the input source (+) to V_{DD} of the circuit being evaluated. Connect the negative or return side of the input source (-) to V_{SS} of the circuit being evaluated. Refer to Figure 2-1.

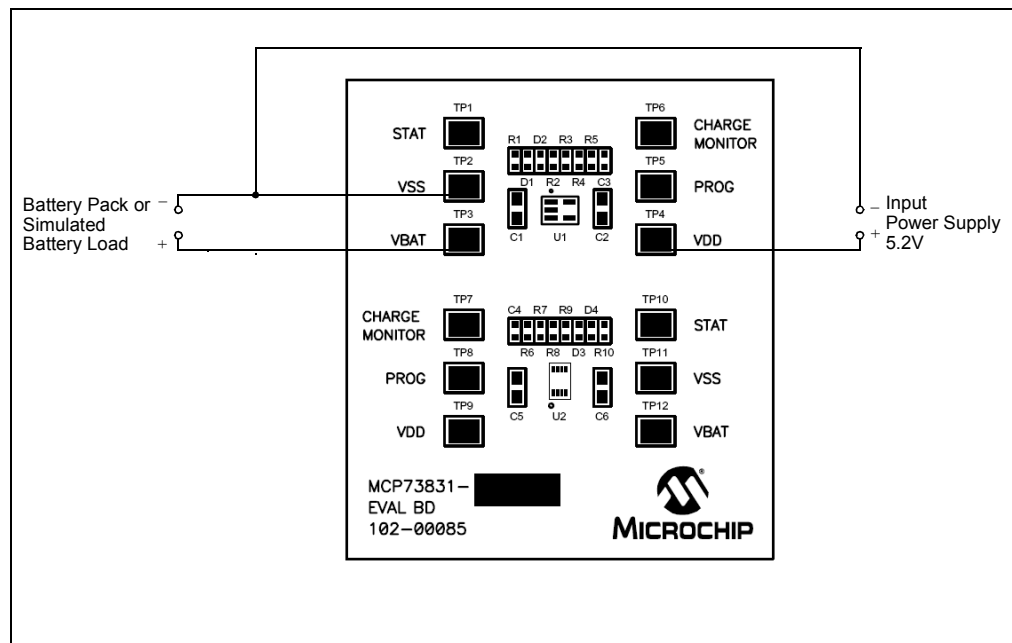

FIGURE 2-1: Setup Configuration Diagram.

2.3.1.2 APPLYING THE LOAD TO A MCP73831 EVALUATION BOARD

1. To apply a load to a MCP73831 Evaluation Board, the positive side of the load (B+) should be connected to V_{BAT} of the circuit being evaluated. The negative or return side of the load (B-) should be connected to V_{SS} of the circuit being evaluated. Care should be taken when using electronic loads or ground referenced loads.
2. For the MCP73831-2AC board, the charge management controller will only provide 10% of the programmed fast charge current if the battery terminal voltage (V_{BAT}) is less than 2.8V with respect to V_{SS} . Using a purely resistive load will not work for preconditioning and fast charge currents. The best way to evaluate the charge management circuit is to use a single-cell Li-Ion battery pack, or the recommended simulated battery load. Refer to Figure 2-2.

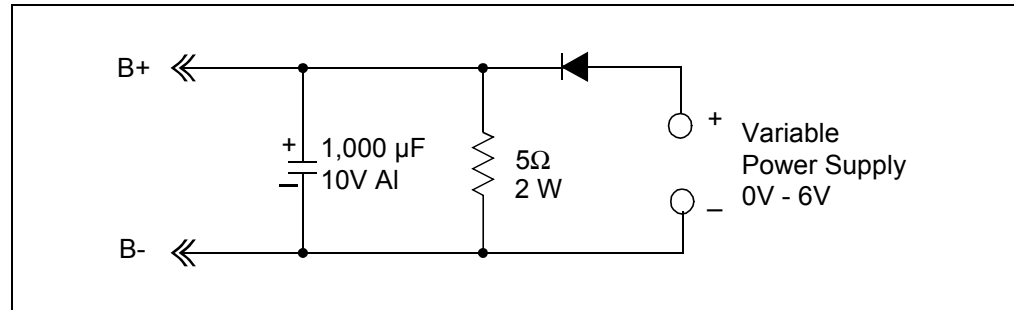

FIGURE 2-2: Simulated Battery Load.

2.3.1.3 SETTING THE FAST CHARGE CURRENT

1. As provided, the MCP73831 Evaluation Boards have two fast charge current settings: 100 mA and 500 mA. The default fast charge current setting is 100 mA. By jumpering PROG to V_{SS} of the circuit being evaluated, the fast charge current is set to 500 mA.
2. Alternatively, the appropriate programming resistor can be changed in the hardware to obtain the desired fast charge current setting. Resistor R3 should be changed for the SOT23 circuit, and resistor R8 should be changed for the DFN circuit. Refer to the MCP73831 data sheet for choosing the appropriate value programming resistor for the desired fast charge current.

2.3.1.4 STATUS INDICATORS

1. The MCP73831 Evaluation Boards have two LED status indicators for each circuit being evaluated. Table 2-1 represents the state of the status indicators during various states of the charge cycle. ON indicates that the respective LED is illuminated.

TABLE 2-1: STATUS INDICATORS

Charge Cycle State	Red LED	Green LED
Qualification	ON	ON
Preconditioning	ON	OFF
Constant Current Fast Charge	ON	OFF
Constant Voltage	ON	OFF
Charge Complete	OFF	ON
Battery Disconnected	ON	ON
Input Voltage Source Removed	OFF	OFF
Input Voltage Source Below UVLO	ON	ON
Shutdown	ON	ON

2.3.1.5 CHARGE CURRENT MONITOR

1. The MCP73831 Evaluation Boards have a charge current monitor for each circuit being evaluated. The charge current monitor can be used as a coulomb counter for fuel gauging. The charge current is equivalent to the voltage at CHARGE MONITOR with respect to V_{SS} divided by the value of the programming resistor in kilo-ohms. For example, the default programming resistor is 10 k Ω . If the measured voltage at CHARGE MONITOR is 1V, the charge current is equal to 1 divided 10, or 100 mA. If the measured voltage at CHARGE MONITOR is 100 mV, the charge current is 0.1 divided by 10, or 10 mA.

MCP73831 Evaluation Board User's Guide

2.3.1.6 DEVICE SUPPORT OPTIONS

1. The MCP73831 Evaluation Boards are capable of supporting all of the available MCP73831 device options. The factory installed devices are the MCP73831-2AC and the MCP73831-2DC. Refer to the MCP73831 data sheet for available device options and details regarding the installed device options.



MCP73831 EVALUATION BOARD USER'S GUIDE

Appendix A. Schematic and Layouts

A.1 INTRODUCTION

This appendix contains the following schematic and layouts for the MCP73831 Evaluation Boards.

Diagrams included in this appendix:

- Board Schematic
- Board - Assembly Drawing
- Board - Top Overlay
- Board - Top Layer
- Board - Bottom Layer

MCP73831 Evaluation Board User's Guide

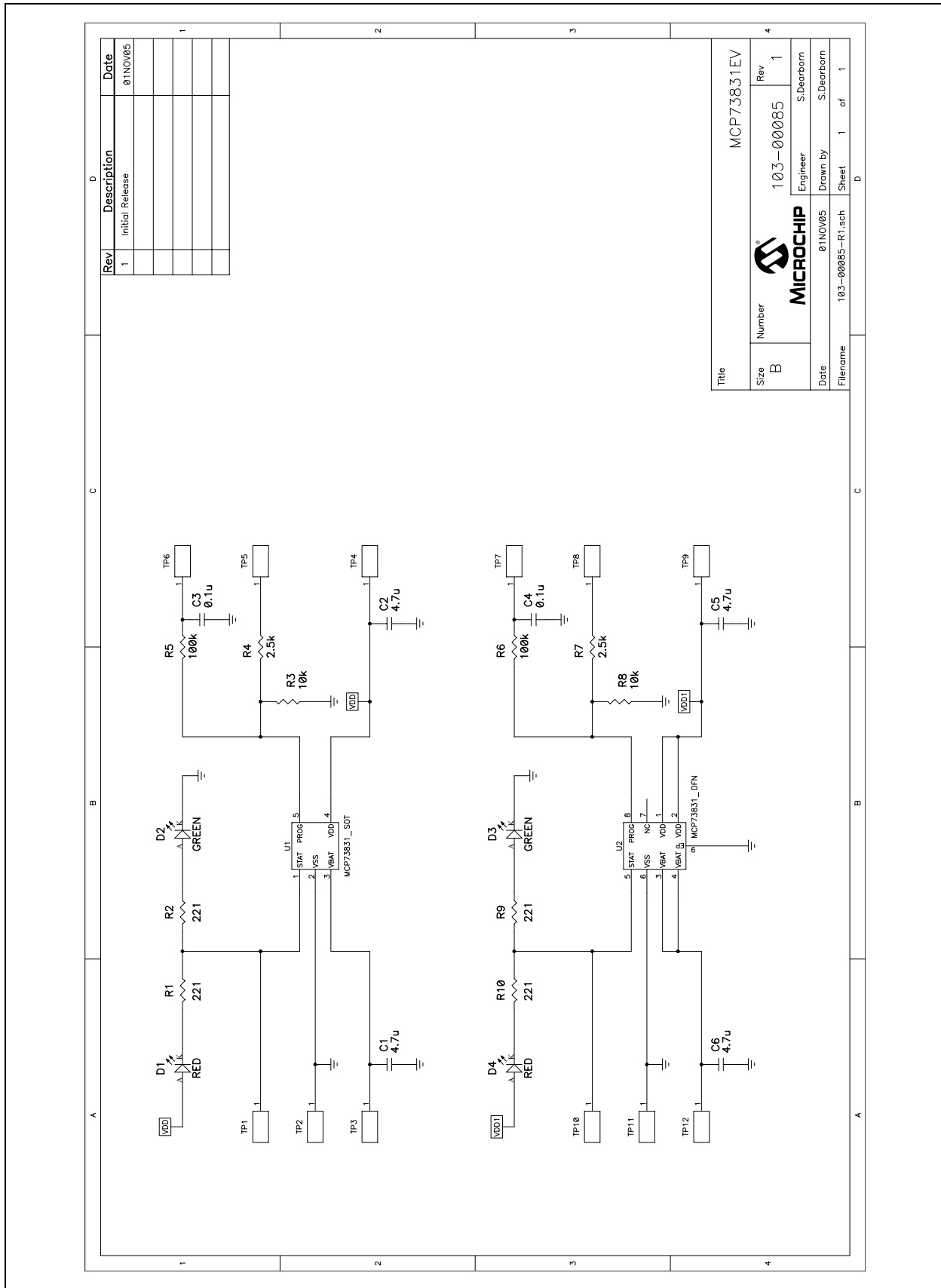

FIGURE A-1: Board Schematic.

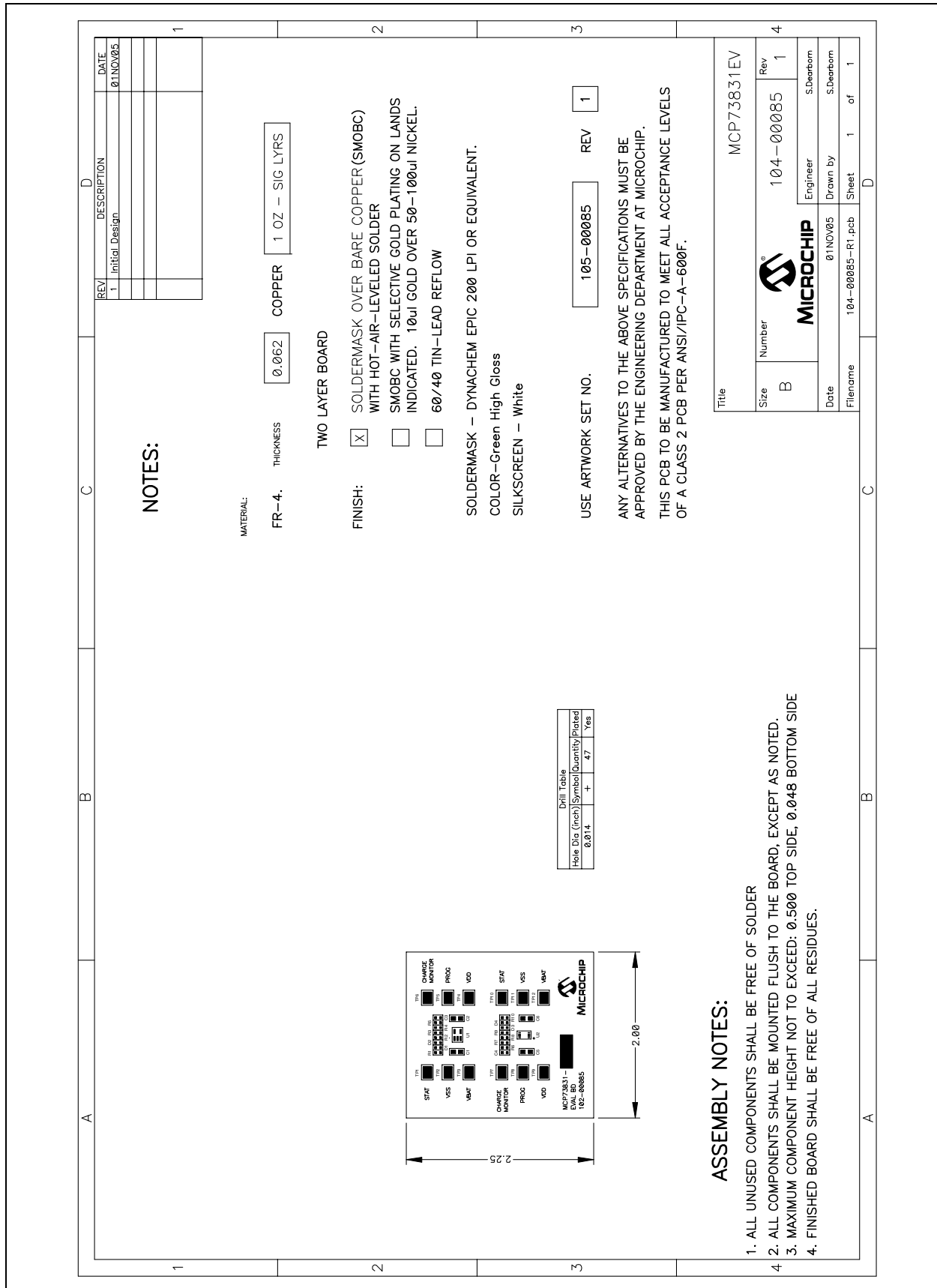

FIGURE A-2: Board - Assembly Drawing.

MCP73831 Evaluation Board User's Guide

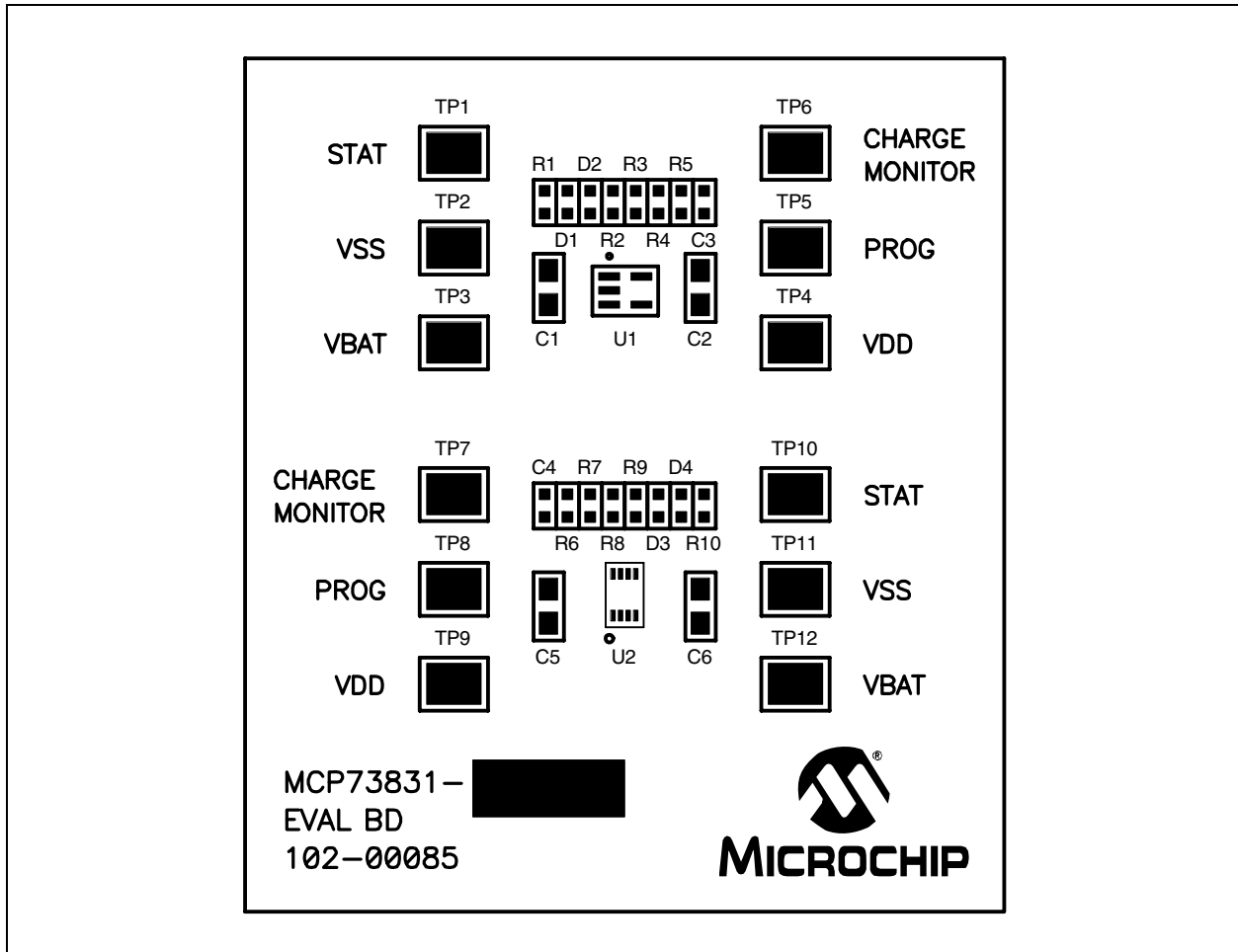

FIGURE A-3: Board - Top Overlay.

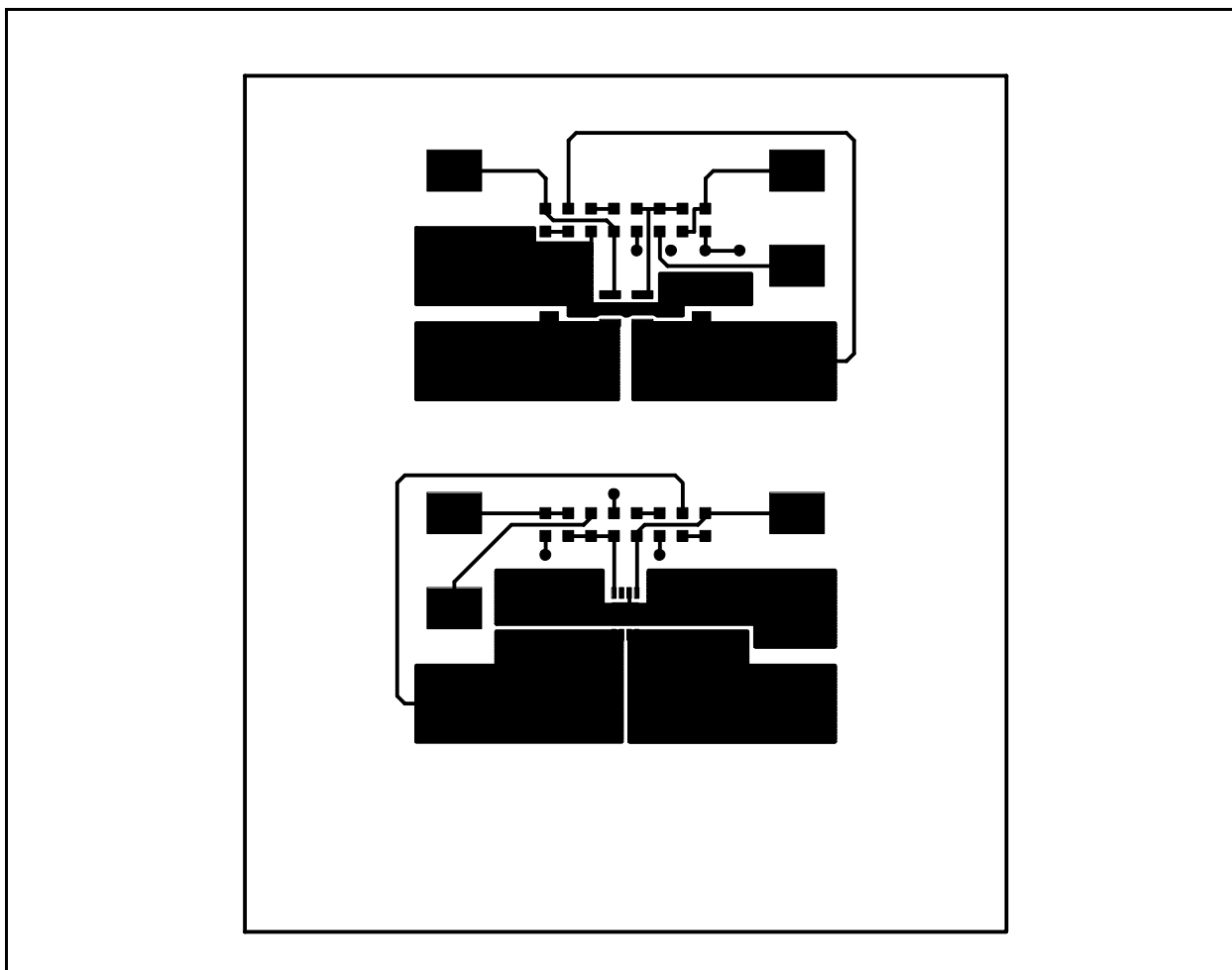

FIGURE A-4: Board - Top Layer.

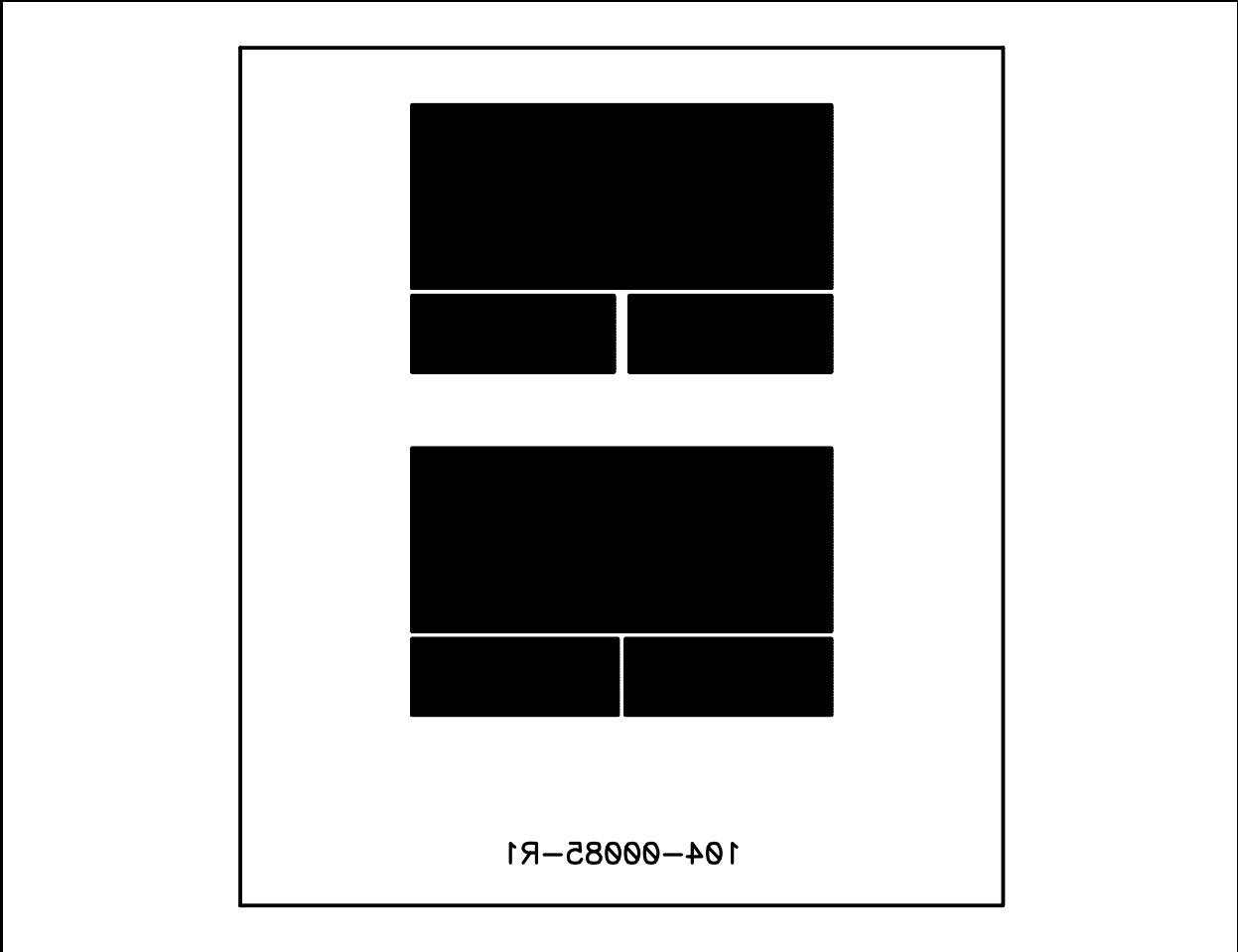

FIGURE A-5: Board - Bottom Layer.

Appendix B. Bill Of Materials (BOM)

TABLE B-1: BILL OF MATERIALS (BOM)

Qty.	Reference	Description	Mfgr.	Part Number
4	C1,C2,C5,C6	4.7uF, X5R Ceramic, 10V, 0805	Panasonic®-ECG	ECJ-GVB1A475M
2	C3,C4	0.1uF, X7R Ceramic, 16V, 0603	Panasonic-ECG	ECJ-1VB1C104K
2	D1,D4	Super Red LED, 0603	Lumex	LTST-C190KRKT
2	D2,D3	Green LED, 0603	Lumex	LTST-C190KGKT
4	R1,R2,R9,R10	221, 1/10W, Chip Resistor, 0603	Panasonic-ECG	ERJ-3EK2210V
2	R3,R8	10.0k, 1/10W, Chip Resistor, 0603	Panasonic-ECG	ERJ-3EK1002V
2	R4,R7	2.49k, 1/10W, Chip Resistor, 0603	Panasonic-ECG	ERJ-3EK2491V
2	R5,R6	100k, 1/10W, Chip Resistor, 0603	Panasonic-ECG	ERJ-3EK1003V
12	TP1-TP12	Surface Mount Test Point, 5016	Keystone	5016
1	U1	Miniature Li-Ion Charger, SOT23-5	Microchip Technology Inc.	MCP73831-2ACI/OT MCP73831-2DCI/OT (1)
1	U2	Miniature Li-Ion Charger, 2X3DFN8	Microchip Technology Inc.	MCP73831-2ACI/MC MCP73831-2DCI/MC (1)
4		Bump-ons	3M	SJ5003
1		Printed Circuit Board	Advanced Circuits	104-00085-R1

Note 1: Installed device option is indicated on board.



WORLDWIDE SALES AND SERVICE

AMERICAS

Corporate Office
2355 West Chandler Blvd.
Chandler, AZ 85224-6199
Tel: 480-792-7200
Fax: 480-792-7277
Technical Support:
<http://support.microchip.com>
Web Address:
www.microchip.com

Atlanta

Alpharetta, GA
Tel: 770-640-0034
Fax: 770-640-0307

Boston

Westborough, MA
Tel: 774-760-0087
Fax: 774-760-0088

Chicago

Itasca, IL
Tel: 630-285-0071
Fax: 630-285-0075

Dallas

Addison, TX
Tel: 972-818-7423
Fax: 972-818-2924

Detroit

Farmington Hills, MI
Tel: 248-538-2250
Fax: 248-538-2260

Kokomo

Kokomo, IN
Tel: 765-864-8360
Fax: 765-864-8387

Los Angeles

Mission Viejo, CA
Tel: 949-462-9523
Fax: 949-462-9608

San Jose

Mountain View, CA
Tel: 650-215-1444
Fax: 650-961-0286

Toronto

Mississauga, Ontario,
Canada
Tel: 905-673-0699
Fax: 905-673-6509

ASIA/PACIFIC

Australia - Sydney
Tel: 61-2-9868-6733
Fax: 61-2-9868-6755

China - Beijing
Tel: 86-10-8528-2100
Fax: 86-10-8528-2104

China - Chengdu
Tel: 86-28-8676-6200
Fax: 86-28-8676-6599

China - Fuzhou
Tel: 86-591-8750-3506
Fax: 86-591-8750-3521

China - Hong Kong SAR
Tel: 852-2401-1200
Fax: 852-2401-3431

China - Qingdao
Tel: 86-532-8502-7355
Fax: 86-532-8502-7205

China - Shanghai
Tel: 86-21-5407-5533
Fax: 86-21-5407-5066

China - Shenyang
Tel: 86-24-2334-2829
Fax: 86-24-2334-2393

China - Shenzhen
Tel: 86-755-8203-2660
Fax: 86-755-8203-1760

China - Shunde
Tel: 86-757-2839-5507
Fax: 86-757-2839-5571

China - Wuhan
Tel: 86-27-5980-5300
Fax: 86-27-5980-5118

China - Xian
Tel: 86-29-8833-7250
Fax: 86-29-8833-7256

ASIA/PACIFIC

India - Bangalore
Tel: 91-80-2229-0061
Fax: 91-80-2229-0062

India - New Delhi
Tel: 91-11-5160-8631
Fax: 91-11-5160-8632

India - Pune
Tel: 91-20-2566-1512
Fax: 91-20-2566-1513

Japan - Yokohama
Tel: 81-45-471-6166
Fax: 81-45-471-6122

Korea - Gumi
Tel: 82-54-473-4301
Fax: 82-54-473-4302

Korea - Seoul
Tel: 82-2-554-7200
Fax: 82-2-558-5932 or
82-2-558-5934

Malaysia - Penang
Tel: 60-4-646-8870
Fax: 60-4-646-5086

Philippines - Manila
Tel: 63-2-634-9065
Fax: 63-2-634-9069

Singapore
Tel: 65-6334-8870
Fax: 65-6334-8850

Taiwan - Hsin Chu
Tel: 886-3-572-9526
Fax: 886-3-572-6459

Taiwan - Kaohsiung
Tel: 886-7-536-4818
Fax: 886-7-536-4803

Taiwan - Taipei
Tel: 886-2-2500-6610
Fax: 886-2-2508-0102

Thailand - Bangkok
Tel: 66-2-694-1351
Fax: 66-2-694-1350

EUROPE

Austria - Wels
Tel: 43-7242-2244-399
Fax: 43-7242-2244-393

Denmark - Copenhagen
Tel: 45-4450-2828
Fax: 45-4485-2829

France - Paris
Tel: 33-1-69-53-63-20
Fax: 33-1-69-30-90-79

Germany - Munich
Tel: 49-89-627-144-0
Fax: 49-89-627-144-44

Italy - Milan
Tel: 39-0331-742611
Fax: 39-0331-466781

Netherlands - Drunen
Tel: 31-416-690399
Fax: 31-416-690340

Spain - Madrid
Tel: 34-91-708-08-90
Fax: 34-91-708-08-91

UK - Wokingham
Tel: 44-118-921-5869
Fax: 44-118-921-5820

Компания «Океан Электроники» предлагает заключение долгосрочных отношений при поставках импортных электронных компонентов на взаимовыгодных условиях!

Наши преимущества:

- Поставка оригинальных импортных электронных компонентов напрямую с производств Америки, Европы и Азии, а так же с крупнейших складов мира;
- Широкая линейка поставок активных и пассивных импортных электронных компонентов (более 30 млн. наименований);
- Поставка сложных, дефицитных, либо снятых с производства позиций;
- Оперативные сроки поставки под заказ (от 5 рабочих дней);
- Экспресс доставка в любую точку России;
- Помощь Конструкторского Отдела и консультации квалифицированных инженеров;
- Техническая поддержка проекта, помощь в подборе аналогов, поставка прототипов;
- Поставка электронных компонентов под контролем ВП;
- Система менеджмента качества сертифицирована по Международному стандарту ISO 9001;
- При необходимости вся продукция военного и аэрокосмического назначения проходит испытания и сертификацию в лаборатории (по согласованию с заказчиком);
- Поставка специализированных компонентов военного и аэрокосмического уровня качества (Xilinx, Altera, Analog Devices, Intersil, Interpoint, Microsemi, Actel, Aeroflex, Peregrine, VPT, Syfer, Eurofarad, Texas Instruments, MS Kennedy, Miteq, Cobham, E2V, MA-COM, Hittite, Mini-Circuits, General Dynamics и др.);

Компания «Океан Электроники» является официальным дистрибьютором и эксклюзивным представителем в России одного из крупнейших производителей разъемов военного и аэрокосмического назначения «JONHON», а так же официальным дистрибьютором и эксклюзивным представителем в России производителя высокотехнологичных и надежных решений для передачи СВЧ сигналов «FORSTAR».



JONHON

«JONHON» (основан в 1970 г.)

Разъемы специального, военного и аэрокосмического назначения:

(Применяются в военной, авиационной, аэрокосмической, морской, железнодорожной, горно- и нефтедобывающей отраслях промышленности)

«FORSTAR» (основан в 1998 г.)

ВЧ соединители, коаксиальные кабели, кабельные сборки и микроволновые компоненты:

(Применяются в телекоммуникациях гражданского и специального назначения, в средствах связи, РЛС, а так же военной, авиационной и аэрокосмической отраслях промышленности).



Телефон: 8 (812) 309-75-97 (многоканальный)

Факс: 8 (812) 320-03-32

Электронная почта: ocean@oceanchips.ru

Web: <http://oceanchips.ru/>

Адрес: 198099, г. Санкт-Петербург, ул. Калинина, д. 2, корп. 4, лит. А