

**SERIES 08**  
**SERIES 09**  
**0.5" Diameter, 1/4 Amp,**  
**Standard, Military SR13**

**FEATURES**

- Proven Quality in Thousands of Applications
- Gold-plated Contact System
- 30°, 36°, 45°, 60° and 90° Angle of Throw Options
- MIL Qualified Versions MIL-S-3786/13



**DIMENSIONS** in inches (and millimeters)

**Standard Style**

Front view shows terminal location of Series 8, 36° angle of throw. Transpose rear view for terminal location of other angles of throw.

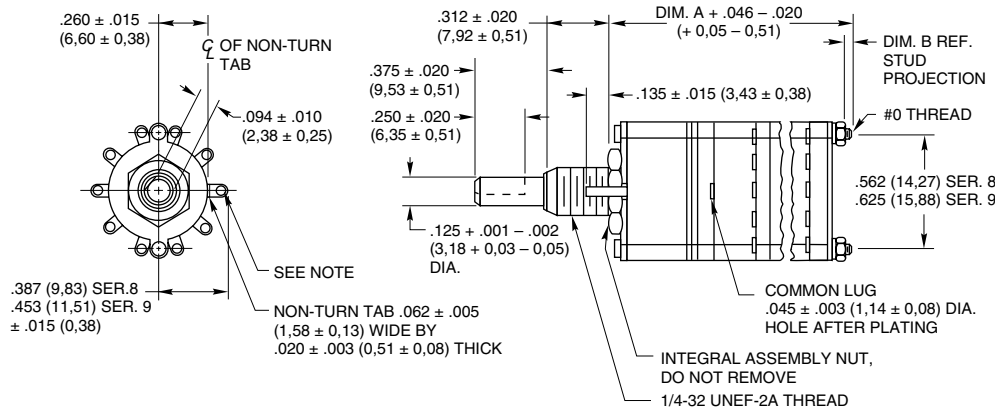

**Note:** Common location for a single pole per deck switch. For common location on multi-pole switches, see circuit diagrams.

No. of Decks	Dimension A	Dimension B	Approx. Weight Grams		No. of Decks	Dimension A	Dimension B	Approx. Weight Grams	
			Srs. 08	Srs. 09				Srs. 08	Srs. 09
1	.960 (24,38)	.062 (1,57)	12	16.0	7	2.818 (71,58)	.312 (7,92)	24	31.0
2	1.228 (31,19)	.062 (1,57)	14	18.5	8	3.086 (78,38)	.312 (7,92)	26	33.5
3	1.496 (38,00)	.062 (1,57)	16	21.0	9	3.354 (85,19)	.312 (7,92)	28	36.0
4	1.764 (44,81)	.062 (1,57)	18	23.5	10	3.622 (91,00)	.312 (7,92)	30	38.5
5	2.032 (51,61)	.062 (1,57)	20	26.0	11	3.890 (98,81)	.312 (7,92)	32	41.0
6	2.550 (64,77)	.312 (7,92)	22	28.5	12	4.158 (105,61)	.312 (7,92)	34	43.5

Grayhill part number and date code marked on standard style detent cover label. Customer part number marked on request. Grayhill part number and date code printed on military style cover. Military number printed when required.

**Rear Views**

**Series 09**  
**30° Angle of Throw**

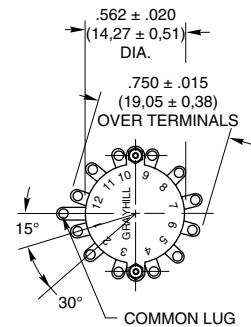

**Series 08**  
**36° Angle of Throw**

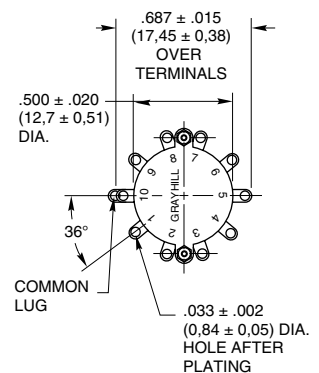

For rear view of 45°, 60° and 90°, see circuit diagrams.

**CIRCUIT DIAGRAMS: Solder Lug Terminals**

**Switch is Viewed From Shaft End and Shown in Position No. 1**

Note: All common terminals are located above base terminals as shown.

**Series 09  
30° Angle  
of Throw**



**Series 08  
36° Angle  
of Throw**

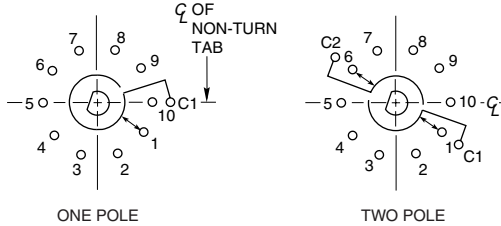

**Series 09  
45° Angle  
of Throw**

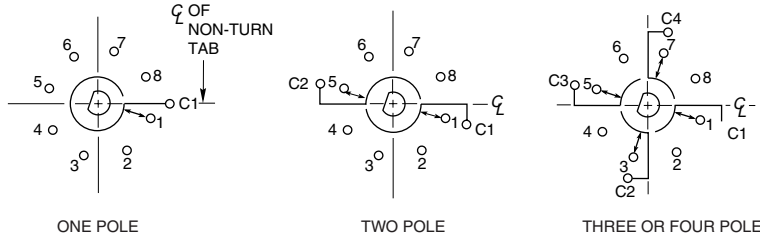

**Series 09  
60° Angle  
of Throw**

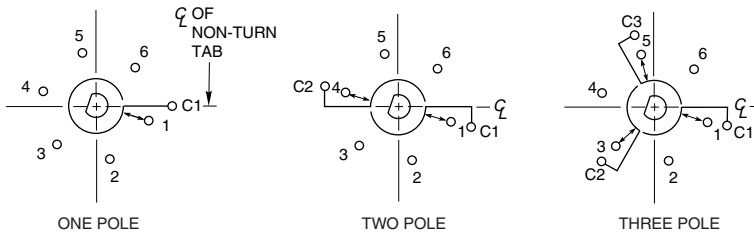

**Series 09  
90° Angle  
of Throw**

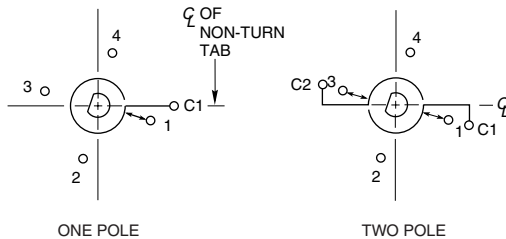

**Rear Views**

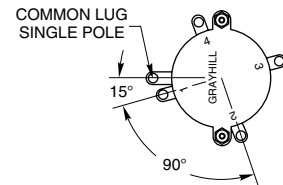
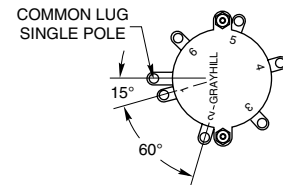

**SERIES 08**  
**SERIES 09**  
**.5" Diameter, 1/4 Amp, PC Mount**

**FEATURES**

- Gold-plated Contact System
- 30°, 36°, 60° or 90° Angle of Throw Options
- Compatible with Logic Level Voltages and Currents



**DIMENSIONS** in inches (and millimeters)

**PC Mount Style**

Front view shows terminal location of 36° angle of throw. Transpose rear view for terminal location of 30° angle of throw. See Circuit Diagrams for 60° and 90° angles of throw.

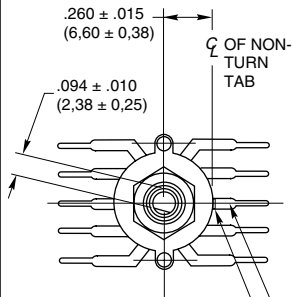

NON-TURN TAB .062 ± .005  
 (1,58 ± 0,13) WIDE BY  
 .020 ± .003 (0,51 ± 0,08) THICK

SEE NOTE

**Note:** Common location for a single pole per deck switch. For common location on multi-pole switches, see circuit diagrams.

**\*Termination**

A standard switch uses the entire 360° of each deck as required by the circuitry. Thus one-sided termination is standard for Series 08, 36°, 1 pole switches with 1 to 5 positions per pole; it is also standard for Series 09, 30°, 1 pole switches with 1 to 6 positions per pole. Two-sided termination is standard for 1 pole switches with more positions per pole and for switches of 2 or more poles per deck.

Special switches with one-sided termination can be made for circuitry which would require two-sided termination in standard switches. Contact Grayhill for a special part number. See also Special Options, page J-10.

Grayhill part number and date code marked on detent cover label. Customer part number marked on request.

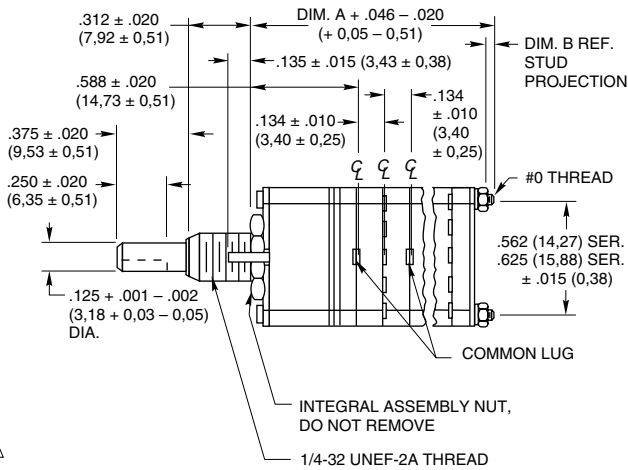

**Rear Views**

**Series 09**  
**30° Angle of Throw**

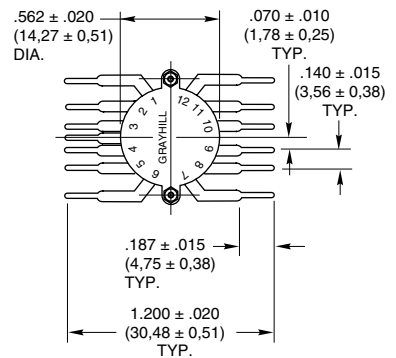

**Series 08**  
**36° Angle of Throw**

TERMINAL DIMENSIONS AT THIS POINT ARE .032 ± .000 - .010 (0,81 ± 0,00 - 0,25) WIDE BY .015 ± .000 - .003 (0,38 ± 0,00 - 0,08) THICK

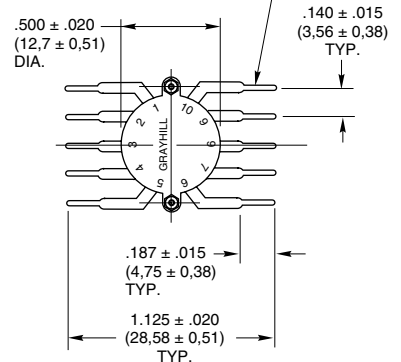

**CIRCUIT DIAGRAMS: PC Mount**



**PC BOARD MOUNTING PATTERN**



**SHAFT AND PANEL SEAL**

A shaft and panel seal is available to provide watertight mounting of the Series 08 and 09. Standard and Military Style rotary switches. Sealing is accomplished by O-ring shaft seal and panel seal washer. When the panel seal is compressed, dimensions are approximately the same as an unsealed switch. Sealed switches are provided with a double flat bushing. Non-turn feature can be accomplished by proper fit of this bushing into panel hole and/or by allowing non-turn tab to extend into (but not through) panel. Military Style rotary sealed switches do not have a non-turn tab.

Rotary Switches

## MILITARY QUALIFIED

Series 08 and 09 military switches are qualified to MIL-DTL-3786/13. They include 30°, 36°, 45° and 60° angles of throw with solder lug terminals in sealed and unsealed styles. See front and rear views at right. Standard variations which do not affect switch performance can also be marked as qualified product—contact Grayhill.

The military style is dimensionally the same as the standard except for the solder lug. Convert standard style switch drawings to military style drawings by including this terminal detail and changing the over-terminal dimensions shown here. Grayhill can provide complete specification drawings. Qualified switches can be ordered by the Grayhill number or the "M" number; they will be marked per MIL-DTL-3786/13.

Front view shows terminal location of Series 09, 30° angle of throw. Transpose rear view for terminal location of other angles of throw.



**Note:** Common location for a single pole per deck switch. For common location on multi-pole switches, see circuit diagrams.

**Series 09**  
30° Angle of Throw

**Series 08**  
36° Angle of Throw

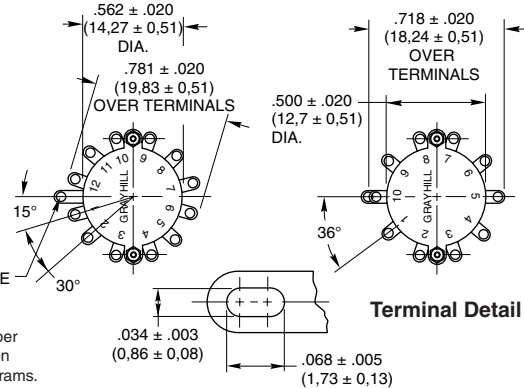

**Terminal Detail**

## SPECIFICATIONS

### Electrical Ratings

#### Standard Style

**Rated:** To make and break the following loads: 1/4 amp, 115 Vac resistive; 1/4 amp, 6-28 Vdc resistive; 20 mA, 115 Vdc resistive; 50 mA, 115 Vac inductive; 20 mA, 28 Vdc inductive; to carry 4 amps continuous.

**Contact Resistance:** After 25,000 cycles of operation, 50 milliohms maximum

**Insulation Resistance:** 1,000 megohms minimum between terminals and shaft

**Voltage Breakdown:** 1,000 Vac initially (500 Vac or better after most environmental tests)

**Life Expectancy:** 50,000 mechanical cycles of operation. *Note:* Actual life is determined by a number of factors, including electrical loading, rate of rotation and environment, as well as maximum contact resistance, minimum insulation resistance and minimum voltage breakdown required at the end of life.

### Electrical Ratings

#### Military Qualified

**Qualified to the following MIL-DTL-3786/13**

**Circuit Values:** (Also see Standard Style description.) The Series 08M and 09M have been tested to meet the requirements of MIL-S-3786, Style SR13, the majority of which are listed. At 85°C, approximately 68% relative humidity and sea level pressure, the switches have been tested to make and break the following loads, as stated in MIL-DTL-3786/SR13: 125 milliamperes at 28 Vdc resistive; 75 milliamperes at 115 Vac resistive.

The switches have also been tested at reduced barometric pressure (70,000 feet), 25°C at approximately 68% relative humidity to make and break the following loads as stated in MIL-DTL-3786/SR13. 50 milliamperes 28 Vdc resistive; 20 milliamperes 115 Vac resistive. When tested to the above loads at the stated conditions, the Series 08M and 09M switches meet the following life-limiting criteria after 25,000 cycles of operation in accordance with

MIL-DTL-3786.

**Contact Resistance:** 50 milliohms maximum after life

**Insulation Resistance:** 1,000 megohms minimum between terminals and shaft

**Dielectric Strength:** 500 Vac (atmospheric pressure) and 350 Vac (reduced pressure) between mutually insulated parts.

The Series 08M and 09M also meet the requirements of MIL-DTL-3786 SR13 for moisture resistance, stop strength, rotational torque, vibration (10 to 2,000 cps), medium and high shock, salt spray, explosion, thermal shock (-65°C to 85°C) and terminal pull. When tested at sea level, 25°C and 68% relative humidity with failure criteria of 50 milliohms maximum contact resistance and 500 Vac breakdown voltage, these switches will make and break 250 mA at 28 Vdc inductive (250 millihenries): 1/2 amp: at 28 Vdc resistive; 1/2 amp; at 115 Vac: 60 Hz resistive for 10,000 cycles of operation.

### Materials and Finishes

#### Standard Style

**Switch Bases:** Melamine per (MIL-M-14) ASTM-D-5948

**Cover, Deck Separators and End Plate:** Phenolic per (MIL-M-14) ASTM-D-5948

**Rotor Mounting Plate:** Thermoplastic

**Mounting Bushing:** Brass, tin/zinc-plated.

**Shaft, Retaining Rings, Through Bolts, Shaft Extension, Stop Washers, Stop Arm, Thrust Washers, Nuts, Cover Plate and Rear Support Plate:** Stainless steel

**Detent Balls:** Steel, nickel-plated

**Detent Springs:** Tinned Music wire

**Terminals, Stator (Base) Contacts and Common Plate:** Brass, gold plate .00001" minimum over silver plate .0003" minimum

**Rotor Contact:** Silver alloy, gold-plated .00001" minimum

**Mounting Hardware:** Two mounting nuts .062" (1.57) thick by .312" (7.92) across flats and one internal lockwasher are supplied with switch.

**Lockwasher:** Stainless steel

**Mounting Nuts, Washers:** Brass, tin/zinc-plated and or stainless steel.

### Materials and Finishes

#### Military Qualified

**Deck Separators, End Plate and Switch Bases:** Diallyl per (MIL-M-14) ASTM-D-5948

**Rotor Mounting Plate:** Thermoplastic

**Mounting Bushing:** Brass, tin/zinc-plated.

**Shaft, Cover, Stop Plate, Retaining Ring, Through Bolts, Shaft Extension, Stop Arm, Thrust Washers, Cover Plate and Rear Support Plate, Lockwashers and Nuts:** Stainless steel

**Detent Balls:** Steel, nickel-plated

**Detent Springs:** Tinned music wire

**Terminals, Stator (Base) Contacts and Common Plate:** Brass, gold plate .00001" minimum over silver plate .0003" minimum

**Rotor Contact:** Silver alloy, gold-plated .00001" minimum

**Mounting Hardware:** Two mounting nuts .062" (1.57) thick by .312" (7.92) across flats and one internal tooth lockwasher are supplied with this switch.

**Mounting Nuts, Washers:** Brass, tin/zinc-plated and or stainless steel.

**Mounting Nuts, Washers:** Brass, tin/zinc-plated and or stainless steel.

## ADDITIONAL CHARACTERISTICS

### Standard Style and Military Qualified

**Contacts:** Shorting or Non-shorting contacts available in 30°, 36° and 45° angle of throw rotary switches. Non-shorting contacts available in 60° and 90° angle of throw switches. All are wiping contacts with over 100 grams of contact force.

**Stop Strength:** 12 lb-inches minimum

**Rotational Torque:** 8-64 oz-in depending upon the number of poles per deck and the number of decks

**Extended Studs:** Switches of six decks or more have longer studs with extra stud nuts for recommended double end mounting.

**CHOICES AND LIMITATIONS**

Series	Style and Designation	Angle of Throw	Stops	Terminals	Number of Decks		Poles Per Deck	Number of Positions/Pole	
					Shorting	Non-Shorting			
08	A = Standard S = Standard, Shaft/Panel Seal M = Military Style MS = Style M, Shaft/Panel Seal	36°	Fixed	Solder	01 thru 12 01 thru 09	01 thru 12 01 thru 09	1 2	02 thru 10 02 thru 05	
	Printed Circuit			01 thru 12 01 thru 09	01 thru 12 01 thru 09	1 2	02 thru 10 02 thru 05		
09	A = Standard S = Standard, Shaft/Panel Seal M = Military Style MS = Style M, Shaft/Panel Seal	30°	Fixed	Solder	01 thru 12 01 thru 09 01 thru 06 01 thru 04 01 thru 03 01 thru 03	01 thru 12 01 thru 09 01 thru 06 01 thru 04 01 thru 03 01 thru 03	1 2 3 4 5 6	02 thru 12 02 thru 06 02 thru 04 02 or 03 02 02	
	P = Standard, PC Mount SP = Style P, Shaft/Panel Seal MP = Military Style, PC Mount MSP = Style MP, Shaft/Panel Seal				45°	Printed Circuit	01 thru 12 01 thru 09	01 thru 12 01 thru 09	1 2
	A = Standard, S = Standard, Shaft/Panel Seal M = Military Style MS = Style M, Shaft/Panel Seal	60°					Solder	01 thru 12 01 thru 06 01 thru 04 01 thru 03	01 thru 12 01 thru 06 01 thru 04 01 thru 03
	A = Standard, S = Standard, Shaft/Panel Seal M = Military Style MS = Style M, Shaft/Panel Seal				90°	Not Available		01 thru 06 01 thru 03 01 or 02	01 thru 06 01 thru 03 01 or 02
	P = Standard, PC Mount SP = Style P, Shaft/Panel Seal MP = Military Style, PC Mount MSP = Style MP, Shaft/Panel Seal	Printed Circuit					Not Available	01 thru 06 01 thru 03	1 2
	A = Standard S = Standard, Shaft/Panel Seal				Solder	Not Available	01 thru 06 01 thru 03	1 2	02 thru 04 02
	P = Standard, PC Mount SP = Style, Shaft/Panel Seal	Printed Circuit		Not Available		01 thru 06 01 thru 03	1 2	02 thru 04 02	

Rotary Switches

**ORDERING INFORMATION**

**09A30-03-1-12N-F**

**Series:** determined by the angle of throw

**Style\*:** Letter(s) from the Choices and Limitations chart

**Angle of Throw:** Must agree with Series Number

**Stop Arrangement:** Add letter C or F to a one pole per deck switch with the maximum number of positions for a stop between position 1 and the last position.

**Type of Contacts:** N = Non-shorting; S = Shorting

**Positions Per Pole:** Requires 02 positions as a minimum to the maximum allowable dependent on the angle of throw and poles per deck

**Poles Per Deck:** As limited by angle of throw and switch style

**Number of Decks:** As limited by the angle of throw, the poles per deck, switch style and types of contacts

*\* All rotary switches that are required to have military designated markings and testing adhering to MIL-3786 are to be ordered by specifying the military part number identified on the appropriate slash sheet.*

Компания «Океан Электроники» предлагает заключение долгосрочных отношений при поставках импортных электронных компонентов на взаимовыгодных условиях!

Наши преимущества:

- Поставка оригинальных импортных электронных компонентов напрямую с производств Америки, Европы и Азии, а так же с крупнейших складов мира;
- Широкая линейка поставок активных и пассивных импортных электронных компонентов (более 30 млн. наименований);
- Поставка сложных, дефицитных, либо снятых с производства позиций;
- Оперативные сроки поставки под заказ (от 5 рабочих дней);
- Экспресс доставка в любую точку России;
- Помощь Конструкторского Отдела и консультации квалифицированных инженеров;
- Техническая поддержка проекта, помощь в подборе аналогов, поставка прототипов;
- Поставка электронных компонентов под контролем ВП;
- Система менеджмента качества сертифицирована по Международному стандарту ISO 9001;
- При необходимости вся продукция военного и аэрокосмического назначения проходит испытания и сертификацию в лаборатории (по согласованию с заказчиком);
- Поставка специализированных компонентов военного и аэрокосмического уровня качества (Xilinx, Altera, Analog Devices, Intersil, Interpoint, Microsemi, Actel, Aeroflex, Peregrine, VPT, Syfer, Eurofarad, Texas Instruments, MS Kennedy, Miteq, Cobham, E2V, MA-COM, Hittite, Mini-Circuits, General Dynamics и др.);

Компания «Океан Электроники» является официальным дистрибьютором и эксклюзивным представителем в России одного из крупнейших производителей разъемов военного и аэрокосмического назначения «JONHON», а так же официальным дистрибьютором и эксклюзивным представителем в России производителя высокотехнологичных и надежных решений для передачи СВЧ сигналов «FORSTAR».



## JONHON

«JONHON» (основан в 1970 г.)

Разъемы специального, военного и аэрокосмического назначения:

(Применяются в военной, авиационной, аэрокосмической, морской, железнодорожной, горно- и нефтедобывающей отраслях промышленности)

«FORSTAR» (основан в 1998 г.)

ВЧ соединители, коаксиальные кабели,  
кабельные сборки и микроволновые компоненты:

(Применяются в телекоммуникациях гражданского и специального назначения, в средствах связи, РЛС, а так же военной, авиационной и аэрокосмической отраслях промышленности).



Телефон: 8 (812) 309-75-97 (многоканальный)

Факс: 8 (812) 320-03-32

Электронная почта: [ocean@oceanchips.ru](mailto:ocean@oceanchips.ru)

Web: <http://oceanchips.ru/>

Адрес: 198099, г. Санкт-Петербург, ул. Калинина, д. 2, корп. 4, лит. А