

QME48T35120

Quarter-Brick DC-DC Converter

The new high performance 35A **QME48T35120** DC-DC converter provides a high efficiency single output, in a 1/4 brick package. Specifically designed for operation in systems that have limited airflow and increased ambient temperatures, the QME48T35120 converter utilizes the same pin-out and Input/Output functionality of the industry-standard quarter-bricks. In addition, a baseplate feature is available (-xxxBx suffix) that provides an effective thermal interface for coldplate and heat sinking options.

The QME48T35120 converter thermal performance is accomplished through the use of patent-pending circuits, packaging, and processing techniques to achieve ultra-high efficiency, excellent thermal management, and a low-body profile.

Low-body profile and the preclusion of heat sinks minimize impedance to system airflow, thus enhancing cooling for both upstream and downstream devices. The use of 100% automation for assembly, coupled with advanced electronic circuits and thermal design, results in a product with extremely high reliability.

Operating from a wide-range 36-75V input, the QME48T35120 converter provides a fully regulated 12.0V output voltage. Employing a standard power pin-out, the QME48T35120 converter is an ideal drop-in replacement for existing high current quarter-brick designs. Inclusion of this converter in a new design can result in significant board space and cost savings. The designer can expect reliability improvement over other available converters because of the QME48T35120 optimized thermal efficiency.



Key Features & Benefits

- RoHS lead-free solder and lead-solder-exempted products are available
- Delivers up to 35 A (420 Watts)
- Industry-standard quarter-brick pinout
- On-board input differential LC-filter
- Startup into pre-biased load
- No minimum load required
- Meets Basic Insulation requirements of EN60950-1
- Withstands 100 V input transient for 100 ms
- Fixed frequency operation
- Fully protected (OTP, OCP, OVP, UVLO) with automatic recovery
- Positive or negative logic ON/OFF option
- Low height of 0.430" (10.4mm)
- Weight: 1.75 oz (49.6g), 2.15 oz (61.0g) w/baseplate
- High reliability: MTBF approx. 18.8 million hours, calculated per Telcordia TR-332, Method I Case 1
- Approved to the latest edition and amendment of ITE Safety standards, UL/CSA 60950-1 and IEC60950-1
- Designed to meet Class B conducted emissions per FCC and EN55022 when used with external filter
- All materials meet UL94, V-0 flammability rating



bel POWER
SOLUTIONS &
PROTECTION

a bel group

belfuse.com/power-solutions

1. ELECTRICAL SPECIFICATIONS

Conditions: $T_A = 25^\circ\text{C}$, Airflow = 300 LFM (1.5 m/s), $V_{in} = 48\text{ VDC}$, unless otherwise specified.

PARAMETER	CONDITIONS / DESCRIPTION	MIN	TYP	MAX	UNITS
Absolute Maximum Ratings					
Input Voltage	Continuous	0		80	VDC
Input Transient Voltage	100 ms			100	VDC
Operating Ambient Temperature (T_A)		-40		85	$^\circ\text{C}$
Operating Component Temperature (T_C)		-40		125	$^\circ\text{C}$
Operating Baseplate Temperature (T_B)		-40		105	$^\circ\text{C}$
Storage Temperature		-55		125	$^\circ\text{C}$
Input Characteristics					
Operating Input Voltage Range		36	48	75	VDC
Input Under Voltage Lockout (Non-latching)	Turn-on Threshold	31.5	34	35.5	VDC
	Turn-off Threshold	30	33	34.5	VDC
Lockout Hysteresis Voltage		0.5		2	VDC
Input Voltage Transient Rate				7	V/ms
Maximum Input Current	35 ADC, 12 VDC Out @ 36 VDC In			12.3	ADC
Input Stand-by Current	Converter disabled		10		mADC
Input Current @ No Load	Converter enabled		95		mADC
Minimum Input Capacitance (external)	ESR < 0.7 Ω	150			μF
Inrush Transient				0.1	A^2S
Input Reflected-Ripple Current, i_c	25 MHz bandwidth, $I_o = 35\text{ Amperes}$ (Figure 39)		1250		$\text{mA}_{\text{PK-PK}}$
Input Reflected-Ripple Current, i_s			100		$\text{mA}_{\text{PK-PK}}$
Input Voltage Ripple Rejection	120 Hz		45		dB
Output Characteristics					
Output Voltage Set Point (no load) ¹		11.76	12.00	12.24	VDC
Output Regulation ¹					
Over Line	$V_{in} = 39\text{ to }75\text{VDC}$ [$I_{OUT} = 35\text{Amps}$]		± 60	± 120	mV
Over Load			± 60	± 120	mV
Output Voltage Range ¹	Over line (39 to 75VDC), load and temp. ²	11.64		12.36	VDC
	Over line (36 to 75VDC), load and temp. ²	11.00		12.36	VDC
Output Ripple and Noise – 20 MHz bandwidth	$I_{OUT} = 35\text{Amps}$		100	150	$\text{mV}_{\text{PK-PK}}$
	$C_{EXT} = 10\ \mu\text{F}$ tantalum + 1 μF ceramic			60	mV_{RMS}
External Load Capacitance (Resistive load)	suffix ‘-xxxBx’	C_{EXT}	0	20,000	μF
	suffix ‘-xxxBx’	ESR	1.000		$\text{m}\Omega$
	suffix ‘-xxxBxS377’	C_{EXT}	270	7000	μF
	suffix ‘-xxxBxS377’	ESR	1.7		$\text{m}\Omega$
Output Current Range				35	ADC
Current Limit Inception	Non-latching	110		143	% I_{omax}
Peak Short-Circuit Current ³	Non-latching, Short = 10 m Ω		55	70	A
RMS Short-Circuit Current	Non-latching		5		Arms

Isolation Characteristics					
I/O Isolation (suffix ' -xxx0x')		1.500			VDC
Isolation Capacitance	Input-to-Output		1300		ρF
Isolation Resistance		10			MΩ
I/O Isolation (suffix ' -xxxBx')	Input-to-Output & Baseplate-to-Input/Output	1.500			VDC
Isolation Capacitance	Input-to-Output		1300		ρF
Isolation Resistance	Input-to-Output & Baseplate-to-Input/Output	10			MΩ
Feature Characteristics					
Switching Frequency			250		kHz
Output Voltage Trim Range ⁴			n/a		%
Remote Sense Compensation ⁴			n/a		%
Output Overvoltage Protection	Non-latching	117	122	127	%
Over-Temperature Shutdown (PCB)	Non-latching		130		°C
Auto-Restart Period	Applies to all protection features		200		ms
Turn-On Time including Rise Time	20,000μF plus Full Load (resistive)		15	30	ms
Rise Time	From 10% to 90%		13	25	ms
Turn-On Time from Vin	Time from UVLO to Vo=90%V _{OUT} (NOM) Resistive load	3	5	10	ms
Turn-On Time from ON/OFF Control	Time from UVLO to Vo=90%V _{OUT} (NOM) Resistive load		12		ms
Turn-On Time from Vin (w/Cext max.)	Time from UVLO to Vo=90%V _{OUT} (NOM) Resistive load, CEXT=10,000μF load	5	10	25	ms
Turn-On Time from ON/OFF Control (w/Cext max.)	Time from ON to Vo=90%V _{OUT} (NOM) Resistive load, CEXT=10,000μF load		14		ms
ON/OFF Control (Positive Logic)					
Converter Off (logic low)		-20		0.8	VDC
Converter On (logic high)		2.4		20	VDC
ON/OFF Control (Negative Logic)					
Converter Off (logic low)		2.4		20	VDC
Converter On (logic high)		-20		0.8	VDC
Dynamic Response					
Load Change 50%-75%-50%, di/dt = 0.1A/μs	Co = 1 μF ceramic + 10μF tantalum		200	360	mV
	di/dt = 1.0 A/μs Co = 1 μF ceramic + 10μF tantalum		350	540	mV
Settling Time to 1% of V _{OUT}			200		μs
Efficiency					
100% Load	Vin = 39VDC		95		%
50% Load	Vin = 39VDC		96		%
Environmental					
Operating Humidity	Non-condensing		95		%
Storage Humidity	Non-condensing		95		%



Asia-Pacific
+86 755 298 85888

Europe, Middle East
+353 61 225 977

North America
+1 408 785 5200

Mechanical			
Weight	No baseplate	1.75 [49.6]	oz [g]
	With baseplate	2.15 [61.0]	
Vibration	GR-63-CORE, Sect. 5.4.2	1	g
Shocks	Half Sinewave, 3-axis	50	g
Reliability			
MTBF	Telcordia SR-332, Method I Case 1 50% electrical stress, 40°C components	18.8	MHrs
EMI and Regulatory Compliance			
Conducted Emissions	CISPR 22 B with external EMI filter network (See Fig. 41)		

- 1) Measured at the output pins of the converter.
- 2) Operating ambient temperature range of -40 °C to 85 °C for converter.
- 3) Peak currents exist for approximately 500uSec per 200msec period.
- 4) This functionality not provided, however the unit is fully regulated.

2. OPERATIONS

2.1 INPUT AND OUTPUT IMPEDANCE

These power converters have been designed to be stable with no external capacitors when used in low inductance input and output circuits.

In many applications, the inductance associated with the distribution from the power source to the input of the converter can affect the stability of the converter. The addition of a 150 μF electrolytic capacitor with an ESR $< 0.7 \Omega$ across the input helps to ensure stability of the converter. In many applications, the user has to use decoupling capacitance at the load. The power converter will exhibit stable operation with external load capacitance up to 20,000 μF .

Additionally, see the EMC section of this data sheet for discussion of other external components which may be required for control of conducted emissions.

2.2 ON/OFF (Pin 2)

The ON/OFF pin is used to turn the power converter on or off remotely via a system signal. There are two remote control options available, positive and negative logic, with both referenced to $V_{in(-)}$. A typical connection is shown in Fig. 1.

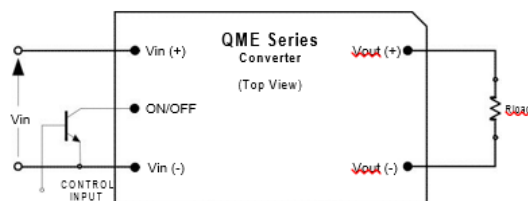

Figure 1. Circuit configuration for ON/OFF function.

The positive logic version turns on when the ON/OFF pin is at logic high and turns off when at logic low. The converter is on when the ON/OFF pin is left open. See the Electrical Specifications for logic high/low definitions.

The negative logic version turns on when the ON/OFF pin is at logic low and turns off when the ON/OFF pin is at logic high. The ON/OFF pin can be hardwired directly to $V_{in(-)}$ to enable automatic power up of the converter without the need of an external control signal.

The ON/OFF pin is internally pulled up to 5 V through a resistor. A properly debounced mechanical switch, open-collector transistor, or FET can be used to drive the input of the ON/OFF pin. The device must be capable of sinking up to 0.2mA at a low level voltage of 0.8 V. An external voltage source (± 20 V maximum) may be connected directly to the ON/OFF input, in which case it must be capable of sourcing or sinking up to 1mA depending on the signal polarity. See the Startup Information section for system timing waveforms associated with use of the ON/OFF pin.

The converter's output overvoltage protection (OVP) senses the voltage across $V_{out(+)}$ and $V_{out(-)}$, so the resistance (and resulting voltage drop) between the output pins of the converter and the load should be minimized to prevent unwanted triggering of the OVP function.

3. PROTECTION FEATURES

3.1 INPUT UNDERVOLTAGE LOCKOUT

Input under-voltage lockout is standard with this converter. The converter will shut down when the input voltage drops below a pre-determined voltage.

The input voltage must be typically 34 V for the converter to turn on. Once the converter has been turned on, it will shut off when the input voltage drops typically below 33 V. This feature is beneficial in preventing deep discharging of batteries used in telecom applications.

3.2 OUTPUT OVERCURRENT PROTECTION (OCP)

The converter is protected against overcurrent or short circuit conditions. Upon sensing an overcurrent condition, the converter will switch to constant current operation and thereby begin to reduce output voltage. When the output voltage drops below approx. 60% of the nominal value of output voltage, the converter will shut down.

Once the converter has shut down, it will attempt to restart nominally every 200 ms with a typical 3% duty cycle. The attempted restart will continue indefinitely until the overload or short circuit conditions are removed or the output voltage rises above 60% of its nominal value.

Once the output current is brought back into its specified range, the converter automatically exits the hiccup mode and continues normal operation.

3.3 OUTPUT OVERVOLTAGE PROTECTION (OVP)

The converter will shut down if the output voltage across Vout(+) (Pin 5) and Vout(-) (Pin 4) exceeds the threshold of the OVP circuitry. The OVP circuitry contains its own reference, independent of the output voltage regulation loop. Once the converter has shut down, it will attempt to restart every 200 ms until the OVP condition is removed.

3.4 OVERTEMPERATURE PROTECTION (OTP)

The converter will shut down under an over temperature condition to protect itself from overheating caused by operation outside the thermal derating curves, or operation in abnormal conditions such as system fan failure. After the converter has cooled to a safe operating temperature, it will automatically restart.

3.5 SAFETY REQUIREMENTS

The converters are safety approved to UL/CSA60950-1, EN60950-1, and IEC60950-1. Basic Insulation is provided between input and output.

The converters have no internal fuse. To comply with safety agencies requirements, an input line fuse must be used external to the converter. A 20-A fuse is recommended for use with this product.

The QME48T35120 converter is CSA approved for a maximum fuse rating of 20A.

3.6 ELECTROMAGNETIC COMPATIBILITY (EMC)

EMC requirements must be met at the end-product system level, as no specific standards dedicated to EMC characteristics of board mounted component dc-dc converters exist. However, Power Bel Solutions tests its converters to several system level standards, primary of which is the more stringent EN55022,

Information technology equipment - Radio disturbance characteristics-Limits and methods of measurement.

An effective internal LC differential filter significantly reduces input reflected ripple current, and improves EMC.

With the addition of a simple external filter, the QME48T35120 converter will pass the requirements of Class B conducted emissions per EN55022 and FCC requirements. Refer to Figures 41 and 42 for typical performance with external filter.

3.7 ABSENCE OF THE REMOTE SENSE PINS

Users should note that this converter does not have a Remote Sense feature. Care should be taken to minimize voltage drop on the user's motherboard.



Asia-Pacific
+86 755 298 85888

Europe, Middle East
+353 61 225 977

North America
+1 408 785 5200

3.8 STARTUP INFORMATION (USING NEGATIVE ON/OFF)

Scenario #1: Initial Startup From Bulk Supply

ON/OFF function enabled, converter started via application of V_{IN} . See Figure 2.

Time	Comments
t_0	ON/OFF pin is ON; system front-end power is toggled on, V_{IN} to converter begins to rise.
t_1	V_{IN} crosses Under-Voltage Lockout protection circuit threshold; converter enabled.
t_2	Converter begins to respond to turn-on command (converter turn-on delay).
t_3	Converter V_{OUT} reaches 100% of nominal value

For this example, the total converter startup time ($t_3 - t_1$) is typically 8 ms.

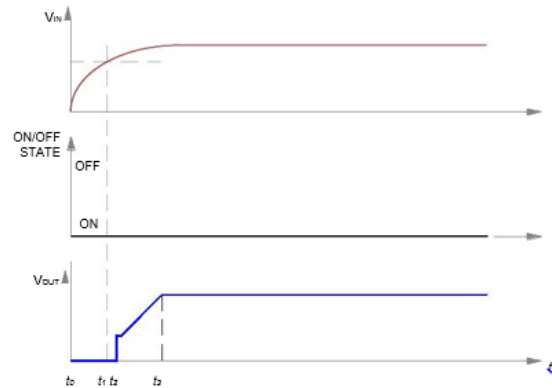

Figure 2. Start-up scenario #1.

Scenario #2: Initial Startup Using ON/OFF Pin

With V_{IN} previously powered, converter started via ON/OFF pin. See Figure 3.

Time	Comments
t_0	V_{INPUT} at nominal value.
t_1	Arbitrary time when ON/OFF pin is enabled (converter enabled).
t_2	End of converter turn-on delay.
t_3	Converter V_{OUT} reaches 100% of nominal value.

For this example, the total converter startup time ($t_3 - t_1$) is typically 8 ms.

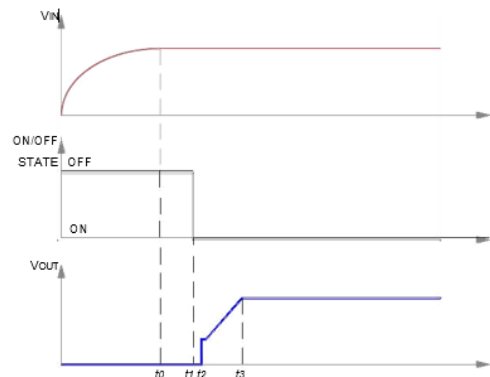

Figure 3. Startup scenario #2.

Scenario #3: Turn-off and Restart Using ON/OFF Pin

With V_{IN} previously powered, converter is disabled and then enabled via ON/OFF pin. See Figure 4.

Time	Comments
t_0	V_{IN} and V_{OUT} are at nominal values; ON/OFF pin ON.
t_1	ON/OFF pin arbitrarily disabled; converter output falls to zero; turn-on inhibit delay period (200 ms typical) is initiated, and ON/OFF pin action is internally inhibited.
t_2	ON/OFF pin is externally re-enabled. If $(t_2 - t_1) \leq 200$ ms, external action of ON/OFF pin is locked out by startup inhibit timer. If $(t_2 - t_1) > 200$ ms, ON/OFF pin action is internally enabled.
t_3	Turn-on inhibit delay period ends. If ON/OFF pin is ON, converter begins turn-on; if off, converter awaits ON/OFF pin ON signal; see Figure 4.
t_4	End of converter turn-on delay.
t_5	Converter V_{OUT} reaches 100% of nominal value.

For the condition, $(t_2 - t_1) \leq 200$ ms, the total converter startup time ($t_5 - t_2$) is typically 208 ms. For $(t_2 - t_1) > 200$ ms, startup will be typically 8 ms after release of ON/OFF pin.

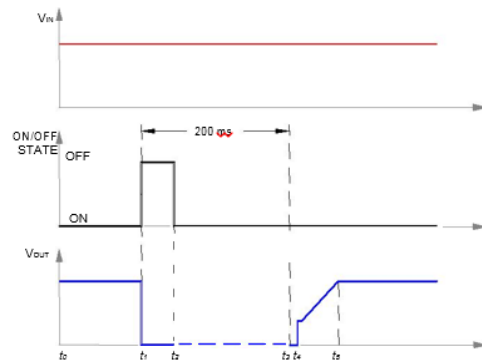

Figure 4. Startup scenario #3.

4. CHARACTERIZATION

4.1 GENERAL INFORMATION

The converter has been characterized for many operational aspects, to include thermal derating (maximum load current as a function of ambient temperature and airflow) for vertical and horizontal mountings, efficiency, startup and shutdown parameters, output ripple and noise, transient response to load step-change, overload, and short circuit.

4.2 TEST CONDITIONS

All data presented were taken with the converter soldered to a test board, specifically a 0.060" thick printed wiring board (PWB) with four layers. The top and bottom layers were not metalized. The two inner layers, comprised of two-ounce copper, were used to provide traces for connectivity to the converter.

The lack of metallization on the outer layers as well as the limited thermal connection ensured that heat transfer from the converter to the PWB was minimized. This provides a worst-case but consistent scenario for thermal derating purposes.

All measurements requiring airflow were made in the vertical and horizontal wind tunnel using Infrared (IR) thermography and thermocouples for thermometry.

Ensuring components on the converter do not exceed their ratings is important to maintaining high reliability. If one anticipates operating the converter at or close to the maximum loads specified in the derating curves, it is prudent to check actual operating temperatures in the application. Thermographic imaging is preferable; if this capability is not available, then thermocouples may be used. The use of AWG #36 gauge thermocouples is recommended to ensure measurement accuracy. Careful routing of the thermocouple leads will further minimize measurement error. Refer to Fig. 5 for the optimum measuring thermocouple location.

4.3 THERMAL DERATING

Thermal characterization is provided for the hotspot temperatures of both 120°C and 125°C.

Load current vs. ambient temperature and airflow rates are shown in Fig. 6, Fig. 8, Fig. 10 and Fig. 12. Ambient temperature was varied between 25°C and 85°C, with airflow rates from 30 to 500 LFM (0.15 to 2.5 m/s).

For each set of conditions, the maximum load current was defined as the lowest of:

Case I : T_c (Hotspot) \leq 120°C

- (i) The output current at which any FET junction (T_J) temperature does not exceed a maximum temperature of 120°C as indicated by the thermal measurement, or
- (ii) The output current at which the temperature at the thermocouple locations TC do not exceed 120°C. (Fig. 5)
- (iii) The nominal rating of the converter (35 A).

Case II : T_c (Hotspot) \leq 125°C

- (i) The output current at which any FET junction (T_J) temperature does not exceed a maximum temperature of 125°C as indicated by the thermal measurement, or
- (ii) The output current at which the temperature at the thermocouple locations TC do not exceed 125°C. (Fig. 5)
- (iii) The nominal rating of the converter (35 A).

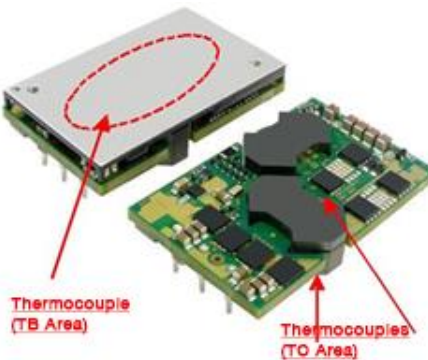

Figure 5. Location of the thermocouples for thermal testing

4.4 OUTPUT POWER

The output power vs. ambient temperature and airflow rates are given in Fig. 7 and Fig. 9 w/o baseplate. The output power vs. ambient temperature and airflow rates are given in Fig. 11 and Fig. 13 with baseplate. The ambient temperature varies between 25°C and 85°C with airflow rates from 30 to 500 LFM (0.15 to 2.5 m/s).

4.5 THERMAL DERATING – BASEPLATE COOLED

The maximum load current rating vs. baseplate temperature is provided for Baseplate Models with commercially available heatsinks attached. The various configurations, T_{C-MAX} (Hotspot) and Figure references, are listed below.

Note: T_C Hotspot $\approx T_J$ MOSFET

For a ¼" heatsink, AAvid Thermalloy PNU 241402B92200G, $T_C \leq 120^\circ\text{C}$, current derating is provided in Figure 14. Power Derating is provided in Figure 15.

For a ¼" heatsink, AAvid Thermalloy PNU 241402B92200G, $T_C \leq 125^\circ\text{C}$, current derating is provided in Figure 16. Power Derating is provided in Figure 17.

For a ½" heatsink, AAvid Thermalloy PNU 241404B92200G, $T_C \leq 120^\circ\text{C}$, current derating is provided in Figure 18. Power Derating is provided in Figure 19.

For a ½" heatsink, AAvid Thermalloy PNU 241404B92200G, $T_C \leq 125^\circ\text{C}$, current derating is provided in Figure 20. Power Derating is provided in Figure 21.

For a 1" heatsink, AAvid Thermalloy PNU 241409B92200G, $T_C \leq 120^\circ\text{C}$, current derating is provided in Figure 22. Power Derating is provided in Figure 23.

For a 1" heatsink, AAvid Thermalloy PNU 241409B92200G, $T_C \leq 125^\circ\text{C}$, current derating is provided in Figure 24. Power Derating is provided in Figure 25.

4.6 THERMAL DERATING – COLDPLATE COOLED

The converter was shielded from air flow. The baseplate temperature was maintained $\leq 85^\circ\text{C}$, with an airflow rate of $\geq 30\text{LFM}$ ($\geq 0.15\text{m/s}$). Thermocouple measurements (in Fig. 5) were recorded as $T_C \leq 120^\circ\text{C}$ and $T_B \leq 85^\circ\text{C}$. Refer to Figure 26 and Figure 27.

4.7 EFFICIENCY

Efficiency vs. load current is showing in Fig. 28 for ambient temperature (T_A) of 25°C, airflow rate of 300LFM (1.5m/s) with vertical mounting and input voltages of 36V, 48V, and 75V. Also, a plot of efficiency vs. load current, as a function of ambient temperature with $V_{in} = 48\text{V}$, airflow rate of 200 LFM (1 m/s) with vertical mounting is shown in Fig. 29.

4.8 POWER DISSIPATION

Power dissipation vs. load current is showing in Fig. 30 for $T_A = 25^\circ\text{C}$, airflow rate of 300LFM (1.5m/s) with vertical mounting and input voltages of 36V, 48V, and 75V. Also, a plot of power dissipation vs. load current, as a function of ambient temperature with $V_{in} = 48\text{V}$, airflow rate of 200 LFM (1m/s) with vertical mounting is shown in Fig. 31.

4.9 START UP

Output voltage waveforms, during the turn-on transient using the ON/OFF pin for full rated load currents (resistive load) are shown without and with external load capacitance in Fig. 30 and Fig. 33, respectively.

4.10 RIPPLE AND NOISE

Fig. 36 show the output voltage ripple waveform, measured at full rated load current with a 10 μF tantalum and 1 μF ceramic capacitor across the output. Note that all output voltage waveforms are measured across a 1 μF ceramic capacitor. The input reflected ripple current waveforms are obtained using the test setup shown in Fig. 37. The corresponding waveforms are shown in Fig. 38 and Fig. 39.

Figures 6 & 7 without Baseplate, $T_C \leq 120\text{ }^\circ\text{C}$.

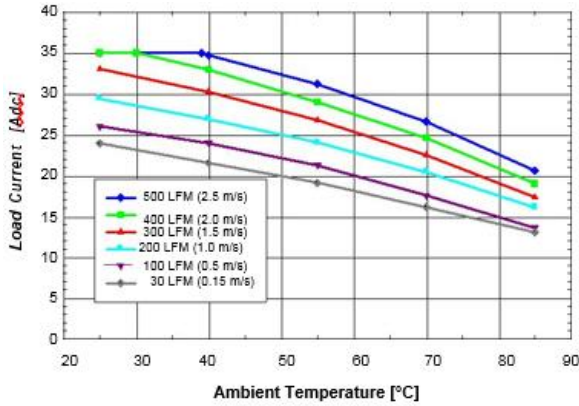

Figure 6. Available output current vs. ambient air temperature and airflow rates for converter w/o baseplate mounted vertically with air flowing from pin 1 to pin 3, MOSFET temperature $\leq 120\text{ }^\circ\text{C}$, $V_{in} = 48\text{ V}$.

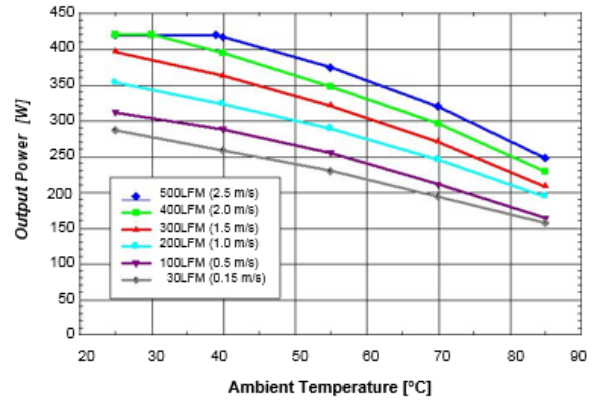

Figure 7. Available output power vs. ambient air temperature and airflow rates for converter w/o baseplate mounted vertically with air flowing from pin 1 to pin 3, MOSFET temperature $\leq 120\text{ }^\circ\text{C}$, $V_{in} = 48\text{ V}$.

Figures 8 & 9 with Baseplate, $T_C \leq 120\text{ }^\circ\text{C}$.

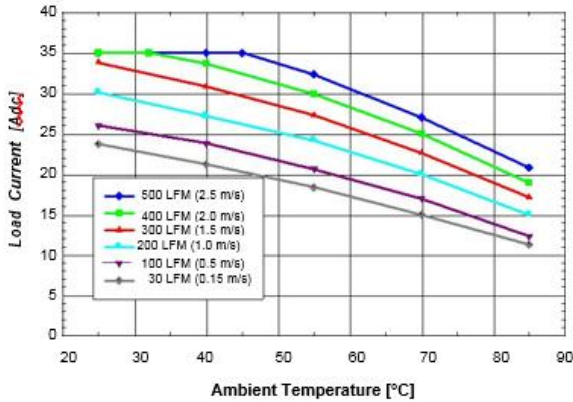

Figure 8. Available output current vs. ambient air temperature and airflow rates for converter with baseplate mounted vertically with air flowing from pin 1 to pin 3, MOSFET temperature $\leq 120\text{ }^\circ\text{C}$, $V_{in} = 48\text{ V}$.

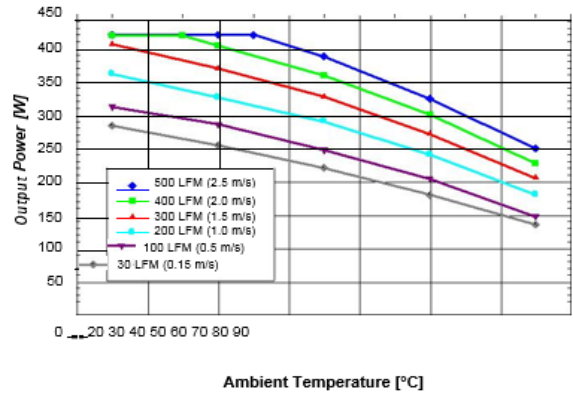

Figure 9. Available output power vs. ambient air temperature and airflow rates for converter with baseplate mounted vertically with air flowing from pin 1 to pin 3, MOSFET temperature $\leq 120\text{ }^\circ\text{C}$, $V_{in} = 48\text{ V}$.

Figures 10 & 11 without Baseplate, $T_C \leq 125^\circ\text{C}$.

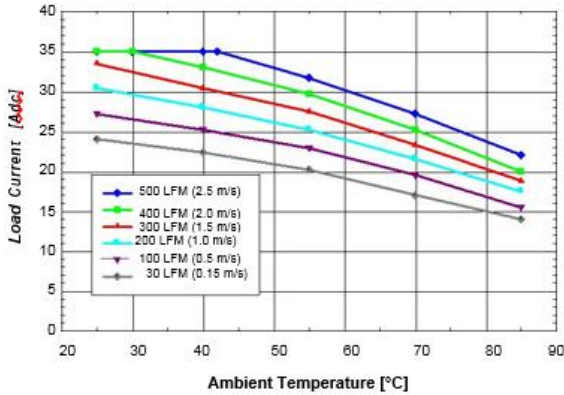

Figure 10. Available output current vs. ambient air temperature and airflow rates for converter w/o baseplate mounted vertically with air flowing from pin 1 to pin 3, MOSFET temperature $\leq 125^\circ\text{C}$, $V_{in} = 48\text{ V}$.

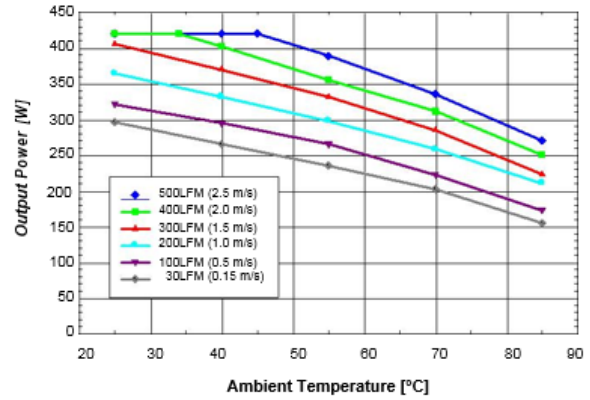

Figure 11. Available output power vs. ambient air temperature and airflow rates for converter w/o baseplate mounted vertically with air flowing from pin 1 to pin 3, MOSFET temperature $\leq 125^\circ\text{C}$, $V_{in} = 48\text{ V}$.

Figures 12 & 13 with Baseplate, $T_C \leq 125^\circ\text{C}$.

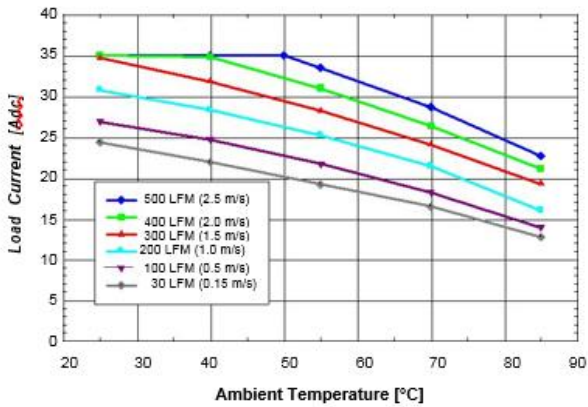

Figure 12. Available output current vs. ambient air temperature and airflow rates for converter with baseplate mounted vertically with air flowing from pin 1 to pin 3, MOSFET temperature $\leq 125^\circ\text{C}$, $V_{in} = 48\text{ V}$.

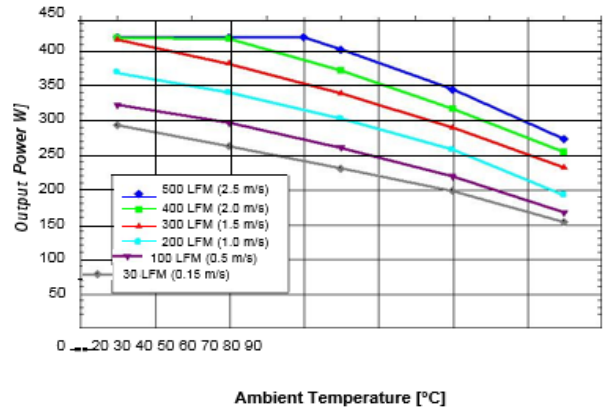

Figure 13. Available output power vs. ambient air temperature and airflow rates for converter with baseplate mounted vertically with air flowing from pin 1 to pin 3, MOSFET temperature $\leq 125^\circ\text{C}$, $V_{in} = 48\text{ V}$.

Figures 14 & 15 with 1/4" Finned Heatsink, $T_C \leq 120^\circ\text{C}$.

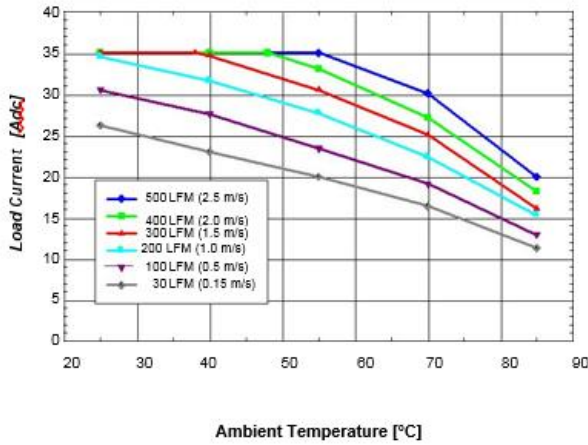

Figure 14. Available output current vs. ambient air temperature and airflow rates for converter mounted vertically with air flowing from pin 1 to pin 3, MOSFET temperature $\leq 120^\circ\text{C}$, $V_{in} = 48\text{ V}$, $1/4''$ Heatsink.

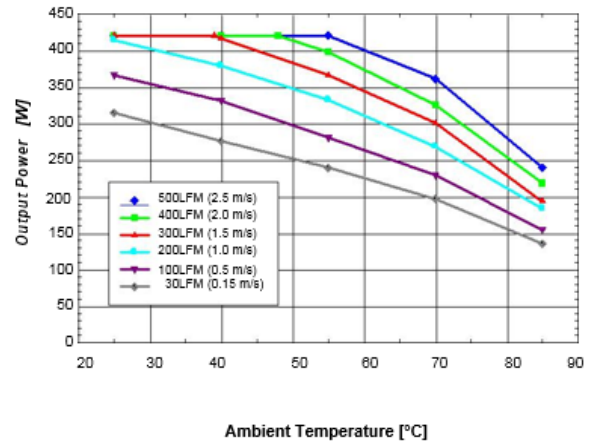

Figure 15. Available output power vs. ambient air temperature and airflow rates for converter mounted vertically with air flowing from pin 1 to pin 3, MOSFET temperature $\leq 120^\circ\text{C}$, $V_{in} = 48\text{ V}$, $1/4''$ Heatsink.

Figures 16 & 17 with 1/4" Finned Heatsink, $T_C \leq 125^\circ\text{C}$.

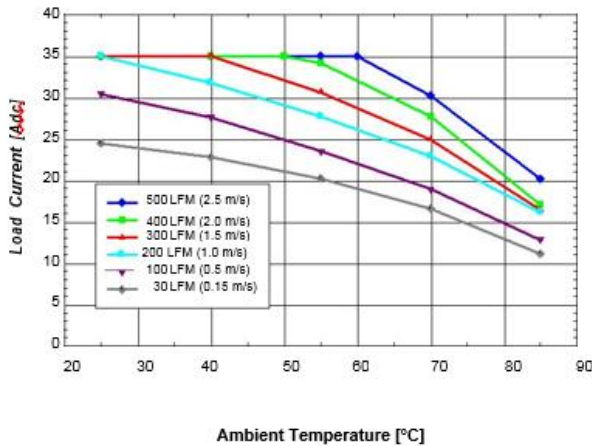

Figure 16. Available output current vs. ambient air temperature and airflow rates for converter mounted vertically with air flowing from pin 1 to pin 3, MOSFET temperature $\leq 125^\circ\text{C}$, $V_{in} = 48\text{ V}$, $1/4''$ Heatsink.

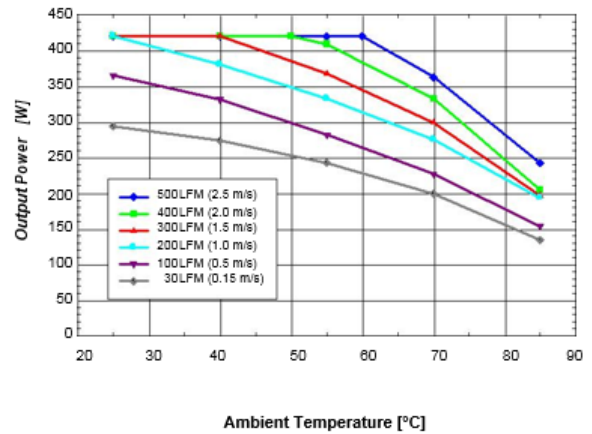

Figure 17. Available output power vs. ambient air temperature and airflow rates for converter mounted vertically with air flowing from pin 1 to pin 3, MOSFET temperature $\leq 125^\circ\text{C}$, $V_{in} = 48\text{ V}$, $1/4''$ Heatsink.

Figures 18 & 19 with 1/2" Finned Heatsink, $T_C \leq 120^\circ\text{C}$.

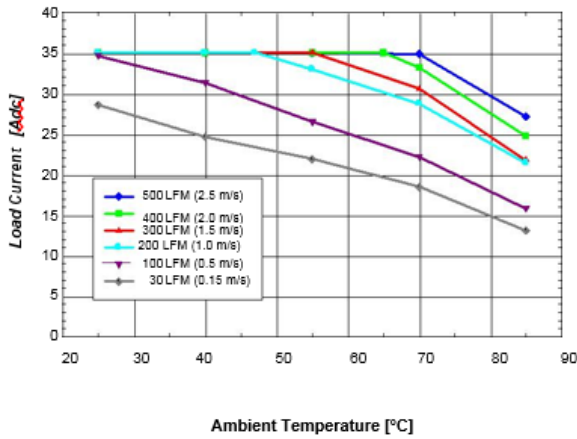

Figure 18. Available output current vs. ambient air temperature and airflow rates for converter mounted vertically with air flowing from pin 1 to pin 3, MOSFET temperature $\leq 120^\circ\text{C}$, $V_{in} = 48\text{ V}$, 1/2" Heatsink.

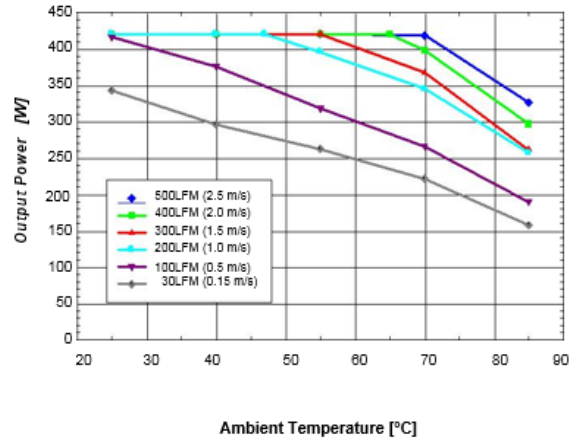

Figure 19. Available output power vs. ambient air temperature and airflow rates for converter mounted vertically with air flowing from pin 1 to pin 3, MOSFET temperature $\leq 120^\circ\text{C}$, $V_{in} = 48\text{ V}$, 1/2" Heatsink.

Figures 20 & 21 with 1/2" Finned Heatsink, $T_C \leq 125^\circ\text{C}$.

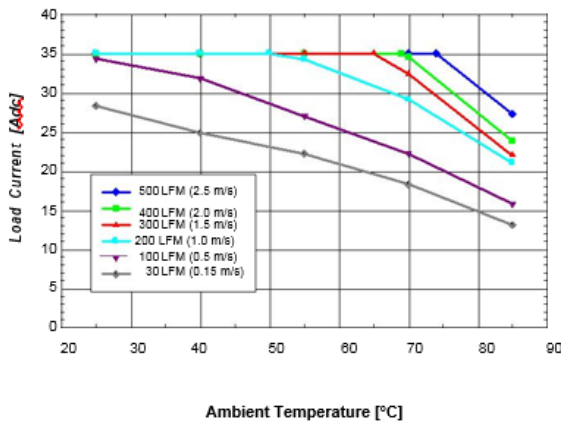

Figure 20. Available output current vs. ambient air temperature and airflow rates for converter mounted vertically with air flowing from pin 1 to pin 3, MOSFET temperature $\leq 125^\circ\text{C}$, $V_{in} = 48\text{ V}$, 1/2" Heatsink.

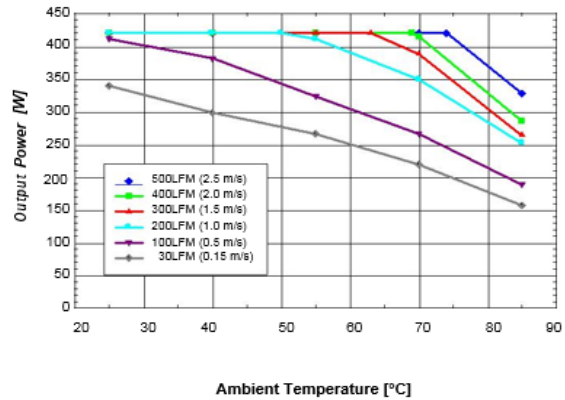

Figure 21. Available output power vs. ambient air temperature and airflow rates for converter mounted vertically with air flowing from pin 1 to pin 3, MOSFET temperature $\leq 125^\circ\text{C}$, $V_{in} = 48\text{ V}$, 1/2" Heatsink.

Figures 22 & 23 with 1" Finned Heatsink, $T_c \leq 120^\circ\text{C}$.

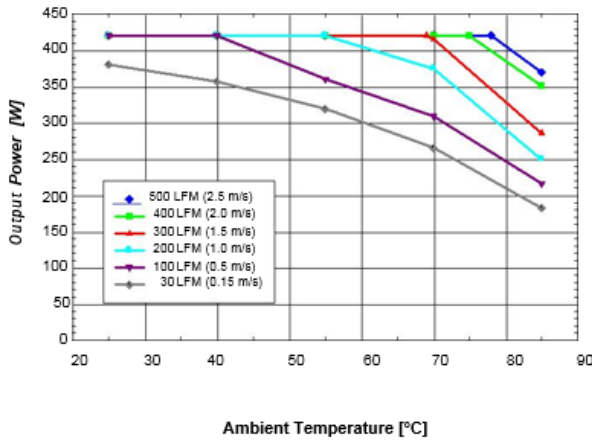

Figure 22. Available output current vs. ambient air temperature and airflow rates for converter mounted vertically with air flowing from pin 1 to pin 3, MOSFET temperature $\leq 120^\circ\text{C}$, $V_{in} = 48\text{ V}$, 1" Heatsink.

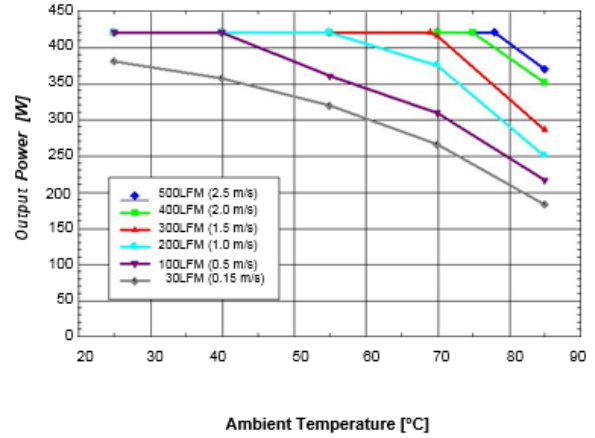

Figure 23. Available output current vs. ambient air temperature and airflow rates for converter mounted vertically with air flowing from pin 1 to pin 3, MOSFET temperature $\leq 120^\circ\text{C}$, $V_{in} = 48\text{ V}$, 1" Heatsink.

Figures 24 & 25 with 1" Finned Heatsink, $T_c \leq 125^\circ\text{C}$.

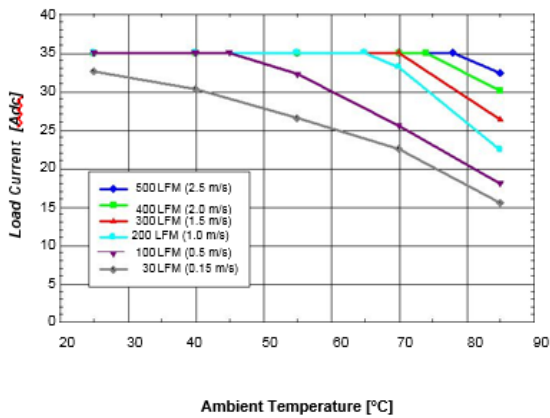

Figure 24. Available output current vs. ambient air temperature and airflow rates for converter mounted vertically with air flowing from pin 1 to pin 3, MOSFET temperature $\leq 125^\circ\text{C}$, $V_{in} = 48\text{ V}$, 1" Heatsink.

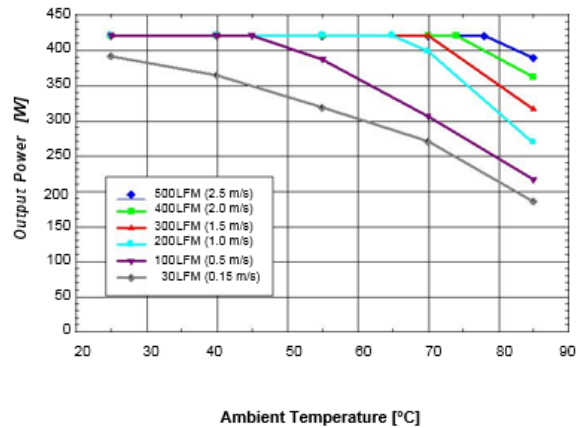

Figure 25. Available output power vs. ambient air temperature and airflow rates for converter mounted vertically with air flowing from pin 1 to pin 3, MOSFET temperature $\leq 125^\circ\text{C}$, $V_{in} = 48\text{ V}$, 1" Heatsink.

Figures 26 & 27 Coldplate Cooling $T_C \leq 120^\circ\text{C}$.

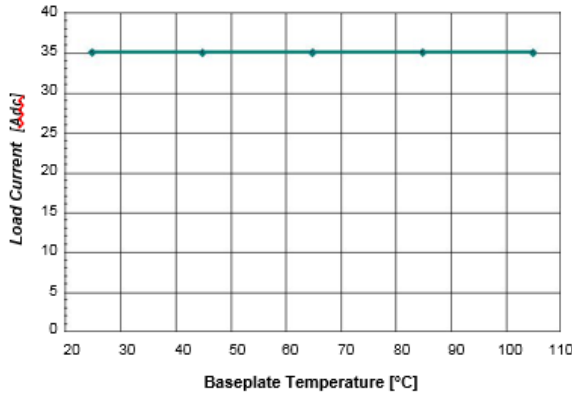

Figure 26. Current derating of QME48T35120 converter with baseplate option and coldplate cooling. (Conditions: Air velocity $\geq 30\text{LFM}$ ($\approx 0.15\text{m/s}$), $V_{in} = 48\text{ V}$, $T_B \leq 85^\circ\text{C}$, $T_C \leq 120^\circ\text{C}$. No thermal derating required.

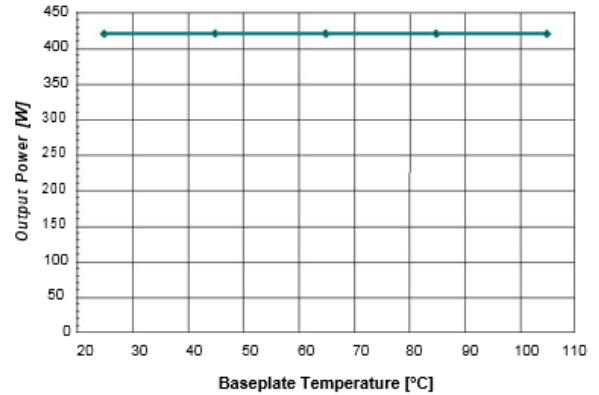

Figure 27. Power derating of QME48T35120 converter with baseplate option and coldplate cooling. (Conditions: Air velocity $\geq 30\text{LFM}$ ($\approx 0.15\text{m/s}$), $V_{in} = 48\text{ V}$, $T_B \leq 85^\circ\text{C}$, $T_C \leq 120^\circ\text{C}$. No thermal derating required.

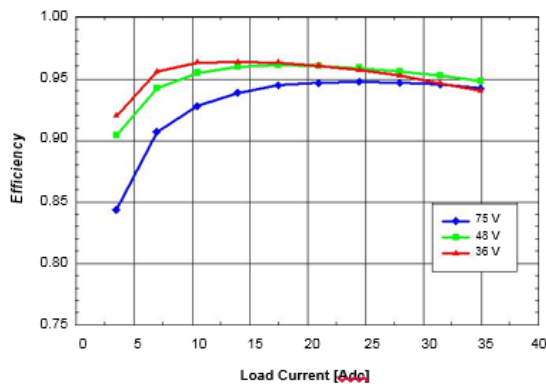

Figure 28. Efficiency vs. load current and input voltage for converter w/o baseplate mounted vertically with air flowing from pin 3 to pin 1 at a rate of 300 LFM (1.5 m/s) and $T_a = 25^\circ\text{C}$.

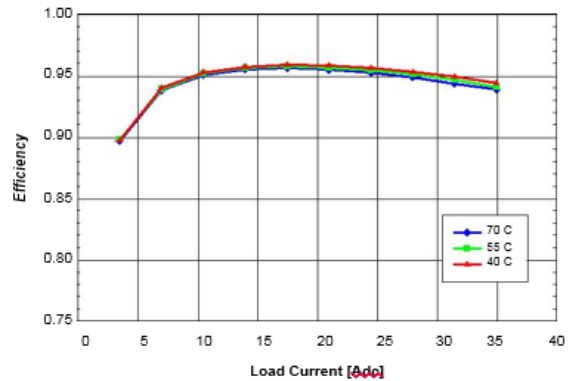

Figure 29. Efficiency vs. load current and ambient temperature for converter w/o baseplate mounted vertically with $V_{in} = 48\text{V}$ and air flowing from pin 3 to pin 1 at a rate of 200 LFM (1.0m/s).

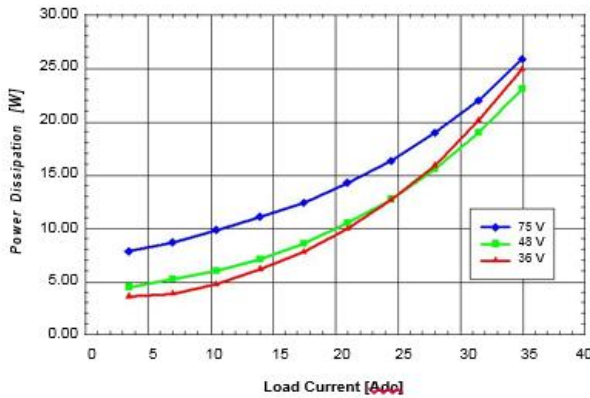

Figure 30. Power dissipation vs. load current and input voltage for converter w/o baseplate mounted vertically with air flowing from pin 3 to pin 1 at a rate of 300 LFM (1.5 m/s) and $T_a = 25\text{ }^\circ\text{C}$.

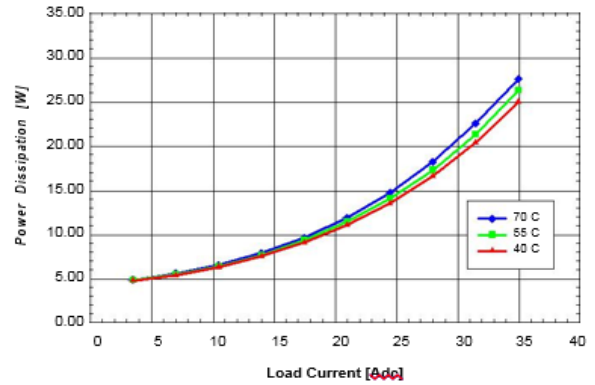

Figure 31. Power dissipation vs. load current and ambient temperature for converter w/o baseplate mounted vertically with $V_{in} = 48\text{ V}$ and air flowing from pin 3 to pin 1 at a rate of 200 LFM (1.0 m/s).

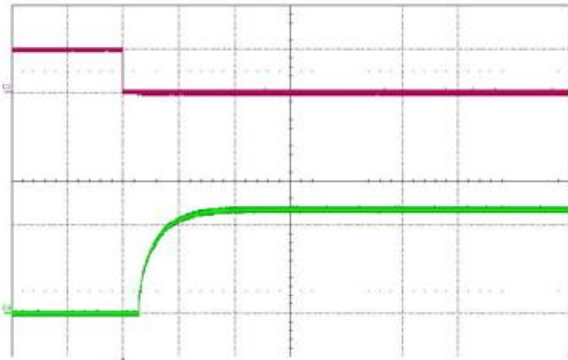

Figure 32. Turn-on transient at full rated load current (resistive) with no output capacitor at $V_{in} = 48\text{ V}$, triggered via ON/OFF pin. Top trace: ON/OFF signal (5 V/div.). Bottom trace: output voltage (5 V/div.). Time scale: 5 ms/div.

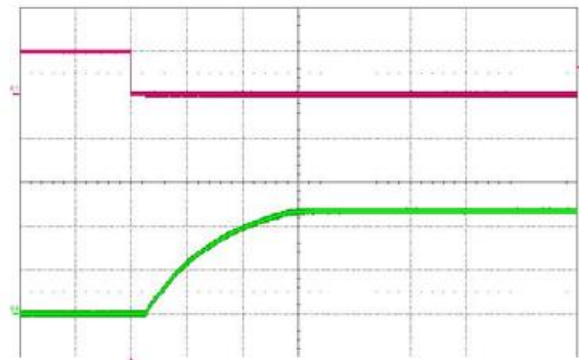

Figure 33. Turn-on transient at full rated load current (resistive) plus 20,000 μF at $V_{in} = 48\text{ V}$, triggered via ON/OFF pin. Top trace: ON/OFF signal (5 V/div.). Bottom trace: output voltage (5 V/div.). Time scale: 5 ms/div

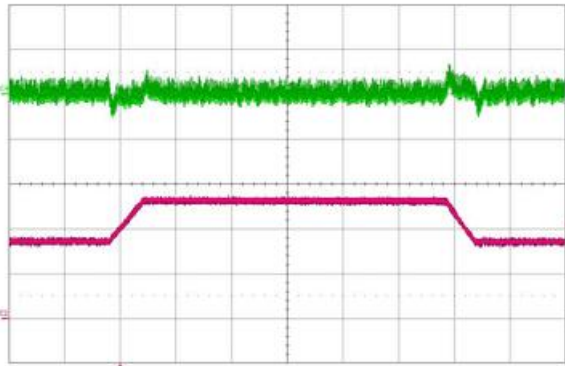

Figure 34. Output voltage response to load current step-change (17.5 A – 26.25 A – 17.5 A) at $V_{in} = 48\text{ V}$. Top trace: output voltage (100 mV/div.). Bottom trace: load current (10 A/div.). Current slew rate: 0.1 A/ μs . $C_o = 1\text{ }\mu\text{F}$ ceramic + 10 μF tantalum. Time scale: 200 μs /div.

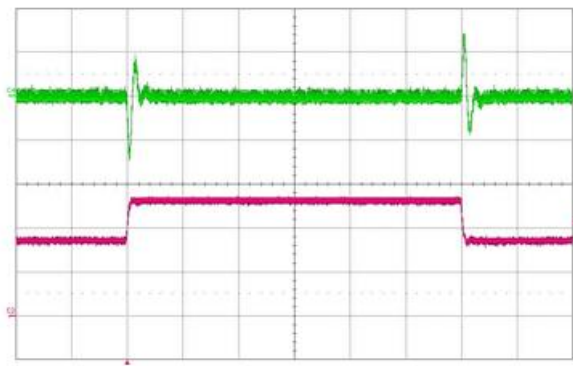

Figure 35. Output voltage response to load current step-change (17.5 A – 26.25 A – 17.5 A) at $V_{in} = 48\text{ V}$. Top trace: output voltage (200 mV/div.). Bottom trace: load current (10 A/div.). Current slew rate: 1 A/ μs . $C_o = 1\text{ }\mu\text{F}$ ceramic + 10 μF tantalum. Time scale: 200 μs /div.

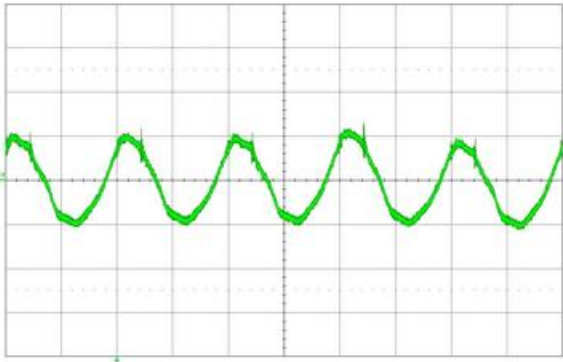

Figure 36. Output voltage ripple (20 mV/div.) at full rated load current into a resistive load with $C_o = 10 \mu\text{F}$ tantalum + $1 \mu\text{F}$ ceramic and $V_{in} = 48 \text{ V}$. Time scale: $2 \mu\text{s}/\text{div}$.

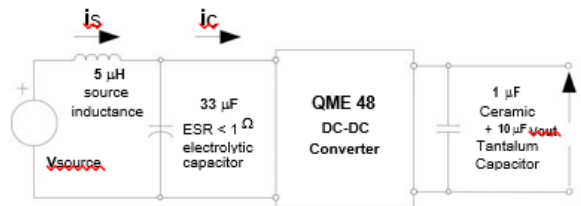

Figure 37. Test setup for measuring input reflected ripple currents, i_c and i_s .

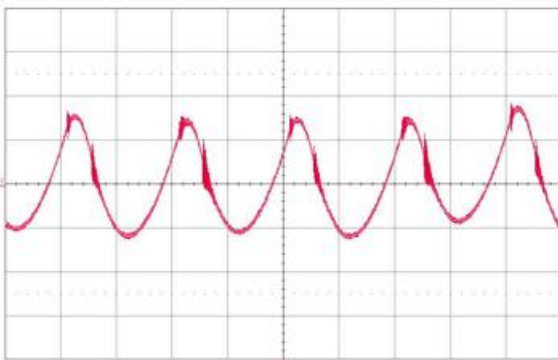

Figure 38. Input reflected ripple current, i_c (500 mA/div.), measured at input terminals at full rated load current and $V_{in} = 48 \text{ V}$. Refer to Fig. 37 for test setup. Time scale: $2 \mu\text{s}/\text{div}$.

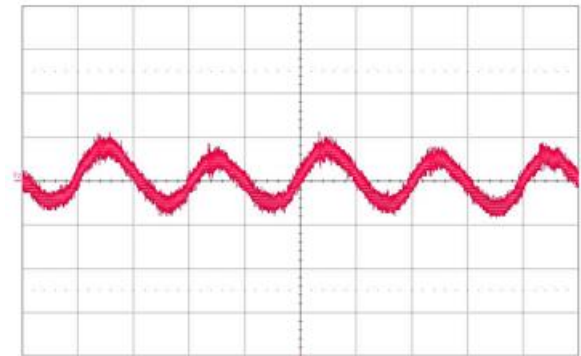

Figure 39. Input reflected ripple current, i_s (50 mA/div.), measured through $5 \mu\text{H}$ at the source at full rated load current and $V_{in} = 48 \text{ V}$. Refer to Fig. 37 for test setup. Time scale: $2 \mu\text{s}/\text{div}$.

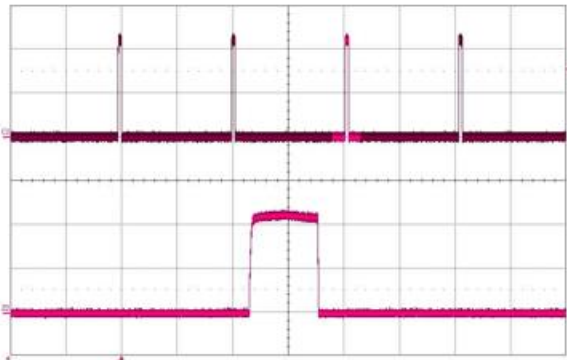

Figure 40. Load current (top trace, $20 \text{ A}/\text{div}$., $100 \text{ ms}/\text{div}$) into a $10 \text{ m}\Omega$ short circuit during restart, at $V_{in} = 48 \text{ V}$. Bottom trace ($20 \text{ A}/\text{div}$., $100 \text{ ms}/\text{div}$.) is an expansion of the on-time portion of the top trace.

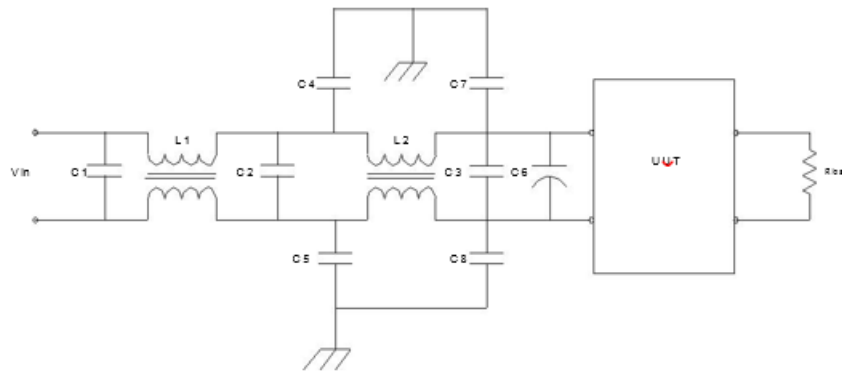

Figure 41. Typical input EMI filter circuit to attenuate conducted emissions.

COMPONENT DESCRIPTION	DESCRIPTION
C1, C2, C3	2 x 1uF, 100 V Ceramic Capacitor
C4, C5, C7, C8	4700pF Ceramic Capacitor
C6	100uF, 100 V Electrolytic Capacitor
L1, L2	0.59mH, P0469NL Pulse Eng. Or, equiv

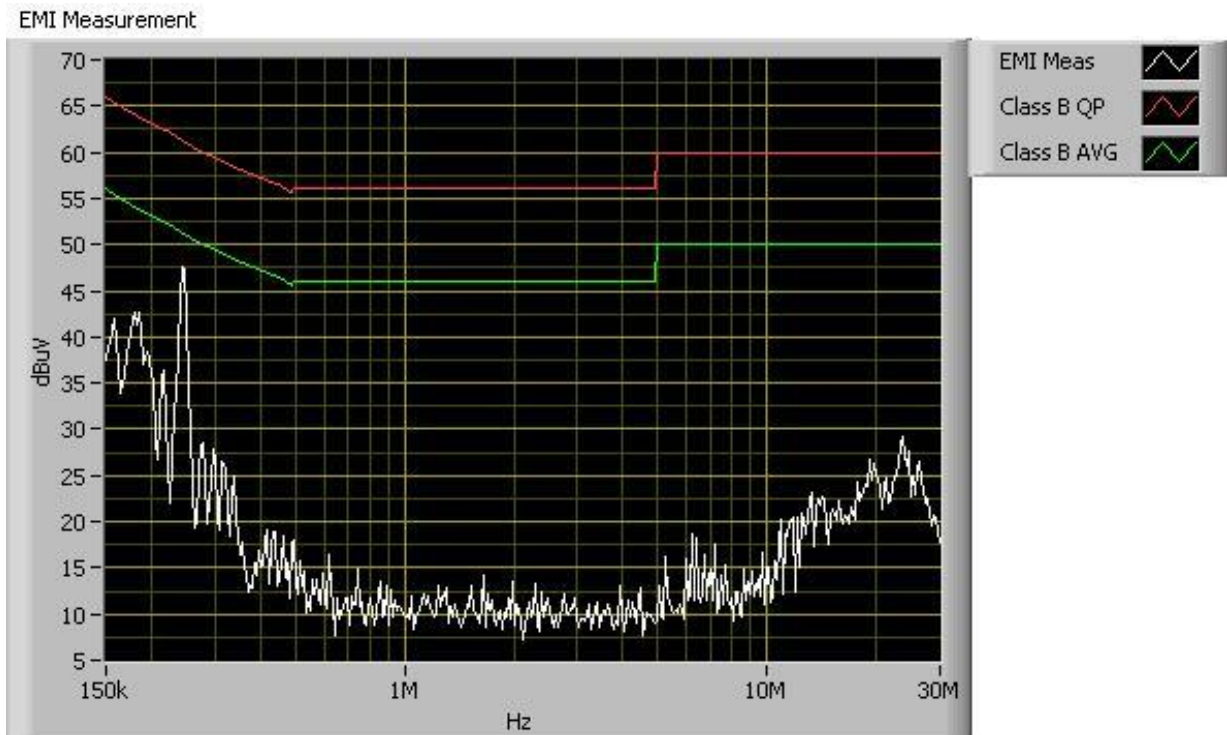
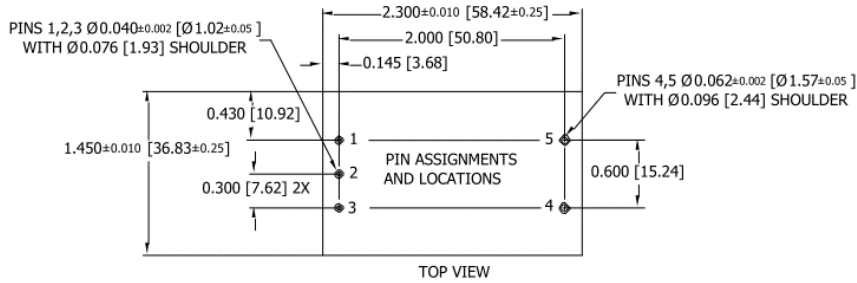

Figure 42. Input conducted emissions measurement (Typ.) of QME48T35120 with input filter shown in Figure 41. Conditions: $V_{IN}=48VDC$, $I_{OUT} = 35AMPS$

5. MECHANICAL PARAMETERS

QME48T35120 Pinout (Trough-hole)



PAD/PIN CONNECTIONS	
Pad/Pin #	Function
1	Vin (+)
2	ON/OFF
3	Vin (-)
4	Vout (-)
5	Vout (+)

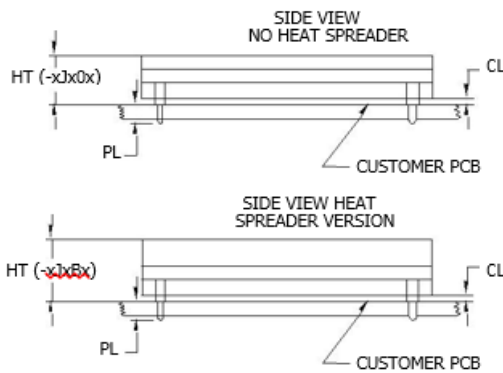

- All dimensions are in inches [mm]
- Pins 1 – 3 are Ø 0.040" [1.02] with Ø 0.076" [1.93] shoulder
- Pins 4 and 5 are Ø 0.062" [1.57] with Ø 0.096" [2.44] shoulder
- Pin Material: Brass Alloy 360
- Pin Finish: Tin over Nickel
- Heatsink Mounting Screw: 3 in lb maximum torque

Height [HT]	Minimum Clearance [CL]	Special Features
0.430" [10.4] Max	0.028" [0.71]	0
J 0.500" +/- 0.020 [12.70 +/- 0.51]	0.028" [0.71]	B

Pin Option	Pin Length [PL]
	±0.005 [±0.13]
A	0.188 [4.78]
B	0.145 [3.68]
C	0.110 [2.79]

Baseplate (Heat Spreader) Interface

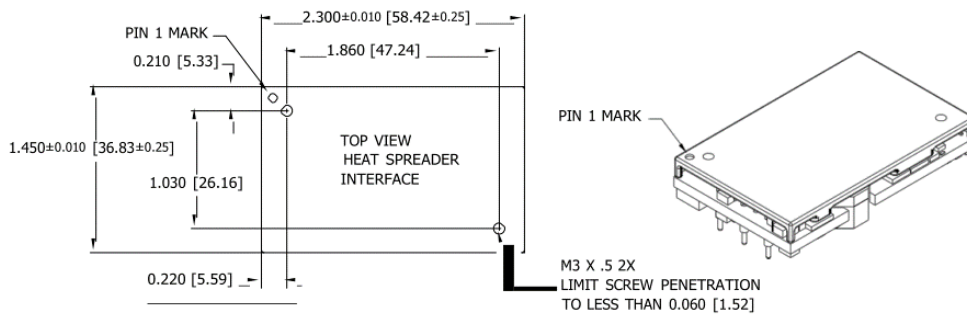

6. ORDERING INFORMATION

Product Series	Input Voltage	Mounting Scheme	Rated Load Current	Output Voltage	ON/OFF Logic	Maximum Height [HT]	Pin Length [PL]	Special Features	RoHS	Suffix	
QME	48	T	35	120	-	N	J	B	0	G	S 377
Quarter-Brick Format	36-75 V	Trough hole	35 A	120 ⇒ 12 V	N ⇒ Negative P ⇒ Positive	J ⇒ 0.430" for - xJx0x J ⇒ 0.520" for - xJxBx	A ⇒ 0.188" B ⇒ 0.145" C ⇒ 0.110"	0 ⇒ STD B ⇒ Baseplate option	No Suffix ⇒ RoHS lead-solder-exemption compliant G ⇒ RoHS compliant for all six substances	S 377 ⇒ Specially made to suit the dynamic load application	

The example above describes P/N QME48T35120-NJB0G: 36-75 V input, through-hole mounting, 35 A @ 12 V output, negative ON/OFF logic, a maximum height of 0.430", 0.145" pin length, and standard (no baseplate), RoHS compliant for all 6 substances. Consult factory for availability of other options.

7. REVISION HISTORY

DATE	REVISION	DESCRIPTION OF CHANGE	ECO/MCO REFERENCE NO.
2019-Jul-26	AC	Page 19: Suffix S377 added to Ordering Information Table referring to added capability of 10000 µF start up.	C95653

For more information on these products consult: tech.support@psbel.com

NUCLEAR AND MEDICAL APPLICATIONS - Products are not designed or intended for use as critical components in life support systems, equipment used in hazardous environments, or nuclear control systems.

TECHNICAL REVISIONS - The appearance of products, including safety agency certifications pictured on labels, may change depending on the date manufactured. Specifications are subject to change without notice.



Asia-Pacific
+86 755 298 85888

Europe, Middle East
+353 61 225 977

North America
+1 408 785 5200

Компания «Океан Электроники» предлагает заключение долгосрочных отношений при поставках импортных электронных компонентов на взаимовыгодных условиях!

Наши преимущества:

- Поставка оригинальных импортных электронных компонентов напрямую с производств Америки, Европы и Азии, а так же с крупнейших складов мира;
- Широкая линейка поставок активных и пассивных импортных электронных компонентов (более 30 млн. наименований);
- Поставка сложных, дефицитных, либо снятых с производства позиций;
- Оперативные сроки поставки под заказ (от 5 рабочих дней);
- Экспресс доставка в любую точку России;
- Помощь Конструкторского Отдела и консультации квалифицированных инженеров;
- Техническая поддержка проекта, помощь в подборе аналогов, поставка прототипов;
- Поставка электронных компонентов под контролем ВП;
- Система менеджмента качества сертифицирована по Международному стандарту ISO 9001;
- При необходимости вся продукция военного и аэрокосмического назначения проходит испытания и сертификацию в лаборатории (по согласованию с заказчиком);
- Поставка специализированных компонентов военного и аэрокосмического уровня качества (Xilinx, Altera, Analog Devices, Intersil, Interpoint, Microsemi, Actel, Aeroflex, Peregrine, VPT, Syfer, Eurofarad, Texas Instruments, MS Kennedy, Miteq, Cobham, E2V, MA-COM, Hittite, Mini-Circuits, General Dynamics и др.);

Компания «Океан Электроники» является официальным дистрибьютором и эксклюзивным представителем в России одного из крупнейших производителей разъемов военного и аэрокосмического назначения «JONHON», а так же официальным дистрибьютором и эксклюзивным представителем в России производителя высокотехнологичных и надежных решений для передачи СВЧ сигналов «FORSTAR».



JONHON

«JONHON» (основан в 1970 г.)

Разъемы специального, военного и аэрокосмического назначения:

(Применяются в военной, авиационной, аэрокосмической, морской, железнодорожной, горно- и нефтедобывающей отраслях промышленности)

«FORSTAR» (основан в 1998 г.)

ВЧ соединители, коаксиальные кабели, кабельные сборки и микроволновые компоненты:

(Применяются в телекоммуникациях гражданского и специального назначения, в средствах связи, РЛС, а так же военной, авиационной и аэрокосмической отраслях промышленности).



Телефон: 8 (812) 309-75-97 (многоканальный)

Факс: 8 (812) 320-03-32

Электронная почта: ocean@oceanchips.ru

Web: <http://oceanchips.ru/>

Адрес: 198099, г. Санкт-Петербург, ул. Калинина, д. 2, корп. 4, лит. А