



Low-Power, +3V/+5V, 400MHz Single-Supply Op Amps with Rail-to-Rail Outputs

MAX4414-MAX4419

General Description

The MAX4414–MAX4419 operational amplifiers combine high-speed performance, low distortion, and ultra-low supply current. Consuming just 1.6mA of supply current per amplifier, these devices operate from a single +2.7V to +5.5V supply, have Rail-to-Rail® outputs, and exhibit a common-mode input voltage range that extends from 100mV below ground to within 1.5V of the positive supply rail.

The MAX4414/MAX4416/MAX4418 single/dual/quad op amps are unity-gain stable and achieve a 400MHz -3dB bandwidth with a 200V/μs slew rate. The MAX4415/MAX4417/MAX4419 single/dual/quad op amps are compensated for closed-loop gains of +5V/V or greater and achieve a 150MHz -3dB bandwidth with a 470V/μs slew rate. The combination of high-speed, ultra-low power, and low-distortion makes the MAX4414–MAX4419 ideal for low-power/low-voltage, high-speed portable systems such as video, communications, and instrumentation.

The MAX4414/MAX4415 single and MAX4416/MAX4417 dual amplifiers are available in space-saving 8-pin μMAX and SO packages, while the MAX4418/MAX4419 quad amplifiers are available in a 14-pin TSSOP package.

Applications

Battery-Powered Instruments
 Portable Communications
 Keyless Entry Systems
 Cellular Telephones
 Video Line Drivers
 Baseband Applications

Selector Guide

PART	NO. OF AMPS	MINIMUM GAIN (V/V)	-3dB BANDWIDTH (MHz)	SLEW RATE (V/μs)
MAX4414	1	1	400	200
MAX4415	1	5	150	470
MAX4416	2	1	400	200
MAX4417	2	5	150	470
MAX4418	4	1	400	200
MAX4419	4	5	150	470

Rail-to-Rail is a registered trademark of Nippon Motorola, Ltd.
 Pin Configurations appear at end of data sheet.

Features

- ◆ Ultra-Low 1.6mA Supply Current
- ◆ Single +3V/+5V Operation
- ◆ High Speed
 - 400MHz -3dB Bandwidth (MAX4414/MAX4416/MAX4418)
 - 200V/μs Slew Rate (MAX4414/MAX4416/MAX4418)
 - 150MHz -3dB Bandwidth (MAX4415/MAX4417/MAX4419)
 - 470V/μs Slew Rate (MAX4415/MAX4417/MAX4419)
- ◆ Rail-to-Rail Outputs
- ◆ Input Common-Mode Range Extends Beyond V_{EE}
- ◆ Low Differential Gain/Phase: 0.03%/0.15°
- ◆ Low Distortion at 5MHz (MAX4414/MAX4416/MAX4418)
 - 93dBc SFDR
 - 0.003% Total Harmonic Distortion
- ◆ Low Cost

Ordering Information

PART	TEMP. RANGE	PIN-PACKAGE
MAX4414EUA	-40°C to +85°C	8 μMAX
MAX4414ESA	-40°C to +85°C	8 SO
MAX4415EUA	-40°C to +85°C	8 μMAX
MAX4415ESA	-40°C to +85°C	8 SO

Ordering information continued at end of data sheet.

Typical Operating Characteristics



Low-Power, +3V/+5V, 400MHz Single-Supply Op Amps with Rail-to-Rail Outputs

ABSOLUTE MAXIMUM RATINGS

Supply Voltage (V_{CC} to V_{EE}).....	+6V	Operating Temperature Range	-40°C to +85°C
Differential Input Voltage	±2.5V	Junction Temperature	+150°C
IN_- , IN_+ , OUT_-	($V_{CC} + 0.3V$) to ($V_{EE} - 0.3V$)	Storage Temperature Range	-65°C to +150°C
Current into Input Pins	±20mA	Lead Temperature (soldering, 10s)	+300°C
Output Short-Circuit Duration to V_{CC} or V_{EE}	Continuous		
Continuous Power Dissipation ($T_A = +70^\circ C$)			
8-Pin μ MAX (derate 4.5mW/°C above +70°C)	362mW		
8-Pin SO (derate 5.9mW/°C above +70°C).....	471mW		
14-Pin TSSOP (derate 9.1mW/°C above +70°C)	727mW		

Stresses beyond those listed under "Absolute Maximum Ratings" may cause permanent damage to the device. These are stress ratings only, and functional operation of the device at these or any other conditions beyond those indicated in the operational sections of the specifications is not implied. Exposure to absolute maximum rating conditions for extended periods may affect device reliability.

DC ELECTRICAL CHARACTERISTICS

($V_{CC} = +2.7V$ to $+5.5V$, $V_{CM} = V_{CC}/2 - 0.75V$, $V_{EE} = 0$, $R_L = \infty$ to $V_{CC}/2$, $V_{OUT} = V_{CC}/2$, $T_A = T_{MIN}$ to T_{MAX} , unless otherwise noted. Typical values are at $T_A = +25^\circ C$.) (Note 1)

PARAMETER	SYMBOL	CONDITIONS	MIN	TYP	MAX	UNITS
Operating Supply Voltage Range	V_S	Guaranteed by PSRR test	2.7		5.5	V
Quiescent Supply Current (per Amplifier)	I_S	$V_{CC} = +5V$		1.6	3	mA
		$V_{CC} = +3V$		1.4	2.6	
Input Common-Mode Voltage Range	V_{CM}	Guaranteed by CMRR test	$V_{EE} - 0.1$		$V_{CC} - 1.5$	V
Input Offset Voltage	V_{OS}			0.5	6	mV
Input Offset Voltage Temperature	TC_{VOS}			3		$\mu V/^\circ C$
Input Offset Voltage Matching		MAX4416-MAX4419		±1		mV
Input Bias Current	I_B			1.3	4	μA
Input Offset Current	I_{OS}			0.1	0.7	μA
Input Resistance	R_{IN}	Differential mode, $-0.04V \leq (V_{IN+} - V_{IN-}) \leq +0.04V$		60		k Ω
		Common mode, $V_{EE} - 0.1V < V_{CM} < V_{CC} - 1.5V$		16		M Ω
Common-Mode Rejection Ratio	CMRR	$V_{EE} - 0.1V < V_{CM} < V_{CC} - 1.5V$	65	94		dB
Open-Loop Gain	AVOL	$V_{CC} = +5V$	$+0.2V \leq V_{OUT} \leq +4.8V$, $R_L = 10k\Omega$	78	93	dB
			$+0.4V \leq V_{OUT} \leq +4.6V$, $R_L = 1k\Omega$	68	80	
			$+0.3V \leq V_{OUT} \leq +4.4V$, $R_L = 1k\Omega$ to V_{EE}	66	80	
			$+1V \leq V_{OUT} \leq +4V$, $R_L = 150\Omega$		65	
		$V_{CC} = +3V$	$+0.2V \leq V_{OUT} \leq +2.8V$, $R_L = 10k\Omega$	75	90	
			$+0.25V \leq V_{OUT} \leq +2.75V$, $R_L = 1k\Omega$	65	78	
			$+0.2V \leq V_{OUT} \leq +2.5V$, $R_L = 1k\Omega$ to V_{EE}	63	75	
			$+0.5V \leq V_{OUT} \leq +2.5V$, $R_L = 150\Omega$		62	

Low-Power, +3V/+5V, 400MHz Single-Supply Op Amps with Rail-to-Rail Outputs

MAX4414-MAX4419

DC ELECTRICAL CHARACTERISTICS (continued)

($V_{CC} = +2.7V$ to $+5.5V$, $V_{CM} = V_{CC}/2 - 0.75V$, $V_{EE} = 0$, $R_L = \infty$ to $V_{CC}/2$, $V_{OUT} = V_{CC}/2$, $T_A = T_{MIN}$ to T_{MAX} , unless otherwise noted. Typical values are at $T_A = +25^\circ C$.) (Note 1)

PARAMETER	SYMBOL	CONDITIONS		MIN	TYP	MAX	UNITS
Output Voltage Swing	V_{OUT}	$V_{CC} = +5V$	$R_L = 10k\Omega$	$V_{CC} - V_{OH}$	0.085	0.375	V
				$V_{OL} - V_{EE}$	0.015	0.100	
			$R_L = 1k\Omega$	$V_{CC} - V_{OH}$	0.105	0.400	
				$V_{OL} - V_{EE}$	0.035	0.125	
			$R_L = 150\Omega$	$V_{CC} - V_{OH}$	0.385		
				$V_{OL} - V_{EE}$	0.150		
		$V_{CC} = +3V$	$R_L = 10k\Omega$	$V_{CC} - V_{OH}$	0.060	0.365	
				$V_{OL} - V_{EE}$	0.010	0.090	
			$R_L = 1k\Omega$	$V_{CC} - V_{OH}$	0.075	0.390	
				$V_{OL} - V_{EE}$	0.025	0.115	
			$R_L = 150\Omega$	$V_{CC} - V_{OH}$	0.275		
				$V_{OL} - V_{EE}$	0.070		
Output Current	I_{OUT}	$R_L = 20\Omega$ connected to V_{CC} or V_{EE} , $V_{CC} = +5V$		± 25	± 75		mA
Output Short-Circuit Current	I_{SC}	Sinking or sourcing			± 85		mA
Power-Supply Rejection Ratio	PSRR	$V_{CC} = +2.7V$ to $+5.5V$, $V_{CM} = 0$, $V_{OUT} = 2V$		60	77		dB

AC ELECTRICAL CHARACTERISTICS

($V_{CC} = +5V$, $V_{EE} = 0$, $V_{CM} = +1.75V$, $R_L = 1k\Omega$ connected to $V_{CC}/2$, $C_L = 5pF$, $A_{VCL} = +1V/V$, $T_A = +25^\circ C$, unless otherwise noted.)

PARAMETER	SYMBOL	CONDITIONS		MIN	TYP	MAX	UNITS
Small Signal -3dB Bandwidth	BW_{SS}	$V_{OUT} = 100mVp-p$	MAX4414/MAX4416/ MAX4418, $A_V = +1V/V$		400		MHz
			MAX4415/MAX4417/ MAX4419, $A_V = +5V/V$		150		
Large Signal -3dB Bandwidth	BW_{LS}	$V_{OUT} = 2Vp-p$	MAX4414/MAX4416/ MAX4418, $A_V = +1V/V$		32		MHz
			MAX4415/MAX4417/ MAX4419, $A_V = +5V/V$		75		
Bandwidth for 0.1dB Flatness	$BW_{0.1dB}$	$V_{OUT} = 100mVp-p$	MAX4414/MAX4416/ MAX4418, $A_V = +1V/V$		43		MHz
			MAX4415/MAX4417/ MAX4419, $A_V = +5V/V$		16		
		$V_{OUT} = 2Vp-p$	MAX4414/MAX4416/ MAX4418, $A_V = +1V/V$		22		
			MAX4415/MAX4417/ MAX4419, $A_V = +5V/V$		28		

Low-Power, +3V/+5V, 400MHz Single-Supply Op Amps with Rail-to-Rail Outputs

AC ELECTRICAL CHARACTERISTICS (continued)

($V_{CC} = +5V$, $V_{EE} = 0$, $V_{CM} = +1.75V$, $R_L = 1k\Omega$ connected to $V_{CC}/2$, $C_L = 5pF$, $A_{VCL} = +1V/V$, $T_A = +25^\circ C$, unless otherwise noted.)

PARAMETER	SYMBOL	CONDITIONS		MIN	TYP	MAX	UNITS
Slew Rate	SR	$V_{OUT} = 2V$ step	MAX4414/MAX4416/ MAX4418, $A_V = +1V/V$		200		V/ μs
			MAX4415/MAX4417/ MAX4419, $A_V = +5V/V$		470		
Rise/Fall Time	t_R, t_F	$V_{OUT} = 2V$ step, 10% to 90%	MAX4414/MAX4416/ MAX4418, $A_V = +1V/V$		14		ns
			MAX4415/MAX4417/ MAX4419, $A_V = +5V/V$		5		
Settling Time	$t_S 1\%$	$V_{OUT} = 2V$ step	MAX4414/MAX4416/ MAX4418, $A_V = +1V/V$		100		ns
			MAX4415/MAX4417/ MAX4419, $A_V = +5V/V$		120		
	$t_S 0.1\%$	$V_{OUT} = 2V$ step	MAX4414/MAX4416/ MAX4418, $A_V = +1V/V$		150		
			MAX4415/MAX4417/ MAX4419, $A_V = +5V/V$		160		
Spurious-Free Dynamic Range	SFDR	$V_{CC} = +5V$, $f_C = 5MHz$	MAX4414/MAX4416/ MAX4418, $A_V = +1V/V$, $V_{OUT} = 1V_{p-p}$		-84		dBc
			MAX4415/MAX4417/ MAX4419, $A_V = +5V/V$, $V_{OUT} = 2V_{p-p}$		-76		
		$V_{CC} = +3V$, $f_C = 5MHz$	MAX4414/MAX4416/ MAX4418, $A_V = +1V/V$, $V_{OUT} = 1V_{p-p}$		-93		
			MAX4415/MAX4417/ MAX4419, $A_V = +5V/V$, $V_{OUT} = 2V_{p-p}$		-79		

Low-Power, +3V/+5V, 400MHz Single-Supply Op Amps with Rail-to-Rail Outputs

MAX4414-MAX4419

AC ELECTRICAL CHARACTERISTICS (continued)

($V_{CC} = +5V$, $V_{EE} = 0$, $V_{CM} = +1.75V$, $R_L = 1k\Omega$ connected to $V_{CC}/2$, $C_L = 5pF$, $A_{VCL} = +1V/V$, $T_A = +25^\circ C$, unless otherwise noted.)

PARAMETER	SYMBOL	CONDITIONS		MIN	TYP	MAX	UNITS
2 nd Harmonic Distortion	SFDR	$V_{CC} = +5V$, $f_c = 5MHz$	MAX4414/MAX4416/ MAX4418, $A_V = +1V/V$, $V_{OUT} = 1Vp-p$		-84		dBc
			MAX4415/MAX4417/ MAX4419, $A_V = +5V/V$, $V_{OUT} = 2Vp-p$		-76		
		$V_{CC} = +3V$, $f_c = 5MHz$	MAX4414/MAX4416/ MAX4418, $A_V = +1V/V$, $V_{OUT} = 1Vp-p$		-93		
			MAX4415/MAX4417/ MAX4419, $A_V = +5V/V$, $V_{OUT} = 2Vp-p$		-65		
3 rd Harmonic Distortion	SFDR	$V_{CC} = +5V$, $f_c = 5MHz$	MAX4414/MAX4416/ MAX4418, $A_V = +1V/V$, $V_{OUT} = 1Vp-p$		-95		dBc
			MAX4415/MAX4417/ MAX4419, $A_V = +5V/V$, $V_{OUT} = 2Vp-p$		-80		
		$V_{CC} = +3V$, $f_c = 5MHz$	MAX4414/MAX4416/ MAX4418, $A_V = +1V/V$, $V_{OUT} = 1Vp-p$		-95		
			MAX4415/MAX4417/ MAX4419, $A_V = +5V/V$, $V_{OUT} = 2Vp-p$		-67		

Low-Power, +3V/+5V, 400MHz Single-Supply Op Amps with Rail-to-Rail Outputs

AC ELECTRICAL CHARACTERISTICS (continued)

($V_{CC} = +5V$, $V_{EE} = 0$, $V_{CM} = +1.75V$, $R_L = 1k\Omega$ connected to $V_{CC}/2$, $C_L = 5pF$, $A_{VCL} = +1V/V$, $T_A = +25^\circ C$, unless otherwise noted.)

PARAMETER	SYMBOL	CONDITIONS		MIN	TYP	MAX	UNITS
Total Harmonic Distortion	SFDR	$V_{CC} = +5V$, $f_C = 5MHz$	MAX4414/MAX4416/ MAX4418, $A_V = +1V/V$, $V_{OUT} = 1Vp-p$		0.007		%
			MAX4415/MAX4417/ MAX4419, $A_V = +5V/V$, $V_{OUT} = 2Vp-p$		0.02		
		$V_{CC} = +3V$, $f_C = 5MHz$	MAX4414/MAX4416/ MAX4418, $A_V = +1V/V$, $V_{OUT} = 1Vp-p$		0.003		
			MAX4415/MAX4417/ MAX4419, $A_V = +5V/V$, $V_{OUT} = 2Vp-p$		0.01		
Two-Tone, Third-Order Intermodulation Distortion	IP3	$f_C = 10MHz$, $f_2 = 9.9MHz$			-67		dBc
Differential Gain Error	DG	$R_L = 150\Omega$, NTSC	MAX4414/MAX4416/ MAX4418, $A_V = +1V/V$		0.03		%
			MAX4414/MAX4416/ MAX4418, $A_V = +2V/V$		0.04		
			MAX4415/MAX4417/ MAX4419, $A_V = +5V/V$		0.05		
Differential Phase Error	DP	$R_L = 150\Omega$, NTSC	MAX4414/MAX4416/ MAX4418, $A_V = +1V/V$		0.15		degrees
			MAX4414/MAX4416/ MAX4418, $A_V = +2V/V$		0.25		
			MAX4415/MAX4417/ MAX4419, $A_V = +5V/V$		0.35		

Low-Power, +3V/+5V, 400MHz Single-Supply Op Amps with Rail-to-Rail Outputs

MAX4414-MAX4419

AC ELECTRICAL CHARACTERISTICS (continued)

($V_{CC} = +5V$, $V_{EE} = 0$, $V_{CM} = +1.75V$, $R_L = 1k\Omega$ connected to $V_{CC}/2$, $C_L = 5pF$, $A_{VCL} = +1V/V$, $T_A = +25^\circ C$, unless otherwise noted.)

PARAMETER	SYMBOL	CONDITIONS	MIN	TYP	MAX	UNITS
Gain Matching		MAX4416-MAX4419, $V_{OUT} = 100mVp-p$, $f \leq 10MHz$		0.1		dB
Phase Matching		MAX4416-MAX4419, $V_{OUT} = 100mVp-p$, $f \leq 10MHz$		0.1		degrees
Input Noise-Voltage Density	e_n	$f = 10kHz$		10		nV/\sqrt{Hz}
Input Noise-Current Density	I_n	$f = 10kHz$		0.6		pA/\sqrt{Hz}
Input Capacitance	C_{IN}			1.8		pF
Output Impedance	Z_{OUT}	$f = 1MHz$		0.5		Ω
Capacitive Load Drive		No sustained oscillations		120		pF
Power-Up 1% Settling Time (Note 2)				1.2	100	μs
Crosstalk	X_{TALK}	MAX4416-MAX4419, $f = 10MHz$, $V_{OUT} = 2Vp-p$		-72		dB

Note 1: All devices are 100% production tested at $T_A = +25^\circ C$. Specifications over temperature are guaranteed by design.

Note 2: Guaranteed by design.

Typical Operating Characteristics

($V_{CC} = +5V$, $V_{EE} = 0$, $V_{CM} = +1.75V$, $A_{VCL} = +1V/V$ (MAX4414/MAX4416/MAX4418), $A_{VCL} = +5V/V$ (MAX4415/MAX4417/MAX4419), $R_L = 1k\Omega$ to $V_{CC}/2$, $C_L = 5pF$, $T_A = +25^\circ C$, unless otherwise noted.)

SUPPLY CURRENT vs. SUPPLY VOLTAGE (PER AMPLIFIER)



SMALL-SIGNAL GAIN vs. FREQUENCY



**MAX4414/MAX4416/MAX4418
SMALL-SIGNAL GAIN WITH CAPACITIVE LOAD vs. FREQUENCY**



Low-Power, +3V/+5V, 400MHz Single-Supply Op Amps with Rail-to-Rail Outputs

Typical Operating Characteristics (continued)

($V_{CC} = +5V$, $V_{EE} = 0$, $V_{CM} = +1.75V$, $A_{VCL} = +1V/V$ (MAX4414/MAX4416/MAX4418), $A_{VCL} = +5V/V$ (MAX4415/MAX4417/MAX4419), $R_L = 1k\Omega$ to $V_{CC}/2$, $C_L = 5pF$, $T_A = +25^\circ C$, unless otherwise noted.)

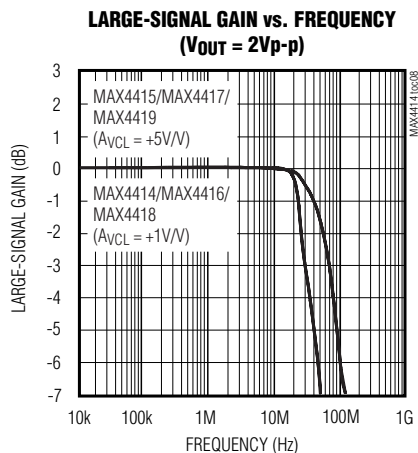
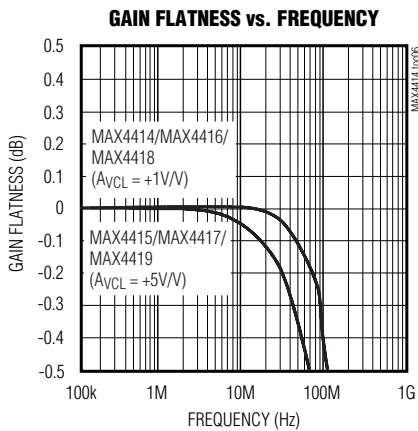

Low-Power, +3V/+5V, 400MHz Single-Supply Op Amps with Rail-to-Rail Outputs

Typical Operating Characteristics (continued)

($V_{CC} = +5V$, $V_{EE} = 0$, $V_{CM} = +1.75V$, $A_{VCL} = +1V/V$ (MAX4414/MAX4416/MAX4418), $A_{VCL} = +5V/V$ (MAX4415/MAX4417/MAX4419), $R_L = 1k\Omega$ to $V_{CC}/2$, $C_L = 5pF$, $T_A = +25^\circ C$, unless otherwise noted.)

MAX4414-MAX4419

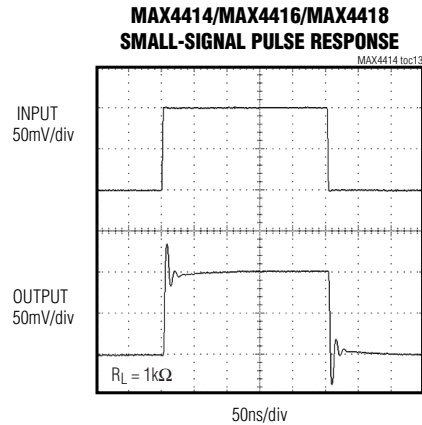

Low-Power, +3V/+5V, 400MHz Single-Supply Op Amps with Rail-to-Rail Outputs

Typical Operating Characteristics (continued)

($V_{CC} = +5V$, $V_{EE} = 0$, $V_{CM} = +1.75V$, $A_{VCL} = +1V/V$ (MAX4414/MAX4416/MAX4418), $A_{VCL} = +5V/V$ (MAX4415/MAX4417/MAX4419), $R_L = 1k\Omega$ to $V_{CC}/2$, $C_L = 5pF$, $T_A = +25^\circ C$, unless otherwise noted.)

**MAX4415/MAX4417/MAX4419
LARGE-SIGNAL PULSE RESPONSE**



**MAX4414/MAX4416/MAX4418
LARGE-SIGNAL PULSE RESPONSE**



**MAX4415/MAX4417/MAX4419
LARGE-SIGNAL PULSE RESPONSE**

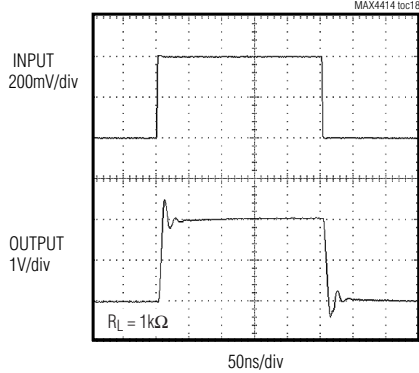

**MAX4414/MAX4416/MAX4418
SMALL-SIGNAL PULSE RESPONSE**

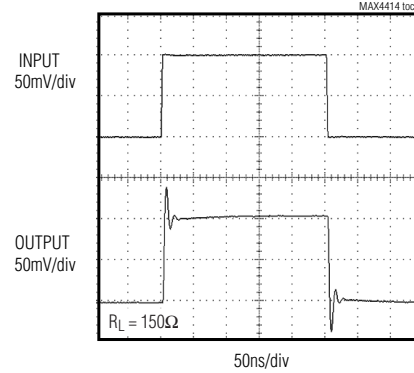

**MAX4415/MAX4417/MAX4419
SMALL-SIGNAL PULSE RESPONSE**

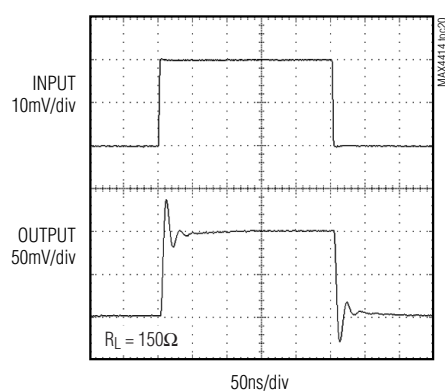

**MAX4414/MAX4416/MAX4418
LARGE-SIGNAL PULSE RESPONSE**

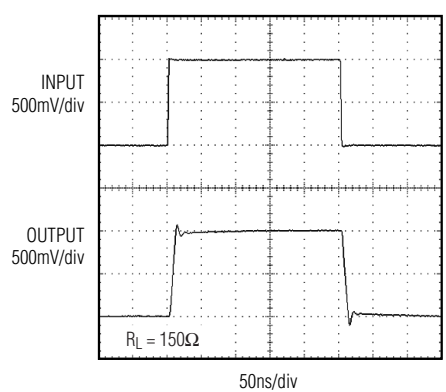

Low-Power, +3V/+5V, 400MHz Single-Supply Op Amps with Rail-to-Rail Outputs

MAX4414-MAX4419

Typical Operating Characteristics (continued)

($V_{CC} = +5V$, $V_{EE} = 0$, $V_{CM} = +1.75V$, $A_{VCL} = +1V/V$ (MAX4414/MAX4416/MAX4418), $A_{VCL} = +5V/V$ (MAX4415/MAX4417/MAX4419), $R_L = 1k\Omega$ to $V_{CC}/2$, $C_L = 5pF$, $T_A = +25^\circ C$, unless otherwise noted.)

**MAX4415/MAX4417/MAX4419
LARGE-SIGNAL PULSE RESPONSE**



**MAX4414/MAX4416/MAX4418
SMALL-SIGNAL PULSE RESPONSE
($C_{LOAD} = 15pF$)**

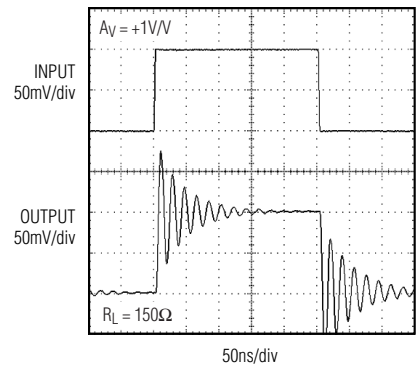

**MAX4415/MAX4417/MAX4419
SMALL-SIGNAL PULSE RESPONSE
($C_{LOAD} = 15pF$)**

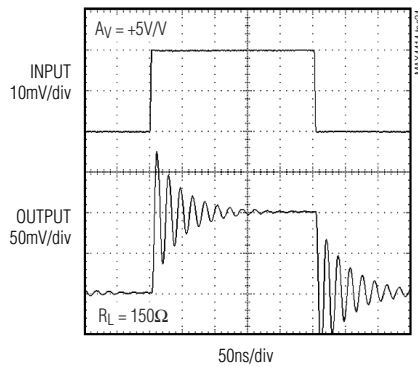

**CLOSED-LOOP OUTPUT IMPEDANCE
vs. FREQUENCY**

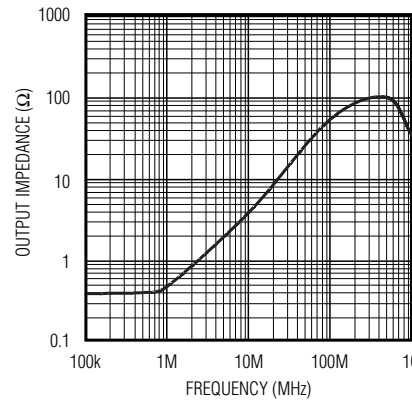

**MAX4416-MAX4419
CROSSTALK vs. FREQUENCY**



**SMALL-SIGNAL BANDWIDTH
vs. LOAD RESISTANCE**



Low-Power, +3V/+5V, 400MHz Single-Supply Op Amps with Rail-to-Rail Outputs

Typical Operating Characteristics (continued)

($V_{CC} = +5V$, $V_{EE} = 0$, $V_{CM} = +1.75V$, $A_{VCL} = +1V/V$ (MAX4414/MAX4416/MAX4418), $A_{VCL} = +5V/V$ (MAX4415/MAX4417/MAX4419), $R_L = 1k\Omega$ to $V_{CC}/2$, $C_L = 5pF$, $T_A = +25^\circ C$, unless otherwise noted.)

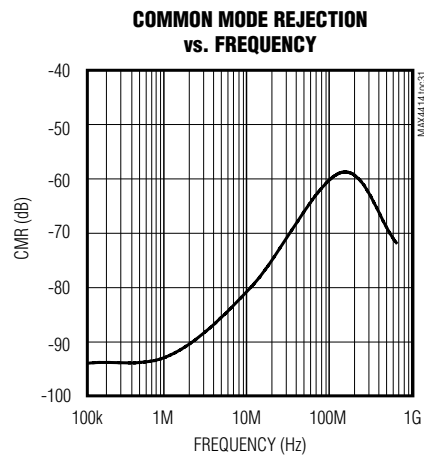

Low-Power, +3V/+5V, 400MHz Single-Supply Op Amps with Rail-to-Rail Outputs

Typical Operating Characteristics (continued)

($V_{CC} = +5V$, $V_{EE} = 0$, $V_{CM} = +1.75V$, $A_{VCL} = +1V/V$ (MAX4414/MAX4416/MAX4418), $A_{VCL} = +5V/V$ (MAX4415/MAX4417/MAX4419), $R_L = 1k\Omega$ to $V_{CC}/2$, $C_L = 5pF$, $T_A = +25^\circ C$, unless otherwise noted.)

MAX4414-MAX4419

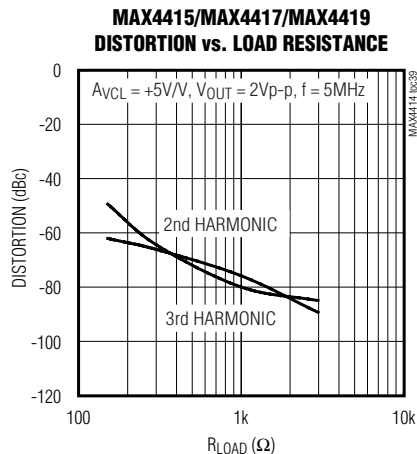

Low-Power, +3V/+5V, 400MHz Single-Supply Op Amps with Rail-to-Rail Outputs

Typical Operating Characteristics (continued)

($V_{CC} = +5V$, $V_{EE} = 0$, $V_{CM} = +1.75V$, $A_{VCL} = +1V/V$ (MAX4414/MAX4416/MAX4418), $A_{VCL} = +5V/V$ (MAX4415/MAX4417/MAX4419), $R_L = 1k\Omega$ to $V_{CC}/2$, $C_L = 5pF$, $T_A = +25^\circ C$, unless otherwise noted.)



Low-Power, +3V/+5V, 400MHz Single-Supply Op Amps with Rail-to-Rail Outputs

Pin Description

MAX4414-MAX4419

PIN			NAME	FUNCTION
MAX4414 MAX4415	MAX4416 MAX4417	MAX4418 MAX4419		
1, 5, 8	—	—	N.C.	No Connection. Not internally connected.
3	—	—	IN+	Amplifier Noninverting Input
—	3	3	INA+	Amplifier A Noninverting Input
—	5	5	INB+	Amplifier B Noninverting Input
—	—	10	INC+	Amplifier C Noninverting Input
—	—	12	IND+	Amplifier D Noninverting Input
2	—	—	IN-	Amplifier Inverting Input
—	2	2	INA-	Amplifier A Inverting Input
—	6	6	INB-	Amplifier B Inverting Input
—	—	9	INC-	Amplifier C Inverting Input
—	—	13	IND-	Amplifier D Inverting Input
4	4	11	V _{EE}	Negative Power Supply
6	—	—	OUT	Amplifier Output
—	1	1	OUTA	Amplifier A Output
—	7	7	OUTB	Amplifier B Output
—	—	8	OUTC	Amplifier C Output
—	—	14	OUTD	Amplifier D Output
7	8	4	V _{CC}	Positive Power Supply

Detailed Description

The MAX4414–MAX4419 single-supply, rail-to-rail, voltage-feedback amplifiers achieve high slew rates and bandwidths, while consuming only 1.6mA of supply current per amplifier. Excellent harmonic distortion and differential gain/phase performance make these amplifiers an ideal choice for a wide variety of video and RF signal-processing applications.

Internal feedback around the output stage ensures low open-loop output impedance, reducing gain sensitivity to load variations. This feedback also produces demand-driven current bias to the output transistors.

Rail-to-Rail Outputs, Ground-Sensing Input

The MAX4414–MAX4419 input common-mode range extends from (V_{EE} - 0.1V) to (V_{CC} - 1.5V) with excellent common-mode rejection. Beyond this range, the amplifier output is a nonlinear function of the input, but does not undergo phase reversal or latchup.

The output swings to within 105mV of either power-supply rail with a 1k Ω load. Input ground sensing and rail-to-rail output substantially increase the dynamic range. With a symmetric input in a single +5V application, the

input can swing 3.6Vp-p, and the output can swing 4.6Vp-p with minimal distortion.

Output Capacitive Loading and Stability

The MAX4414–MAX4419 are optimized for AC performance. They are not designed to drive highly reactive loads. Such loads decrease phase margin and may produce excessive ringing and oscillation. The use of an isolation resistor eliminates this problem (Figure 1). Figure 2 is a graph of the Optimal Isolation Resistor (R_{ISO}) vs. Capacitive Load.

The Small-Signal Gain vs. Frequency with Capacitive Load and No Isolation Resistor graph in the *Typical Operating Characteristics* shows how a capacitive load causes excessive peaking of the amplifier's frequency response if the capacitor is not isolated from the amplifier by a resistor. A small isolation resistor (usually 20 Ω to 30 Ω) placed before the reactive load prevents ringing and oscillation. At higher capacitive loads, AC performance is controlled by the interaction of the load capacitance and the isolation resistor. The Small-Signal Gain vs. Frequency with Capacitive Load and 22 Ω Isolation Resistor graph shows the effect of a 22 Ω isolation resistor on closed-loop response.

Low-Power, +3V/+5V, 400MHz Single-Supply Op Amps with Rail-to-Rail Outputs

Coaxial cable and other transmission lines are easily driven when properly terminated at both ends with their characteristic impedance. Driving back-terminated transmission lines essentially eliminates the line's capacitance.

Applications Information

Choosing Resistor Values

Unity-Gain Configuration

The MAX4414/MAX4416/MAX4418 are internally compensated for unity gain. When configured for unity gain, the devices require a 24Ω feedback resistor (R_F). This resistor improves AC response by reducing the Q of the parallel LC circuit formed by the parasitic feedback capacitance and inductance.

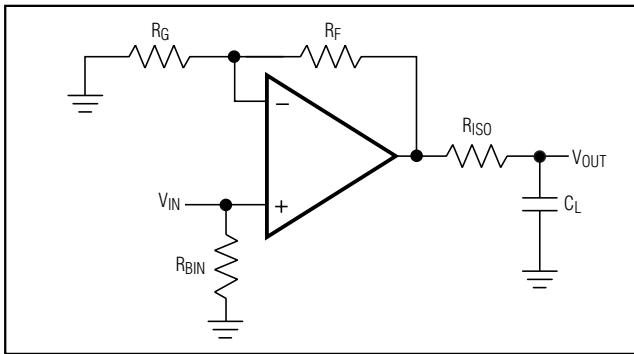

Figure 1. Driving a Capacitive Load Through an Isolation Resistor

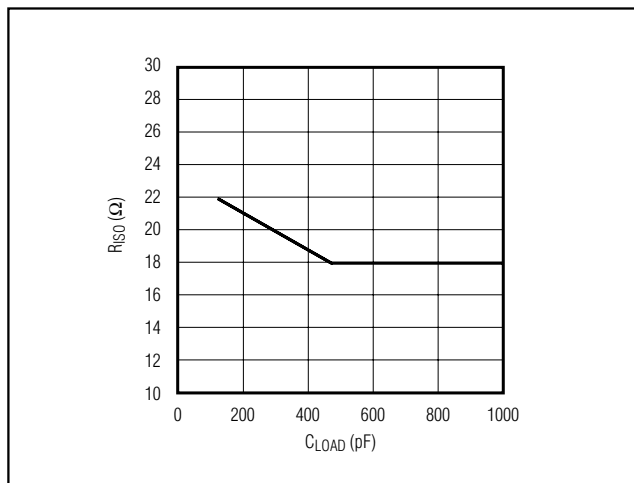

Figure 2. Capacitive Load vs. Isolation Resistance

Inverting and Noninverting Configurations

Select the gain-setting feedback (R_F) and input (R_G) resistor values that best fit the application. Large resistor values increase voltage noise and interact with the amplifier's input and PC board capacitance. This can generate undesirable poles and zeros and decrease bandwidth or cause oscillations. For example, a noninverting gain-of-two configuration (R_F = R_G) using 1kΩ resistors, combined with 1.8pF of amplifier input capacitance and 1pF of PC board capacitance, causes a pole at 114MHz. Since this pole is within the amplifier bandwidth, it jeopardizes stability. Reducing the 1kΩ resistors to 100Ω extends the pole frequency to 1.14GHz, but could limit output swing by adding 200Ω in parallel with the amplifier's load resistor.

Note: For high gain applications where output offset voltage is a consideration, choose R_S to be equal to the parallel combination of R_F and R_G (Figures 3a and 3b):

$$R_S = \frac{R_F \times R_G}{R_F + R_G}$$

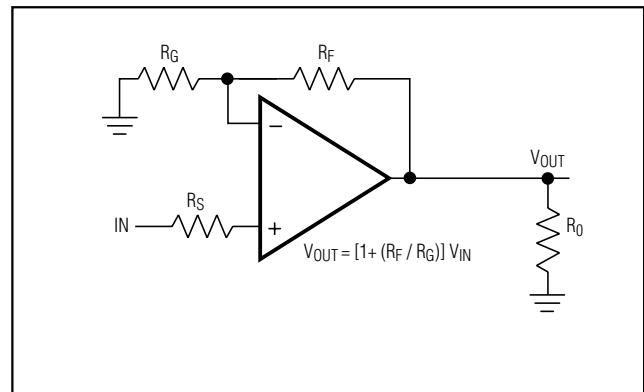

Figure 3a. Noninverting Gain Configuration

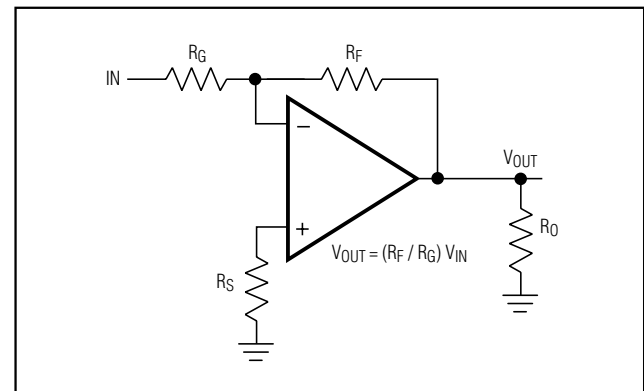

Figure 3b. Inverting Gain Configuration

Low-Power, +3V/+5V, 400MHz Single-Supply Op Amps with Rail-to-Rail Outputs

MAX4414-MAX4419

Video Line Driver

The MAX4414–MAX4419 are designed to minimize differential gain error and differential phase error to 0.03%/0.15° respectively, making them ideal for driving video loads. See Figure 4.

Active Filters

The low distortion and high bandwidth of the MAX4414–MAX4419 make them ideal for use in active filter circuits. Figure 5 is a 15MHz lowpass, multiple-feedback active filter using the MAX4414.

$$\text{GAIN} = \frac{R_2}{R_1}$$

$$f_0 = \frac{1}{2\pi} \times \sqrt{\frac{1}{R_2 \times R_3 \times C_1 \times C_2}}$$

$$Q = \frac{C_2}{\frac{1}{R_1} + \frac{1}{R_2} + \frac{1}{R_3}}$$

ADC Input Buffer

Input buffer amplifiers can be a source of significant errors in high-speed ADC applications. The input buffer is usually required to rapidly charge and discharge the ADC's input, which is often capacitive (see *Output Capacitive Loading and Stability*). In addition, since a high-speed ADC's input impedance often changes very rapidly during the conversion cycle, measurement accuracy must be maintained using an amplifier with very low output impedance at high frequencies. The combination of high speed, fast slew rate, low noise, and a low and stable distortion over load make the MAX4414–MAX4419 ideally suited for use as buffer amplifiers in high-speed ADC applications.

Layout and Power-Supply Bypassing

These amplifiers operate from a single +2.7V to +5.5V power supply. Bypass VCC to ground with a 0.1µF capacitor as close to the pin as possible.



Figure 4. Video Line Driver

Maxim recommends using microstrip and stripline techniques to obtain full bandwidth. Design the PC board for a frequency greater than 1GHz to prevent amplifier performance degradation due to board parasitics. Avoid large parasitic capacitances at inputs and outputs. Whether or not a constant-impedance board is used, observe the following guidelines:

- Do not use wire-wrap boards due to their high inductance.
- Do not use IC sockets because of the increased parasitic capacitance and inductance.
- Use surface-mount instead of through-hole components for better high-frequency performance.
- Use a PC board with at least two layers; it should be as free from voids as possible.
- Keep signal lines as short and as straight as possible. Do not make 90° turns; round all corners.

Low-Power, +3V/+5V, 400MHz Single-Supply Op Amps with Rail-to-Rail Outputs

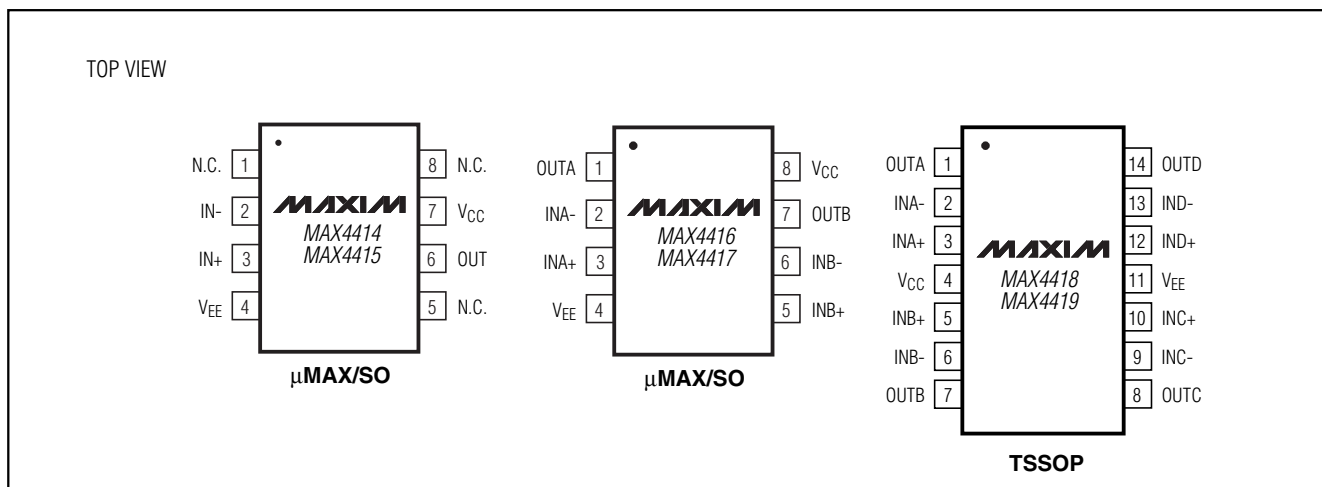

Figure 5. Multiple-Feedback Lowpass Filter

Low-Power, +3V/+5V, 400MHz Single-Supply Op Amps with Rail-to-Rail Outputs

Pin Configurations

MAX4414-MAX4419



Ordering Information (continued)

PART	TEMP. RANGE	PIN-PACKAGE
MAX4416EUA	-40°C to +85°C	8 μMAX
MAX4416ESA	-40°C to +85°C	8 SO
MAX4417EUA	-40°C to +85°C	8 μMAX
MAX4417ESA	-40°C to +85°C	8 SO
MAX4418EUD	-40°C to +85°C	14 TSSOP
MAX4419EUD	-40°C to +85°C	14 TSSOP

Chip Information

MAX4414/MAX4415 TRANSISTOR COUNT: 95

MAX4416/MAX4417 TRANSISTOR COUNT: 184

MAX4418/MAX4419 TRANSISTOR COUNT: 268

PROCESS: Bipolar

Low-Power, +3V/+5V, 400MHz Single-Supply Op Amps with Rail-to-Rail Outputs

Package Information

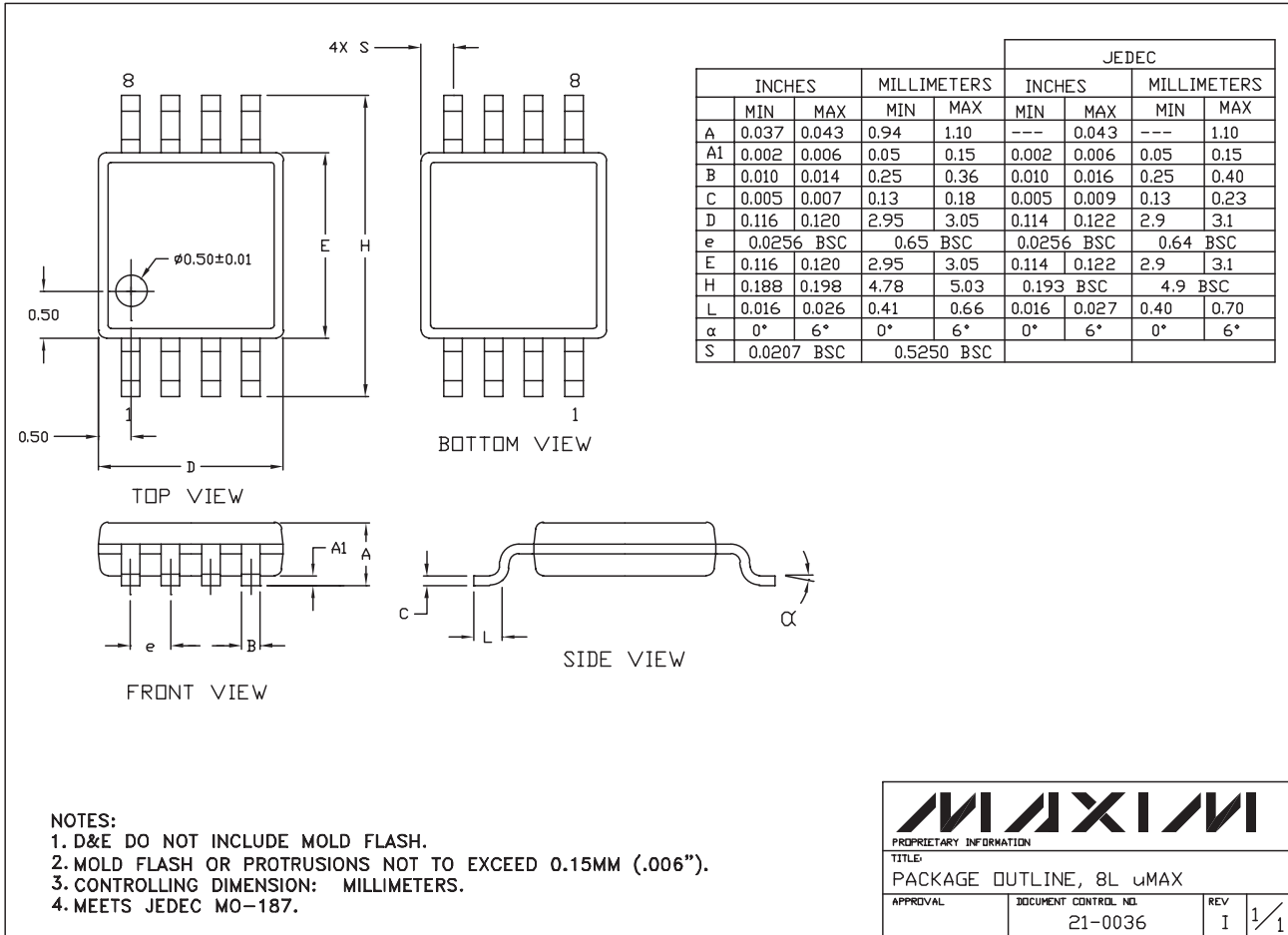

8LUMAXD.EPS

MAXIM
 PROPRIETARY INFORMATION
 TITLE:
 PACKAGE OUTLINE, 8L uMAX
 APPROVAL: _____ DOCUMENT CONTROL NO: 21-0036 REV: I 1/1

Low-Power, +3V/+5V, 400MHz Single-Supply Op Amps with Rail-to-Rail Outputs

Package Information (continued)

MAX4414-MAX4419

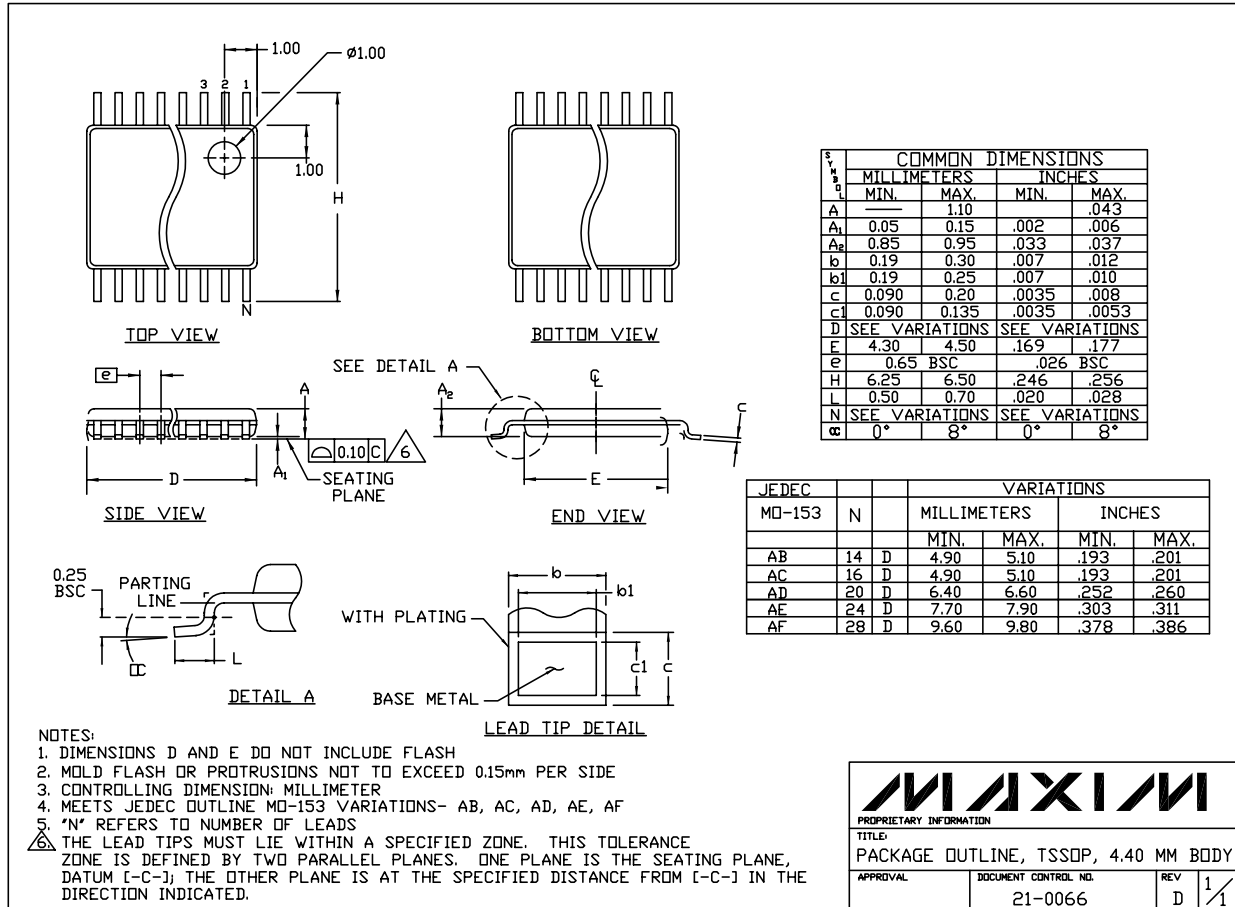

Low-Power, +3V/+5V, 400MHz Single-Supply Op Amps with Rail-to-Rail Outputs

Package Information (continued)



Maxim cannot assume responsibility for use of any circuitry other than circuitry entirely embodied in a Maxim product. No circuit patent licenses are implied. Maxim reserves the right to change the circuitry and specifications without notice at any time.

22 **Maxim Integrated Products, 120 San Gabriel Drive, Sunnyvale, CA 94086 408-737-7600**

Компания «Океан Электроники» предлагает заключение долгосрочных отношений при поставках импортных электронных компонентов на взаимовыгодных условиях!

Наши преимущества:

- Поставка оригинальных импортных электронных компонентов напрямую с производств Америки, Европы и Азии, а так же с крупнейших складов мира;
- Широкая линейка поставок активных и пассивных импортных электронных компонентов (более 30 млн. наименований);
- Поставка сложных, дефицитных, либо снятых с производства позиций;
- Оперативные сроки поставки под заказ (от 5 рабочих дней);
- Экспресс доставка в любую точку России;
- Помощь Конструкторского Отдела и консультации квалифицированных инженеров;
- Техническая поддержка проекта, помощь в подборе аналогов, поставка прототипов;
- Поставка электронных компонентов под контролем ВП;
- Система менеджмента качества сертифицирована по Международному стандарту ISO 9001;
- При необходимости вся продукция военного и аэрокосмического назначения проходит испытания и сертификацию в лаборатории (по согласованию с заказчиком);
- Поставка специализированных компонентов военного и аэрокосмического уровня качества (Xilinx, Altera, Analog Devices, Intersil, Interpoint, Microsemi, Actel, Aeroflex, Peregrine, VPT, Syfer, Eurofarad, Texas Instruments, MS Kennedy, Miteq, Cobham, E2V, MA-COM, Hittite, Mini-Circuits, General Dynamics и др.);

Компания «Океан Электроники» является официальным дистрибьютором и эксклюзивным представителем в России одного из крупнейших производителей разъемов военного и аэрокосмического назначения «JONHON», а так же официальным дистрибьютором и эксклюзивным представителем в России производителя высокотехнологичных и надежных решений для передачи СВЧ сигналов «FORSTAR».



JONHON

«JONHON» (основан в 1970 г.)

Разъемы специального, военного и аэрокосмического назначения:

(Применяются в военной, авиационной, аэрокосмической, морской, железнодорожной, горно- и нефтедобывающей отраслях промышленности)

«FORSTAR» (основан в 1998 г.)

ВЧ соединители, коаксиальные кабели, кабельные сборки и микроволновые компоненты:

(Применяются в телекоммуникациях гражданского и специального назначения, в средствах связи, РЛС, а так же военной, авиационной и аэрокосмической отраслях промышленности).



Телефон: 8 (812) 309-75-97 (многоканальный)

Факс: 8 (812) 320-03-32

Электронная почта: ocean@oceanchips.ru

Web: <http://oceanchips.ru/>

Адрес: 198099, г. Санкт-Петербург, ул. Калинина, д. 2, корп. 4, лит. А