

EL8302

500MHz Rail-to-Rail Amplifier

FN7348
Rev 2.00
May 6, 2005

The EL8302 represents a triple rail-to-rail amplifier with a -3dB bandwidth of 500MHz and slew rate of 600V/ μ s. Running off a very low supply current of 5.6mA per channel, the EL8302 also features inputs that go to 0.15V below the V_{S-} rail.

The EL8302 includes a fast-acting disable/power-down circuit. With a 25ns disable and a 200ns enable, the EL8302 is ideal for multiplexing applications.

The EL8302 is designed for a number of general purpose video, communication, instrumentation, and industrial applications. The EL8302 is available in an 16-pin SO and 16-pin QSOP packages and is specified for operation over the -40°C to +85°C temperature range.

Pinout

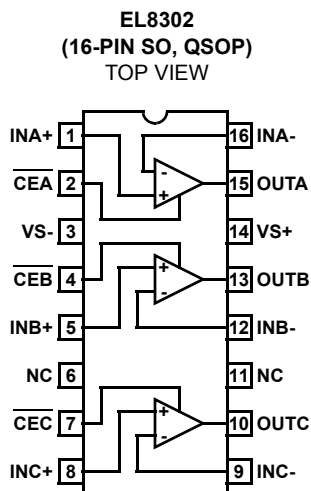

Features

- 500MHz -3dB bandwidth
- 600V/ μ s slew rate
- Low supply current = 5.6mA per amplifier
- Supplies from 3V to 5.5V
- Rail-to-rail output
- Input to 0.15V below V_{S-}
- Fast 25ns disable
- Low cost
- Pb-Free available (RoHS compliant)

Applications

- Video amplifiers
- Portable/hand-held products
- Communications devices

Ordering Information

PART NUMBER	PACKAGE	TAPE & REEL	PKG. DWG. #
EL8302IS	16-Pin SO	-	MDP0027
EL8302IS-T7	16-Pin SO	7"	MDP0027
EL8302IS-T13	16-Pin SO	13"	MDP0027
EL8302ISZ (See Note)	16-Pin SO (Pb-free)	-	MDP0027
EL8302ISZ-T7 (See Note)	16-Pin SO (Pb-free)	7"	MDP0027
EL8302ISZ-T13 (See Note)	16-Pin SO (Pb-free)	13"	MDP0027
EL8302IU	16-Pin QSOP	-	MDP0040
EL8302IU-T7	16-Pin QSOP	7"	MDP0040
EL8302IU-T13	16-Pin QSOP	13"	MDP0040
EL8302IUZ (See Note)	16-Pin QSOP (Pb-free)	-	MDP0040
EL8302IUZ-T7 (See Note)	16-Pin QSOP (Pb-free)	7"	MDP0040
EL8302IUZ-T13 (See Note)	16-Pin QSOP (Pb-free)	13"	MDP0040

NOTE: Intersil Pb-free products employ special Pb-free material sets; molding compounds/die attach materials and 100% matte tin plate termination finish, which are RoHS compliant and compatible with both SnPb and Pb-free soldering operations. Intersil Pb-free products are MSL classified at Pb-free peak reflow temperatures that meet or exceed the Pb-free requirements of IPC/JEDEC J STD-020.

Absolute Maximum Ratings ($T_A = 25^\circ\text{C}$)

Supply Voltage from V_{S+} to V_{S-}	5.5V
Input Voltage	$V_{S+} + 0.3\text{V}$ to $V_{S-} - 0.3\text{V}$
Differential Input Voltage2V
Continuous Output Current	40mA

Power Dissipation	See Curves
Storage Temperature	-65°C to $+125^\circ\text{C}$
Ambient Operating Temperature	-40°C to $+85^\circ\text{C}$
Operating Junction Temperature	$+125^\circ\text{C}$

CAUTION: Stresses above those listed in "Absolute Maximum Ratings" may cause permanent damage to the device. This is a stress only rating and operation of the device at these or any other conditions above those indicated in the operational sections of this specification is not implied.

IMPORTANT NOTE: All parameters having Min/Max specifications are guaranteed. Typ values are for information purposes only. Unless otherwise noted, all tests are at the specified temperature and are pulsed tests, therefore: $T_J = T_C = T_A$

Electrical Specifications $V_{S+} = 5\text{V}$, $V_{S-} = \text{GND}$, $T_A = 25^\circ\text{C}$, $V_{CM} = 2.5\text{V}$, R_L to 2.5V, $A_V = 1$, Unless Otherwise Specified

PARAMETER	DESCRIPTION	CONDITIONS	MIN	TYP	MAX	UNIT
INPUT CHARACTERISTICS						
V_{OS}	Offset Voltage		-7	-0.8	+7	mV
TCV_{OS}	Offset Voltage Temperature Coefficient	Measured from T_{MIN} to T_{MAX}		3		$\mu\text{V}/^\circ\text{C}$
I_B	Input Bias Current	$V_{IN} = 0\text{V}$	-10	-6		μA
I_{OS}	Input Offset Current	$V_{IN} = 0\text{V}$		0.1	0.6	μA
TCI_{OS}	Input Bias Current Temperature Coefficient	Measured from T_{MIN} to T_{MAX}		2		$\text{nA}/^\circ\text{C}$
CMRR	Common Mode Rejection Ratio	$V_{CM} = -0.15\text{V}$ to $+3.5\text{V}$	70	95		dB
CMIR	Common Mode Input Range		$V_{S-} - 0.15$		$V_{S+} - 1.5$	V
R_{IN}	Input Resistance	Common Mode		7		$\text{M}\Omega$
C_{IN}	Input Capacitance			0.5		pF
AVOL	Open Loop Gain	$V_{OUT} = +1.5\text{V}$ to $+3.5\text{V}$, $R_L = 1\text{k}\Omega$ to GND	75	100		dB
		$V_{OUT} = +1.5\text{V}$ to $+3.5\text{V}$, $R_L = 150\Omega$ to GND		80		dB
OUTPUT CHARACTERISTICS						
R_{OUT}	Output Resistance	$A_V = +1$		30		$\text{m}\Omega$
V_{OP}	Positive Output Voltage Swing	$R_L = 1\text{k}\Omega$	4.85	4.9		V
		$R_L = 150\Omega$	4.65	4.7		V
V_{ON}	Negative Output Voltage Swing	$R_L = 150\Omega$		150	200	mV
		$R_L = 1\text{k}\Omega$		50	70	mV
I_{OUT}	Linear Output Current			65		mA
$I_{SC}(\text{source})$	Short Circuit Current	$R_L = 10\Omega$	50	80		mA
$I_{SC}(\text{sink})$	Short Circuit Current	$R_L = 10\Omega$	90	150		mA
POWER SUPPLY						
PSRR	Power Supply Rejection Ratio	$V_{S+} = 4.5\text{V}$ to 5.5V	70	95		dB
I_{S-ON}	Supply Current - Enabled per Amplifier			5.6	6.2	mA
I_{S-OFF}	Supply Current - Disabled per Amplifier			40	90	μA
ENABLE						
t_{EN}	Enable Time			200		ns
t_{DS}	Disable Time			25		ns
V_{IH-ENB}	$\overline{\text{ENABLE}}$ Pin Voltage for Power-up			0.8		V
V_{IL-ENB}	$\overline{\text{ENABLE}}$ Pin Voltage for Shut-down			2		V

Electrical Specifications $V_{S+} = 5V$, $V_{S-} = GND$, $T_A = 25^{\circ}C$, $V_{CM} = 2.5V$, R_L to 2.5V, $A_V = 1$, Unless Otherwise Specified

PARAMETER	DESCRIPTION	CONDITIONS	MIN	TYP	MAX	UNIT
I_{IH-ENB}	\overline{ENABLE} Pin Input Current High			8.6		μA
I_{IL-ENB}	\overline{ENABLE} Pin Input for Current Low			0.01		μA
AC PERFORMANCE						
BW	-3dB Bandwidth	$A_V = +1$, $R_F = 0\Omega$, $C_L = 1.5pF$		500		MHz
		$A_V = -1$, $R_F = 1k\Omega$, $C_L = 1.5pF$		140		MHz
		$A_V = +2$, $R_F = 1k\Omega$, $C_L = 1.5pF$		165		MHz
		$A_V = +10$, $R_F = 1k\Omega$, $C_L = 1.5pF$		18		MHz
BW	$\pm 0.1dB$ Bandwidth	$A_V = +1$, $R_F = 0\Omega$, $C_L = 1.5pF$		36		MHz
Peak	Peaking	$A_V = +1$, $R_L = 1k\Omega$, $C_L = 1.5pF$		1		dB
GBWP	Gain Bandwidth Product			200		MHz
PM	Phase Margin	$R_L = 1k\Omega$, $C_L = 1.5pF$		55		$^{\circ}$
SR	Slew Rate	$A_V = 2$, $R_L = 100\Omega$, $V_{OUT} = 0.5V$ to $4.5V$	500	600		$V/\mu s$
t_R	Rise Time	$2.5V_{STEP}$, 20% - 80%		4		ns
t_F	Fall Time	$2.5V_{STEP}$, 20% - 80%		2		ns
OS	Overshoot	200mV step		10		%
t_{PD}	Propagation Delay	200mV step		1		ns
t_S	0.1% Settling Time	200mV step		15		ns
dG	Differential Gain	$A_V = +2$, $R_F = 1k\Omega$, $R_L = 150\Omega$		0.01		%
dP	Differential Phase	$A_V = +2$, $R_F = 1k\Omega$, $R_L = 150\Omega$		0.01		$^{\circ}$
e_N	Input Noise Voltage	$f = 10kHz$		12		nV/\sqrt{Hz}
i_{N+}	Positive Input Noise Current	$f = 10kHz$		1.7		pA/\sqrt{Hz}
i_{N-}	Negative Input Noise Current	$f = 10kHz$		1.3		pA/\sqrt{Hz}
e_S	Channel Separation	$f = 100kHz$		95		dB

Pin Descriptions

PIN	NAME	FUNCTION
1, 5, 8	INA+, INB+, INC+	Non-inverting input for each channel
2, 4, 7	\overline{CEA} , \overline{CEB} , \overline{CEC}	Enable and disable input for each channel
3	VS-	Negative power supply
6, 11	NC	Not connected
9, 12, 16	INC-, INB-, INA-	Inverting input for each channel
10, 13, 15	OUTC, OUTB, OUTA	Amplifier output for each channel
14	VS+	Positive power supply

Typical Performance Curves

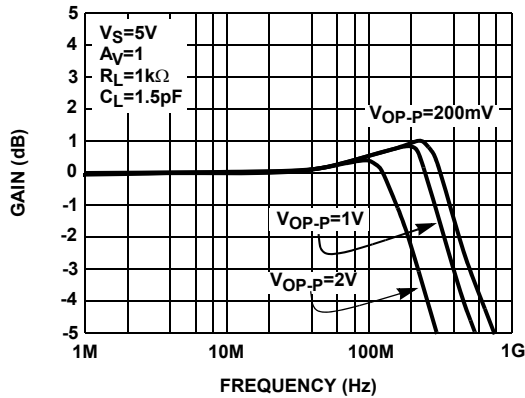

FIGURE 1. FREQUENCY RESPONSE FOR VARIOUS OUTPUT VOLTAGE LEVELS

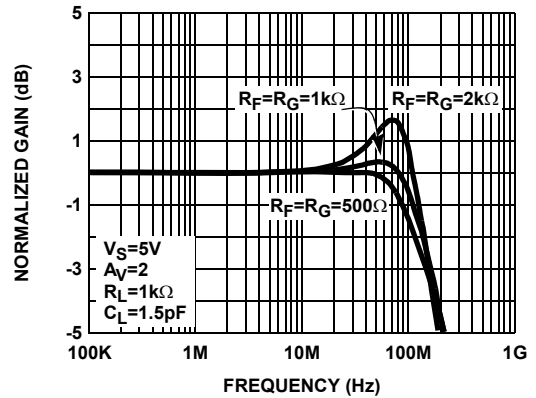

FIGURE 2. SMALL SIGNAL FREQUENCY RESPONSE vs R_F AND R_G

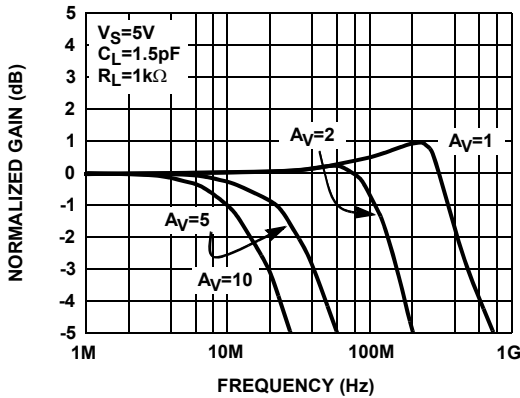

FIGURE 3. SMALL SIGNAL FREQUENCY RESPONSE FOR VARIOUS NON-INVERTING GAINS

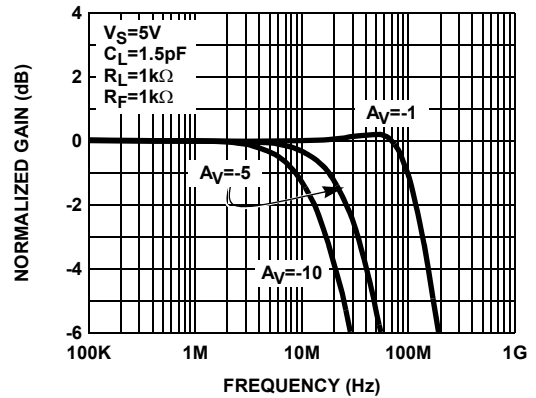

FIGURE 4. SMALL SIGNAL FREQUENCY RESPONSE FOR VARIOUS INVERTING GAINS

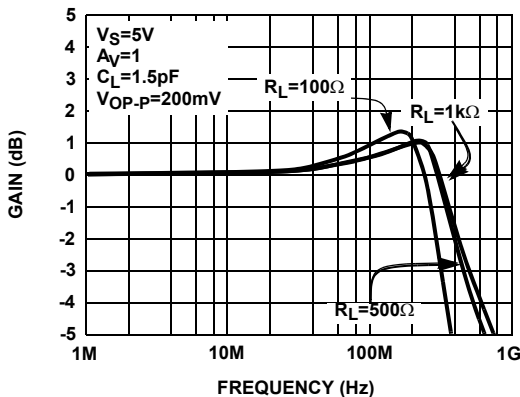

FIGURE 5. SMALL SIGNAL FREQUENCY RESPONSE FOR VARIOUS R_{LOAD}

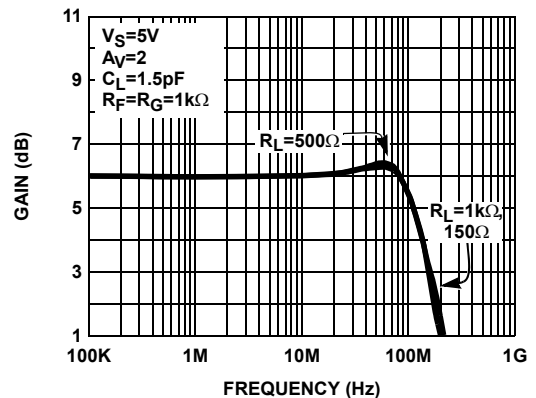

FIGURE 6. SMALL SIGNAL FREQUENCY RESPONSE vs R_{LOAD}

Typical Performance Curves (Continued)

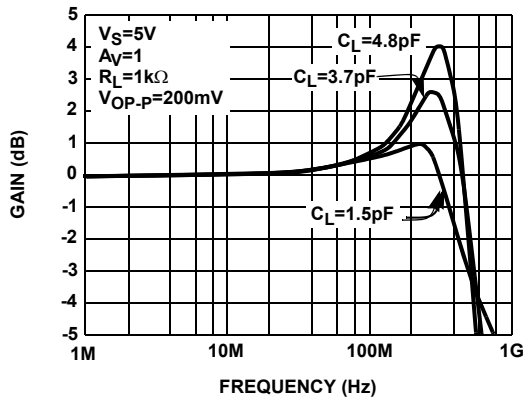

FIGURE 7. SMALL SIGNAL FREQUENCY RESPONSE vs C_L

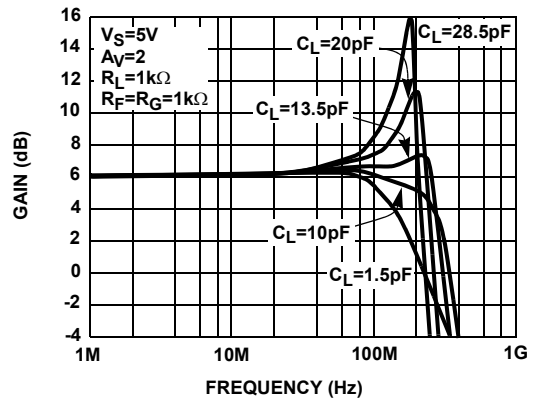

FIGURE 8. SMALL SIGNAL FREQUENCY RESPONSE FOR VARIOUS C_L

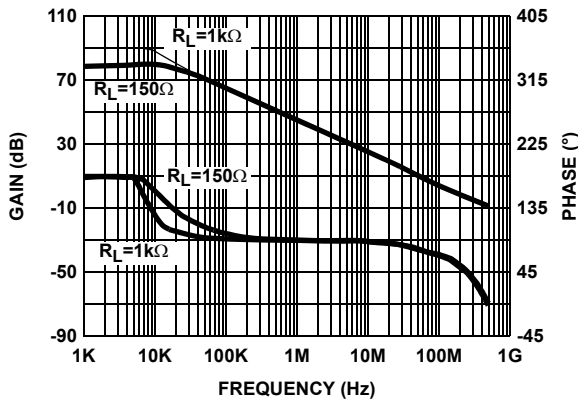

FIGURE 9. OPEN LOOP GAIN AND PHASE vs FREQUENCY

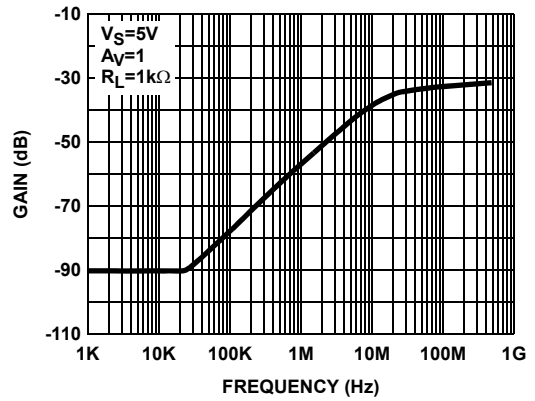

FIGURE 10. DISABLED OUTPUT ISOLATION FREQUENCY RESPONSE

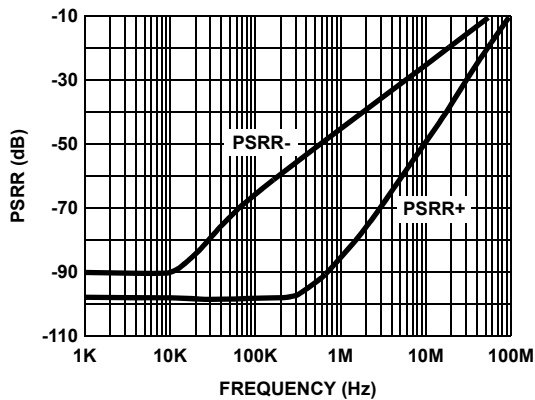

FIGURE 11. POWER SUPPLY REJECTION RATIO vs FREQUENCY

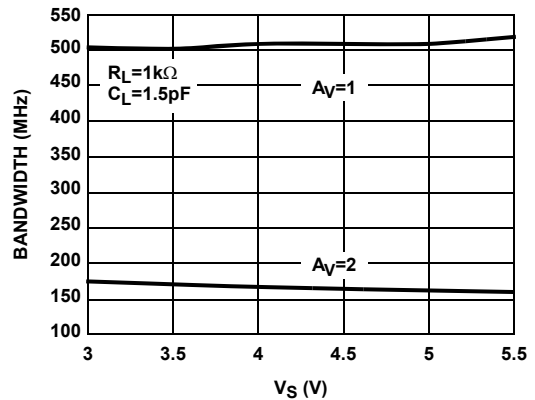

FIGURE 12. SMALL SIGNAL BANDWIDTH vs SUPPLY VOLTAGE

Typical Performance Curves (Continued)

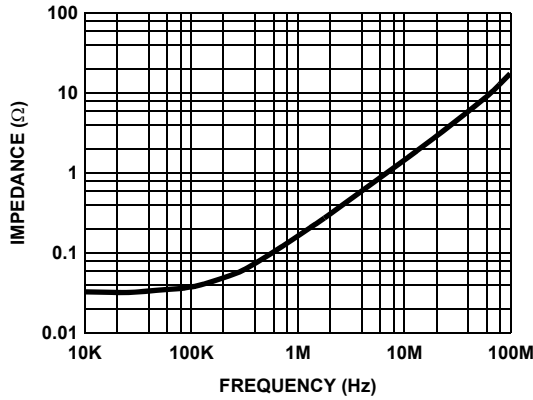

FIGURE 13. OUPUT IMPEDANCE vs FREQUENCY

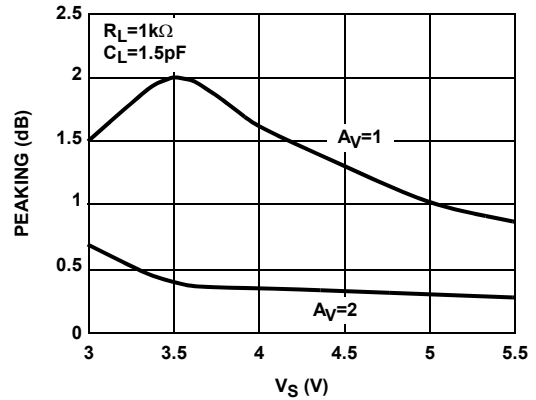

FIGURE 14. SMALL SIGNAL PEAKING vs SUPPLY VOLTAGE

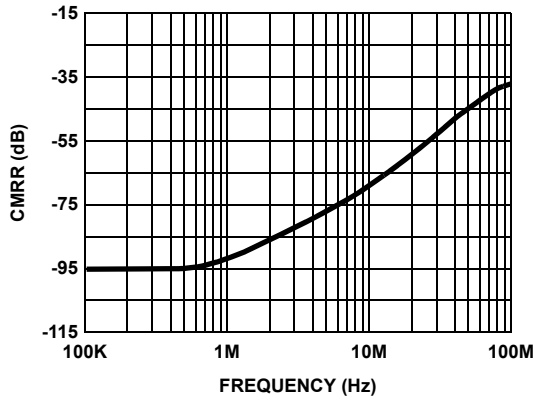

FIGURE 15. COMMON-MODE REJECTION RATIO vs FREQUENCY

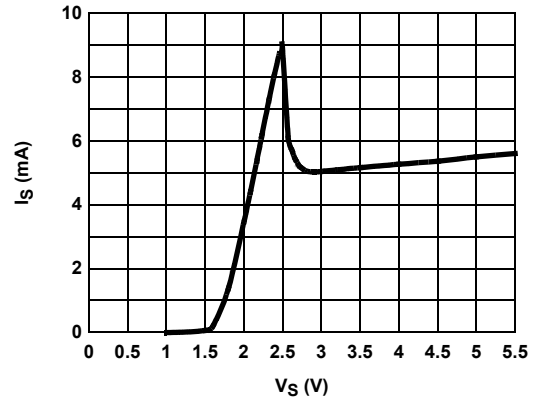

FIGURE 16. SUPPLY CURRENT vs SUPPLY VOLTAGE (PER AMPLIFIER)

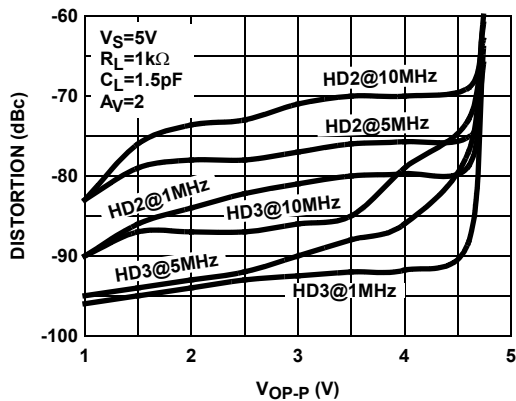

FIGURE 17. HARMONIC DISTORTION vs OUTPUT VOLTAGE

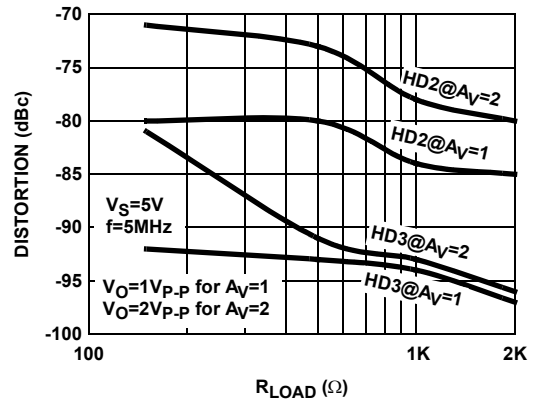

FIGURE 18. HARMONIC DISTORTION vs LOAD RESISTANCE

Typical Performance Curves (Continued)

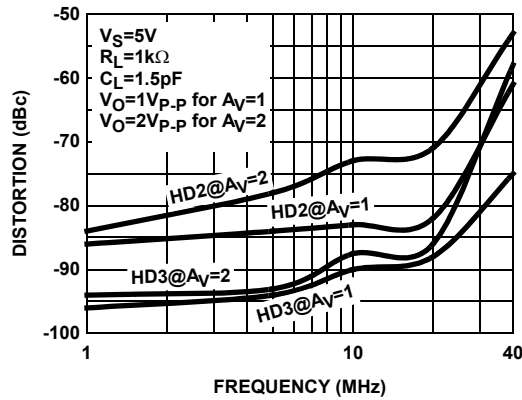

FIGURE 19. HARMONIC DISTORTION vs FREQUENCY

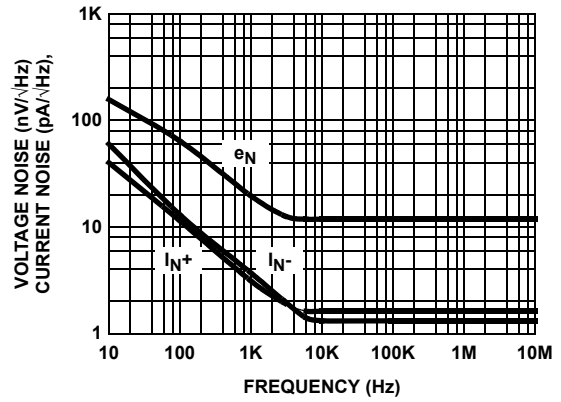

FIGURE 20. VOLTAGE AND CURRENT NOISE vs FREQUENCY

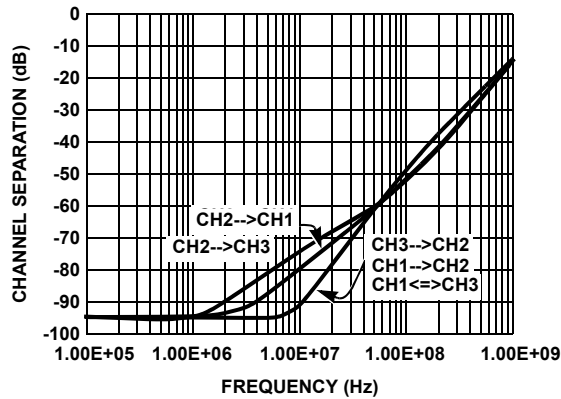

FIGURE 21. CHANNEL SEPARATION vs FREQUENCY

$V_S=5V, A_V=1, R_L=1k\Omega$ TO $2.5V, C_L=1.5pF$

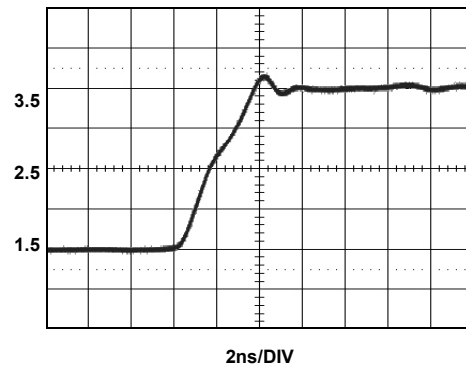

FIGURE 22. LARGE SIGNAL TRANSIENT RESPONSE - RISING

$V_S=5V, A_V=1, R_L=1k\Omega$ TO $2.5V, C_L=1.5pF$

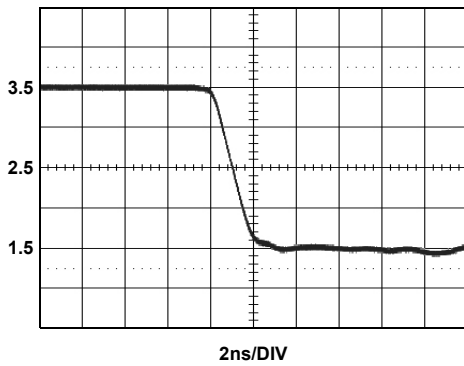

FIGURE 23. LARGE SIGNAL TRANSIENT RESPONSE - FALLING

$V_S=5V, A_V=1, R_L=1k\Omega$ TO $2.5V, C_L=1.5pF$

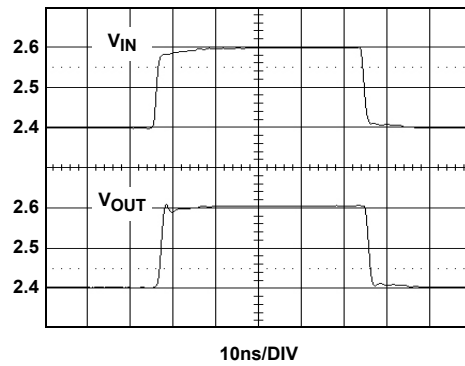

FIGURE 24. SMALL SIGNAL TRANSIENT REPOSE

Typical Performance Curves (Continued)

$V_S=5V, A_V=5, R_L=1k\Omega$ TO 2.5V

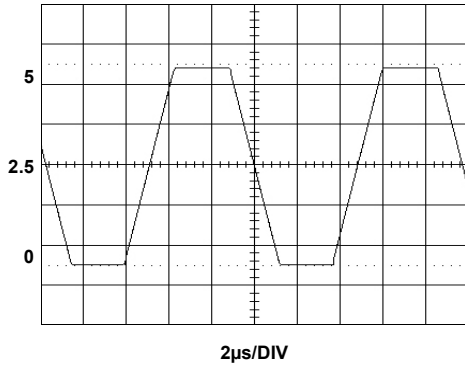

FIGURE 25. OUTPUT SWING

$V_S=5V, A_V=5, R_L=1k\Omega$ TO 2.5V

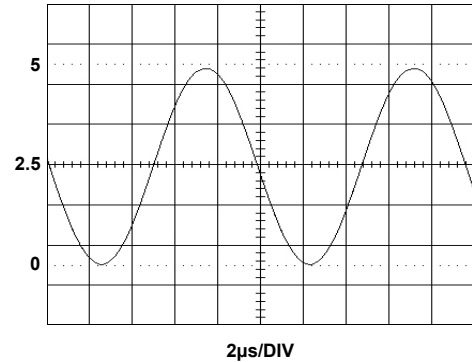

FIGURE 26. OUTPUT SWING

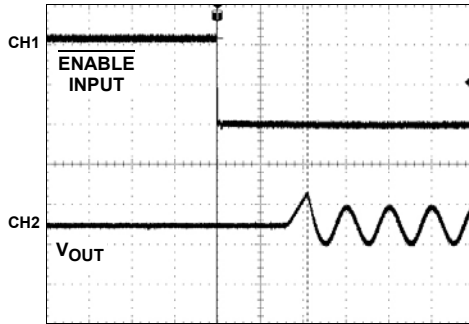

FIGURE 27. ENABLED RESPONSES

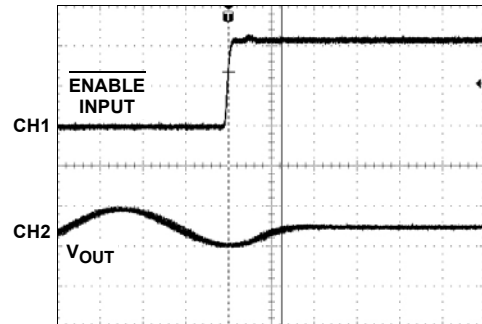

FIGURE 28. DISABLED RESPONSE

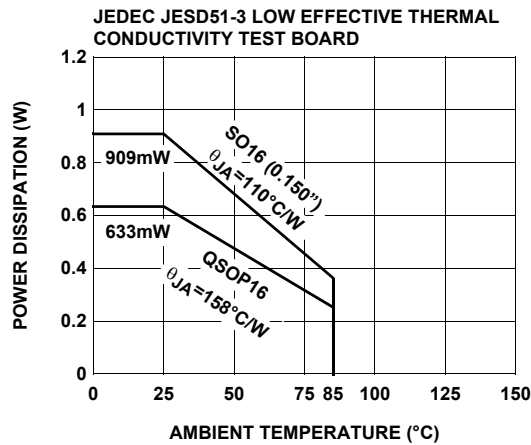

FIGURE 29. PACKAGE POWER DISSIPATION vs AMBIENT TEMPERATURE

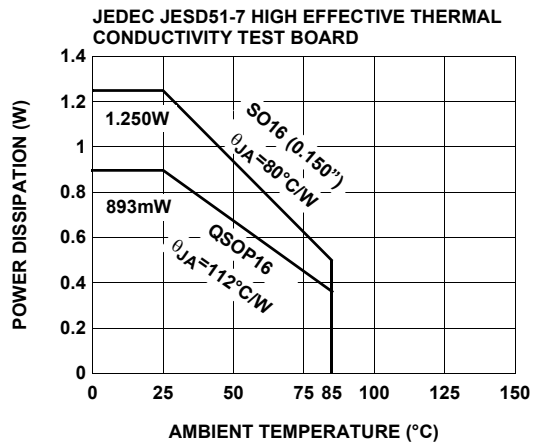
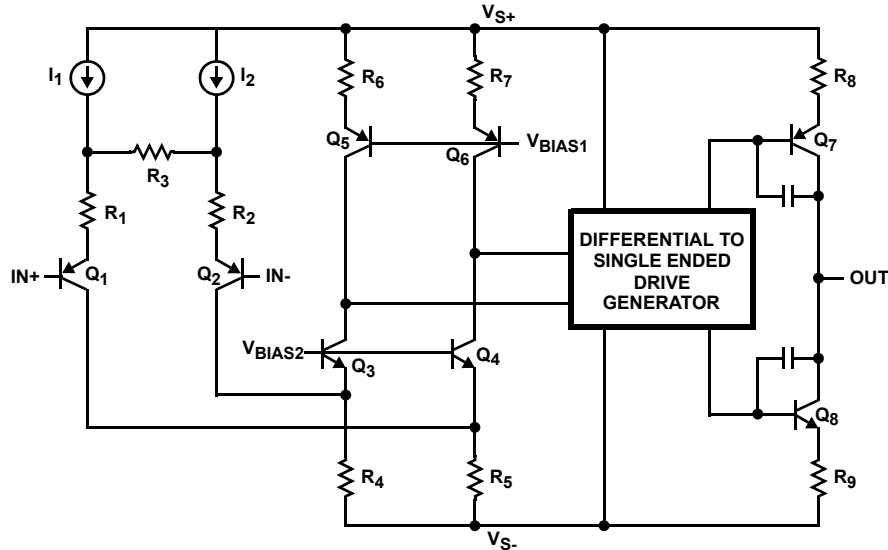

FIGURE 30. PACKAGE POWER DISSIPATION vs AMBIENT TEMPERATURE

Simplified Schematic Diagram



Description of Operation and Application Information

Product Description

The EL8302 is wide bandwidth, single supply, low power and rail-to-rail output voltage feedback operational amplifiers. The amplifiers are internally compensated for closed loop gain of +1 or greater. Connected in voltage follower mode and driving a 1k Ω load, the EL8302 has a -3dB bandwidth of 500MHz. Driving a 150 Ω load, the bandwidth is about 350MHz while maintaining a 600V/us slew rate. The EL8302 is available with a power down pin for each channel to reduce power to 30 μ A typically while the amplifier is disabled.

Input, Output and Supply Voltage Range

The EL8302 has been designed to operate with a single supply voltage from 3V to 5.0V. Split supplies can also be used as long as their total voltage is within 3V to 5.0V. The amplifiers have an input common mode voltage range from 0.15V below the negative supply (V_{S-} pin) to within 1.5V of the positive supply (V_{S+} pin). If the input signal is outside the above specified range, it will cause the output signal to be distorted.

The output of the EL8302 can swing rail to rail. As the load resistance becomes lower, the ability to drive close to each rail is reduced. For the load resistor 1k Ω , the output swing is about 4.9V at a 5V supply. For the load resistor 150 Ω , the output swing is about 4.6V.

Choice of Feedback Resistor and Gain Bandwidth Product

For applications that require a gain of +1, no feedback resistor is required. Just short the output pin to the inverting input pin. For gains greater than +1, the feedback resistor forms a pole with the parasitic capacitance at the inverting input. As this pole becomes smaller, the amplifier's phase margin is reduced. This causes ringing in the time domain and peaking in the

frequency domain. Therefore, R_F has some maximum value that should not be exceeded for optimum performance. If a large value of R_F must be used, a small capacitor in the few pF range in parallel with R_F can help to reduce the ringing and peaking at the expense of reducing the bandwidth.

As far as the output stage of the amplifier is concerned, the output stage is also a gain stage with the load. R_F and R_G appear in parallel with R_L for gains other than +1. As this combination gets smaller, the bandwidth falls off. Consequently, R_F also has a minimum value that should not be exceeded for optimum performance. For gain of +1, $R_F=0$ is optimum. For the gains other than +1, optimum response is obtained with R_F between 300 Ω to 1k Ω .

The EL8302 has a gain bandwidth product of 200MHz. For gains ≥ 5 , its bandwidth can be predicted by the following equation:

$$\text{Gain} \times \text{BW} = 200\text{MHz}$$

Video Performance

For good video performance, an amplifier is required to maintain the same output impedance and the same frequency response as DC levels are changed at the output. This is especially difficult when driving a standard video load of 150 Ω , because the change in output current with DC level. Special circuitry has been incorporated in the EL8302 to reduce the variation of the output impedance with the current output. This results in dG and dP specifications of 0.01% and 0.01 $^\circ$, while driving 150 Ω at a gain of 2. Driving high impedance loads would give a similar or better dG and dP performance.

Driving Capacitive Loads and Cables

The EL8302 can drive 5pF loads in parallel with 1k Ω with less than 5dB of peaking at gain of +1. If less peaking is desired in applications, a small series resistor (usually between 5 Ω to 50 Ω) can be placed in series with the output to eliminate most

peaking. However, this will reduce the gain slightly. If the gain setting is greater than 1, the gain resistor R_G can then be chosen to make up for any gain loss which may be created by the additional series resistor at the output.

When used as a cable driver, double termination is always recommended for reflection-free performance. For those applications, a back-termination series resistor at the amplifier's output will isolate the amplifier from the cable and allow extensive capacitive drive. However, other applications may have high capacitive loads without a back-termination resistor. Again, a small series resistor at the output can help to reduce peaking.

Disable/Power-Down

The EL8302 can be disabled and placed its output in a high impedance state. The turn off time is about 25ns and the turn on time is about 200ns. When disabled, the amplifier's supply current is reduced to 30 μ A typically, thereby effectively eliminating the power consumption. The amplifier's power down can be controlled by standard TTL or CMOS signal levels at the ENABLE pin. The applied logic signal is relative to V_{S-} pin. Letting the ENABLE pin float or applying a signal that is less than 0.8V above V_{S-} will enable the amplifier. The amplifier will be disabled when the signal at ENABLE pin is 2V above V_{S-} .

Output Drive Capability

The EL8302 does not have internal short circuit protection circuitry. They have a typical short circuit current of 80mA sourcing and 150mA sinking for the output is connected to half way between the rails with a 10 Ω resistor. If the output is shorted indefinitely, the power dissipation could easily increase such that the part will be destroyed. Maximum reliability is maintained if the output current never exceeds ± 40 mA. This limit is set by the design of the internal metal interconnections.

Power Dissipation

With the high output drive capability of the EL8302, It is possible to exceed the 125 $^{\circ}$ C absolute maximum junction temperature under certain load current conditions. Therefore, it is important to calculate the maximum junction temperature for the application to determine if the load conditions or package types need to be modified for the amplifier to remain in the safe operating area.

The maximum power dissipation allowed in a package is determined according to:

$$PD_{MAX} = \frac{T_{JMAX} - T_{AMAX}}{\theta_{JA}}$$

Where:

T_{JMAX} = Maximum junction temperature

T_{AMAX} = Maximum ambient temperature

θ_{JA} = Thermal resistance of the package

The maximum power dissipation actually produced by an IC is the total quiescent supply current times the total power supply voltage, plus the power in the IC due to the load, or:

For sourcing:

$$PD_{MAX} = V_S \times I_{SMAX} + \sum_{i=1}^3 (V_S - V_{OUTi}) \times \frac{V_{OUTi}}{R_{Li}}$$

For sinking:

$$PD_{MAX} = V_S \times I_{SMAX} + \sum_{i=1}^3 (V_{OUTi} - V_{S-}) \times I_{LOADi}$$

Where:

V_S = Total supply voltage

I_{SMAX} = Maximum quiescent supply current

V_{OUTi} = Maximum output voltage of the application for each channel

R_{LOADi} = Load resistance tied to ground for each channel

I_{LOADi} = Load current for eachh channel

By setting the two PD_{MAX} equations equal to each other, we can solve the output current and R_{LOAD} to avoid the device overheat.

Power Supply Bypassing and Printed Circuit Board Layout

As with any high frequency device, a good printed circuit board layout is necessary for optimum performance. Lead lengths should be as short as possible. The power supply pin must be well bypassed to reduce the risk of oscillation. For normal single supply operation, where the V_{S-} pin is connected to the ground plane, a single 4.7 μ F tantalum capacitor in parallel with a 0.1 μ F ceramic capacitor from V_{S+} to GND will suffice. This same capacitor combination should be placed at each supply pin to ground if split supplies are to be used. In this case, the V_{S-} pin becomes the negative supply rail.

For good AC performance, parasitic capacitance should be kept to a minimum. Use of wire wound resistors should be avoided because of their additional series inductance. Use of sockets should also be avoided if possible. Sockets add parasitic inductance and capacitance that can result in compromised performance. Minimizing parasitic capacitance at the amplifier's inverting input pin is very important. The feedback resistor should be placed very close to the inverting input pin. Strip line design techniques are recommended for the signal traces.

Typical Applications

VIDEO SYNC PULSE REMOVER

Many CMOS analog to digital converters have a parasitic latch up problem when subjected to negative input voltage levels. Since the sync tip contains no useful video information and it is

a negative going pulse, we can chop it off. Figure 31 shows a gain of 2 connections for EL8302. Figure 32 shows the complete input video signal applied at the input, as well as the output signal with the negative going sync pulse removed.

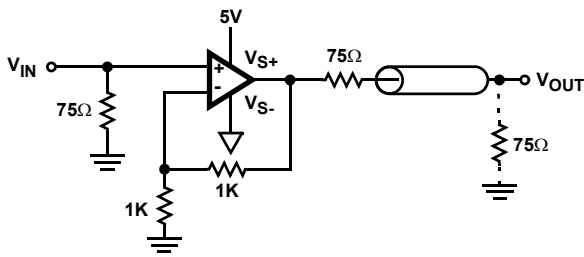

FIGURE 31. SYNC PULSE REMOVER

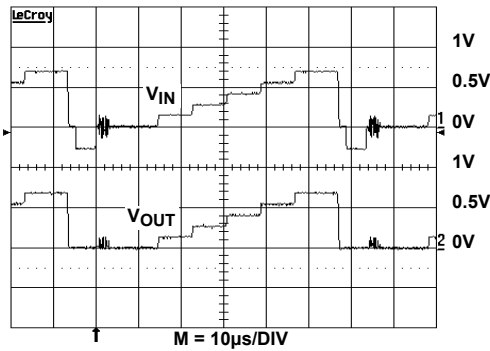

FIGURE 32. VIDEO SIGNAL

MULTIPLEXER

Besides the normal power down usage, the ENABLE pin of the EL8302 can be used for multiplexing applications. Figure 33 shows two channels with the outputs tied together, driving a back terminated 75Ω video load. A 2V_{P-P} 2MHz sine wave is applied to Amp A and a 1V_{P-P} 2MHz sine wave is applied to Amp B. Figure 34 shows the ENABLE signal and the resulting output waveform at V_{OUT}. Observe the break-before-make operation of the multiplexing. Amp A is on and V_{IN1} is passed through to the output when the ENABLE signal is low and turns off in about 25ns when the ENABLE signal is high. About 200ns later, Amp B turns on and V_{IN2} is passed through to the output. The break-before-make operation ensures that more than one amplifier isn't trying to drive the bus at the same time.

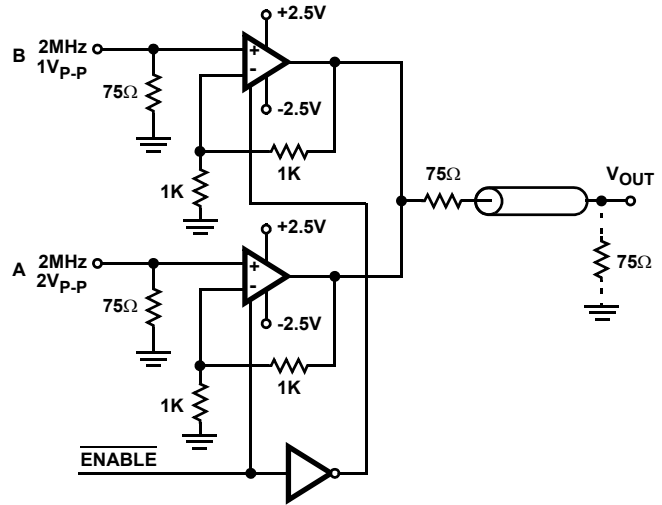

FIGURE 33. TWO TO ONE MULTIPLEXER

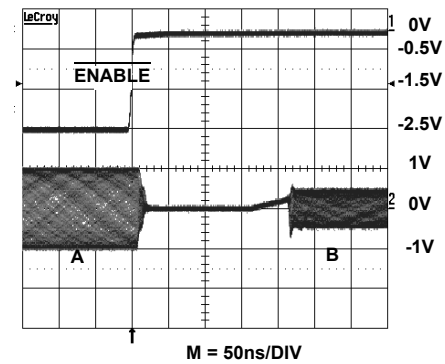

FIGURE 34.

SINGLE SUPPLY VIDEO LINE DRIVER

The EL8302 is wideband rail-to-rail output op amplifiers with large output current, excellent dG, dP, and low distortion that allow them to drive video signals in low supply applications. Figure 35 is the single supply non-inverting video line driver configuration and Figure 36 is the inverting video line driver configuration. The signal is AC coupled by C₁. R₁ and R₂ are used to level shift the input and output to provide the largest output swing. R_F and R_G set the AC gain. C₂ isolates the virtual ground potential. R_T and R₃ are the termination resistors for the line. C₁, C₂ and C₃ are selected big enough to minimize the droop of the luminance signal.

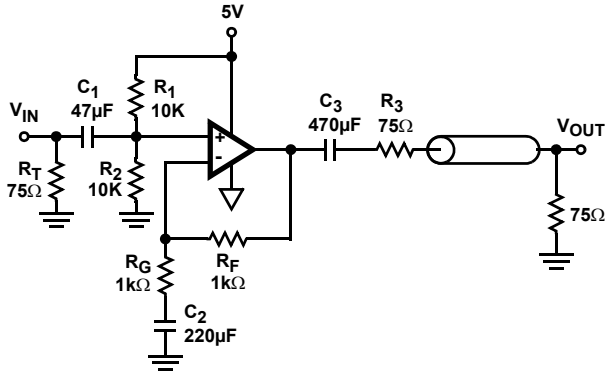

FIGURE 35. 5V SINGLE SUPPLY NON INVERTING VIDEO LINE DRIVER

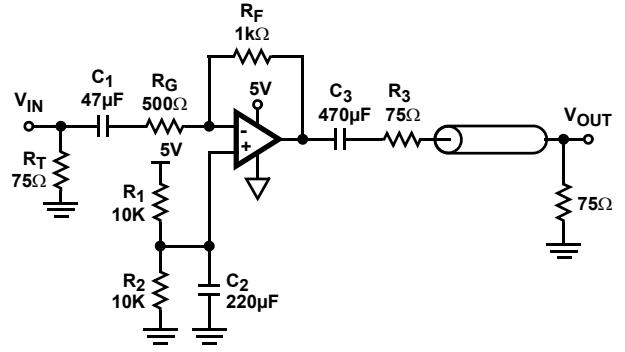

FIGURE 36. SINGLE SUPPLY INVERTING VIDEO LINE DRIVER

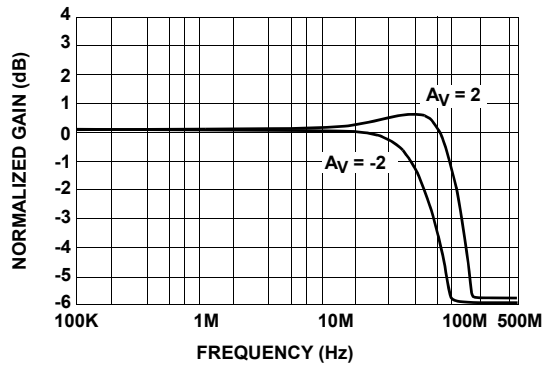
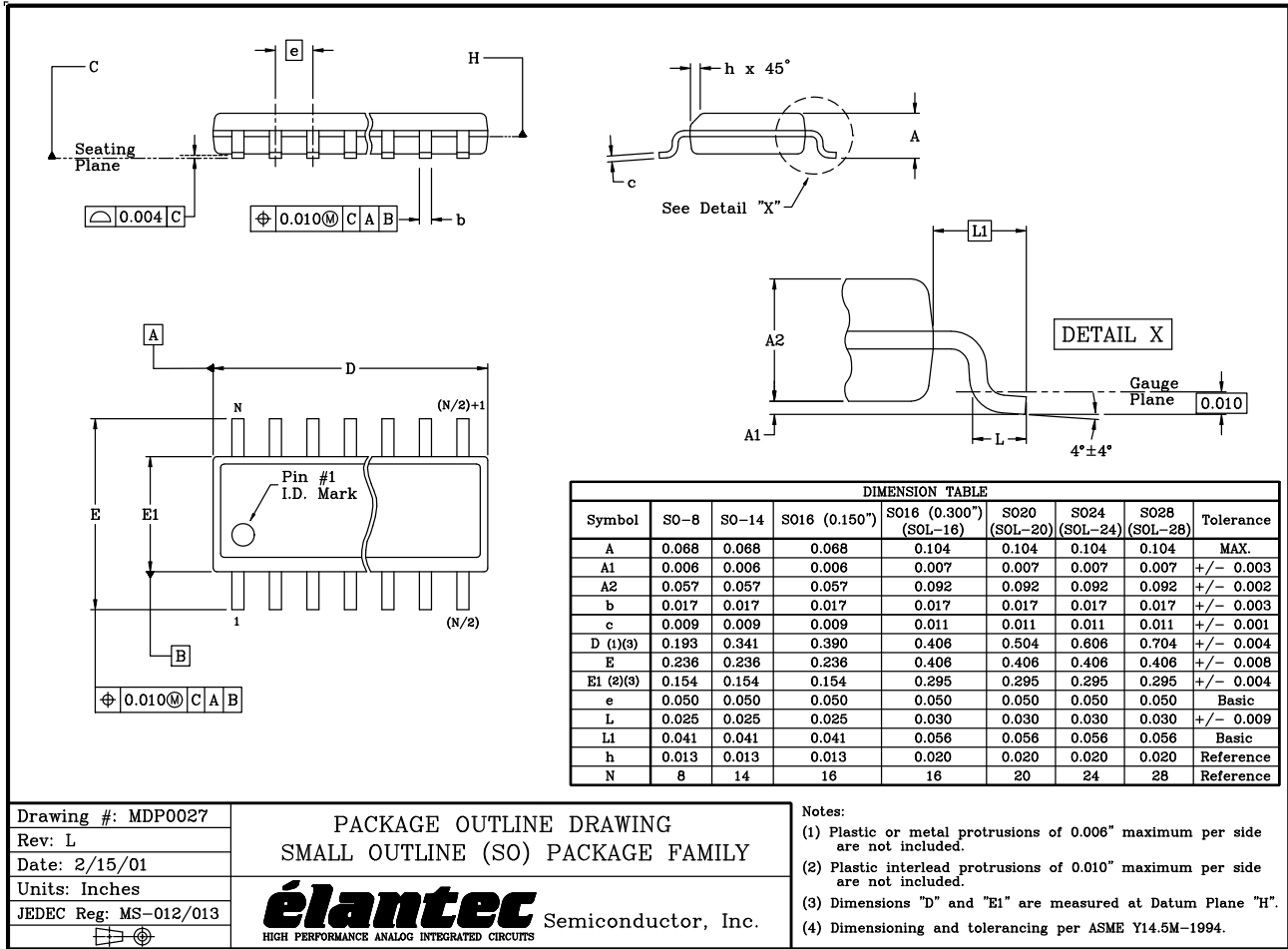

FIGURE 37. VIDEO LINE DRIVER FREQUENCY RESPONSE

SO Package Outline Drawing



Drawing #: MDP0027
 Rev: L
 Date: 2/15/01
 Units: Inches
 JEDEC Reg: MS-012/013

PACKAGE OUTLINE DRAWING
 SMALL OUTLINE (SO) PACKAGE FAMILY

élantec Semiconductor, Inc.
 HIGH PERFORMANCE ANALOG INTEGRATED CIRCUITS

Notes:
 (1) Plastic or metal protrusions of 0.006" maximum per side are not included.
 (2) Plastic interlead protrusions of 0.010" maximum per side are not included.
 (3) Dimensions "D" and "E1" are measured at Datum Plane "H".
 (4) Dimensioning and tolerancing per ASME Y14.5M-1994.

QSOP Package Outline Drawing

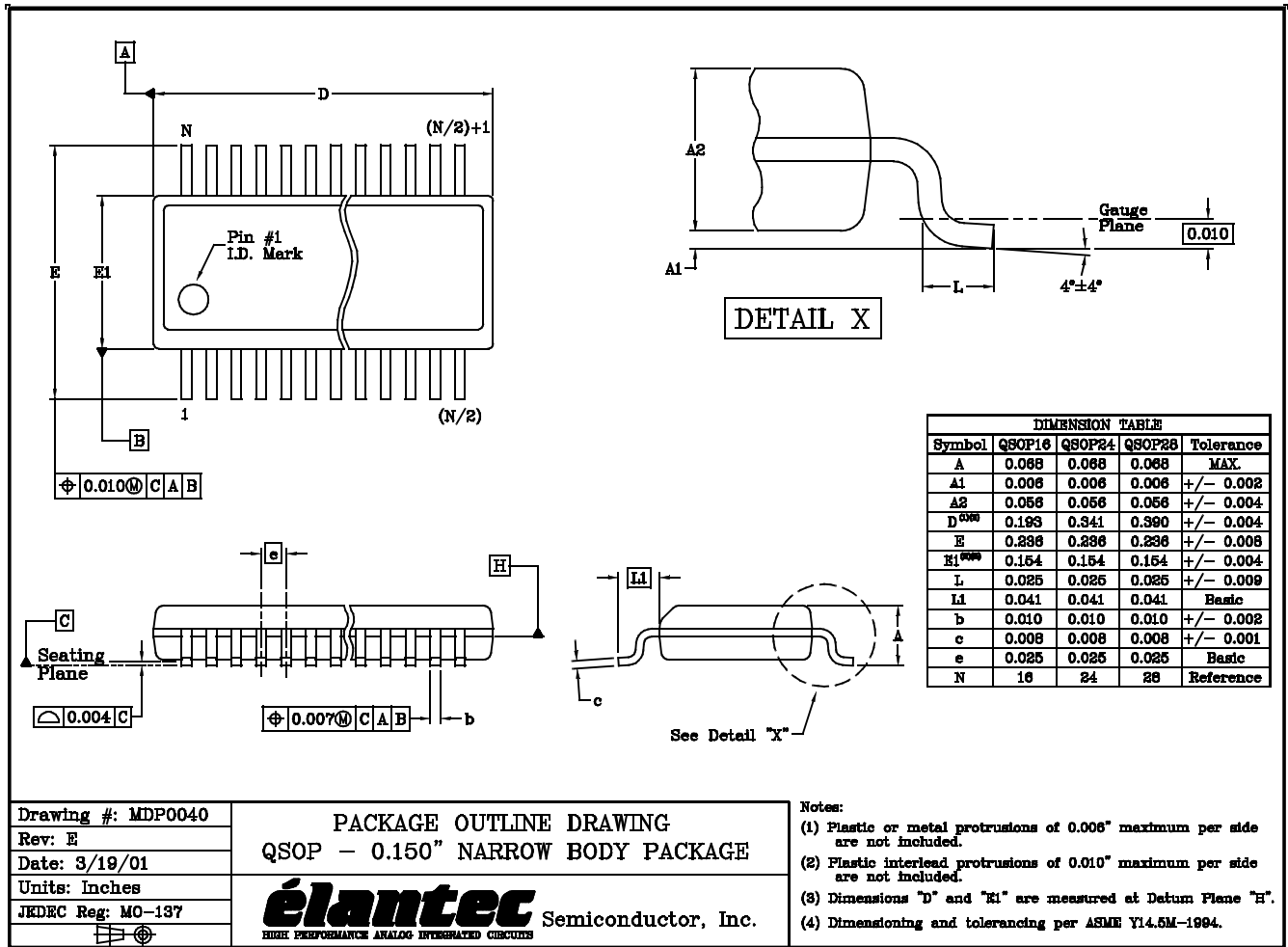

NOTE: The package drawing shown here may not be the latest version. To check the latest revision, please refer to the Intersil website at <http://www.intersil.com/design/packages/index.asp>

© Copyright Intersil Americas LLC 2003-2005. All Rights Reserved.
 All trademarks and registered trademarks are the property of their respective owners.

For additional products, see www.intersil.com/en/products.html

Intersil products are manufactured, assembled and tested utilizing ISO9001 quality systems as noted in the quality certifications found at www.intersil.com/en/support/qualandreliability.html

Intersil products are sold by description only. Intersil may modify the circuit design and/or specifications of products at any time without notice, provided that such modification does not, in Intersil's sole judgment, affect the form, fit or function of the product. Accordingly, the reader is cautioned to verify that datasheets are current before placing orders. Information furnished by Intersil is believed to be accurate and reliable. However, no responsibility is assumed by Intersil or its subsidiaries for its use; nor for any infringements of patents or other rights of third parties which may result from its use. No license is granted by implication or otherwise under any patent or patent rights of Intersil or its subsidiaries.

For information regarding Intersil Corporation and its products, see www.intersil.com

Компания «Океан Электроники» предлагает заключение долгосрочных отношений при поставках импортных электронных компонентов на взаимовыгодных условиях!

Наши преимущества:

- Поставка оригинальных импортных электронных компонентов напрямую с производств Америки, Европы и Азии, а так же с крупнейших складов мира;
- Широкая линейка поставок активных и пассивных импортных электронных компонентов (более 30 млн. наименований);
- Поставка сложных, дефицитных, либо снятых с производства позиций;
- Оперативные сроки поставки под заказ (от 5 рабочих дней);
- Экспресс доставка в любую точку России;
- Помощь Конструкторского Отдела и консультации квалифицированных инженеров;
- Техническая поддержка проекта, помощь в подборе аналогов, поставка прототипов;
- Поставка электронных компонентов под контролем ВП;
- Система менеджмента качества сертифицирована по Международному стандарту ISO 9001;
- При необходимости вся продукция военного и аэрокосмического назначения проходит испытания и сертификацию в лаборатории (по согласованию с заказчиком);
- Поставка специализированных компонентов военного и аэрокосмического уровня качества (Xilinx, Altera, Analog Devices, Intersil, Interpoint, Microsemi, Actel, Aeroflex, Peregrine, VPT, Syfer, Eurofarad, Texas Instruments, MS Kennedy, Miteq, Cobham, E2V, MA-COM, Hittite, Mini-Circuits, General Dynamics и др.);

Компания «Океан Электроники» является официальным дистрибьютором и эксклюзивным представителем в России одного из крупнейших производителей разъемов военного и аэрокосмического назначения «JONHON», а так же официальным дистрибьютором и эксклюзивным представителем в России производителя высокотехнологичных и надежных решений для передачи СВЧ сигналов «FORSTAR».



JONHON

«JONHON» (основан в 1970 г.)

Разъемы специального, военного и аэрокосмического назначения:

(Применяются в военной, авиационной, аэрокосмической, морской, железнодорожной, горно- и нефтедобывающей отраслях промышленности)

«FORSTAR» (основан в 1998 г.)

ВЧ соединители, коаксиальные кабели, кабельные сборки и микроволновые компоненты:

(Применяются в телекоммуникациях гражданского и специального назначения, в средствах связи, РЛС, а так же военной, авиационной и аэрокосмической отраслях промышленности).



Телефон: 8 (812) 309-75-97 (многоканальный)

Факс: 8 (812) 320-03-32

Электронная почта: ocean@oceanchips.ru

Web: <http://oceanchips.ru/>

Адрес: 198099, г. Санкт-Петербург, ул. Калинина, д. 2, корп. 4, лит. А