

# FP1 1 10V

## High frequency, high current power inductors



### Description

- Vertical design utilizes less board space
- Controlled DCR for sensing circuits
- Inductance Range from 195 nH to 320nH
- Current range from 42 to 70 amps
- 10.7 x 7.5mm and 10.5 x 6.2mm footprint surface mount package in a 9.5mm height
- Ferrite core material
- Halogen free, lead free, RoHS compliant

### Applications

- Servers
- Multi-phase and Vcore regulators
- Voltage Regulator Modules (VRMs)
- Desktop VRMs and EVRDs
- Data networking and storage systems
- Point-of-Load modules
- DCR Sensing circuits

### Environmental Data

- Storage temperature range (Component): -40°C to +125°C
- Operating temperature range: -40°C to +125°C (ambient + self-temperature rise)
- Solder reflow temperature: J-STD-020D compliant



**Product specifications**

Part Number <sup>7</sup>	OCL <sup>1</sup> (nH) ±10%	FLL <sup>2</sup> minimum (nH)	I <sub>rms</sub> <sup>3</sup> (amps)	I <sub>sat1</sub> <sup>4</sup> (amps)	I <sub>sat2</sub> <sup>5</sup> (amps)	DCR (mΩ) ±5% @ +20°C	K-factor <sup>6</sup>
<b>V1-10.7 x 7.5 x 9.5mm</b>							
FP1110V1-R20-R	195	140	61	70	58	0.23	278
FP1110V1-R22-R	220	158	61	64	51	0.23	278
FP1110V1-R27-R	270	173	61	55	44	0.23	278
FP1110V1-R32-R	320	230	61	42	34	0.23	278
<b>V2-10.5 x 6.2 x 9.5mm</b>							
FP1110V2-R200-R	200	144	61	65	52	0.18	328

- Open Circuit Inductance (OCL) Test Parameters: 100kHz, 0.1Vrms, 0.0Aac, +25°C
- Full Load Inductance (FLL) Test Parameters: 100kHz, 0.1Vrms, @ I<sub>sat1</sub>, @ +25°C
- I<sub>lim</sub>: DC current for an approximate temperature rise of 40°C without core loss. Derating is necessary for AC currents. PCB layout, trace thickness and width, air-flow, and proximity of other heat generating components will affect the temperature rise. It is recommended that the temperature of the part not exceed +125°C under worst case operating conditions verified in the end application.
- I<sub>sat1</sub>: Peak current for approximately 20% rolloff @ +25°C

- I<sub>sat</sub>: Peak current for approximately 20% rolloff @ +100°C
- K-factor: Used to determine B<sub>ps</sub> for core loss (see graph). B<sub>ps</sub> = K \* L \* ΔI \* 10<sup>3</sup>.  
B<sub>ps</sub>:(Gauss), K: (K-factor from table), L: (Inductance in nH), ΔI (Peak to peak ripple current in Amps).
- Part Number Definition: FP1110Vx-Rxx(x)-R  
FP1110V = Product code  
x = DCR indicator  
Rxx(x)= Inductance value in uH, R= decimal point  
-R suffix = RoHS compliant

**Dimensions (mm)**

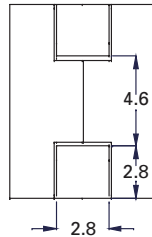
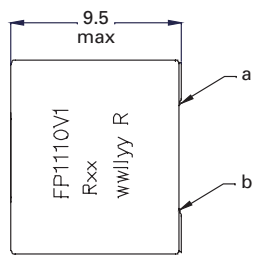
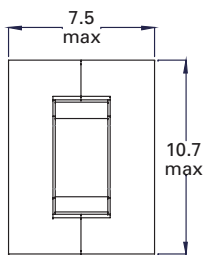

Recommended Pad Layout

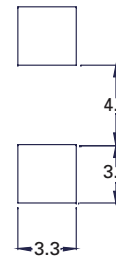

Schematic

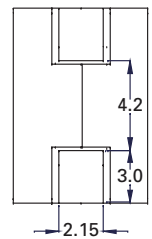
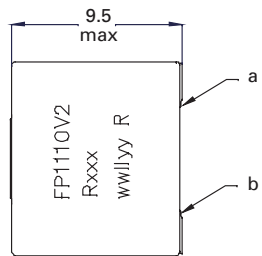
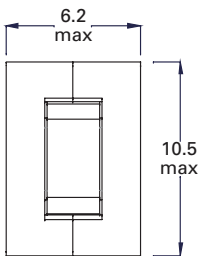
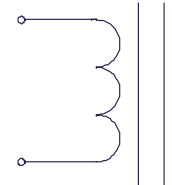

Recommended Pad Layout

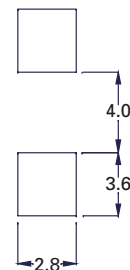

Schematic

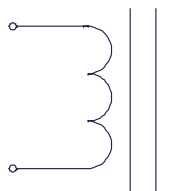

Part marking: FP1110V1 or V2, Rxx(x)=inductance value in μH, R=decimal point  
wwllyy= date code, R=revision level  
DCR measured from point "a" to point "b"  
Soldering surfaces to be coplanar within 0.10 millimeters  
Do not route traces or vias underneath the inductor.

**Packaging information (mm)**

(Drawing not to scale)

(Supplied in tape and reel packaging, 300 parts per 13" diameter reel)

**FP1110V1**

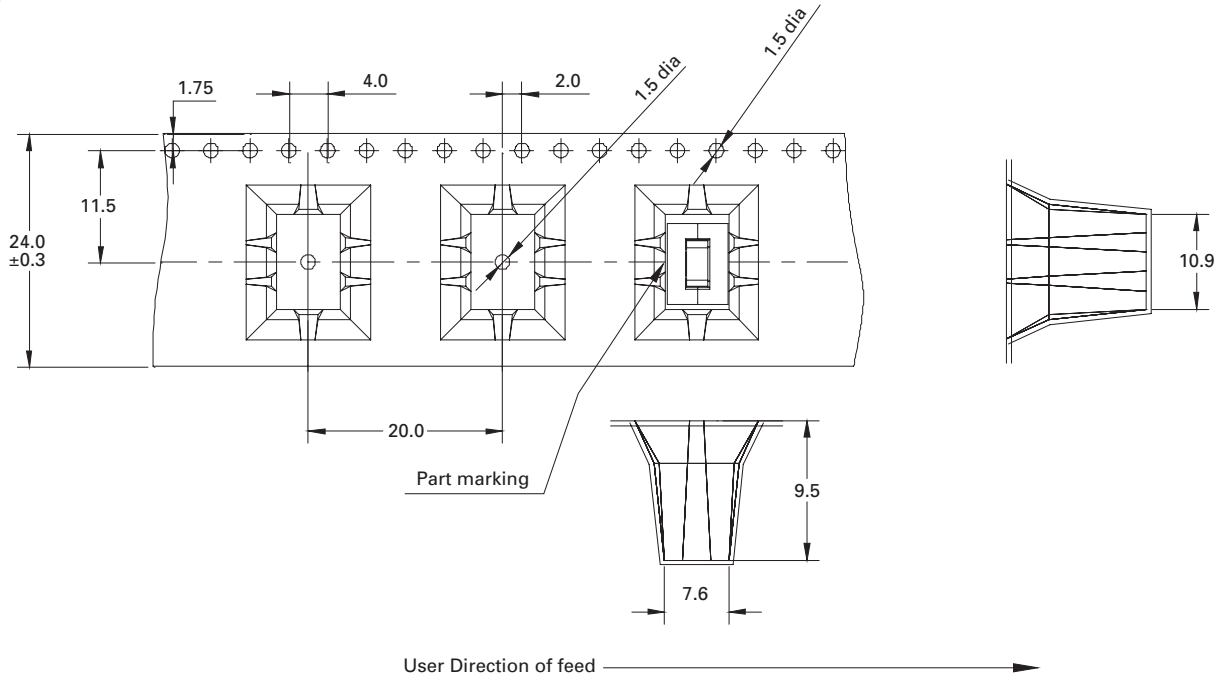

**FP1110V2**

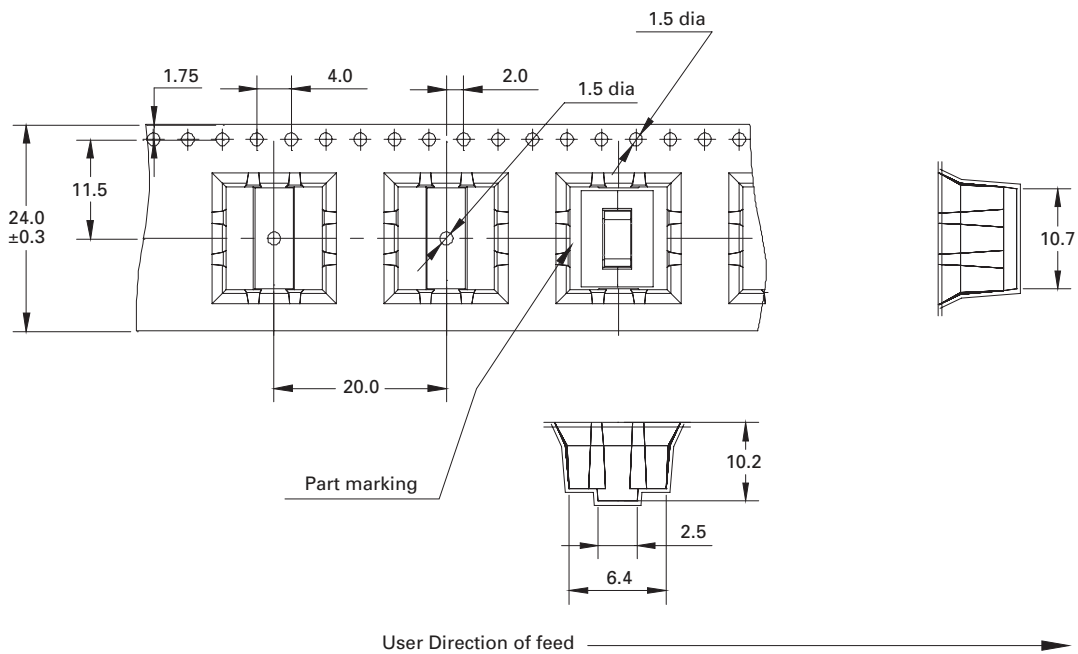

Temperature rise vs. total loss

FP1110V1

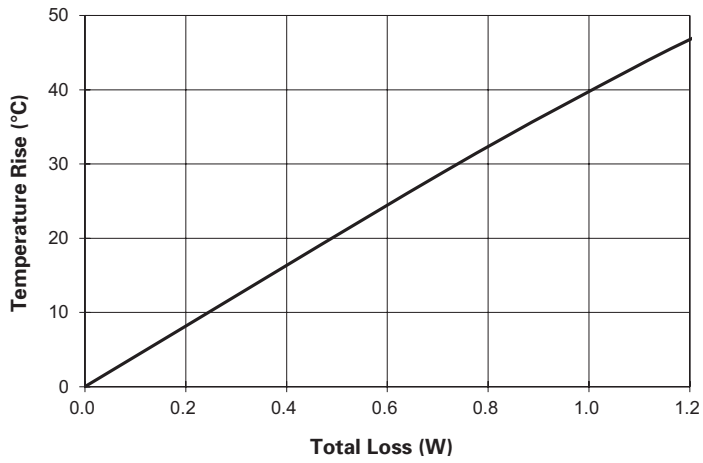

FP1110V2

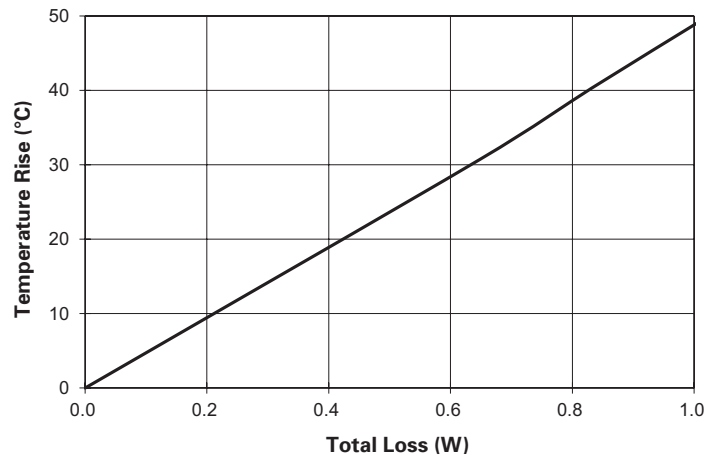

Core loss vs.  $B_{p-p}$

FP1110V1

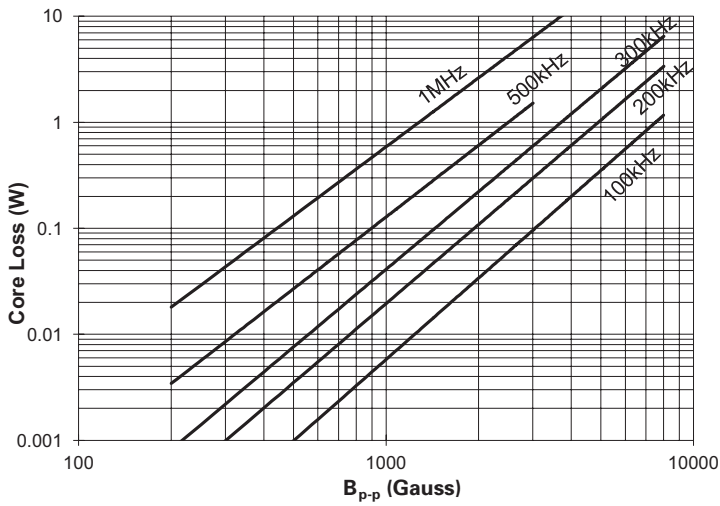

FP1110V2

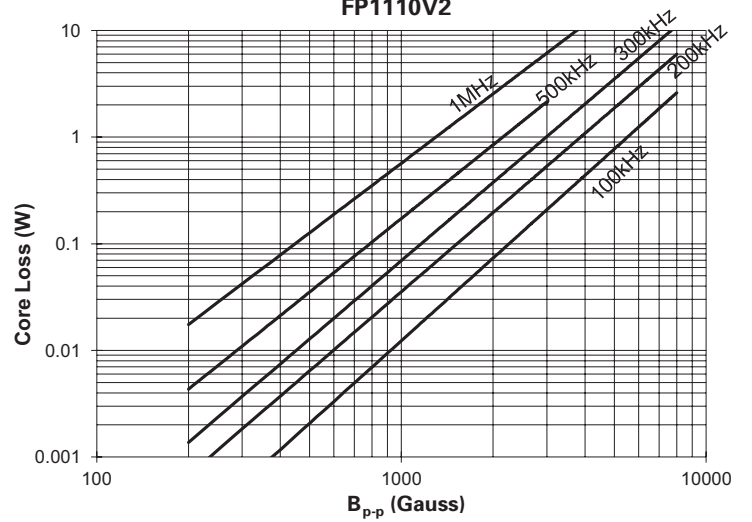

Inductance characteristics

FP1110V1-R20-R

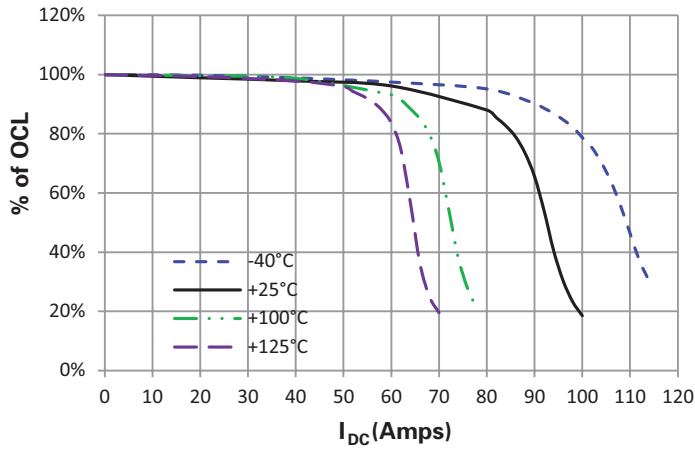

FP1110V1-R22-R

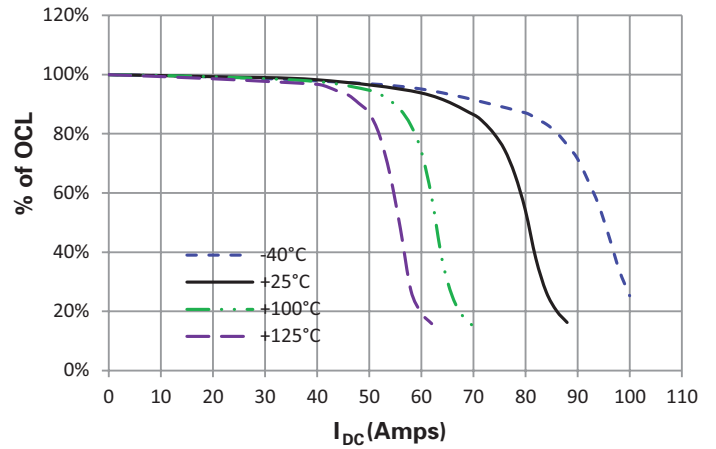

FP1110V1-R27-R

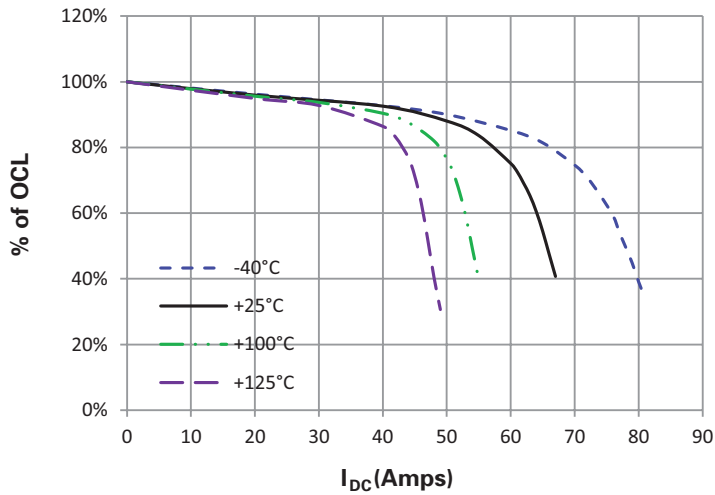

FP1110V1-R32-R

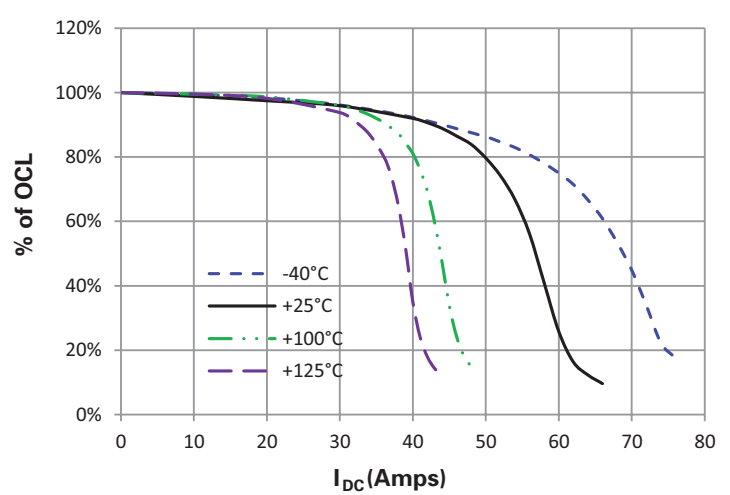

FP1110V2-R200-R

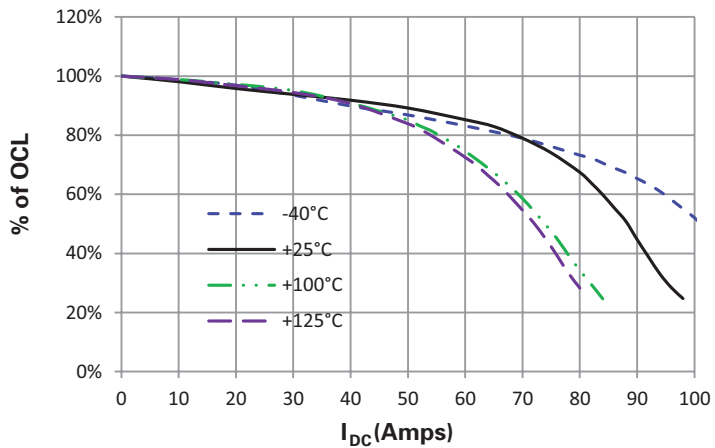

**Solder reflow profile**

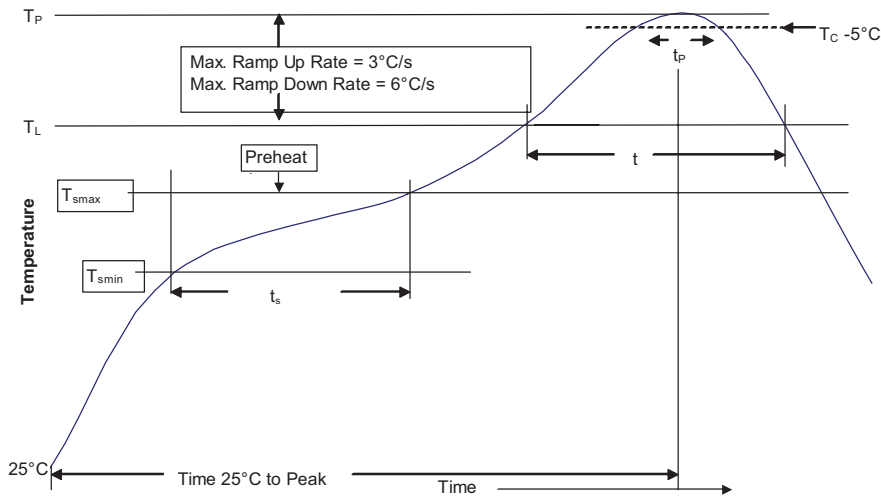

**Table 1 - Standard SnPb Solder ( $T_C$ )**

Package Thickness	Volume $\text{mm}^3$ <350	Volume $\text{mm}^3$ $\geq$ 350
<2.5mm)	235°C	220°C
$\geq$ 2.5mm	220°C	220°C

**Table 2 - Lead (Pb) Free Solder ( $T_C$ )**

Package Thickness	Volume $\text{mm}^3$ <350	Volume $\text{mm}^3$ 350 - 2000	Volume $\text{mm}^3$ >2000
<1.6mm	260°C	260°C	260°C
1.6 - 2.5mm	260°C	250°C	245°C
>2.5mm	250°C	245°C	245°C

**Reference JDEC J-STD-020D**

Profile Feature	Standard SnPb Solder	Lead (Pb) Free Solder
Preheat and Soak		
• Temperature min. ( $T_{smin}$ )	100°C	150°C
• Temperature max. ( $T_{smax}$ )	150°C	200°C
• Time ( $T_{smin}$ to $T_{smax}$ ) ( $t_s$ )	60-120 Seconds	60-120 Seconds
Average ramp up rate $T_{smax}$ to $T_p$	3°C/ Second Max.	3°C/ Second Max.
Liquidous temperature ( $T_L$ )	183°C	217°C
Time at liquidous ( $t_L$ )	60-150 Seconds	60-150 Seconds
Peak package body temperature ( $T_p$ )*	Table 1	Table 2
Time ( $t_p$ )** within 5 °C of the specified classification temperature ( $T_C$ )	20 Seconds**	30 Seconds**
Average ramp-down rate ( $T_p$ to $T_{smax}$ )	6°C/ Second Max.	6°C/ Second Max.
Time 25°C to Peak Temperature	6 Minutes Max.	8 Minutes Max.

\* Tolerance for peak profile temperature ( $T_p$ ) is defined as a supplier minimum and a user maximum.

\*\* Tolerance for time at peak profile temperature ( $t_p$ ) is defined as a supplier minimum and a user maximum.

Life Support Policy: Eaton does not authorize the use of any of its products for use in life support devices or systems without the express written approval of an officer of the Company. Life support systems are devices which support or sustain life, and whose failure to perform, when properly used in accordance with instructions for use provided in the labeling, can be reasonably expected to result in significant injury to the user.

Eaton reserves the right, without notice, to change design or construction of any products and to discontinue or limit distribution of any products. Eaton also reserves the right to change or update, without notice, any technical information contained in this bulletin.

**Eaton**  
Electronics Division  
1000 Eaton Boulevard  
Cleveland, OH 44122  
United States  
www.eaton.com/elx

© 2015 Eaton  
All Rights Reserved  
Printed in USA  
Publication No. 10427 BU-MC15008  
August 2015

Eaton is a registered trademark.

All other trademarks are property of their respective owners.

Компания «Океан Электроники» предлагает заключение долгосрочных отношений при поставках импортных электронных компонентов на взаимовыгодных условиях!

Наши преимущества:

- Поставка оригинальных импортных электронных компонентов напрямую с производств Америки, Европы и Азии, а так же с крупнейших складов мира;
- Широкая линейка поставок активных и пассивных импортных электронных компонентов (более 30 млн. наименований);
- Поставка сложных, дефицитных, либо снятых с производства позиций;
- Оперативные сроки поставки под заказ (от 5 рабочих дней);
- Экспресс доставка в любую точку России;
- Помощь Конструкторского Отдела и консультации квалифицированных инженеров;
- Техническая поддержка проекта, помощь в подборе аналогов, поставка прототипов;
- Поставка электронных компонентов под контролем ВП;
- Система менеджмента качества сертифицирована по Международному стандарту ISO 9001;
- При необходимости вся продукция военного и аэрокосмического назначения проходит испытания и сертификацию в лаборатории (по согласованию с заказчиком);
- Поставка специализированных компонентов военного и аэрокосмического уровня качества (Xilinx, Altera, Analog Devices, Intersil, Interpoint, Microsemi, Actel, Aeroflex, Peregrine, VPT, Syfer, Eurofarad, Texas Instruments, MS Kennedy, Miteq, Cobham, E2V, MA-COM, Hittite, Mini-Circuits, General Dynamics и др.);

Компания «Океан Электроники» является официальным дистрибьютором и эксклюзивным представителем в России одного из крупнейших производителей разъемов военного и аэрокосмического назначения «JONHON», а так же официальным дистрибьютором и эксклюзивным представителем в России производителя высокотехнологичных и надежных решений для передачи СВЧ сигналов «FORSTAR».



## JONHON

«JONHON» (основан в 1970 г.)

Разъемы специального, военного и аэрокосмического назначения:

(Применяются в военной, авиационной, аэрокосмической, морской, железнодорожной, горно- и нефтедобывающей отраслях промышленности)

«FORSTAR» (основан в 1998 г.)

ВЧ соединители, коаксиальные кабели, кабельные сборки и микроволновые компоненты:

(Применяются в телекоммуникациях гражданского и специального назначения, в средствах связи, РЛС, а так же военной, авиационной и аэрокосмической отраслях промышленности).



Телефон: 8 (812) 309-75-97 (многоканальный)

Факс: 8 (812) 320-03-32

Электронная почта: [ocean@oceanchips.ru](mailto:ocean@oceanchips.ru)

Web: <http://oceanchips.ru/>

Адрес: 198099, г. Санкт-Петербург, ул. Калинина, д. 2, корп. 4, лит. А