



# Aluminum electrolytic capacitors

Axial-lead and soldering star capacitors

**Series/Type:** B41693, B41793

**Date:** November 2008

### Applications

- Excellent reliable design for automotive applications

### Features

- High operating temperature capability up to 150 °C
- Rated voltage up to 75 V DC
- Low ESR
- High reliability
- Outstanding parametric stability
- High ripple current capability
- High vibration resistance
- Long useful life
- Shelf life up to 15 years at storage temperatures up to 40 °C.

To ensure solderability, the capacitors should be built into the application within one year of delivery. After a total of two years' storage, the operating voltage must be applied for one hour to ensure the specified leakage current.

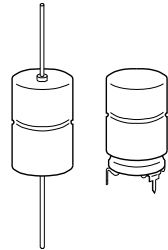

### Construction

- Charge/discharge-proof, polar
- Aluminum case with insulating sleeve
- Negative pole connected to case

### Terminals

- Axial leads, welded to ensure perfect electrical contact
- Also available with soldering stars

### Taping and Packing

- Axial-lead capacitors will be delivered in pallet package. Capacitors with  $d \times l \leq 16 \times 30$  mm are also available taped on reel.
- Soldering star capacitors are packed in cardboard.

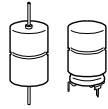
**Specifications and characteristics in brief**

Rated voltage $V_R$	25 ... 75 V DC						
Surge voltage $V_S$	$1.15 \cdot V_R$						
Rated capacitance $C_R$	100 ... 4000 $\mu\text{F}$						
Capacitance tolerance	$-10/+30\% \triangle Q$						
Leakage current $I_{\text{leak}}$ (5 min, 20 °C)	$I_{\text{leak}} \leq 0.006 \mu\text{A} \cdot \left( \frac{C_R}{\mu\text{F}} \cdot \frac{V_R}{\text{V}} \right) + 4 \mu\text{A}$						
Self-inductance ESL <sup>1)</sup>	Diameter d (mm)	12	14	16	18	20/21	
	Terminals	Length l (mm)					Approx. ESL (nH)
	axial	25	–	22	26	–	–
		29	–	–	–	–	38
		30	21	24	29	34	–
		39	–	–	33	38	45
		49	–	–	–	–	50
	soldering star	25	–	6	7	–	–
		30	6	7	8	10	–
39		–	–	9	11	–	
Useful life 150 °C; $V_R$ ; $0.5 \cdot I_{AC,R}$ 125 °C; $V_R$ ; $I_{AC,R}$ 85 °C; $V_R$ ; $I_{AC,max}$ 40 °C; $V_R$ ; $2.1 \cdot I_{AC,R}$	> 1000 h					Requirements:	
	> 5000 h					$\Delta C/C \leq \pm 30\%$ of initial value	
	> 15000 h					ESR $\leq 3$ times initial specified limit	
	> 200000 h					$I_{\text{leak}} \leq$ initial specified limit	
Voltage endurance test 125 °C; $V_R$	2000 h					Post test requirements:	
						$\Delta C/C \leq \pm 10\%$ of initial value	
						ESR $\leq 1.3\%$ of initial specified limit	
Vibration resistance test	To IEC 60068-2-6, test Fc:						
	Displacement amplitude 1.5 mm, at 10 Hz ... 2 kHz, acceleration max. 20 g, duration $3 \times 2$ h. Capacitor mounted by its wire leads at a distance of $(6 \pm 1)$ mm from the case and additionally clamped by the case.						
IEC climatic category	To IEC 60068-1: 55/125/56 (–55 °C/+125 °C/56 days damp heat test)						
Detail specification	Similar to CECC 30301-802						
Sectional specification	IEC 60384-4						

1) If optimum circuit design is used, the values are lower by 30%.

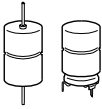

**B41693, B41793**

**Up to 150 °C**

## Axial-lead capacitors

### Dimensional drawing

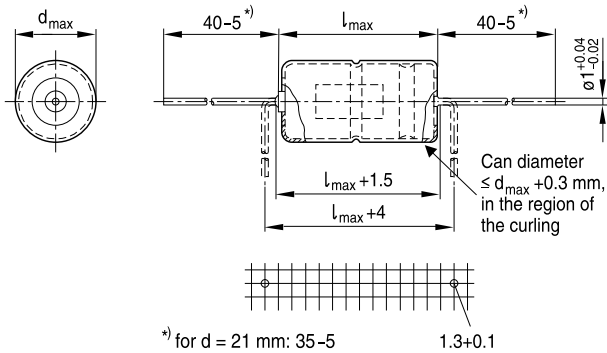

KAL0524-S-E

### Dimensions, weights and packing units

$d \times l$ mm	$d_{max} \times l_{max}$ mm	Approx. weight g	Packing units (pcs.)	
			Pallet	Reel
12 × 30	12.5 × 30.5	5.1	288	450
14 × 25	14.5 × 25.5	5.7	200	350
14 × 30	14.5 × 30.5	6.8	200	350
16 × 30	16.5 × 30.5	8.9	180	250
16 × 39	16.5 × 40	11.7	180	—
18 × 30	18.5 × 30.5	11.1	160	—
18 × 39	18.5 × 40	14.7	160	—
20 × 29	20.5 × 29.5	13.5	140	—
21 × 39	21.5 × 40	20.0	140	—
21 × 49	21.5 × 50	25.0	110	—



## Soldering star capacitors

### Dimensional drawing

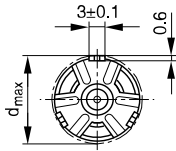

Mounting holes  
d = 12 mm ... 14 mm

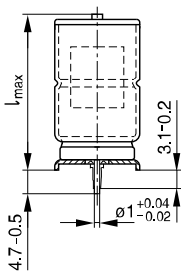
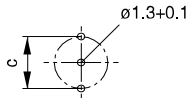

Mounting holes  
d = 16 mm ... 18 mm

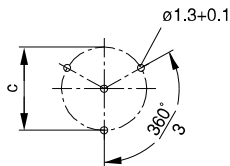

KAL0666-9

### Dimensions, weights and packing units

d × l mm	d <sub>max</sub> × l <sub>max</sub> mm	c ±0.1 mm	Approx. weight g	Packing units pcs.
12 × 30	13.5 × 32	12.5	5.4	480
14 × 25	15.5 × 27	14.5	6.1	480
14 × 30	15.5 × 32	14.5	7.2	480
16 × 30	17.5 × 32	16.5	9.4	300
16 × 39	17.5 × 41.5	16.5	12.2	200
18 × 30	19.5 × 32	18.5	11.8	300
18 × 39	19.5 × 41.5	18.5	15.4	200

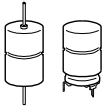

**B41693, B41793**
**Up to 150 °C**
**Overview of available types**

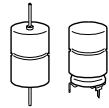
$V_R$ (V DC)	25	40	63	75
	Case dimensions $d \times l$ (mm)			
$C_R$ ( $\mu$ F)				
100			12 × 30	12 × 30
220			14 × 30	16 × 30
330		12 × 30	16 × 30	
470	14 × 25	14 × 30	16 × 39	18 × 39 20 × 29
560			20 × 29	
680		16 × 30	18 × 39	21 × 39
1000	16 × 30	16 × 39 18 × 30	21 × 39	21 × 49
1200		20 × 29	21 × 49	
1500	16 × 39	18 × 39		
1800	20 × 29			
2000	18 × 39			
2200		21 × 39		
2700		21 × 49		
3000	21 × 39			
4000	21 × 49			

**Case dimensions and ordering codes**

$V_R$	$C_R$	Case dimensions $d \times l$ mm	Ordering code Axial pallet	Ordering code Axial reel	Ordering code Soldering star
V DC	$\mu F$				
25	470	14 × 25	B41693A5477Q007	B41693A5477Q009	B41793A5477Q000
	1000	16 × 30	B41693A5108Q007	B41693A5108Q009	B41793A5108Q000
	1500	16 × 39	B41693A5158Q007		B41793A5158Q000
	1800	20 × 29	B41693A5188Q007		
	2000	18 × 39	B41693A5208Q007		B41793A5208Q000
	3000	21 × 39	B41693A5308Q007		
	4000	21 × 49	B41693A5408Q007		
40	330	12 × 30	B41693A7337Q007	B41693A7337Q009	B41793A7337Q000
	470	14 × 30	B41693A7477Q007	B41693A7477Q009	B41793A7477Q000
	680	16 × 30	B41693A7687Q007	B41693A7687Q009	B41793A7687Q000
	1000	16 × 39	B41693B7108Q007		B41793B7108Q000
	1000 ▽	18 × 30	B41693A7108Q007		B41793A7108Q000
	1200	20 × 29	B41693A7128Q007		
	1500	18 × 39	B41693A7158Q007		B41793A7158Q000
	2200	21 × 39	B41693A7228Q007		
	2700	21 × 49	B41693A7278Q007		
	63	100	12 × 30	B41693A8107Q007	B41693A8107Q009
220		14 × 30	B41693A8227Q007	B41693A8227Q009	B41793A8227Q000
330		16 × 30	B41693A8337Q007	B41693A8337Q009	B41793A8337Q000
470		16 × 39	B41693A8477Q007		B41793A8477Q000
560		20 × 29	B41693A8567Q007		
680		18 × 39	B41693A8687Q007		B41793A8687Q000
1000		21 × 39	B41693A8108Q007		
1200		21 × 49	B41693A8128Q007		
75	100	12 × 30	B41693A0107Q007	B41693A0107Q009	B41793A0107Q000
	220	16 × 30	B41693A0227Q007	B41693A0227Q009	B41793A0227Q000
	470	18 × 39	B41693A0477Q007		B41793A0477Q000
	470 ▽	20 × 29	B41693B0477Q007		
	680	21 × 39	B41693A0687Q007		
	1000	21 × 49	B41693A0108Q007		

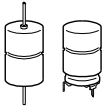
▽ Variant with different case dimensions



**B41693, B41793**

**Up to 150 °C**

**Technical data**

$C_R$	$ESR_{typ}$	$ESR_{max}$	$ESR_{max}$	$ESR_{max}$	$Z_{max}$	$I_{AC,max}$	$I_{AC,max}$	$I_{AC,max}$	$I_{AC,R}$	$I_{AC,max}$
100 Hz	100 Hz	100 Hz	100 Hz	10 kHz	100 kHz	10 kHz	10 kHz	10 kHz	10 kHz	10 kHz
20 °C	20 °C	20 °C	-40 °C	20 °C	20 °C	85 °C	105 °C	125 °C	125 °C	150 °C
$\mu F$	$m\Omega$	$m\Omega$	$m\Omega$	$m\Omega$	$m\Omega$	A	A	A	A	A
<b><math>V_R = 25 V DC</math></b>										
470	160	260	1900	140	102	4.2	3.6	2.8	1.95	1.0
1000	80	130	900	75	55	6.2	5.3	4.2	2.9	1.4
1500	55	85	600	50	39	8.6	7.4	5.8	4.0	2.0
1800	45	70	600	40	30	9.5	8.2	6.4	4.45	2.2
2000	45	70	500	42	26	9.2	7.9	6.2	4.3	4.1
3000	27	43	450	25	21	13.7	11.8	9.2	6.4	3.2
4000	20	33	320	20	16	17.3	14.9	11.7	8.0	4.0
<b><math>V_R = 40 V DC</math></b>										
330	200	320	2500	150	140	4.3	3.7	2.9	2.0	1.0
470	140	220	1700	110	102	5.2	4.5	3.5	2.45	1.2
680	100	160	1200	80	75	6.1	5.2	4.1	2.85	1.4
1000	65	110	700	57	55	8.4	7.2	5.7	3.9	1.9
1000 ▽	70	115	700	65	62	6.6	5.7	4.5	3.1	1.5
1200	52	85	600	45	44	9.3	8.0	6.3	4.35	2.2
1500	48	75	500	45	43	9.2	7.9	6.2	4.3	2.1
2200	30	50	450	26	26	13.6	11.7	9.2	6.3	6.1
2700	24	40	330	21	21	17.1	14.7	11.5	7.9	3.9
<b><math>V_R = 63 V DC</math></b>										
100	430	700	3300	230	215	3.7	3.2	2.5	1.7	0.85
220	200	320	1700	110	102	5.3	4.6	3.6	2.5	1.25
330	130	220	1200	80	75	6.2	5.3	4.2	2.9	1.45
470	90	150	900	55	52	8.5	7.3	5.7	4.0	2.0
560	72	120	630	45	44	9.5	8.1	6.4	4.4	2.2
680	67	110	550	45	44	9.2	7.9	6.2	4.3	2.1
1000	43	70	440	27	27	13.7	11.8	9.2	6.4	3.2
1200	35	58	380	22	22	17.1	14.7	11.5	8.0	4.0
<b><math>V_R = 75 V DC</math></b>										
100	380	600	3000	200	190	4.0	3.5	2.7	1.85	0.9
220	180	300	1500	100	95	6.0	5.1	4.0	2.8	1.4
470	85	140	700	50	48	9.2	7.9	6.2	4.3	2.1
470 ▽	80	135	720	45	44	9.5	8.2	6.4	4.4	2.2
680	55	95	500	30	30	13.4	11.5	9.0	6.2	3.1
1000	40	65	350	22	22	17.2	14.8	11.6	8.0	4.0

▽ Variant with different case dimensions



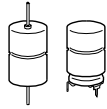

### Useful life

depending on ambient temperature  $T_A$  under ripple current operating conditions at  $V_R^{1)}$

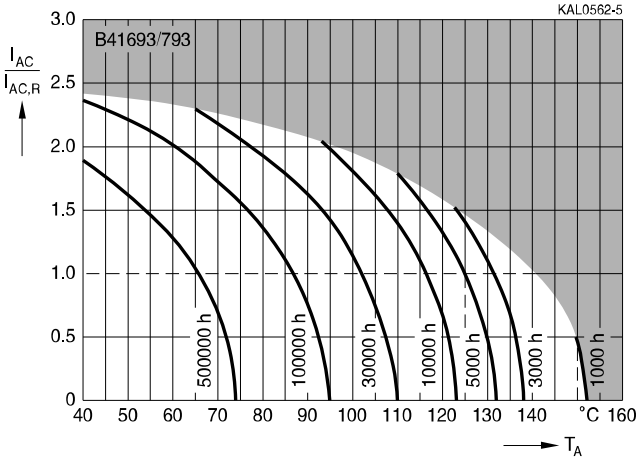

### Useful life

depending on case temperature  $T_C$  under ripple current operating conditions at  $V_R^{1)}$

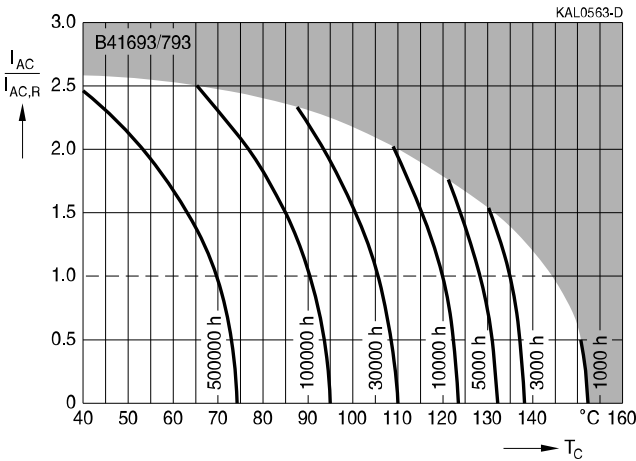

1) Refer to chapter "General technical information, 5.3 Calculation of useful life" for an explanation on how to interpret the useful life graphs.

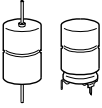

**B41693, B41793**

**Up to 150 °C**

**Frequency factor of permissible ripple current  $I_{AC}$  versus frequency  $f$**

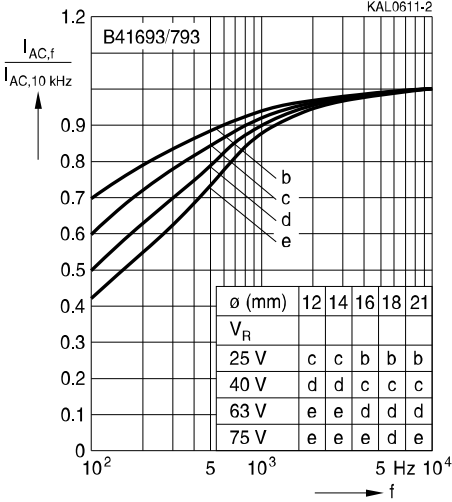

**Frequency characteristics of ESR**  
Typical behavior

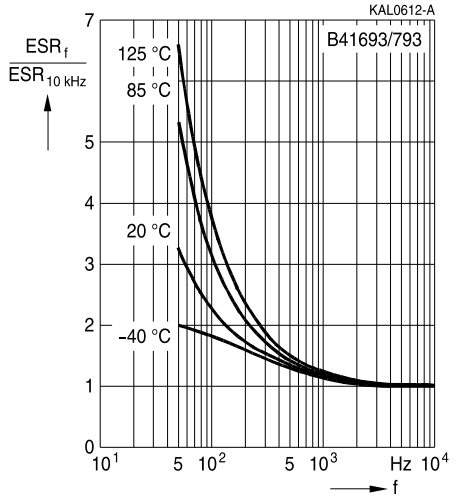

**Equivalent series resistance ESR versus frequency  $f$**

Typical behavior for 470  $\mu$ F/63V

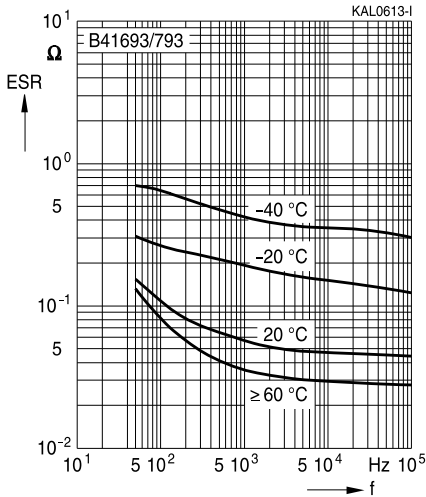

**Impedance  $Z$  versus frequency  $f$**

Typical behavior for 470  $\mu$ F/63V

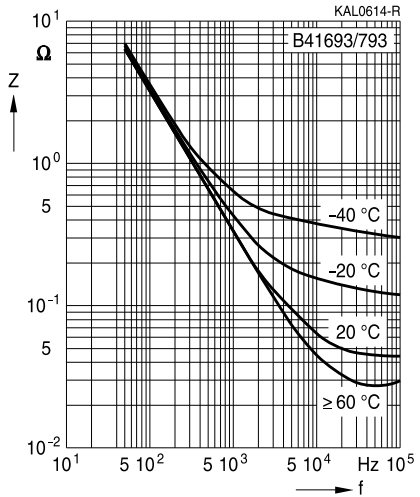

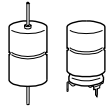

## Cautions and warnings

### Personal safety

The electrolytes used by EPCOS have not only been optimized with a view to the intended application, but also with regard to health and environmental compatibility. They do not contain any solvents that are detrimental to health, e.g. dimethyl formamide (DMF) or dimethyl acetamide (DMAC).

Furthermore, part of the high-voltage electrolytes used by EPCOS are self-extinguishing. They contain flame-retarding substances which will quickly extinguish any flame that may have been ignited.

As far as possible, EPCOS does not use any dangerous chemicals or compounds to produce operating electrolytes. However, in exceptional cases, such materials must be used in order to achieve specific physical and electrical properties because no safe substitute materials are currently known. However, the amount of dangerous materials used in our products has been limited to an absolute minimum. Nevertheless, the following rules should be observed when handling Al electrolytic capacitors:

- Any escaping electrolyte should not come into contact with eyes or skin.
- If electrolyte does come into contact with the skin, wash the affected parts immediately with running water. If the eyes are affected, rinse them for 10 minutes with plenty of water. If symptoms persist, seek medical treatment.
- Avoid breathing in electrolyte vapor or mists. Workplaces and other affected areas should be well ventilated. Clothing that has been contaminated by electrolyte must be changed and rinsed in water.

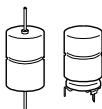
**B41693, B41793**
**Up to 150 °C**

### Product safety

The table below summarize the safety instructions that must be observed without fail. A detailed description can be found in the relevant sections of chapter "General technical information".

Topic	Safety information	Reference Chapter "General technical information"
Polarity	Make sure that polar capacitors are connected with the right polarity.	1 "Basic construction of aluminum electrolytic capacitors"
Reverse voltage	Voltages polarity classes should be prevented by connecting a diode.	3.1.6 "Reverse voltage"
Upper category temperature	Do not exceed the upper category temperatur.	7.2 "Maximum permissible operating temperature"
Maintenance	Make periodic inspections of the capacitors. Before the inspection, make sure that the power supply is turned off and carefully discharge the electricity of the capacitors. Do not apply any mechanical stress to the capacitor terminals.	10 "Maintenance"
Mounting position of screw terminal capacitors	Do not mount the capacitor with the terminals (safety vent) upside down.	11.1 "Mounting positions of capacitors with screw terminals"
Mounting of single-ended capacitors	The internal structure of single-ended capacitors might be damaged if excessive force is applied to the lead wires. Avoid any compressive, tensile or flexural stress. Do not move the capacitor after soldering to PC board. Do not pick up the PC board by the soldered capacitor. Do not insert the capacitor on the PC board with a hole space different to the lead space specified.	11.4 "Mounting considerations for single-ended capacitors"
Robustness of terminals	The following maximum tightening torques must not be exceeded when connecting screw terminals: M5: 2 Nm M6: 2.5 Nm	11.3 "Mounting torques"
Soldering	Do not exceed the specified time or temperature limits during soldering.	11.5 "Soldering"

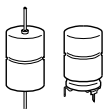

Topic	Safety information	Reference Chapter "General technical information"
Soldering, cleaning agents	Do not allow halogenated hydrocarbons to come into contact with aluminum electrolytic capacitors.	11.6 "Cleaning agents"
Passive flammability	Avoid external energy, such as fire or electricity.	8.1 "Passive flammability"
Active flammability	Avoid overload of the capacitors.	8.2 "Active flammability"
		Reference Chapter "Capacitors with screw terminals"
Breakdown strength of insulating sleeves	Do not damage the insulating sleeve, especially when ring clips are used for mounting.	"Screw terminals - accessories"

**B41693, B41793**
**Up to 150 °C**
**Symbols and terms**

Symbol	English	German
C	Capacitance	Kapazität
$C_R$	Rated capacitance	Nennkapazität
$C_S$	Series capacitance	Serienkapazität
$C_{S,T}$	Series capacitance at temperature T	Serienkapazität bei Temperatur T
$C_f$	Capacitance at frequency f	Kapazität bei Frequenz f
d	Case diameter, nominal dimension	Gehäusedurchmesser, Nennmaß
$d_{max}$	Maximum case diameter	Maximaler Gehäusedurchmesser
ESL	Self-inductance	Eigeninduktivität
ESR	Equivalent series resistance	Ersatzserienwiderstand
$ESR_f$	Equivalent series resistance at frequency f	Ersatzserienwiderstand bei Frequenz f
$ESR_T$	Equivalent series resistance at temperature T	Ersatzserienwiderstand bei Temperatur T
f	Frequency	Frequenz
I	Current	Strom
$I_{AC}$	Alternating current (ripple current)	Wechselstrom
$I_{AC,rms}$	Root-mean-square value of alternating current	Wechselstrom, Effektivwert
$I_{AC,f}$	Ripple current at frequency f	Wechselstrom bei Frequenz f
$I_{AC,max}$	Maximum permissible ripple current	Maximal zulässiger Wechselstrom
$I_{AC,R}$	Rated ripple current	Nennwechselstrom
$I_{AC,R} (B)$	Rated ripple current for base cooling	Nennwechselstromstrom für Bodenkühlung
$I_{leak}$	Leakage current	Ableitstrom
$I_{leak,op}$	Operating leakage current	Ableitstrom bei Betrieb
l	Case length, nominal dimension	Gehäuselänge, Nennmaß
$l_{max}$	Maximum case length (without terminals and mounting stud)	Maximale Gehäuselänge (ohne Anschlüsse und Gewindebolzen)
R	Resistance	Widerstand
$R_{ins}$	Insulation resistance	Isolationswiderstand
$R_{symm}$	Balancing resistance	Symmetrierwiderstand
T	Temperature	Temperatur
$\Delta T$	Temperature difference	Temperaturdifferenz
$T_A$	Ambient temperature	Umgebungstemperatur
$T_C$	Case temperature	Gehäusetemperatur
$T_B$	Capacitor base temperature	Temperatur des Becherbodens
t	Time	Zeit
$\Delta t$	Period	Zeitraum
$t_b$	Service life (operating hours)	Brauchbarkeitsdauer (Betriebszeit)

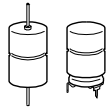

Symbol	English	German
V	Voltage	Spannung
V <sub>F</sub>	Forming voltage	Formierspannung
V <sub>op</sub>	Operating voltage	Betriebsspannung
V <sub>R</sub>	Rated voltage, DC voltage	Nennspannung, Gleichspannung
V <sub>S</sub>	Surge voltage	Spitzenspannung
X <sub>C</sub>	Capacitive reactance	Kapazitiver Blindwiderstand
X <sub>L</sub>	Inductive reactance	Induktiver Blindwiderstand
Z	Impedance	Scheinwiderstand
Z <sub>T</sub>	Impedance at temperature T	Scheinwiderstand bei Temperatur T
tan δ	Dissipation factor	Verlustfaktor
λ	Failure rate	Ausfallrate
ε <sub>0</sub>	Absolute permittivity	Elektrische Feldkonstante
ε <sub>r</sub>	Relative permittivity	Dielektrizitätszahl
ω	Angular velocity; 2 · π · f	Kreisfrequenz; 2 · π · f

### Notes

All dimensions are given in mm.

## Important notes

The following applies to all products named in this publication:

1. Some parts of this publication contain **statements about the suitability of our products for certain areas of application**. These statements are based on our knowledge of typical requirements that are often placed on our products in the areas of application concerned. We nevertheless expressly point out **that such statements cannot be regarded as binding statements about the suitability of our products for a particular customer application**. As a rule, EPCOS is either unfamiliar with individual customer applications or less familiar with them than the customers themselves. For these reasons, it is always ultimately incumbent on the customer to check and decide whether an EPCOS product with the properties described in the product specification is suitable for use in a particular customer application.
2. We also point out that **in individual cases, a malfunction of electronic components or failure before the end of their usual service life cannot be completely ruled out in the current state of the art, even if they are operated as specified**. In customer applications requiring a very high level of operational safety and especially in customer applications in which the malfunction or failure of an electronic component could endanger human life or health (e.g. in accident prevention or lifesaving systems), it must therefore be ensured by means of suitable design of the customer application or other action taken by the customer (e.g. installation of protective circuitry or redundancy) that no injury or damage is sustained by third parties in the event of malfunction or failure of an electronic component.
3. **The warnings, cautions and product-specific notes must be observed.**
4. In order to satisfy certain technical requirements, **some of the products described in this publication may contain substances subject to restrictions in certain jurisdictions (e.g. because they are classed as hazardous)**. Useful information on this will be found in our Material Data Sheets on the Internet ([www.epcos.com/material](http://www.epcos.com/material)). Should you have any more detailed questions, please contact our sales offices.
5. We constantly strive to improve our products. Consequently, **the products described in this publication may change from time to time**. The same is true of the corresponding product specifications. Please check therefore to what extent product descriptions and specifications contained in this publication are still applicable before or when you place an order. We also **reserve the right to discontinue production and delivery of products**. Consequently, we cannot guarantee that all products named in this publication will always be available. The aforementioned does not apply in the case of individual agreements deviating from the foregoing for customer-specific products.
6. Unless otherwise agreed in individual contracts, **all orders are subject to the current version of the "General Terms of Delivery for Products and Services in the Electrical Industry" published by the German Electrical and Electronics Industry Association (ZVEI)**.
7. The trade names EPCOS, BAOKE, Alu-X, CeraDiode, CSSP, CTVS, DSSP, MiniBlue, MKK, MLSC, MotorCap, PCC, PhaseCap, PhaseMod, SIFERRIT, SIFI, SIKOREL, SilverCap, SIMDAD, SIMID, SineFormer, SIOV, SIP5D, SIP5K, ThermoFuse, WindCap are **trademarks registered or pending** in Europe and in other countries. Further information will be found on the Internet at [www.epcos.com/trademarks](http://www.epcos.com/trademarks).



# Mouser Electronics

Authorized Distributor

Click to View Pricing, Inventory, Delivery & Lifecycle Information:

## EPCOS:

[B41693A5477Q007](#) [B41693A5108Q007](#) [B41693A5158Q007](#) [B41693A7337Q007](#) [B41693A7477Q007](#)  
[B41693A7687Q007](#) [B41693A7108Q007](#) [B41693A7158Q007](#) [B41693A8107Q007](#) [B41693A8227Q007](#)  
[B41693A8337Q007](#) [B41693A8477Q007](#) [B41693A8687Q007](#) [B41693A0107Q007](#) [B41693A0227Q007](#)  
[B41693A0477Q007](#) [B41693A5477Q009](#) [B41693A5108Q009](#) [B41693A7337Q009](#) [B41693A7477Q009](#)  
[B41693A7687Q009](#) [B41693A8107Q009](#) [B41693A8227Q009](#) [B41693A8337Q009](#) [B41693A0107Q009](#)  
[B41693A0227Q009](#) [B41793A5477Q000](#) [B41793A5108Q000](#) [B41793A5158Q000](#) [B41793A7337Q000](#)  
[B41793A7477Q000](#) [B41793A7687Q000](#) [B41793A7108Q000](#) [B41793A7158Q000](#) [B41793A8107Q000](#)  
[B41793A8227Q000](#) [B41793A8337Q000](#) [B41793A8477Q000](#) [B41793A8687Q000](#) [B41793A0107Q000](#)  
[B41793A0227Q000](#) [B41793A0477Q000](#)

Компания «Океан Электроники» предлагает заключение долгосрочных отношений при поставках импортных электронных компонентов на взаимовыгодных условиях!

Наши преимущества:

- Поставка оригинальных импортных электронных компонентов напрямую с производств Америки, Европы и Азии, а так же с крупнейших складов мира;
- Широкая линейка поставок активных и пассивных импортных электронных компонентов (более 30 млн. наименований);
- Поставка сложных, дефицитных, либо снятых с производства позиций;
- Оперативные сроки поставки под заказ (от 5 рабочих дней);
- Экспресс доставка в любую точку России;
- Помощь Конструкторского Отдела и консультации квалифицированных инженеров;
- Техническая поддержка проекта, помощь в подборе аналогов, поставка прототипов;
- Поставка электронных компонентов под контролем ВП;
- Система менеджмента качества сертифицирована по Международному стандарту ISO 9001;
- При необходимости вся продукция военного и аэрокосмического назначения проходит испытания и сертификацию в лаборатории (по согласованию с заказчиком);
- Поставка специализированных компонентов военного и аэрокосмического уровня качества (Xilinx, Altera, Analog Devices, Intersil, Interpoint, Microsemi, Actel, Aeroflex, Peregrine, VPT, Syfer, Eurofarad, Texas Instruments, MS Kennedy, Miteq, Cobham, E2V, MA-COM, Hittite, Mini-Circuits, General Dynamics и др.);

Компания «Океан Электроники» является официальным дистрибьютором и эксклюзивным представителем в России одного из крупнейших производителей разъемов военного и аэрокосмического назначения «JONHON», а так же официальным дистрибьютором и эксклюзивным представителем в России производителя высокотехнологичных и надежных решений для передачи СВЧ сигналов «FORSTAR».



## JONHON

«JONHON» (основан в 1970 г.)

Разъемы специального, военного и аэрокосмического назначения:

(Применяются в военной, авиационной, аэрокосмической, морской, железнодорожной, горно- и нефтедобывающей отраслях промышленности)

«FORSTAR» (основан в 1998 г.)

ВЧ соединители, коаксиальные кабели,  
кабельные сборки и микроволновые компоненты:

(Применяются в телекоммуникациях гражданского и специального назначения, в средствах связи, РЛС, а так же военной, авиационной и аэрокосмической отраслях промышленности).



Телефон: 8 (812) 309-75-97 (многоканальный)

Факс: 8 (812) 320-03-32

Электронная почта: [ocean@oceanchips.ru](mailto:ocean@oceanchips.ru)

Web: <http://oceanchips.ru/>

Адрес: 198099, г. Санкт-Петербург, ул. Калинина, д. 2, корп. 4, лит. А