

CliQ DIN Rail Power Supply

24V 60W 1 Phase / DRP024V060W1AA



Highlights & Features

- Universal AC input voltage
- Power will not de-rate for the entire input voltage range
- Power Boost of 150% for 3 seconds
- Full corrosion resistant aluminium chassis
- SEMI F47 certified
- Hazardous Locations approval to ATEX and Class I, Div 2

Safety Standards



CB Certified for worldwide use

| | |
|--------------------------------|--|
| Model Number: | DRP024V060W1AA |
| Unit Weight: | 0.37 kg (0.82 lb) |
| Dimensions (L x W x D): | 121 x 32 x 120 mm (4.76 x 1.26 x 4.72 inch) |

General Description

The DRP024V060W1AA is part of the CliQ DIN rail power supply series from one of the world's leading power supply companies, Delta Electronics Group. The rugged metal has a compact body at only 32mm, which is both shock and vibration resistant according to IEC 60068-2 standard. The product operates within a wide temperature range from -20°C to +80°C. The DRP024V060W1AA features universal AC input voltage range from 85Vac to 264Vac and the power will not de-rate for the entire input voltage range. The single phase power supply unit includes overvoltage, overcurrent, over temperature and short circuit protections. The product features built-in Power Boost of 150% for 3 seconds. Such feature enables reserve power to be always available for reliable startup of loads with high inrush current, thus eliminating the need of a more expensive power supply unit at higher power rating. Another great feature is the conformal coating on the PCBA which allows DRP024V060W1AA to be certified to ATEX and Class I, Div 2 for use in hazardous locations.

Model Information

CliQ DIN Rail Power Supply

| Model Number | Input Voltage Range | Rated Output Voltage | Rated Output Current |
|----------------|------------------------|----------------------|----------------------|
| DRP024V060W1AA | 85-264Vac (120-375Vdc) | 24Vdc | 2.50A |

Model Numbering

| DR | P | 024V | 060W | 1 | A | A |
|----------|--------------|----------------|--------------|--------------|-------------|------------|
| DIN Rail | Power Supply | Output Voltage | Output Power | Single Phase | CliQ Series | Metal Case |

CliQ DIN Rail Power Supply

24V 60W 1 Phase / DRP024V060W1AA

Specifications

Input Ratings / Characteristics

| | |
|---------------------------------|------------------------------------|
| Nominal Input Voltage | 100-240Vac |
| Input Voltage Range | 85-264Vac |
| Nominal Input Frequency | 50-60Hz |
| Input Frequency Range | 47-63Hz |
| DC Input Voltage Range* | 120-375Vdc |
| Input Current | < 1.10A @ 115Vac, < 0.70A @ 230Vac |
| Efficiency at 100% Load | > 86.0% @ 115Vac, > 87.0% @ 230Vac |
| Max Inrush Current (Cold Start) | < 40A @ 115Vac, < 80A @ 230Vac |
| Leakage Current | < 1mA @ 240Vac |

*Safety approval according to IEC/EN/UL 60950-1.

Output Ratings / Characteristics

| | |
|---|--|
| Nominal Output Voltage | 24Vdc |
| Output Voltage Tolerance | ± 2% (initial set point tolerance from factory) |
| Output Voltage Adjustment Range | 22-28Vdc |
| Output Current | 2.50A (continuously operating at 24V) 3.75A (Power Boost for 3 seconds at 24V, refer to the details in the Functions section) |
| Output Power | 60W (continuously operating at 24V) 90W (Power Boost for 3 seconds at 24V, refer to the details in the Functions section) |
| Line Regulation | < 0.5% typ. (@ 85-264Vac input, 100% load) |
| Load Regulation | < 1% typ. (@ 85-264Vac input, 0-100% load) |
| PARD (20MHz) | < 240mVpp |
| Rise Time | < 100ms @ nominal input (100% load) |
| Start-up Time | < 3,000ms @ nominal input (100% load) |
| Hold-up Time | > 20ms @ 115Vac, > 125ms @ 230Vac (100% load) |
| Dynamic Response (Overshoot & Undershoot O/P Voltage) | ± 5% @ 10-100% load |
| Start-up with Capacitive Loads | 8,000µF Max |

CliQ DIN Rail Power Supply

24V 60W 1 Phase / DRP024V060W1AA

Mechanical

| | |
|-----------------------------------|---|
| Case Cover / Chassis | Aluminium |
| Dimensions (L x W x D) | 121 x 32 x 120 mm (4.76 x 1.26 x 4.72 inch) |
| Unit Weight | 0.37 kg (0.82 lb) |
| Indicator | Green LED (DC OK) |
| Cooling System | Convection |
| Terminal | Input 3 Pins (Rated 300V/20A) Output 2 Pins (Rated 300V/20A) |
| Wire | AWG 22-14 |
| Mounting Rail | Standard TS35 DIN Rail in accordance with EN 60715 |
| Noise (1 Meter from power supply) | Sound Pressure Level (SPL) < 40dBA |

Environment

| | | |
|-----------------------------|---|---|
| Surrounding Air Temperature | Operating | -20°C to +80°C |
| | Storage | -25°C to +85°C |
| Power De-rating | Vertical Mounting | < 0°C de-rate power by 1% / °C, > 50°C de-rate power by 2.5% / °C |
| | Horizontal Mounting | < 0°C de-rate power by 1% / °C, > 50°C de-rate power by 2.5% / °C > 70°C de-rate power by 4% / °C |
| Operating Humidity | 5 to 95% RH (Non-Condensing) | |
| Operating Altitude | 0 to 2,000 Meters (6,560 ft) (@ 50°C) | |
| Shock Test (Non-Operating) | IEC 60068-2-27, 30G (300m/S ²) for a duration of 18ms, 3 times per direction, 18 times in total | |
| Vibration (Non-Operating) | IEC 60068-2-6, 10Hz to 150Hz @ 50m/S ² (5G peak); 90 min per axis for all X, Y, Z direction | |
| Pollution Degree | 2 | |

Protections

| | |
|--------------------------|--|
| Overvoltage | 32V ±10%, SELV Output, Hiccup Mode, Non-Latching (Auto-Recovery) |
| Overload / Overcurrent | > 150% of rated load current, Hiccup Mode, Non-Latching (Auto-Recovery) |
| Over Temperature | < 80°C Surrounding Air Temperature @ 100% load, Non-Latching (Auto-Recovery) |
| Short Circuit | Hiccup Mode, Non-Latching (Auto-Recovery when the fault is removed) |
| Protection Against Shock | Class I with PE* connection |

*PE: Primary Earth

Reliability Data

| | |
|------------------------|---|
| MTBF | > 500,000 hrs. as per Telcordia SR-332 I/P: 115Vac, O/P: 100% load, Ta: 25°C |
| Expected Cap Life Time | 10 years (115Vac & 230Vac, 50% load @ 40°C) |

CliQ DIN Rail Power Supply

24V 60W 1 Phase / DRP024V060W1AA

Safety Standards / Directives

| | | |
|---|---|---------|
| Electrical Equipment in Power Installations | EN 50178 / IEC 62103 | |
| Electrical Safety | SIQ to EN 60950-1, UL/cUL recognized to UL 60950-1 and CSA C22.2 No. 60950-1 (under alternate part number EOE11010006 of File No. E191395), CSA to CSA C22.2 No. 60950-1 and UL 60950-1, CB scheme to IEC 60950-1 | |
| Industrial Control Equipment | UL/cUL listed to UL 508 and CSA C22.2 No. 107.1-01 (under alternate part number EOE11010006 of File No. E315355), CSA to CSA C22.2 No. 107.1-01 (under alternate part number EOE11010006 of File No. 181564) | |
| Hazardous Location / ATEX | cCSAus to CSA C22.2 No. 213-M1987 and ANSI / ISA 12.12.01:2007 Class I, Division 2, Group A, B, C, D T4, Ta= -20°C to +80°C (> +50°C derating) EN 60079-0:2009, EN 60079-15:2010 (⊕ II 3G Ex nA IIC T4 Gc, Ta= -20°C to +80°C (> +50°C derating)) | |
| ⊕ II 3G ATEX 94/9/EC; IECEx test report | Certificate No. EPS 09 ATEX 1 215 X; For IEC 60079-0, IEC 60079-15 | |
| CE | In conformance with EMC Directive 2014/30/EU and Low Voltage Directive 2014/35/EU In conformance with Equipment for explosive atmospheres (ATEX) directive 2014/34/EU | |
| Material and Parts | RoHS Directive 2011/65/EU Compliant | |
| Galvanic Isolation | Input to Output | 4.0KVac |
| | Input to Ground | 1.5KVac |
| | Output to Ground | 1.5KVac |

CliQ DIN Rail Power Supply

24V 60W 1 Phase / DRP024V060W1AA

EMC

| | | |
|-----------------------------------|----------------|--|
| EMC / Emissions | | CISPR 32, EN 55032, EN 55011, FCC Title 47: Class B |
| Immunity to | | EN 55024 |
| Electrostatic Discharge | IEC 61000-4-2 | Level 4 Criteria A ¹⁾ Air Discharge: 15kV Contact Discharge: 8kV |
| Radiated Field | IEC 61000-4-3 | Level 3 Criteria A ¹⁾ 80MHz-1GHz, 10V/M, 80% modulation (1kHz) |
| Electrical Fast Transient / Burst | IEC 61000-4-4 | Level 3 Criteria A ¹⁾ 2kV |
| Surge | IEC 61000-4-5 | Level 3 Criteria A ¹⁾ Common Mode ²⁾ : 2kV Differential Mode ³⁾ : 2kV |
| Conducted | IEC 61000-4-6 | Level 3 Criteria A ¹⁾ 150kHz-80MHz, 10Vrms |
| Power Frequency Magnetic Fields | IEC 61000-4-8 | Criteria A ¹⁾ 1A/Meter |
| Voltage Dips | IEC 61000-4-11 | 100% dip; 1 cycle (20ms); Self Recoverable |
| Low Energy Pulse Test (Ring Wave) | IEC 61000-4-12 | Level 3 Criteria A ¹⁾ Common Mode ²⁾ : 2kV Differential Mode ³⁾ : 1Kv |
| Voltage Fluctuation and Flicker | | IEC/EN 61000-3-3 |
| Voltage Sag Immunity | | SEMI F47 - 0706, at 110Vac |

1) Criteria A: Normal performance within the specification limits

2) Asymmetrical: Common mode (Line to earth)

3) Symmetrical: Differential mode (Line to line)

CliQ DIN Rail Power Supply

24V 60W 1 Phase / DRP024V060W1AA

Block Diagram

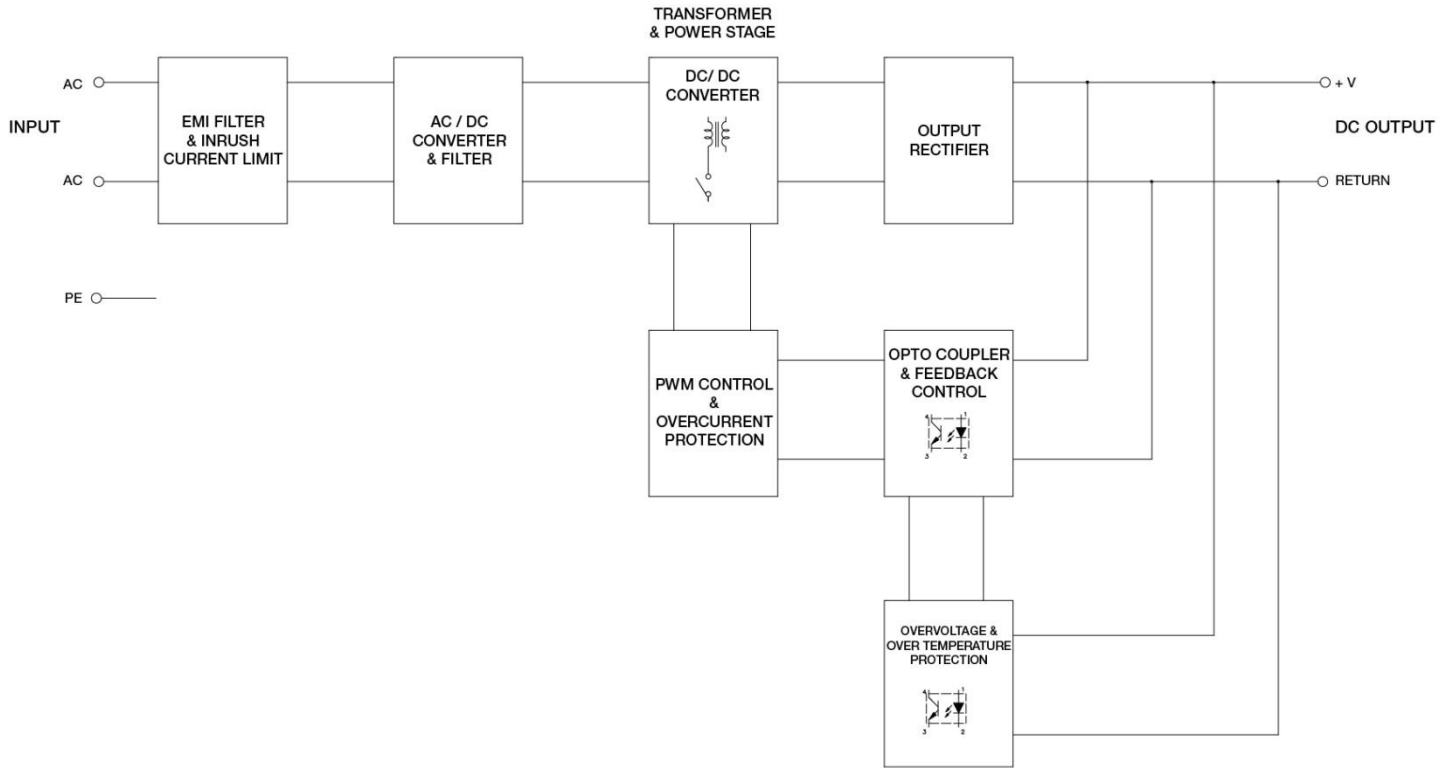

Device Description

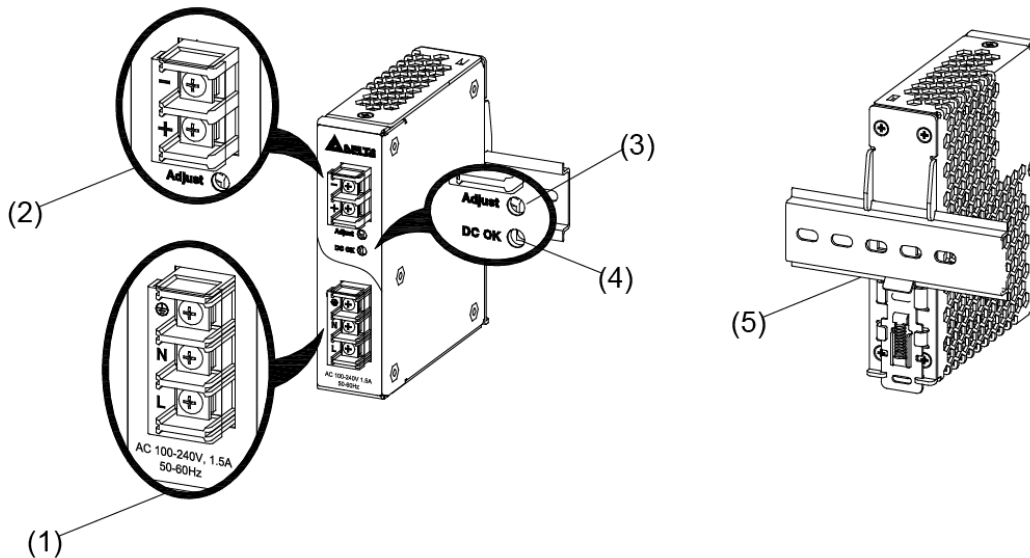

- 1) Input terminal block connector
- 2) Output terminal block connector
- 3) DC Voltage adjustment potentiometer
- 4) DC OK control LED (Green)
- 5) Universal mounting rail system

CliQ DIN Rail Power Supply

24V 60W 1 Phase / DRP024V060W1AA

Dimensions

L x W x D: 121 x 32 x 120 mm (4.76 x 1.26 x 4.72 inch)

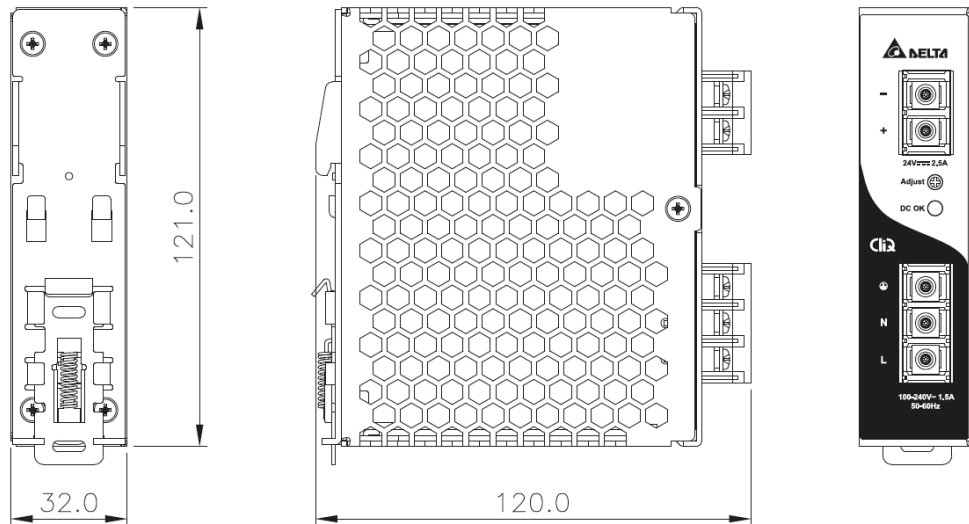

Engineering Data

Output Load De-rating VS Surrounding Air

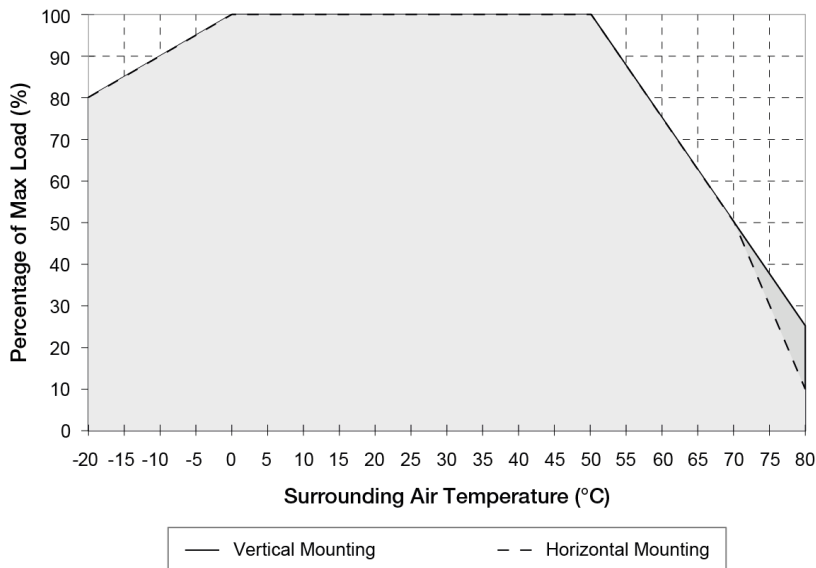

Fig. 1 De-rating for Vertical Mounting Orientation

< 0°C de-rate power by 1% / °C,
> 50°C de-rate power by 2.5% / °C

De-rating for Horizontal Mounting Orientation

< 0°C de-rate power by 1% / °C,
> 50°C de-rate power by 2.5% / °C,
> 70°C de-rate power by 4% / °C

Note

1. Power supply components may degrade, or be damaged, when the power supply is continuously used outside the shaded region, refer to the graph shown in Fig. 1.
2. If the output capacity is not reduced when the surrounding air temperature > 50°C, the device may run into Over Temperature Protection. When activated, the output voltage will go into bouncing mode and will recover when the surrounding air temperature is lowered or the load is reduced as far as necessary to keep the device in working condition.
3. In order for the device to function in the manner intended, it is also necessary to keep a safety distance of 20mm (for Vertical Mounting) or 50mm (for Horizontal Mounting) with adjacent units while the device is in operation.
4. Depending on the surrounding air temperature and output load delivered by the power supply, the device can be very hot!
5. If the device has to be mounted in any other orientation, please do not hesitate to contact info@deltapsu.com for more details.

CliQ DIN Rail Power Supply

24V 60W 1 Phase / DRP024V060W1AA

Output Load De-rating VS. Input Voltage

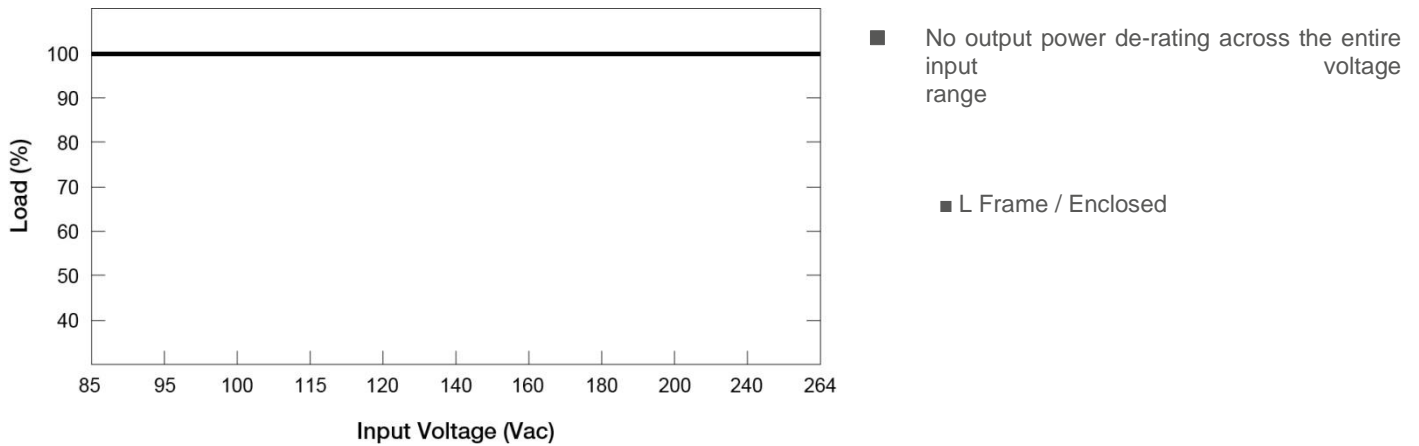

Assembly & Installation

The power supply unit (PSU) can be mounted on 35mm DIN rails in accordance with EN 60715. The device should be installed with input terminal block at the bottom.

Each device is delivered ready to install.

Mounting

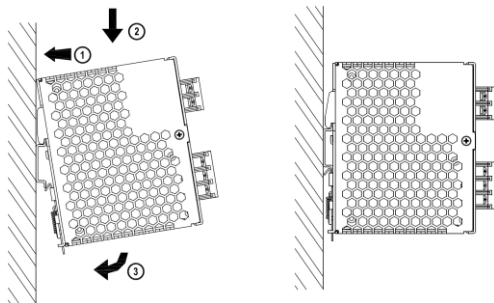

Fig. 2.1 Mounting

Snap on the DIN rail as shown in Fig. 2.1:

1. Tilt the unit upwards and insert it onto the DIN rail.
2. Push downwards until stopped.
3. Press against the bottom front side for locking.
4. Shake the unit slightly to ensure that it is secured.

Dismounting

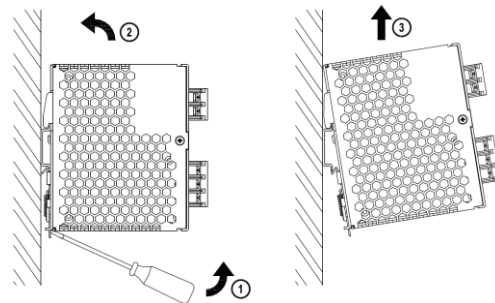

Fig. 2.2 Dismounting

To uninstall, pull or slide down the latch with screw driver as shown in Fig. 2.2. Then slide the power supply unit (PSU) in the opposite direction, release the latch and pull out the power supply unit (PSU) from the rail.

In accordance to EN 60950 / UL 50950, flexible cables require ferrules.

Use appropriate copper cables designed to sustain operating temperature of at least 75°C or more to fulfill UL requirements.

For stranded wires it is recommended to use suitable lug to crimp wires.

CliQ DIN Rail Power Supply

24V 60W 1 Phase / DRP024V060W1AA

Safety Instructions

■ Vertical Mounting

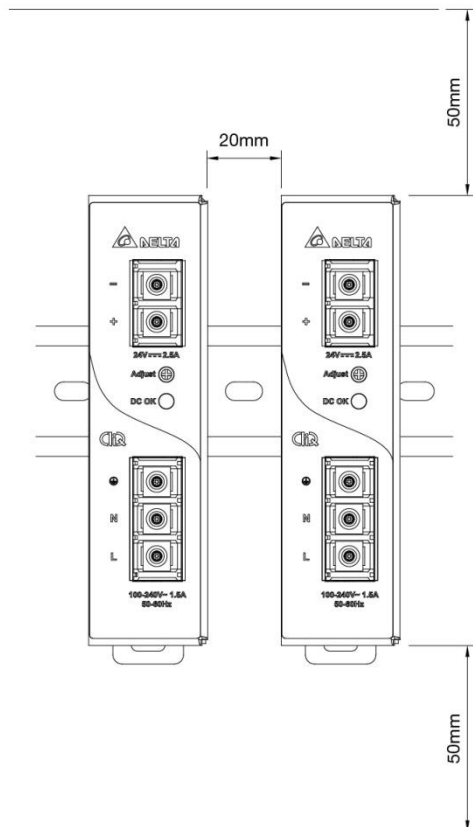

■ Horizontal Mounting

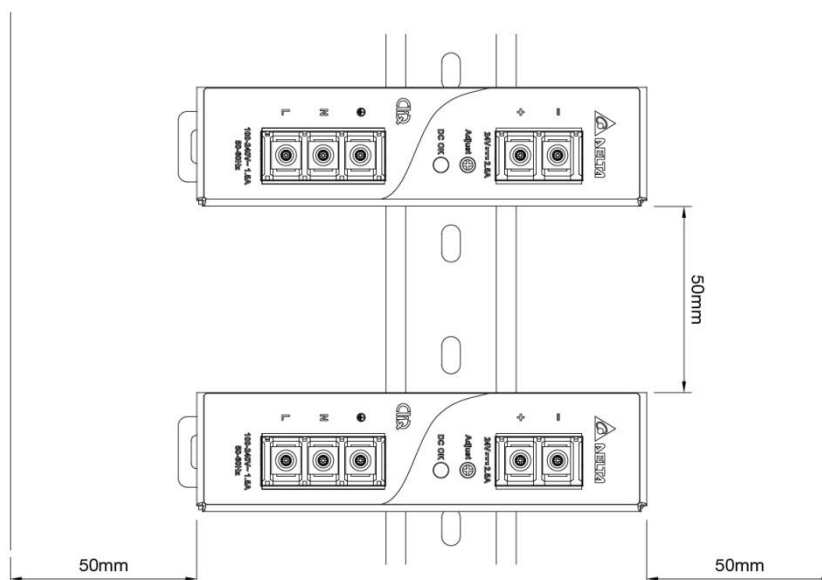

- ALWAYS switch mains of input power OFF before connecting and disconnecting the input voltage to the unit. If mains are not turned OFF, there is risk of explosion / severe damage.
- **To guarantee sufficient convection cooling, keep a distance of 50mm above and below the device as well as a lateral distance of 20mm (for Vertical Mounting) or 50mm (for Horizontal Mounting) to other units.**
- Note that the enclosure of the device can become very hot depending on the surrounding air temperature and load of the power supply. Risk of burns!
- Only plug in and unplug connectors when power is turned off!
- DO NOT insert any objects into the unit.
- Hazardous voltages may be present for up to 5 minutes after the input mains voltage is disconnected. Do not touch the unit during this time.
- The power supplies unit must be installed in an IP54 enclosure or cabinet in the final installation. The enclosure or cabinet must comply with EN 60079-0 or EN 60079-15.
- CAUTION: "For use in a controlled environment".
- Warning: Explosion Hazard - Substitution of components may impair suitability for Class I, Division 2.
- Warning: Explosion Hazard - Do not disconnect equipment unless the power has been switched off or the area is known to be non-hazardous.

CliQ DIN Rail Power Supply

24V 60W 1 Phase / DRP024V060W1AA

Functions

■ Graph illustrating the Start-up Time, Rise Time, and Hold-up Time

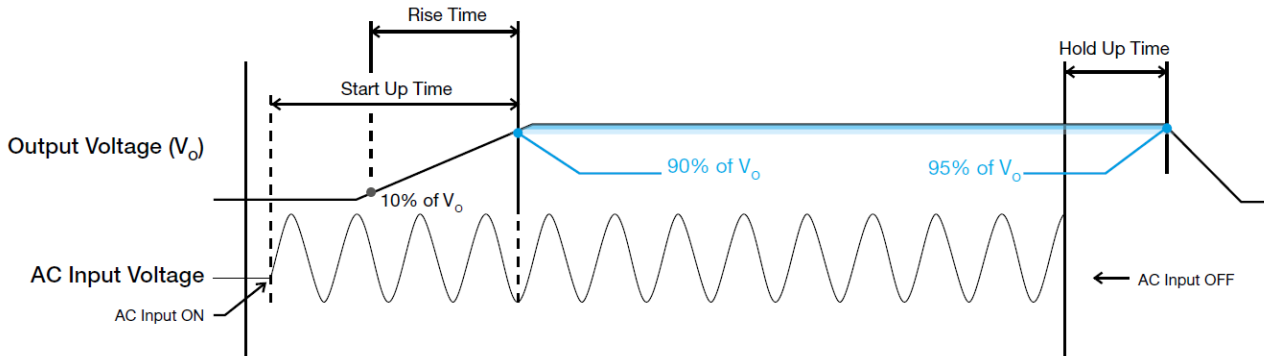

Start-up Time

The time required for the output voltage to reach 90% of its set value, after the input voltage is applied.

Rise Time

The time required for the output voltage to change from 10% to 90% of its set value.

Hold-up Time

Hold up time is the time when the AC input collapses and output voltage retains regulation for a certain period of time. The time required for the output to reach 90% of its set value, after the input voltage is removed.

Inrush Current

Inrush current is the peak, instantaneous, input current measured and, occurs when the input voltage is first applied. For AC input voltages, the maximum peak value of inrush current will occur during the first half cycle of the applied AC voltage. This peak value decreases exponentially during subsequent cycles of AC voltage.

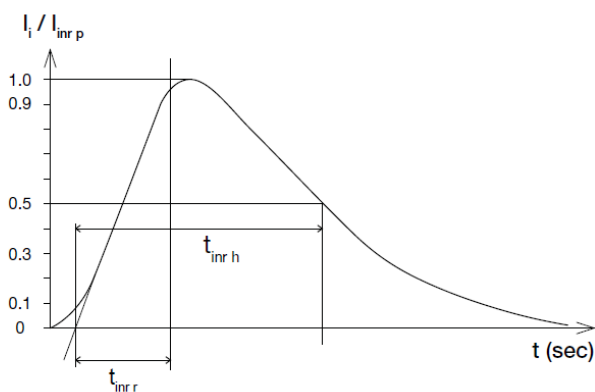

Dynamic Response

The power supply output voltage will remain within $\pm 5\%$ of its steady state value, when subjected to a dynamic load from 10 to 100% of its rated current.

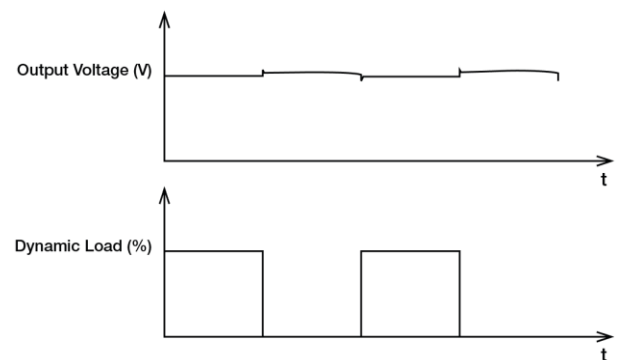

CliQ DIN Rail Power Supply

24V 60W 1 Phase / DRP024V060W1AA

Power Boost

Power Boost is the reserve power available constantly that allows reliable startup to support sudden and short spike of loads with high inrush current typically during turn on to remove the need of more expensive higher rated power supply unit. After the output has reached its steady state set value, the power supply can support surge loads with a higher short-term power demand up to 150% of maximum rated load (I_o Max), for a maximum duration of 3 seconds. The Power Boost is also available to repeatedly basis with according to the condition of an average (R.M.S) output power shall not exceed continuous operating condition or refer to duty cycle calculation below.

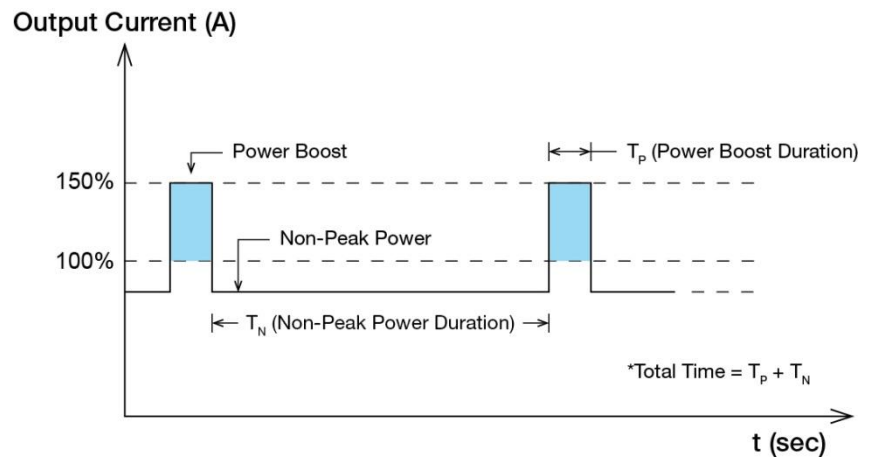

$$Duty\ cycle\ (\%) = \frac{T_p}{Total\ Time}$$

$$Average\ Output\ Power\ (P_{Avg}) = \frac{(Power\ Boost \times T_p) + (Non-Peak\ Power \times T_n)}{Total\ Time}$$

OR

$$Non-Peak\ Power = \frac{(P_{Avg} \times Total\ Time) - (Power\ Boost \times T_p)}{T_n}$$

■ An example of Power Boost and Average Output Power

| Power Boost | Peak Power (W _P) | Power Boost Duration (T _P) | Duty Cycle | Non-Peak Power (W _N) | Non-Peak Power Duration (T _N) | Total Time (T) |
|-------------|------------------------------|--|------------|----------------------------------|---|----------------|
| 150% | 90 | 3 sec | 10% | 57W | 27 sec | 30 sec |
| 150% | 90 | 3 sec | 35% | 44W | 5.5 sec | 8.5 sec |
| 120% | 72 | 6 sec | 20% | 57W | 24 sec | 30 sec |
| 120% | 72 | 6 sec | 35% | 53W | 11 sec | 17 sec |

It is not recommended to prolong the duration of Power Boost to be longer than the specified duty cycle calculation, this may cause damage to the PSU.

CliQ DIN Rail Power Supply

24V 60W 1 Phase / DRP024V060W1AA

Overload & Overcurrent Protections

The power supply's Overload (OLP) and Overcurrent (OCP) Protections will be activated when output current exceeds 150% of I_o (Max load). In such occurrence, the V_o will start to droop and once the power supply has reached its maximum power limit, the protection is activated and the power supply will go into "Hiccup mode" (Auto-Recovery). The power supply will recover once the fault condition of the OLP and OCP is removed and I_o is back within the specifications.

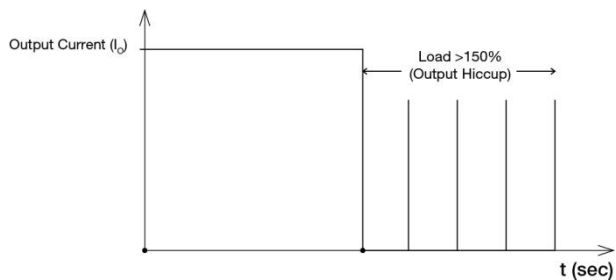

It is not recommended to prolong the duration of I_o when it is <150% but >100%, since it may cause damage to the PSU.

Short Circuit Protection

The power supply's output OLP/OCP function also provides protection against short circuits. When a short circuit is applied, the output current will operate in "Hiccup mode", as shown in the illustration in the OLP/OCP section on this page. The power supply will return to normal operation after the short circuit is removed.

Overvoltage Protection

The power supply's overvoltage circuit will be activated when its internal feedback circuit fails. The output voltage shall not exceed its specifications defined on Page 3 under "Protections". The power supply doesn't shut down but goes in 2nd level regulation at 30-32Vdc and continue to deliver the power. According to high output voltage which will be operating > 100% of rated load (32V x rated output current), if this condition persists, the power supply will sense OTP (Over Temperature Protection) and will go under hiccup mode. The power will return to normal operation once the fault condition is removed.

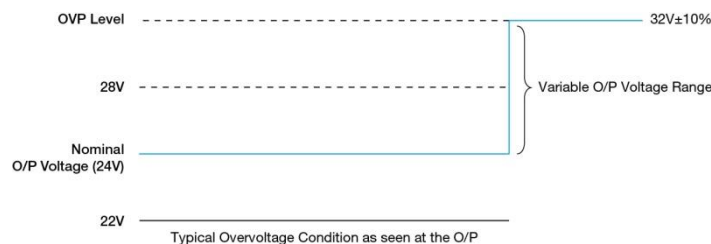

Over Temperature Protection

As mentioned above, the power supply also has Over Temperature Protection (OTP). In the event of a higher operating temperature at 100% load, the power supply will run into OTP when the operating temperature is beyond what is recommended in the de-rating graph. When activated, the output voltage will go into bouncing mode until the temperature drops to its normal operating temperature as recommended in the de-rating graph.



CliQ DIN Rail Power Supply

24V 60W 1 Phase / DRP024V060W1AA

Operating Mode

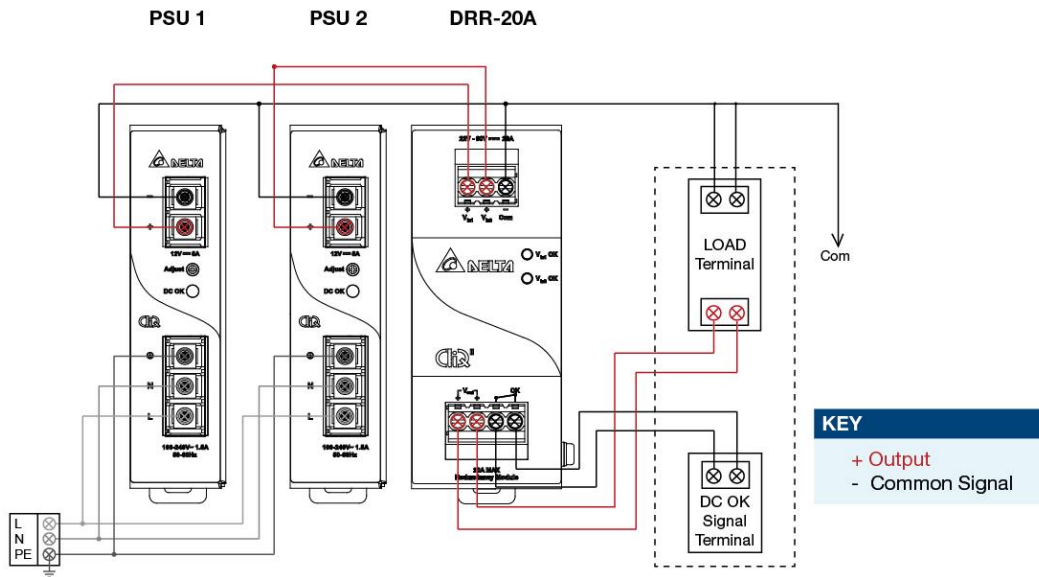

Fig. 3 Redundancy / Parallel Operation Connection Diagram

■ Redundancy Operation

In order to ensure proper redundancy operation for the power supply unit (PSU), ensure that the output voltage difference between the two units is kept at 0.45~0.50V for 24V supplies. Follow simple steps given below to verify:

Step 1.

Measure output voltage of PSU 1 and PSU 2. If PSU 1 is the master unit, then V_O of PSU 1 must be higher than PSU 2.

In order to set the output voltage, connect the power supply to 50% load and set the PSU 1 and PSU 2 output voltage.

Step 2.

Connect the right DRR module, 20A as per the system requirement to the power supply units PSU 1 and PSU 2 at $V_{in 1}$ & $V_{in 2}$ respectively.

Step 3.

Connect the system load from V_{out} . Please note that output voltage V_{out} from DRR module will be = V_O (output voltage of power supply) - V_{drop}^* (in DRR module).

■ Parallel Operation

These DRR modules can also be used for Parallel function in order to increase the output power by N+1 (e.g. $2.5A + 2.5A = 5A$ or $2.5A + 2.5A + 2.5A = 7.5A$) or current sharing, and thus increasing the power supply and system reliability. Though the DRP024V060W1AA is not designed for current sharing, a good current sharing between two power supplies can be achieved by following simple steps as below (Refer to Fig. 3 for the Connection Diagram).

Step 1.

Set output load condition for both supplies at 50% and measure the output voltages.

Step 2.

Adjust output voltages to the same level or within $\pm 25mV$ difference.

Step 3.

Connect PSU 1 and PSU 2 with the DRR-20A module and measure at $V_{in 1}$ & $V_{in 2}$ to verify the voltage difference. Ensure the voltages are within $\pm 25mV$.

Step 4.

Output voltage from DRR module V_{out} will be = V_O (output voltage of power supply) - V_{drop}^* (in DRR module).

* V_{drop} will vary from 0.60V to 0.90V (Typical 0.65V) depending on the load current and surrounding air temperature.

CliQ DIN Rail Power Supply

24V 60W 1 Phase / DRP024V060W1AA

Others

Delta RoHS Compliant



Restriction of the usage of hazardous substances

The European directive 2011/65/EU limits the maximum impurity level of homogeneous materials such as lead, mercury, cadmium, chrome, polybrominated flame retardants PBB and PBDE for the use in electrical and electronic equipment. RoHS is the abbreviation for "Restriction of the use of certain hazardous substances in electrical and electronic equipment".

This product conforms to this standard.

Conformal Coating

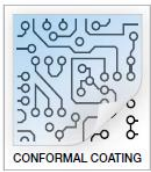

The Protective Coating Technology

Delta Electronics Group has designed the perfect dipping technique which penetrates everywhere including under device, and prevents leakage. The conformal coating dipping can be applied to PCBAs or circuit board. The coating preserves the performance of precision electronic primarily by preventing ionizable contaminants such as salt from reaching circuit nodes, where the material slumps around sharp edges. This can be a problem especially in highly conversing atmosphere.

Attention

Delta provides all information in the datasheets on an "AS IS" basis and does not offer any kind of warranty through the information for using the product. In the event of any discrepancy between the information in the catalog and datasheets, the datasheets shall prevail (please refer to www.DeltaPSU.com for the latest datasheets information). Delta shall have no liability of indemnification for any claim or action arising from any error for the provided information in the datasheets. Customer shall take its responsibility for evaluation of using the product before placing an order with Delta.

Delta reserves the right to make changes to the information described in the datasheets without notice.

Компания «Океан Электроники» предлагает заключение долгосрочных отношений при поставках импортных электронных компонентов на взаимовыгодных условиях!

Наши преимущества:

- Поставка оригинальных импортных электронных компонентов напрямую с производств Америки, Европы и Азии, а так же с крупнейших складов мира;
- Широкая линейка поставок активных и пассивных импортных электронных компонентов (более 30 млн. наименований);
- Поставка сложных, дефицитных, либо снятых с производства позиций;
- Оперативные сроки поставки под заказ (от 5 рабочих дней);
- Экспресс доставка в любую точку России;
- Помощь Конструкторского Отдела и консультации квалифицированных инженеров;
- Техническая поддержка проекта, помощь в подборе аналогов, поставка прототипов;
- Поставка электронных компонентов под контролем ВП;
- Система менеджмента качества сертифицирована по Международному стандарту ISO 9001;
- При необходимости вся продукция военного и аэрокосмического назначения проходит испытания и сертификацию в лаборатории (по согласованию с заказчиком);
- Поставка специализированных компонентов военного и аэрокосмического уровня качества (Xilinx, Altera, Analog Devices, Intersil, Interpoint, Microsemi, Actel, Aeroflex, Peregrine, VPT, Syfer, Eurofarad, Texas Instruments, MS Kennedy, Miteq, Cobham, E2V, MA-COM, Hittite, Mini-Circuits, General Dynamics и др.);

Компания «Океан Электроники» является официальным дистрибьютором и эксклюзивным представителем в России одного из крупнейших производителей разъемов военного и аэрокосмического назначения «**JONHON**», а так же официальным дистрибьютором и эксклюзивным представителем в России производителя высокотехнологичных и надежных решений для передачи СВЧ сигналов «**FORSTAR**».



JONHON

«**JONHON**» (основан в 1970 г.)

Разъемы специального, военного и аэрокосмического назначения:

(Применяются в военной, авиационной, аэрокосмической, морской, железнодорожной, горно- и нефтедобывающей отраслях промышленности)

«**FORSTAR**» (основан в 1998 г.)

ВЧ соединители, коаксиальные кабели, кабельные сборки и микроволновые компоненты:

(Применяются в телекоммуникациях гражданского и специального назначения, в средствах связи, РЛС, а так же военной, авиационной и аэрокосмической отраслях промышленности).



Телефон: 8 (812) 309-75-97 (многоканальный)

Факс: 8 (812) 320-03-32

Электронная почта: ocean@oceanchips.ru

Web: <http://oceanchips.ru/>

Адрес: 198099, г. Санкт-Петербург, ул. Калинина, д. 2, корп. 4, лит. А