

# DURA-CON

All-Plastic

Strip Connectors

Metal Shell

Mil-C-83513 Connectors

Terminal Blocks

Microedge

.050" D-microminiature



**Cinch**

Cinch Dura-Con™ connectors are designed for applications that require a rugged, durable, and high-performance interconnect. Dura-Con is the ideal connector for applications where weight and space must be kept to a minimum while maintaining maximum reliability. Miniaturized airborne electronics and data processing equipment, where shorter signal paths are needed, represent typical applications for these unique connectors.

The heart of the Dura-Con system is the Dura-Con pin contact. The Cinch Dura-Con pin contact is made from a precision miniature spring cable with a welded tip. The expanded cable provides seven spring members peripherally around the pin so that contact is maintained with the mating socket wall no matter what radial forces are applied. This spring may be flexed many times without any evidence of metal fatigue. Reliable mating is further ensured by protecting the pin contact in a tightly tolerated recessed cavity.

Cinch's family of Dura-Con connectors includes MIL-C-83513 Series connectors along with our own commercial equivalents. The commercial Dura-Con product line offers an expanded range of termination and hardware options for all-plastic and metal shell wire versions and right-angle and straight PC board mount "terminal blocks". Cinch also packages the Dura-Con contact in a very low profile plastic strip connector on .050" centers and in a line of high-density microminiature edge (Microedge) board connectors that meet the requirements of MIL-C-55302. Cinch has created a line of plastic and metal shell Dura-Con connector savers for very high mating cycle applications such as test equipment.

### Termination Options:

Cinch offers the following termination methods for its Dura-Con connectors:

Insulated Wire - Insulated wire is crimped to the Dura-Con contacts then epoxy backpotted at the factory. Wire is available in standard lengths of 18, 24, 36, and 48 inches.

Uninsulated Wire - 24 AWG, gold-plated, uninsulated wire is crimped to the Dura-Con contact at the factory. Wire is available in standard lengths of 0.5, 1.0, and 2.0 inches. This option allows the user greater flexibility when installing the connector.

Solder Cup - For applications that require the lowest contact resistance, Cinch offers Dura-Con connectors with solder cups for termination by the user.



Dura-Con is a trademark of Cinch Connectors.

**Custom Capabilities:**

Standard Cinch Dura-Con connectors satisfy a wide variety of applications. Cinch's line of Dura-Con D-microminiature connectors is one of the most versatile in the industry. There are over 50,000 possible combinations of Cinch standard options such as connector type, size, materials, hardware, and termination.

When special application requirements arise, Cinch Dura-Con connectors take this versatility to the next level. Whether specific needs entail new variations of simple end-to-end connector assemblies or more complex and intricate harness assemblies, Cinch Connector Division has the state-of-the-art engineering resources and research facilities in place to meet your needs. Cinch approaches your business with a well-defined goal: to ensure the integrity of your design and to execute our contribution to it in a responsible, cost-effective manner. This philosophy has led Cinch to a position of industry leadership.

For complete information regarding the total capabilities of the Dura-Con connector series, or for custom application assistance, contact your nearest Cinch Connectors sales office.



5

**Dura-Con**  
**High Reliability**  
**All-Plastic**

.050" (1.27mm) Density  
 Solder Cup/Wire  
 D-Microminiature



FEATURES

- Both plug and socket available in 9, 15, 21, 25, 31, 37, and 51 positions.
- Termination styles - solder cup, gold-plated solid wire, and insulated stranded wire.
- Several styles of mounting hardware are available for cable-to-cable, cable-to-board mount, and cable-to-panel mount applications.
- High-performance Dura-Con twist-pin contact.
- Economical all-plastic shell for lightweight applications where no shielding is required.
- Meets requirements of MIL-C-83513 except where noted.



MATERIALS

**Insulator:** UL94V-0 rated glass-filled polyester  
**Contacts:** Pins - Copper alloy, Sockets - Copper alloy (machined)  
**Contact Plating:** .000050 in gold

ENVIRONMENTAL

**Operating Temperature:** -55° C to +135° C

ELECTRICAL

**Current Rating:** 3 Amps maximum  
**Withstanding Voltage:** 600 VAC RMS @ sea level  
**Contact Resistance:** 8 milliohms maximum change

MECHANICAL

**Individual Contact:** 6 oz. (170.40 g) maximum insertion;  
 0.5 oz. (14.20 g) minimum withdrawal  
**Mating / Unmating Force:** See table

| No. of Contacts | Maximum Mating Force |       | Minimum Unmating Force |     |
|-----------------|----------------------|-------|------------------------|-----|
|                 | Lb.                  | Kg    | Lb.                    | Kg  |
| 9               | 5.63                 | 2.56  | .28                    | .13 |
| 15              | 9.38                 | 4.26  | .47                    | .21 |
| 21              | 13.13                | 5.96  | .66                    | .30 |
| 25              | 15.63                | 7.10  | .78                    | .35 |
| 31              | 19.38                | 8.80  | .97                    | .44 |
| 37              | 23.13                | 10.50 | 1.16                   | .53 |
| 51              | 31.88                | 14.47 | 1.59                   | .72 |

**Contact Arrangements**  
 (Face view of pin insulator)  
 (Use reverse order for socket)



**Ordering Information**



\* - Indicates Cinch std. option.

\*\* - See p. 5-12 for std. hardware dims. See p. 5-13 for non-std. hardware & p. 5-31 for Mil spec. hardware both sold separately.

\*\*\*- Length Tolerance: solid wire =  $\pm 3/32"$ , standard wire =  $\pm 1/4"$ .

**Connector Dimensions - Plastic Shell**

**Plug**



**Socket**



5

| No. of Contacts | A             |       | B Max. |       | C                            |       | D            |       | E            |      | F Max. |      |
|-----------------|---------------|-------|--------|-------|------------------------------|-------|--------------|-------|--------------|------|--------|------|
|                 | ± .010 (.254) |       |        |       | +.010 (.254)<br>-.018 (.457) |       | ±.005 (.127) |       | ±.010 (.254) |      |        |      |
|                 | in            | mm    | in     | mm    | in                           | mm    | in           | mm    | in           | mm   | in     | mm   |
| 9 Plug          | .778          | 19.76 | .292   | 7.42  | .398                         | 10.11 | .565         | 14.35 | .208         | 5.28 | .173   | 4.39 |
| 9 Socket        | .778          | 19.76 | .376   | 9.55  | .398                         | 10.11 | .565         | 14.35 | .208         | 5.28 | .173   | 4.39 |
| 15 Plug         | .928          | 23.57 | .442   | 11.23 | .548                         | 13.92 | .715         | 18.16 | .208         | 5.28 | .173   | 4.39 |
| 15 Socket       | .928          | 23.57 | .526   | 13.36 | .548                         | 13.92 | .715         | 18.16 | .208         | 5.28 | .173   | 4.39 |
| 21 Plug         | 1.078         | 27.38 | .592   | 15.04 | .698                         | 17.73 | .865         | 21.97 | .208         | 5.28 | .173   | 4.39 |
| 21 Socket       | 1.078         | 27.38 | .676   | 17.17 | .698                         | 17.73 | .865         | 21.97 | .208         | 5.28 | .173   | 4.39 |
| 25 Plug         | 1.178         | 29.92 | .692   | 17.58 | .798                         | 20.27 | .965         | 24.51 | .208         | 5.28 | .173   | 4.39 |
| 25 Socket       | 1.178         | 29.92 | .776   | 19.71 | .798                         | 20.27 | .965         | 24.51 | .208         | 5.28 | .173   | 4.39 |
| 31 Plug         | 1.328         | 33.73 | .842   | 21.39 | .948                         | 24.08 | 1.115        | 28.32 | .208         | 5.28 | .173   | 4.39 |
| 31 Socket       | 1.328         | 33.73 | .926   | 23.52 | .948                         | 24.08 | 1.115        | 28.32 | .208         | 5.28 | .173   | 4.39 |
| 37 Plug         | 1.478         | 37.54 | .992   | 25.20 | 1.098                        | 27.89 | 1.265*       | 32.13 | .208         | 5.28 | .173   | 4.39 |
| 37 Socket       | 1.478         | 37.54 | 1.076  | 27.33 | 1.098                        | 27.89 | 1.265*       | 32.13 | .208         | 5.28 | .173   | 4.39 |
| 51 Plug         | 1.428         | 36.27 | .942   | 23.93 | 1.048                        | 26.62 | 1.215        | 30.86 | .250         | 6.35 | .220   | 5.59 |
| 51 Socket       | 1.428         | 36.27 | 1.026  | 26.06 | 1.048                        | 26.62 | 1.215        | 30.86 | .250         | 6.35 | .220   | 5.59 |

**Panel Mounting Dimensions**

Pin and socket,  
rear mounted



Pin and socket,  
front mounted



Pin, front mounted  
Socket, rear mounted



**Panel Cutout Dimensions**



Figure 1. Front Mounting



Figure 2. Rear Mounting



Figure 3. Edgeboard Mounting

| No. of Contacts | Figure Number | A                      |                        | B                      |                        | C                      |                        |
|-----------------|---------------|------------------------|------------------------|------------------------|------------------------|------------------------|------------------------|
|                 |               | +0.004<br>-0.000<br>in | (.101)<br>(.000)<br>mm | +0.004<br>-0.000<br>in | (.101)<br>(.000)<br>mm | +0.005<br>-0.000<br>in | (.127)<br>(.000)<br>mm |
| 9               | 1             | .408                   | 10.36                  | .172                   | 4.37                   | .570                   | 14.48                  |
|                 | 2             | .373                   | 9.47                   | .216                   | 5.49                   | .570                   | 14.48                  |
|                 | 3             | -                      | -                      | -                      | -                      | .570                   | 14.48                  |
| 15              | 1             | .558                   | 14.17                  | .172                   | 4.37                   | .720                   | 18.29                  |
|                 | 2             | .523                   | 13.28                  | .216                   | 5.49                   | .720                   | 18.29                  |
|                 | 3             | -                      | -                      | -                      | -                      | .720                   | 18.29                  |
| 21              | 1             | .708                   | 17.98                  | .172                   | 4.37                   | .870                   | 22.10                  |
|                 | 2             | .674                   | 17.12                  | .216                   | 5.49                   | .870                   | 22.10                  |
|                 | 3             | -                      | -                      | -                      | -                      | .870                   | 22.10                  |
| 25              | 1             | .808                   | 20.52                  | .172                   | 4.37                   | .970                   | 24.64                  |
|                 | 2             | .774                   | 19.66                  | .216                   | 5.49                   | .970                   | 24.64                  |
|                 | 3             | -                      | -                      | -                      | -                      | .970                   | 24.64                  |
| 31              | 1             | .958                   | 24.33                  | .172                   | 4.37                   | 1.120                  | 28.45                  |
|                 | 2             | .924                   | 23.47                  | .216                   | 5.49                   | 1.120                  | 28.45                  |
|                 | 3             | -                      | -                      | -                      | -                      | 1.120                  | 28.45                  |
| 37              | 1             | 1.108                  | 28.14                  | .172                   | 4.37                   | 1.270                  | 32.26                  |
|                 | 2             | 1.074                  | 27.28                  | .216                   | 5.49                   | 1.270                  | 32.26                  |
|                 | 3             | -                      | -                      | -                      | -                      | 1.270                  | 32.26                  |
| 51              | 1             | 1.058                  | 26.87                  | .215                   | 5.46                   | 1.220                  | 30.99                  |
|                 | 2             | 1.024                  | 26.01                  | .259                   | 6.58                   | 1.220                  | 30.99                  |
|                 | 3             | -                      | -                      | -                      | -                      | 1.220                  | 30.99                  |

**Dura-Con**  
**High Reliability**  
**Metal Shell**

.050" (1.27mm) Density  
 Solder Cup/Wire  
 D-Microminiature



FEATURES

- Both plug and socket available in 9, 15, 21, 25, 31, 37, 51, and 100 positions.
- Several styles of mounting are available for cable-to-cable, cable-to-panel mount, and cable-to-board mount.
- Aluminum shell provides extra strength and EMI/RFI shielding capability. Plating options available.
- Silicone elastomer compression interfacial seal protects contacts from moisture and humidity and isolates contacts from each other and the metal shell.
- Meets requirements of MIL-C-83513 except where noted.
- Rugged twist-pin contacts resistant to shock and vibration make metal shell Dura-Con an excellent choice for harsh environments such as airborne or space applications.



MATERIALS

**Insulator:** UL94V-0 rated glass-filled polyester or diallyl phthalate  
**Contacts:** Pins - Copper alloy, Sockets - Copper alloy (machined)  
**Contact Plating:** .000050 in gold  
**Shell:** Aluminum alloy  
**Shell Plating:** Yellow chromate over cadmium (std.) or electroless nickel

ENVIRONMENTAL

**Operating Temperature:** -55°C to +135°C

ELECTRICAL

**Current Rating:** 3 Amps maximum  
**Withstanding Voltage:** 600 VAC RMS @ sea level  
**Contact Resistance:** 8 milliohms maximum

MECHANICAL

**Individual Contact:** 6 oz. (170.40 g) maximum insertion;  
 0.5 oz. (14.20 g) minimum withdrawal  
**Mating / Unmating Force:** See table

| No. of Contacts | Maximum Mating Force |       | Minimum Unmating Force |      |
|-----------------|----------------------|-------|------------------------|------|
|                 | Lb.                  | Kg    | Lb.                    | Kg   |
| 9               | 5.63                 | 2.56  | .28                    | .13  |
| 15              | 9.38                 | 4.26  | .47                    | .21  |
| 21              | 13.13                | 5.96  | .66                    | .30  |
| 25              | 15.63                | 7.10  | .78                    | .35  |
| 31              | 19.38                | 8.80  | .97                    | .44  |
| 37              | 23.13                | 10.50 | 1.16                   | .53  |
| 51              | 31.88                | 14.47 | 1.59                   | .72  |
| 100             | 62.50                | 28.38 | 3.13                   | 1.42 |



**Contact Arrangements**

(Face view of pin insert)  
 (Use reverse order for socket side)



**Ordering Information**



\* - Indicates Cinch std. option.

\*\* - See p. 5-12 for std. hardware dims. See p. 5-13 for non-std. hardware & p. 5-31 for Mil spec. hardware both sold separately.

\*\*\* - Length Tolerance: solid wire = ± 3/32", standard wire = ± 1/4".

**Connector Dimensions - Metal Shell**



| No. of Contacts | A             |       | B Max. |       | C                              |       | D             |       | E             |      | F Max. |      |
|-----------------|---------------|-------|--------|-------|--------------------------------|-------|---------------|-------|---------------|------|--------|------|
|                 | ± .010 (.254) |       |        |       | + .010 (.254)<br>- .018 (.457) |       | ± .005 (.127) |       | ± .010 (.254) |      |        |      |
|                 | in            | mm    | in     | mm    | in                             | mm    | in            | mm    | in            | mm   | in     | mm   |
| 9 Plug          | .775          | 19.68 | .333   | 8.46  | .390                           | 9.91  | .565          | 14.35 | .298          | 7.57 | .270   | 6.86 |
| 9 Socket        | .775          | 19.68 | .396   | 10.06 | .390                           | 9.91  | .565          | 14.35 | .298          | 7.57 | .270   | 6.86 |
| 15 Plug         | .925          | 23.50 | .483   | 12.27 | .540                           | 13.72 | .715          | 18.16 | .298          | 7.57 | .270   | 6.86 |
| 15 Socket       | .925          | 23.50 | .546   | 13.87 | .540                           | 13.72 | .715          | 18.16 | .298          | 7.57 | .270   | 6.86 |
| 21 Plug         | 1.075         | 27.30 | .633   | 16.08 | .690                           | 17.53 | .865          | 21.97 | .298          | 7.57 | .270   | 6.86 |
| 21 Socket       | 1.075         | 27.30 | .696   | 17.68 | .690                           | 17.53 | .865          | 21.97 | .298          | 7.57 | .270   | 6.86 |
| 25 Plug         | 1.175         | 29.84 | .733   | 18.62 | .790                           | 20.07 | .965          | 24.51 | .298          | 7.57 | .270   | 6.86 |
| 25 Socket       | 1.175         | 29.84 | .796   | 20.22 | .790                           | 20.07 | .965          | 24.51 | .298          | 7.57 | .270   | 6.86 |
| 31 Plug         | 1.325         | 33.66 | .883   | 21.16 | .940                           | 23.88 | 1.115         | 28.32 | .298          | 7.57 | .270   | 6.86 |
| 31 Socket       | 1.325         | 33.66 | .946   | 24.03 | .940                           | 23.88 | 1.115         | 28.32 | .298          | 7.57 | .270   | 6.86 |
| 37 Plug         | 1.475         | 37.46 | 1.033  | 26.24 | 1.090                          | 27.69 | 1.265         | 32.13 | .298          | 7.57 | .270   | 6.86 |
| 37 Socket       | 1.475         | 37.46 | 1.096  | 27.84 | 1.090                          | 27.69 | 1.265         | 32.13 | .298          | 7.57 | .270   | 6.86 |
| 51 Plug         | 1.425         | 36.20 | .983   | 24.97 | 1.040                          | 26.42 | 1.215         | 30.86 | .341          | 8.66 | .310   | 7.87 |
| 51 Socket       | 1.425         | 36.20 | 1.046  | 26.57 | 1.040                          | 26.42 | 1.215         | 30.86 | .341          | 8.66 | .310   | 7.87 |
| 100 Plug        | 2.160         | 54.86 | 1.383  | 35.13 | 1.432                          | 36.38 | 1.800         | 45.71 | .384          | 9.75 | .360   | 9.15 |
| 100 Socket      | 2.160         | 54.86 | 1.446  | 36.73 | 1.432                          | 36.38 | 1.800         | 45.71 | .384          | 9.75 | .360   | 9.15 |

**Panel Mounting Dimensions**

Pin and socket,  
rear mounted



Pin and socket,  
front mounted



Pin, front mounted  
Socket, rear mounted



**Panel Cutout Dimensions**



| No. of Contacts | Figure Number | A                      |                        | B                      |                        | C                      |                        | D                      |                        |
|-----------------|---------------|------------------------|------------------------|------------------------|------------------------|------------------------|------------------------|------------------------|------------------------|
|                 |               | +0.004<br>-0.000<br>in | (.101)<br>(.000)<br>mm | +0.004<br>-0.000<br>in | (.101)<br>(.000)<br>mm | +0.005<br>-0.000<br>in | (.127)<br>(.000)<br>mm | +0.005<br>-0.000<br>in | (1.27)<br>(.000)<br>mm |
| 9               | 1             | .408                   | 10.36                  | .270                   | 6.86                   | .570                   | 14.48                  | -                      | -                      |
|                 | 2             | .408                   | 10.36                  | .256                   | 6.50                   | .570                   | 14.48                  | .089                   | 2.26                   |
|                 | 3             | -                      | -                      | -                      | -                      | .570                   | 14.48                  | -                      | -                      |
| 15              | 1             | .558                   | 14.17                  | .270                   | 6.86                   | .720                   | 18.29                  | -                      | -                      |
|                 | 2             | .558                   | 14.17                  | .256                   | 6.50                   | .720                   | 18.29                  | .089                   | 2.26                   |
|                 | 3             | -                      | -                      | -                      | -                      | .720                   | 18.29                  | -                      | -                      |
| 21              | 1             | .708                   | 17.98                  | .270                   | 6.86                   | .870                   | 22.10                  | -                      | -                      |
|                 | 2             | .708                   | 17.98                  | .256                   | 6.50                   | .870                   | 22.10                  | .089                   | 2.26                   |
|                 | 3             | -                      | -                      | -                      | -                      | .870                   | 22.10                  | -                      | -                      |
| 25              | 1             | .808                   | 20.52                  | .270                   | 6.86                   | .970                   | 24.64                  | -                      | -                      |
|                 | 2             | .808                   | 20.52                  | .256                   | 6.50                   | .970                   | 24.64                  | .089                   | 2.26                   |
|                 | 3             | -                      | -                      | -                      | -                      | .970                   | 24.64                  | -                      | -                      |
| 31              | 1             | .958                   | 24.33                  | .270                   | 6.86                   | 1.120                  | 28.45                  | -                      | -                      |
|                 | 2             | .958                   | 24.33                  | .256                   | 6.50                   | 1.120                  | 28.45                  | .089                   | 2.26                   |
|                 | 3             | -                      | -                      | -                      | -                      | 1.120                  | 28.45                  | -                      | -                      |
| 37              | 1             | 1.108                  | 28.14                  | .270                   | 6.86                   | 1.270                  | 32.26                  | -                      | -                      |
|                 | 2             | 1.108                  | 28.14                  | .256                   | 6.50                   | 1.270                  | 32.26                  | .089                   | 2.26                   |
|                 | 3             | -                      | -                      | -                      | -                      | 1.270                  | 32.26                  | -                      | -                      |
| 51              | 1             | 1.058                  | 26.87                  | .315                   | 8.00                   | 1.220                  | 30.99                  | -                      | -                      |
|                 | 2             | 1.058                  | 26.87                  | .300                   | 7.62                   | 1.220                  | 30.99                  | .089                   | 2.26                   |
|                 | 3             | -                      | -                      | -                      | -                      | 1.220                  | 30.99                  | -                      | -                      |
| 100             | 1             | 1.450                  | 36.84                  | .361                   | 9.17                   | 1.805                  | 45.86                  | .117                   | 2.97                   |
|                 | 2             | 1.562                  | 39.68                  | .338                   | 8.58                   | 1.805                  | 45.86                  | .117                   | 2.97                   |
|                 | 3             | -                      | -                      | -                      | -                      | 1.805                  | 45.86                  | .117                   | 2.97                   |

**Mounting Hardware**  
**For Plastic & Metal Shell**  
**Dura-Con Connectors**



**Float Mounting**  
**Option "F"**



**Reversed Float Mounting**  
**Option "R"**



**Standard Jackscrew**  
**Option "K"**



**Low Profile Jackscrew**  
**Option "L"**



**Removable Jackpost**  
**Option "P"**



Screwlock Kit

**P/N: DCSL1**  
**Purchased Separately**

**Jackpost - Rear Panel Mount**  
 (Purchased Separately)

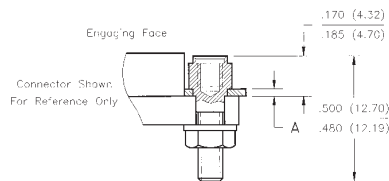

Jackpost Bushing  
 (for rear panel mounting)

| Jackpost Part Number | Panel Thickness |     | A Dimension |           |
|----------------------|-----------------|-----|-------------|-----------|
|                      | in              | mm  | in          | mm        |
| DCJPRM094            | .094            | 2.5 | .092/.087   | 2.34/2.21 |
| DCJPRM063            | .063            | 1.6 | .061/.056   | 1.55/1.42 |
| DCJPRM047            | .047            | 1.2 | .047/.042   | 1.19/1.07 |
| DCJPRM031            | .031            | 0.8 | .030/.025   | 0.76/0.64 |

**Panel Cutout Dimensions**  
 (Plug & Receptacle)



| Part Number<br>(by Shell Size) | A                            |       | B                            |      | C            |       |
|--------------------------------|------------------------------|-------|------------------------------|------|--------------|-------|
|                                | +.004 (.101)<br>-.000 (.000) |       | +.004 (.101)<br>-.000 (.000) |      | ±.005 (.127) |       |
|                                | in                           | mm    | in                           | mm   | in           | mm    |
| 9                              | .398                         | 10.11 | .249                         | 6.32 | .565         | 14.35 |
| 15                             | .548                         | 13.92 | .249                         | 6.32 | .715         | 18.16 |
| 21                             | .698                         | 17.73 | .249                         | 6.32 | .865         | 21.97 |
| 25                             | .798                         | 20.27 | .249                         | 6.32 | .965         | 24.51 |
| 31                             | .948                         | 24.08 | .249                         | 6.32 | 1.115        | 28.34 |
| 37                             | 1.098                        | 27.89 | .249                         | 6.32 | 1.265        | 32.13 |
| 51                             | 1.048                        | 26.62 | .292                         | 7.42 | 1.215        | 30.86 |
| 100                            | 1.448                        | 36.78 | .336                         | 8.53 | 1.800        | 45.72 |

# Dura-Con High Reliability Metal Shell

.050" (1.27mm) Density  
PCB Mount Terminal Block



## FEATURES

- Plug & socket versions available in 9, 15, 21, 25, 31, 37, 51, and 100 positions.
- Flow-through design facilitates inspection and cleaning after soldering.
- All terminal block connectors use standard mounting hardware.
- Metal shell provides EMI/RFI shielding capability.
- Available in 3 styles: Straight mount, 90° right-angle mount, and 90° right-angle narrow profile mounting.
- Silicone elastomer interfacial seal protects contacts from moisture and isolates them from each other and from the metal shell.
- Meets requirements of MIL-C-83513.
- Choice of insulator materials.



## MATERIALS

**Insulator:** UL94V-0 glass-filled polyester or diallyl phthalate  
**Contacts:** Pins - Copper alloy, Sockets - Copper alloy (machined)  
**Contact Plating:** .000050 in gold  
**Shell:** Aluminum alloy  
**Shell Plating:** Yellow chromate over cadmium (std.) or electroless nickel

## ENVIRONMENTAL

**Operating Temperature:** -55°C to +135°C

## ELECTRICAL

**Current Rating:** 3 Amps maximum  
**Withstanding Voltage:** 600 VAC RMS @ sea level, 150 VAC @ 70,000 ft.  
**Contact Resistance:** 8 milliohms maximum  
**Insulation Resistance:** 1,000 megohms min between adjacent pins

## MECHANICAL

**Individual Contact:** 6 oz. (170.40 g) maximum insertion force;  
 0.5 oz. (14.20 g) minimum withdrawal force  
**Mating / Unmating Forces:** See table

| No. of<br>Contacts | Maximum<br>Mating Force |       | Minimum<br>Unmating Force |      |
|--------------------|-------------------------|-------|---------------------------|------|
|                    | Lb.                     | Kg    | Lb.                       | Kg   |
| 9                  | 5.63                    | 2.56  | .28                       | .13  |
| 15                 | 9.38                    | 4.26  | .47                       | .21  |
| 21                 | 13.13                   | 5.96  | .66                       | .30  |
| 25                 | 15.63                   | 7.10  | .78                       | .35  |
| 31                 | 19.38                   | 8.80  | .97                       | .44  |
| 37                 | 23.13                   | 10.50 | 1.16                      | .53  |
| 51                 | 31.88                   | 14.47 | 1.59                      | .72  |
| 100                | 62.50                   | 28.38 | 3.13                      | 1.42 |

# Dura-Con High Reliability Metal Shell

.050" (1.27mm) Density  
PCB Mount Terminal Block



## Contact Arrangements



## Ordering Information



\* For other options consult factory.

**90° Termination**



**Recommended Board Layout**



NOTE: For additional connector dimensions, see page 5-10.

| No. of Contacts | A     |       | B     |       | C     |       | F    |       |
|-----------------|-------|-------|-------|-------|-------|-------|------|-------|
|                 | in    | mm    | in    | mm    | in    | mm    | in   | mm    |
| 9 Plug          | 1.390 | 35.31 | 1.150 | 29.21 | .565  | 14.35 | .465 | 11.81 |
| 9 Socket        | 1.390 | 35.31 | 1.150 | 29.21 | .565  | 14.35 | .465 | 11.81 |
| 15 Plug         | 1.540 | 39.12 | 1.300 | 33.02 | .715  | 18.16 | .465 | 11.81 |
| 15 Socket       | 1.540 | 39.12 | 1.300 | 33.02 | .715  | 18.16 | .465 | 11.81 |
| 21 Plug         | 1.690 | 42.93 | 1.450 | 36.83 | .865  | 21.97 | .465 | 11.81 |
| 21 Socket       | 1.690 | 42.93 | 1.450 | 36.83 | .865  | 21.97 | .465 | 11.81 |
| 25 Plug         | 1.790 | 45.47 | 1.550 | 39.37 | .965  | 24.51 | .465 | 11.81 |
| 25 Socket       | 1.790 | 45.47 | 1.550 | 39.37 | .965  | 24.51 | .465 | 11.81 |
| 31 Plug         | 2.040 | 51.82 | 1.800 | 45.72 | 1.115 | 28.32 | .465 | 11.81 |
| 31 Socket       | 2.040 | 51.82 | 1.800 | 45.72 | 1.115 | 28.32 | .465 | 11.81 |
| 37 Plug         | 2.340 | 59.44 | 2.100 | 53.34 | 1.265 | 32.13 | .465 | 11.81 |
| 37 Socket       | 2.340 | 59.44 | 2.100 | 53.34 | 1.265 | 32.13 | .465 | 11.81 |
| 51 Plug         | 1.875 | 47.63 | 1.600 | 40.64 | 1.215 | 30.86 | .565 | 14.35 |
| 51 Socket       | 1.875 | 47.63 | 1.600 | 40.64 | 1.215 | 30.86 | .565 | 14.35 |
| 100 Plug        | 2.780 | 70.61 | 2.500 | 63.50 | 1.800 | 45.72 | .765 | 19.43 |
| 100 Socket      | 2.780 | 70.61 | 2.500 | 63.50 | 1.800 | 45.72 | .765 | 19.43 |

| No. of Contacts | G    |       | H    |      | J    |      | K    |      |
|-----------------|------|-------|------|------|------|------|------|------|
|                 | in   | mm    | in   | mm   | in   | mm   | in   | mm   |
| 9 Plug          | .308 | 7.82  | .190 | 4.83 | .096 | 2.44 | .125 | 3.18 |
| 9 Socket        | .308 | 7.82  | .200 | 5.08 | .096 | 2.44 | .125 | 3.18 |
| 15 Plug         | .308 | 7.82  | .190 | 4.83 | .096 | 2.44 | .125 | 3.18 |
| 15 Socket       | .308 | 7.82  | .200 | 5.08 | .096 | 2.44 | .125 | 3.18 |
| 21 Plug         | .308 | 7.82  | .190 | 4.83 | .096 | 2.44 | .125 | 3.18 |
| 21 Socket       | .308 | 7.82  | .200 | 5.08 | .096 | 2.44 | .125 | 3.18 |
| 25 Plug         | .308 | 7.82  | .190 | 4.83 | .096 | 2.44 | .125 | 3.18 |
| 25 Socket       | .308 | 7.82  | .200 | 5.08 | .096 | 2.44 | .125 | 3.18 |
| 31 Plug         | .308 | 7.82  | .190 | 4.83 | .096 | 2.44 | .125 | 3.18 |
| 31 Socket       | .308 | 7.82  | .200 | 5.08 | .096 | 2.44 | .125 | 3.18 |
| 37 Plug         | .308 | 7.82  | .190 | 4.83 | .096 | 2.44 | .125 | 3.18 |
| 37 Socket       | .308 | 7.82  | .200 | 5.08 | .096 | 2.44 | .125 | 3.18 |
| 51 Plug         | .351 | 8.92  | .190 | 4.83 | .096 | 2.44 | .125 | 3.18 |
| 51 Socket       | .351 | 8.92  | .200 | 5.08 | .096 | 2.44 | .125 | 3.18 |
| 100 Plug        | .394 | 10.00 | .190 | 4.83 | .125 | 3.18 | .225 | 5.72 |
| 100 Socket      | .394 | 10.00 | .200 | 5.08 | .125 | 3.18 | .225 | 5.72 |



# Dura-Con High Reliability Metal Shell

.050" (1.27mm) Density  
PCB Mount Terminal Block



## Straight (180°) Termination



## Recommended Board Layout

(As Viewed from Bottom  
of Terminal Block)



Typ. Hole Dia. = .040" (1.02 mm)

NOTE: For additional connector dimensions, see page 5-10.

| No. of<br>Contacts | A<br>Max. |       | B<br>± .007 (0.18) |       | C<br>± .005 (0.13) |       | D<br>Max. |       | G<br>Max. |       |
|--------------------|-----------|-------|--------------------|-------|--------------------|-------|-----------|-------|-----------|-------|
|                    | in        | mm    | in                 | mm    | in                 | mm    | in        | mm    | in        | mm    |
| 9 Plug             | 1.390     | 35.31 | 1.150              | 29.21 | .565               | 14.35 | .885      | 22.48 | .308      | 7.75  |
| 9 Socket           | 1.390     | 35.31 | 1.150              | 29.21 | .565               | 14.35 | .885      | 22.48 | .308      | 7.75  |
| 15 Plug            | 1.390     | 35.31 | 1.150              | 29.21 | .715               | 18.16 | .945      | 24.0  | .308      | 7.75  |
| 15 Socket          | 1.390     | 35.31 | 1.150              | 29.21 | .715               | 18.16 | .945      | 24.0  | .308      | 7.75  |
| 21 Plug            | 1.690     | 42.93 | 1.450              | 36.83 | .865               | 21.97 | 1.185     | 30.09 | .308      | 7.75  |
| 21 Socket          | 1.690     | 42.93 | 1.450              | 36.83 | .865               | 21.97 | 1.185     | 30.09 | .308      | 7.75  |
| 25 Plug            | 1.740     | 44.20 | 1.500              | 38.10 | .965               | 24.51 | 1.275     | 32.38 | .308      | 7.75  |
| 25 Socket          | 1.740     | 44.20 | 1.500              | 38.10 | .965               | 24.51 | 1.275     | 32.38 | .308      | 7.75  |
| 31 Plug            | 2.040     | 51.82 | 1.800              | 45.72 | 1.115              | 28.32 | 1.575     | 40.00 | .308      | 7.75  |
| 31 Socket          | 2.040     | 51.82 | 1.800              | 45.72 | 1.115              | 28.32 | 1.575     | 40.00 | .308      | 7.75  |
| 37 Plug            | 2.340     | 59.44 | 2.100              | 53.34 | 1.265              | 32.13 | 1.875     | 47.62 | .308      | 7.75  |
| 37 Socket          | 2.340     | 59.44 | 2.100              | 53.34 | 1.265              | 32.13 | 1.875     | 47.62 | .308      | 7.75  |
| 51 Plug            | 2.270     | 57.66 | 2.000              | 50.80 | 1.215              | 30.86 | 1.775     | 45.08 | .351      | 8.92  |
| 51 Socket          | 2.270     | 57.66 | 2.000              | 50.80 | 1.215              | 30.86 | 1.775     | 45.08 | .351      | 8.92  |
| 100 Plug           | 3.070     | 77.98 | 2.800              | 71.12 | 1.800              | 45.72 | 2.585     | 65.55 | .455      | 11.56 |
| 100 Socket         | 3.070     | 77.98 | 2.800              | 71.12 | 1.800              | 45.72 | 2.585     | 65.55 | .455      | 11.56 |

| No. of<br>Contacts | H<br>Max. |      | J<br>± .005 (0.13) |      | K<br>Max. |      | L<br>Max. |       |
|--------------------|-----------|------|--------------------|------|-----------|------|-----------|-------|
|                    | in        | mm   | in                 | mm   | in        | mm   | in        | mm    |
| 9 Plug             | .190      | 4.83 | .096               | 2.44 | .165      | 4.19 | .355      | 9.02  |
| 9 Socket           | .200      | 5.08 | .096               | 2.44 | .165      | 4.19 | .355      | 9.02  |
| 15 Plug            | .190      | 4.83 | .096               | 2.44 | .165      | 4.19 | .355      | 9.02  |
| 15 Socket          | .200      | 5.08 | .096               | 2.44 | .165      | 4.19 | .355      | 9.02  |
| 21 Plug            | .190      | 4.83 | .096               | 2.44 | .165      | 4.19 | .355      | 9.02  |
| 21 Socket          | .200      | 5.08 | .096               | 2.44 | .165      | 4.19 | .355      | 9.02  |
| 25 Plug            | .190      | 4.83 | .096               | 2.44 | .165      | 4.19 | .355      | 9.02  |
| 25 Socket          | .200      | 5.08 | .096               | 2.44 | .165      | 4.19 | .355      | 9.02  |
| 31 Plug            | .190      | 4.83 | .096               | 2.44 | .165      | 4.19 | .355      | 9.02  |
| 31 Socket          | .200      | 5.08 | .096               | 2.44 | .165      | 4.19 | .355      | 9.02  |
| 37 Plug            | .190      | 4.83 | .096               | 2.44 | .165      | 4.19 | .355      | 9.02  |
| 37 Socket          | .200      | 5.08 | .096               | 2.44 | .165      | 4.19 | .355      | 9.02  |
| 51 Plug            | .190      | 4.83 | .096               | 2.44 | .165      | 4.19 | .355      | 9.02  |
| 51 Socket          | .200      | 5.08 | .096               | 2.44 | .165      | 4.19 | .355      | 9.02  |
| 100 Plug           | .190      | 4.83 | .125               | 3.18 | .300      | 7.62 | .550      | 13.97 |
| 100 Socket         | .200      | 5.08 | .125               | 3.18 | .300      | 7.62 | .550      | 13.97 |

**90° Narrow Termination**



**Recommended Board Layout**

(As Viewed from Bottom of Terminal Block)



NOTE: For additional connector dimensions, see page 5-10.

Typ. Hole Dia. = .040" (1.02 mm)

| No. of Contacts | A     |       | B     |       | C    |       |
|-----------------|-------|-------|-------|-------|------|-------|
|                 | in    | mm    | in    | mm    | in   | mm    |
| 9 Plug          | .785  | 19.94 | .565  | 14.35 | .308 | 7.82  |
| 9 Socket        | .785  | 19.94 | .565  | 14.35 | .308 | 7.82  |
| 15 Plug         | .935  | 23.75 | .715  | 18.16 | .308 | 7.82  |
| 15 Socket       | .935  | 23.75 | .715  | 18.16 | .308 | 7.82  |
| 21 Plug         | 1.085 | 27.56 | .865  | 21.97 | .308 | 7.82  |
| 21 Socket       | 1.085 | 27.56 | .865  | 21.97 | .308 | 7.82  |
| 25 Plug         | 1.085 | 30.10 | .965  | 24.51 | .308 | 7.82  |
| 25 Socket       | 1.185 | 30.10 | .965  | 24.51 | .308 | 7.82  |
| 31 Plug         | 1.335 | 33.91 | 1.115 | 28.32 | .308 | 7.82  |
| 31 Socket       | 1.335 | 33.91 | 1.115 | 28.32 | .308 | 7.82  |
| 37 Plug         | 1.485 | 37.72 | 1.265 | 32.13 | .308 | 7.82  |
| 37 Socket       | 1.485 | 37.72 | 1.265 | 32.13 | .308 | 7.82  |
| 51 Plug         | 1.435 | 36.45 | 1.215 | 30.86 | .351 | 8.92  |
| 51 Socket       | 1.435 | 36.45 | 1.215 | 30.86 | .351 | 8.92  |
| 100 Plug        | 2.175 | 55.25 | 1.800 | 45.72 | .394 | 10.00 |
| 100 Socket      | 2.175 | 55.25 | 1.800 | 45.72 | .394 | 10.00 |

| No. of Contacts | F    |      | G    |       | H     |       | J    |      |
|-----------------|------|------|------|-------|-------|-------|------|------|
|                 | in   | mm   | in   | mm    | in    | mm    | in   | mm   |
| 9 Plug          | .230 | 5.84 | .250 | 6.35  | .420  | 10.67 | .096 | 2.44 |
| 9 Socket        | .230 | 5.84 | .250 | 6.35  | .420  | 10.67 | .096 | 2.44 |
| 15 Plug         | .130 | 3.30 | .250 | 6.35  | .420  | 10.67 | .096 | 2.44 |
| 15 Socket       | .130 | 3.30 | .250 | 6.35  | .420  | 10.67 | .096 | 2.44 |
| 21 Plug         | .130 | 3.30 | .250 | 6.35  | .420  | 10.67 | .096 | 2.44 |
| 21 Socket       | .130 | 3.30 | .250 | 6.35  | .420  | 10.67 | .096 | 2.44 |
| 25 Plug         | .130 | 3.30 | .250 | 6.35  | .420  | 10.67 | .096 | 2.44 |
| 25 Socket       | .130 | 3.30 | .250 | 6.35  | .420  | 10.67 | .096 | 2.44 |
| 31 Plug         | .130 | 3.30 | .250 | 6.35  | .520  | 13.21 | .996 | 2.44 |
| 31 Socket       | .130 | 3.30 | .250 | 6.35  | .520  | 13.21 | .096 | 2.44 |
| 37 Plug         | .130 | 3.30 | .250 | 6.35  | .520  | 13.21 | .096 | 2.44 |
| 37 Socket       | .130 | 3.30 | .250 | 6.35  | .520  | 13.21 | .096 | 2.44 |
| 51 Plug         | .150 | 3.81 | .300 | 7.62  | .650  | 16.51 | .096 | 2.44 |
| 51 Socket       | .150 | 3.81 | .300 | 7.62  | .650  | 16.51 | .096 | 2.44 |
| 100 Plug        | .200 | 5.08 | .400 | 10.16 | 1.000 | 25.40 | .125 | 3.18 |
| 100 Socket      | .200 | 5.08 | .400 | 10.16 | 1.000 | 25.40 | .125 | 3.18 |

**Dura-Con**  
**High Reliability**  
**MIL-C-83513**

.050" (1.27mm) Density  
 Solder Cup/Wire  
 D-Microminiature



FEATURES

- All-plastic and metal shell wire versions available in solder cup, gold-plated solid wire, and insulated stranded wire.
- PCB mount "terminal block" type connectors available in straight or right angle.
- Sizes offered - 9, 15, 21, 25, 31, 35, 51, and 100 (metal shell only).
- All products are qualified to the requirements of MIL-C-83513 and marked with the M83513 part number.
- Optional shell platings and insulator materials offer high performance in harsh environments.
- Mounting hardware per MIL-C-83513.



MATERIALS

**Insulator:** UL94V-0 rated glass-filled polyester per MIL-M-24519 or diallyl phthalate (DAP) per MIL-M-14.  
**Contacts:** Pins - Copper alloy, Sockets - Copper alloy  
**Contact Plating:** .000050 in gold per MIL-G-45204  
**Shell Material (Metal Shell Only):** Aluminum alloy  
**Shell Plating (Metal Shell Only):** Yellow chromate over cadmium (std.) or electroless nickel

ENVIRONMENTAL

**Operating Temperature:** -55°C to +125°C

ELECTRICAL

**Current Rating:** 3 Amps maximum  
**Withstanding Voltage:** 600 VAC RMS @ sea level  
**Contact Resistance:** 8 milliohms maximum

MECHANICAL

**Durability:** 500 mate/unmate cycles  
**Individual Contact:** Forces 6 oz. (170.40 g) maximum insertion;  
 0.5 oz. (14.20 g) minimum withdrawal  
**Mating / Unmating Force:** See table

| No. of Contacts | Maximum Mating Force |       | Minimum Unmating Force |     |
|-----------------|----------------------|-------|------------------------|-----|
|                 | Lb.                  | Kg    | Lb.                    | Kg  |
| 9               | 5.63                 | 2.56  | .28                    | .13 |
| 15              | 9.38                 | 4.26  | .47                    | .21 |
| 21              | 13.13                | 5.96  | .66                    | .30 |
| 25              | 15.63                | 7.10  | .78                    | .35 |
| 31              | 19.38                | 8.80  | .97                    | .44 |
| 37              | 23.13                | 10.50 | 1.16                   | .53 |
| 51              | 31.88                | 14.47 | 1.59                   | .72 |

**Metal Shell**

**Contact Arrangements**

(Face view of pin insert)

(Use reverse order for socket side)



**Ordering Information**

**M83513/04 - A 03 C**

**Connector Type**

- 01 - Metal Shell D Plugs with Solder Cup Termination
- 02 - Metal Shell D Sockets with Solder Cup Termination
- 03 - Metal Shell D Plugs with Wire Leads
- 04 - Metal Shell D Sockets with Wire Leads

**Insert Arrangements**

(No. of Contacts)

- A = 9
- B = 15
- C = 21
- D = 25
- E = 31
- F = 37
- G = 51
- H = 100

**Shell Finish**

- C = Cadmium
- N = Electroless Nickel

**Wire Type (Use only for /03 & /04, otherwise omit)**

- 01 - M22759/11-26-9, 18 inches, White (see note below)
- 02 - M22759/11-26-9, 36 inches, White (see note below)
- 03 - M22759/11-26-(-), 18 inches, Color Coded (see note below)
- 04 - M22759/11-26-(-), 36 inches, Color Coded (see note below)
- 05 - QQ-W-343, 25 AWG, 0.5 inch, Gold-Plated
- 06 - QQ-W-343, 25 AWG, 1.0 inch, Gold-Plated
- 07 - QQ-W-343, 25 AWG, 0.5 inch, Tin-Plated
- 08 - QQ-W-343, 25 AWG, 1.0 inch, Tin-Plated
- 09 - M22759/33-26-9, 18 inches, White
- 10 - M22759/33-26-9, 36 inches, White
- 11 - M22759/33-26-(-), 18 inches, Color Coded
- 12 - M22759/33-26-(-), 36 inches, Color Coded
- 13 - M22759/11-26-9, 72 inches, White
- 14 - M22759/11-26-(-), 72 inches, Color Coded
- 15 - M22759/33-26-9, 72 inches, White
- 16 - M22759/33-26-(-), 72 inches, Color Coded

Note: See page 5-31 for M83513 mounting hardware.

**Connector Dimensions - Metal Shell**



| No. of Contacts | A              |       | B Max. (Plug)<br>Min. (Socket) |       | C<br>+ .010" (.254)<br>- .018" (.457) |       | D              |       | E              |      | F Max. |      |
|-----------------|----------------|-------|--------------------------------|-------|---------------------------------------|-------|----------------|-------|----------------|------|--------|------|
|                 | ± .010" (.254) |       |                                |       |                                       |       | ± .005" (.127) |       | ± .010" (.254) |      |        |      |
|                 | in             | mm    | in                             | mm    | in                                    | mm    | in             | mm    | in             | mm   | in     | mm   |
| 9 Plug          | .775           | 19.68 | .3338                          | 8.48  | .390                                  | 9.91  | .565           | 14.35 | .298           | 7.57 | .270   | 6.68 |
| 9 Socket        | .775           | 19.68 | .3342                          | 8.49  | .390                                  | 9.91  | .565           | 14.35 | .298           | 7.57 | .270   | 6.68 |
| 15 Plug         | .925           | 23.50 | .4838                          | 12.29 | .540                                  | 13.72 | .715           | 18.16 | .298           | 7.57 | .270   | 6.68 |
| 15 Socket       | .925           | 23.50 | .4842                          | 12.30 | .540                                  | 13.72 | .715           | 18.16 | .298           | 7.57 | .270   | 6.68 |
| 21 Plug         | 1.075          | 27.30 | .6338                          | 16.10 | .690                                  | 17.53 | .865           | 21.97 | .298           | 7.57 | .270   | 6.68 |
| 21 Socket       | 1.075          | 27.30 | .6342                          | 16.11 | .690                                  | 17.53 | .865           | 21.97 | .298           | 7.57 | .270   | 6.68 |
| 25 Plug         | 1.175          | 29.84 | .7338                          | 18.64 | .790                                  | 20.07 | .965           | 24.51 | .298           | 7.57 | .270   | 6.68 |
| 25 Socket       | 1.175          | 29.84 | .7342                          | 18.65 | .790                                  | 20.07 | .965           | 24.51 | .298           | 7.57 | .270   | 6.68 |
| 31 Plug         | 1.325          | 33.66 | .8838                          | 22.45 | .940                                  | 23.88 | 1.115          | 28.32 | .298           | 7.57 | .270   | 6.68 |
| 31 Socket       | 1.325          | 33.66 | .8842                          | 22.46 | .940                                  | 23.88 | 1.115          | 28.32 | .298           | 7.57 | .270   | 6.68 |
| 37 Plug         | 1.475          | 37.46 | 1.0338                         | 26.26 | 1.090                                 | 27.69 | 1.265          | 32.13 | .298           | 7.57 | .270   | 6.68 |
| 37 Socket       | 1.475          | 37.46 | 1.0342                         | 26.27 | 1.090                                 | 27.69 | 1.265          | 32.13 | .298           | 7.57 | .270   | 6.68 |
| 51 Plug         | 1.425          | 36.20 | .9838                          | 24.99 | 1.040                                 | 26.42 | 1.215          | 30.86 | .341           | 8.66 | .310   | 7.87 |
| 51 Socket       | 1.425          | 36.20 | .9842                          | 25.00 | 1.040                                 | 26.42 | 1.215          | 30.86 | .341           | 8.66 | .310   | 7.87 |
| 100 Plug        | 2.160          | 54.86 | 1.3838                         | 35.15 | 1.432                                 | 36.38 | 1.800          | 45.71 | .384           | 9.75 | .360   | 9.15 |
| 100 Socket      | 2.160          | 54.86 | 1.3842                         | 35.16 | 1.432                                 | 36.38 | 1.800          | 45.71 | .384           | 9.75 | .360   | 9.15 |

**Panel Mounting Dimensions - Metal Shell**

**Panel Mounting Dimensions**

Pin and socket, rear mounted



Pin and socket, front mounted



Pin, front mounted  
 Socket, rear mounted

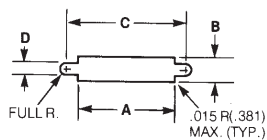
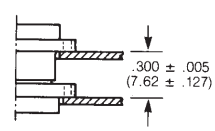

**Front Mounting**

**Panel Cutout Dimensions - Metal Shell**

| No. of Contacts | A               |       | B               |      | C               |       | D               |      |
|-----------------|-----------------|-------|-----------------|------|-----------------|-------|-----------------|------|
|                 | +.004" (.101mm) |       | +.004" (.101mm) |      | +.005" (.127mm) |       | +.005" (.127mm) |      |
|                 | -.000" (.000mm) |       | -.000" (.000mm) |      | -.000" (.000mm) |       | -.000" (.000mm) |      |
|                 | in              | mm    | in              | mm   | in              | mm    | in              | mm   |
| 9               | .408            | 10.36 | .270            | 6.86 | .570            | 14.48 | .089            | 2.26 |
| 15              | .558            | 14.17 | .270            | 6.86 | .720            | 18.29 | .089            | 2.26 |
| 21              | .708            | 17.98 | .270            | 6.86 | .870            | 22.10 | .089            | 2.26 |
| 25              | .808            | 20.52 | .270            | 6.86 | .970            | 24.64 | .089            | 2.26 |
| 31              | .958            | 24.33 | .270            | 6.86 | 1.120           | 28.45 | .089            | 2.26 |
| 37              | 1.108           | 28.14 | .270            | 6.86 | 1.270           | 32.26 | .089            | 2.26 |
| 51              | 1.058           | 26.87 | .315            | 8.00 | 1.220           | 30.99 | .089            | 2.26 |
| 100             | 1.450           | 36.84 | .361            | 9.17 | 1.805           | 45.86 | .117            | 2.97 |

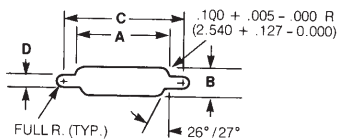

**Rear Mounting**

| No. of Contacts | A               |       | B               |      | C               |       | D               |      |
|-----------------|-----------------|-------|-----------------|------|-----------------|-------|-----------------|------|
|                 | +.004" (.101mm) |       | +.004" (.101mm) |      | +.005" (.127mm) |       | +.005" (.127mm) |      |
|                 | -.000" (.000mm) |       | -.000" (.000mm) |      | -.000" (.000mm) |       | -.000" (.000mm) |      |
|                 | in              | mm    | in              | mm   | in              | mm    | in              | mm   |
| 9               | .408            | 10.36 | .256            | 6.50 | .570            | 14.48 | .089            | 2.26 |
| 15              | .558            | 14.17 | .256            | 6.50 | .720            | 18.29 | .089            | 2.26 |
| 21              | .708            | 17.98 | .256            | 6.50 | .870            | 22.10 | .089            | 2.26 |
| 25              | .808            | 20.52 | .256            | 6.50 | .970            | 24.64 | .089            | 2.26 |
| 31              | .958            | 24.33 | .256            | 6.50 | 1.120           | 28.45 | .089            | 2.26 |
| 37              | 1.108           | 28.14 | .256            | 6.50 | 1.270           | 32.26 | .089            | 2.26 |
| 51              | 1.058           | 26.87 | .300            | 7.62 | 1.220           | 30.99 | .089            | 2.26 |
| 100             | 1.450           | 36.84 | .338            | 8.58 | 1.805           | 45.86 | .117            | 2.97 |

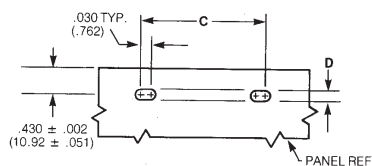

**Edgeboard Mounting**

| No. of Contacts | C               |       | D               |      |
|-----------------|-----------------|-------|-----------------|------|
|                 | +.005" (.127mm) |       | +.005" (.127mm) |      |
|                 | -.000" (.000mm) |       | -.000" (.000mm) |      |
|                 | in              | mm    | in              | mm   |
| 9               | .570            | 14.48 | .089            | 2.26 |
| 15              | .720            | 18.29 | .089            | 2.26 |
| 21              | .870            | 22.10 | .089            | 2.26 |
| 25              | .970            | 24.64 | .089            | 2.26 |
| 31              | 1.120           | 28.45 | .089            | 2.26 |
| 37              | 1.270           | 32.26 | .089            | 2.26 |
| 51              | 1.220           | 30.99 | .089            | 2.26 |
| 100             | 1.805           | 45.86 | .117            | 2.97 |

**Plastic Shell**

**Contact Arrangements**  
 (Face view of pin insert)  
 (Use reverse order for socket side)



**Ordering Information**

**M83513/06-A 04**

**Connector Type**

- 06** - Plastic Shell Plugs with Solder Cup Termination
- 07** - Plastic Shell Sockets with Solder Cup Termination
- 08** - Plastic Shell Plugs with Wire Leads
- 09** - Plastic Shell Sockets with Wire Leads

**Insert Arrangements**

(No. of Contacts)

- A** = 9
- B** = 15
- C** = 21
- D** = 25
- E** = 31
- F** = 37
- G** = 51

**Wire Type (Use only for /08 & /09, otherwise omit)**

- 01** - M22759/11-26-9, 18 inches, White
- 02** - M22759/11-26-9, 36 inches, White
- 03** - M22759/11-26-( ), 18 inches, Color Coded
- 04** - M22759/11-26-( ), 36 inches, Color Coded
- 05** - QQ-W-343, 25 AWG, 0.5 inch, Gold-Plated
- 06** - QQ-W-343, 25 AWG, 1.0 inch, Gold-Plated
- 07** - QQ-W-343, 25 AWG, 0.5 inch, Tin-Plated
- 08** - QQ-W-343, 25 AWG, 1.0 inch, Tin-Plated
- 09** - M22759/33-26-9, 18 inches, White
- 10** - M22759/33-26-9, 36 inches, White
- 11** - M22759/33-26-( ), 18 inches, Color Coded
- 12** - M22759/33-26-( ), 36 inches, Color Coded
- 13** - M22759/11-26-9, 72 inches, White
- 14** - M22759/11-26-( ), 72 inches, Color Coded
- 15** - M22759/33-26-9, 72 inches, White
- 16** - M22759/33-26-( ), 72 inches, Color Coded

Note: See page 5-31 for M83513 mounting hardware.

**Shell Dimensions - (All-Plastic Version)**

**Plug**



**Socket**



| No. of Contacts | A             |       | B Max. (Plug)<br>Min. (Socket) |       | C<br>+.010" (.254)<br>-.018" (.457) |       | D             |       | E             |      | F Max. |      |
|-----------------|---------------|-------|--------------------------------|-------|-------------------------------------|-------|---------------|-------|---------------|------|--------|------|
|                 | ±.010" (.254) |       |                                |       |                                     |       | ±.005" (.127) |       | ±.010" (.254) |      |        |      |
|                 | in            | mm    | in                             | mm    | in                                  | mm    | in            | mm    | in            | mm   | in     | mm   |
| 9 Plug          | .778          | 19.76 | .2918                          | 7.41  | .398                                | 10.11 | .565          | 14.35 | .208          | 5.28 | .173   | 4.39 |
| 9 Socket        | .778          | 19.76 | .2922                          | 7.42  | .398                                | 10.11 | .565          | 14.35 | .208          | 5.28 | .173   | 4.39 |
| 15 Plug         | .928          | 23.57 | .4418                          | 11.22 | .548                                | 13.92 | .715          | 18.16 | .208          | 5.28 | .173   | 4.39 |
| 15 Socket       | .928          | 23.57 | .4422                          | 11.23 | .548                                | 13.92 | .715          | 18.16 | .208          | 5.28 | .173   | 4.39 |
| 21 Plug         | 1.078         | 27.38 | .5918                          | 15.03 | .698                                | 17.73 | .865          | 21.97 | .208          | 5.28 | .173   | 4.39 |
| 21 Socket       | 1.078         | 27.38 | .5922                          | 15.04 | .698                                | 17.73 | .865          | 21.97 | .208          | 5.28 | .173   | 4.39 |
| 25 Plug         | 1.178         | 29.92 | .6918                          | 17.57 | .798                                | 20.27 | .965          | 24.51 | .208          | 5.28 | .173   | 4.39 |
| 25 Socket       | 1.178         | 29.92 | .6922                          | 17.58 | .798                                | 20.27 | .965          | 24.51 | .208          | 5.28 | .173   | 4.39 |
| 31 Plug         | 1.328         | 33.73 | .8418                          | 21.38 | .948                                | 24.08 | 1.115         | 28.32 | .208          | 5.28 | .173   | 4.39 |
| 31 Socket       | 1.328         | 33.73 | .8422                          | 21.39 | .948                                | 24.08 | 1.115         | 28.32 | .208          | 5.28 | .173   | 4.39 |
| 37 Plug         | 1.478         | 37.54 | .9918                          | 25.19 | 1.098                               | 27.89 | 1.265         | 32.13 | .208          | 5.28 | .173   | 4.39 |
| 37 Socket       | 1.478         | 37.54 | .9922                          | 25.20 | 1.098                               | 27.89 | 1.265         | 32.13 | .208          | 5.28 | .173   | 4.39 |
| 51 Plug         | 1.428         | 36.27 | .9418                          | 23.92 | 1.048                               | 26.62 | 1.215         | 30.86 | .250          | 6.35 | .220   | 5.59 |
| 51 Socket       | 1.428         | 36.27 | .9422                          | 23.93 | 1.048                               | 26.62 | 1.215         | 30.86 | .250          | 6.35 | .220   | 5.59 |





**Panel Mounting Dimensions - All-Plastic**



Plug and socket, rear mounted



Plug and socket, front mounted



Plug, front mounted; Socket, rear mounted



**Front Mounting**

**Panel Cutout Dimensions**

| No. of Contacts | A               |       | B               |      | C               |       |
|-----------------|-----------------|-------|-----------------|------|-----------------|-------|
|                 | +.004" (.101mm) |       | +.004" (.101mm) |      | +.005" (.127mm) |       |
|                 | in              | mm    | in              | mm   | in              | mm    |
| 9               | .408            | 10.36 | .172            | 4.37 | .570            | 14.48 |
| 15              | .558            | 14.17 | .172            | 4.37 | .720            | 18.29 |
| 21              | .708            | 17.98 | .172            | 4.37 | .870            | 22.10 |
| 25              | .808            | 20.52 | .172            | 4.37 | .970            | 24.64 |
| 31              | .958            | 24.33 | .172            | 4.37 | 1.120           | 28.45 |
| 37              | 1.108           | 28.14 | .172            | 4.37 | 1.270           | 32.26 |
| 51              | 1.058           | 26.87 | .215            | 5.46 | 1.220           | 30.99 |



**Rear Mounting**

**Rear Cutout Dimensions**

| No. of Contacts | A               |       | B               |      | C               |       |
|-----------------|-----------------|-------|-----------------|------|-----------------|-------|
|                 | +.004" (.101mm) |       | +.004" (.101mm) |      | +.005" (.127mm) |       |
|                 | in              | mm    | in              | mm   | in              | mm    |
| 9               | .373            | 9.47  | .216            | 5.49 | .570            | 14.48 |
| 15              | .523            | 13.28 | .216            | 5.49 | .720            | 18.29 |
| 21              | .674            | 17.12 | .216            | 5.49 | .870            | 22.10 |
| 25              | .774            | 19.66 | .216            | 5.49 | .970            | 24.64 |
| 31              | .924            | 23.47 | .216            | 5.49 | 1.120           | 28.45 |
| 37              | 1.074           | 27.28 | .216            | 5.49 | 1.270           | 32.26 |
| 51              | 1.024           | 26.01 | .259            | 6.58 | 1.220           | 30.99 |



**Edgeboard Mounting**

**Edgeboard Mounting Cutout Dimensions**

| No. of Contacts | D               |       |
|-----------------|-----------------|-------|
|                 | +.005" (.127mm) |       |
|                 | in              | mm    |
| 9               | .570            | 14.48 |
| 15              | .720            | 18.29 |
| 21              | .870            | 22.10 |
| 25              | .970            | 24.64 |
| 31              | 1.120           | 28.45 |
| 37              | 1.270           | 32.26 |
| 51              | 1.220           | 30.99 |

**Terminal Block**

**Contact Arrangements**

(Face view of pin insert)  
(Use reverse order for socket side)



**Ordering Information**

**M83513/10 - C 02 C N**

**Connector Description**

- 10 = Plug, 9-37 Pos., Narrow Profile, Rt. Angle
- 11 = Plug, 51 Pos., Narrow Profile, Rt. Angle
- 12 = Plug, 100 Pos., Narrow Profile, Rt. Angle
- 13 = Socket, 9-37 Pos., Narrow Profile, Rt. Angle
- 14 = Socket, 51 Pos., Narrow Profile, Rt. Angle
- 15 = Socket, 100 Pos., Narrow Profile, Rt. Angle
- 16 = Plug, 9-37 Pos., Std. Profile, Rt. Angle
- 17 = Plug, 51 Pos., Std. Profile, Rt. Angle
- 18 = Plug, 100 Pos., Std. Profile, Rt. Angle
- 19 = Socket, 9-37 Pos., Std. Profile, Rt. Angle
- 20 = Socket, 51 Pos., Std. Profile, Rt. Angle
- 21 = Socket, 100 Pos., Std. Profile, Rt. Angle
- 22 = Plug, 9-37 Pos., Straight Mount
- 23 = Plug, 51 Pos., Straight Mount
- 24 = Plug, 100 Pos., Straight Mount
- 25 = Socket, 9-37 Pos., Straight Mount
- 26 = Socket, 51 Pos., Straight Mount
- 27 = Socket, 100 Pos., Straight Mount

**Hardware**

- N = No Jackpost
- P = Jackpost Attached

**Shell Finish**

- C = Cadmium
- N = Electroless Nickel

**Termination Length**

- 01 = 0.109
- 02 = 0.140
- 03 = 0.172

**Insert Arrangement Length**  
(No. of Contacts)

- A = 9
- B = 15
- C = 21
- D = 25
- E = 31
- F = 37
- G = 51
- H = 100

**90° Termination**  
**(/16-/21)**



**Recommended Board Layout**



NOTE: For additional connector dimensions, see page 5-22.

| No. of<br>Contacts | A<br>Max. |       | B<br>± .007 (0.18) |       | C<br>± .005 (0.13) |       | F<br>Max. |       |
|--------------------|-----------|-------|--------------------|-------|--------------------|-------|-----------|-------|
|                    | in        | mm    | in                 | mm    | in                 | mm    | in        | mm    |
| 9 Plug             | 1.390     | 35.31 | 1.150              | 29.21 | .565               | 14.35 | .465      | 11.81 |
| 9 Socket           | 1.390     | 35.31 | 1.150              | 29.21 | .565               | 14.35 | .465      | 11.81 |
| 15 Plug            | 1.540     | 39.12 | 1.300              | 33.02 | .715               | 18.16 | .465      | 11.81 |
| 15 Socket          | 1.540     | 39.12 | 1.300              | 33.02 | .715               | 18.16 | .465      | 11.81 |
| 21 Plug            | 1.690     | 42.93 | 1.450              | 36.83 | .865               | 21.97 | .465      | 11.81 |
| 21 Socket          | 1.690     | 42.93 | 1.450              | 36.83 | .865               | 21.97 | .465      | 11.81 |
| 25 Plug            | 1.790     | 45.47 | 1.550              | 39.37 | .965               | 24.51 | .465      | 11.81 |
| 25 Socket          | 1.790     | 45.47 | 1.550              | 39.37 | .965               | 24.51 | .465      | 11.81 |
| 31 Plug            | 2.040     | 51.82 | 1.800              | 45.72 | 1.115              | 28.32 | .465      | 11.81 |
| 31 Socket          | 2.040     | 51.82 | 1.800              | 45.72 | 1.115              | 28.32 | .465      | 11.81 |
| 37 Plug            | 2.340     | 59.44 | 2.100              | 53.34 | 1.265              | 32.13 | .465      | 11.81 |
| 37 Socket          | 2.340     | 59.44 | 2.100              | 53.34 | 1.265              | 32.13 | .465      | 11.81 |
| 51 Plug            | 1.875     | 47.63 | 1.600              | 40.64 | 1.215              | 30.86 | .565      | 14.35 |
| 51 Socket          | 1.875     | 47.63 | 1.600              | 40.64 | 1.215              | 30.86 | .565      | 14.35 |
| 100 Plug           | 2.780     | 70.61 | 2.500              | 63.50 | 1.800              | 45.72 | .765      | 19.43 |
| 100 Socket         | 2.780     | 70.61 | 2.500              | 63.50 | 1.800              | 45.72 | .765      | 19.43 |

| No. of<br>Contacts | G<br>Max. |       | H<br>Max. |      | J<br>± .005 (0.13) |      | K<br>± .015 |      |
|--------------------|-----------|-------|-----------|------|--------------------|------|-------------|------|
|                    | in        | mm    | in        | mm   | in                 | mm   | in          | mm   |
| 9 Plug             | .308      | 7.82  | .190      | 4.83 | .096               | 2.44 | .125        | 3.18 |
| 9 Socket           | .308      | 7.82  | .200      | 5.08 | .096               | 2.44 | .125        | 3.18 |
| 15 Plug            | .308      | 7.82  | .190      | 4.83 | .096               | 2.44 | .125        | 3.18 |
| 15 Socket          | .308      | 7.82  | .200      | 5.08 | .096               | 2.44 | .125        | 3.18 |
| 21 Plug            | .308      | 7.82  | .190      | 4.83 | .096               | 2.44 | .125        | 3.18 |
| 21 Socket          | .308      | 7.82  | .200      | 5.08 | .096               | 2.44 | .125        | 3.18 |
| 25 Plug            | .308      | 7.82  | .190      | 4.83 | .096               | 2.44 | .125        | 3.18 |
| 25 Socket          | .308      | 7.82  | .200      | 5.08 | .096               | 2.44 | .125        | 3.18 |
| 31 Plug            | .308      | 7.82  | .190      | 4.83 | .096               | 2.44 | .125        | 3.18 |
| 31 Socket          | .308      | 7.82  | .200      | 5.08 | .096               | 2.44 | .125        | 3.18 |
| 37 Plug            | .308      | 7.82  | .190      | 4.83 | .096               | 2.44 | .125        | 3.18 |
| 37 Socket          | .308      | 7.82  | .200      | 5.08 | .096               | 2.44 | .125        | 3.18 |
| 51 Plug            | .351      | 8.92  | .190      | 4.83 | .096               | 2.44 | .125        | 3.18 |
| 51 Socket          | .351      | 8.92  | .200      | 5.08 | .096               | 2.44 | .125        | 3.18 |
| 100 Plug           | .394      | 10.00 | .190      | 4.83 | .125               | 3.18 | .225        | 5.72 |
| 100 Socket         | .394      | 10.00 | .200      | 5.08 | .125               | 3.18 | .225        | 5.72 |

**Straight (180°) Termination**  
**(/22-/27)**



**Recommended Board Layout**



Typ. Hole Dia. = .040" (1.02 mm)

NOTE: For additional connector dimensions, see page 5-22.

| No. of<br>Contacts | A<br>Max. |       | B<br>± .007 (0.18) |       | C<br>± .005 (0.13) |       | D<br>Max. |       | G<br>Max. |       |
|--------------------|-----------|-------|--------------------|-------|--------------------|-------|-----------|-------|-----------|-------|
|                    | in        | mm    | in                 | mm    | in                 | mm    | in        | mm    | in        | mm    |
| 9 Plug             | 1.390     | 35.31 | 1.150              | 29.21 | .565               | 14.35 | .885      | 22.48 | .308      | 7.75  |
| 9 Socket           | 1.390     | 35.31 | 1.150              | 29.21 | .565               | 14.35 | .885      | 22.48 | .308      | 7.75  |
| 15 Plug            | 1.390     | 35.31 | 1.150              | 29.21 | .715               | 18.16 | .945      | 24.0  | .308      | 7.75  |
| 15 Socket          | 1.390     | 35.31 | 1.150              | 29.21 | .715               | 18.16 | .945      | 24.0  | .308      | 7.75  |
| 21 Plug            | 1.690     | 42.93 | 1.450              | 36.83 | .865               | 21.97 | 1.185     | 30.09 | .308      | 7.75  |
| 21 Socket          | 1.690     | 42.93 | 1.450              | 36.83 | .865               | 21.97 | 1.185     | 30.09 | .308      | 7.75  |
| 25 Plug            | 1.740     | 44.20 | 1.500              | 38.10 | .965               | 24.51 | 1.275     | 32.38 | .308      | 7.75  |
| 25 Socket          | 1.740     | 44.20 | 1.500              | 38.10 | .965               | 24.51 | 1.275     | 32.38 | .308      | 7.75  |
| 31 Plug            | 2.040     | 51.82 | 1.800              | 45.72 | 1.115              | 28.32 | 1.575     | 40.00 | .308      | 7.75  |
| 31 Socket          | 2.040     | 51.82 | 1.800              | 45.72 | 1.115              | 28.32 | 1.576     | 40.00 | .308      | 7.75  |
| 37 Plug            | 2.340     | 59.44 | 2.100              | 53.34 | 1.265              | 32.13 | 1.875     | 47.62 | .308      | 7.75  |
| 37 Socket          | 2.340     | 59.44 | 2.100              | 53.34 | 1.265              | 32.13 | 1.875     | 47.62 | .308      | 7.75  |
| 51 Plug            | 2.270     | 57.66 | 2.000              | 50.80 | 1.215              | 30.86 | 1.775     | 45.08 | .351      | 8.92  |
| 51 Socket          | 2.270     | 57.66 | 2.000              | 50.80 | 1.215              | 30.86 | 1.775     | 45.08 | .351      | 8.92  |
| 100 Plug           | 3.070     | 77.98 | 2.800              | 71.12 | 1.800              | 45.72 | 2.585     | 65.55 | .455      | 11.56 |
| 100 Socket         | 3.070     | 77.98 | 2.800              | 71.12 | 1.800              | 45.72 | 2.585     | 65.65 | .455      | 11.56 |

| No. of<br>Contacts | H<br>Max. |      | J<br>± .005 (0.13) |      | K<br>Max. |      | L<br>Max. |       |
|--------------------|-----------|------|--------------------|------|-----------|------|-----------|-------|
|                    | in        | mm   | in                 | mm   | in        | mm   | in        | mm    |
| 9 Plug             | .190      | 4.83 | .096               | 2.44 | .165      | 4.19 | .355      | 9.02  |
| 9 Socket           | .200      | 5.08 | .096               | 2.44 | .165      | 4.19 | .355      | 9.02  |
| 15 Plug            | .190      | 4.83 | .096               | 2.44 | .165      | 4.19 | .355      | 9.02  |
| 15 Socket          | .200      | 5.08 | .096               | 2.44 | .165      | 4.19 | .355      | 9.02  |
| 21 Plug            | .190      | 4.83 | .096               | 2.44 | .165      | 4.19 | .355      | 9.02  |
| 21 Socket          | .200      | 5.08 | .096               | 2.44 | .165      | 4.19 | .355      | 9.02  |
| 25 Plug            | .190      | 4.83 | .096               | 2.44 | .165      | 4.19 | .355      | 9.02  |
| 25 Socket          | .200      | 5.08 | .096               | 2.44 | .165      | 4.19 | .355      | 9.02  |
| 31 Plug            | .190      | 4.83 | .096               | 2.44 | .165      | 4.19 | .355      | 9.02  |
| 31 Socket          | .200      | 5.08 | .096               | 2.44 | .165      | 4.19 | .355      | 9.02  |
| 37 Plug            | .190      | 4.83 | .096               | 2.44 | .165      | 4.19 | .355      | 9.02  |
| 37 Socket          | .200      | 5.08 | .096               | 2.44 | .165      | 4.19 | .355      | 9.02  |
| 51 Plug            | .190      | 4.83 | .096               | 2.44 | .165      | 4.19 | .355      | 9.02  |
| 51 Socket          | .200      | 5.08 | .096               | 2.44 | .165      | 4.19 | .355      | 9.02  |
| 100 Plug           | .190      | 4.83 | .125               | 3.18 | .300      | 7.62 | .550      | 13.97 |
| 100 Socket         | .200      | 5.08 | .125               | 3.18 | .300      | 7.62 | .550      | 13.97 |

**90° Narrow Termination  
 (/10-15)**



**Recommended Board Layout**

**(As Viewed from Bottom  
 of Terminal Block)**

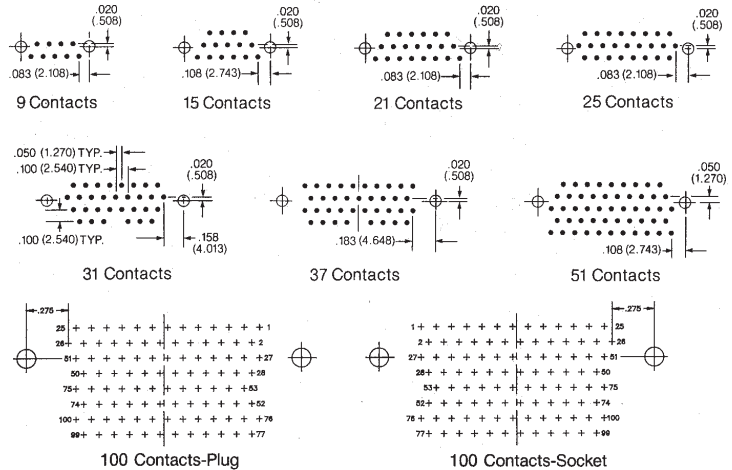

NOTE: For additional connector dimensions, see page 5-22.

Typ. Hole Dia. = .040" (1.02 mm)

5

| No. of<br>Contacts | A<br>Max. |       | B<br>± .005 (0.13) |       | C<br>Max. |       |
|--------------------|-----------|-------|--------------------|-------|-----------|-------|
|                    | in        | mm    | in                 | mm    | in        | mm    |
| 9 Plug             | .785      | 19.94 | .565               | 14.35 | .308      | 7.82  |
| 9 Socket           | .785      | 19.94 | .565               | 14.35 | .308      | 7.82  |
| 15 Plug            | .935      | 23.75 | .715               | 18.16 | .308      | 7.82  |
| 15 Socket          | .935      | 23.75 | .715               | 18.16 | .308      | 7.82  |
| 21 Plug            | 1.085     | 27.56 | .865               | 21.97 | .308      | 7.82  |
| 21 Socket          | 1.085     | 27.56 | .865               | 21.97 | .308      | 7.82  |
| 25 Plug            | 1.085     | 30.10 | .965               | 24.51 | .308      | 7.82  |
| 25 Socket          | 1.185     | 30.10 | .965               | 24.51 | .308      | 7.82  |
| 31 Plug            | 1.335     | 33.91 | 1.115              | 28.32 | .308      | 7.82  |
| 31 Socket          | 1.335     | 33.91 | 1.115              | 28.32 | .308      | 7.82  |
| 37 Plug            | 1.485     | 37.72 | 1.265              | 32.13 | .308      | 7.82  |
| 37 Socket          | 1.485     | 37.72 | 1.265              | 32.13 | .308      | 7.82  |
| 51 Plug            | 1.435     | 36.45 | 1.215              | 30.86 | .351      | 8.92  |
| 51 Socket          | 1.435     | 36.45 | 1.215              | 30.86 | .351      | 8.92  |
| 100 Plug           | 2.175     | 55.25 | 1.800              | 45.72 | .394      | 10.00 |
| 100 Socket         | 2.175     | 55.25 | 1.800              | 45.72 | .394      | 10.00 |

| No. of<br>Contacts | F<br>± .010 (0.25) |      | G<br>± .010 (0.25) |       | H<br>Max. |       | J<br>± .005 (0.13) |      |
|--------------------|--------------------|------|--------------------|-------|-----------|-------|--------------------|------|
|                    | in                 | mm   | in                 | mm    | in        | mm    | in                 | mm   |
| 9 Plug             | .230               | 5.84 | .250               | 6.35  | .420      | 10.67 | .096               | 2.44 |
| 9 Socket           | .230               | 5.84 | .250               | 6.35  | .420      | 10.67 | .096               | 2.44 |
| 15 Plug            | .130               | 3.30 | .250               | 6.35  | .420      | 10.67 | .096               | 2.44 |
| 15 Socket          | .130               | 3.30 | .250               | 6.35  | .420      | 10.67 | .096               | 2.44 |
| 21 Plug            | .130               | 3.30 | .250               | 6.35  | .420      | 10.67 | .096               | 2.44 |
| 21 Socket          | .130               | 3.30 | .250               | 6.35  | .420      | 10.67 | .096               | 2.44 |
| 25 Plug            | .130               | 3.30 | .250               | 6.35  | .420      | 10.67 | .096               | 2.44 |
| 25 Socket          | .130               | 3.30 | .250               | 6.35  | .420      | 10.67 | .096               | 2.44 |
| 31 Plug            | .130               | 3.30 | .250               | 6.35  | .520      | 13.21 | .996               | 2.44 |
| 31 Socket          | .130               | 3.30 | .250               | 6.35  | .520      | 13.21 | .096               | 2.44 |
| 37 Plug            | .130               | 3.30 | .250               | 6.35  | .520      | 13.21 | .096               | 2.44 |
| 37 Socket          | .130               | 3.30 | .250               | 6.35  | .520      | 13.21 | .096               | 2.44 |
| 51 Plug            | .150               | 3.81 | .300               | 7.62  | .650      | 16.51 | .096               | 2.44 |
| 51 Socket          | .150               | 3.81 | .300               | 7.62  | .650      | 16.51 | .096               | 2.44 |
| 100 Plug           | .200               | 5.08 | .400               | 10.16 | 1.000     | 25.40 | .125               | 3.18 |
| 100 Socket         | .200               | 5.08 | .400               | 10.16 | 1.000     | 25.40 | .125               | 3.18 |

**Mounting Hardware**



High Profile Jackscrew



Low Profile Jackscrew



Removable Jackpost

**Ordering Information**

| Type      | Style        | Screwhead    | Thread | Military Part No. |
|-----------|--------------|--------------|--------|-------------------|
| Jackscrew | Low Profile  | Recessed Hex | 2/56   | M83513/5-02       |
| Jackscrew | High Profile | Recessed Hex | 2/56   | M83513/5-03       |
| Jackscrew | Low Profile  | Slotted      | 2/56   | M83513/5-05       |
| Jackscrew | High Profile | Slotted      | 2/56   | M83513/5-06       |
| Jackpost  | --           | --           | 2/56   | M83513/5-07       |
| Jackscrew | Low Profile  | Hex          | 4/40*  | M83513/5-12       |
| Jackscrew | High Profile | Hex          | 4/40*  | M83513/5-13       |
| Jackscrew | Low Profile  | Slotted      | 4/40*  | M83513/5-15       |
| Jackscrew | High Profile | Slotted      | 4/40*  | M83513/5-16       |
| Jackpost  | --           | --           | 4/40*  | M83513/5-17       |

\*100 Size Only

**Dura-Con**  
**High Reliability**  
**All-Plastic & Metal Shell**

.050" (1.27mm) Density  
 Connector Saver



FEATURES

- *Designed to significantly reduce damage to already mounted Dura-Con connectors during routine system tests.*
- *Eliminates numerous mating & unmating cycles experienced by connectors on test harnesses.*
- *Plug connector on one end, socket connector on the other.*
- *Available in all-plastic (polyester) or in metal shell with diallyl phthalate or polyester insulators (both UL94V-0 rated).*
- *Locking hardware must be ordered separately.*



MATERIALS

**Insulator:** UL94V-0 glass-filled polyester or diallyl phthalate  
**Contacts:** Copper alloy  
**Contact Plating:** .000050 in gold  
**Shell (Metal Only):** Aluminum alloy  
**Shell Plating:** Yellow chromate over cadmium

ENVIRONMENTAL

**Operating Temperature:** -55°C to +135°C

ELECTRICAL

**Current Rating:** 3 Amps maximum  
**Withstanding Voltage:** 600 VAC RMS @ sea level  
**Contact Resistance:** 8 milliohms maximum

MECHANICAL

**Individual Contact:** Insertion force, 6 oz. (170.40 g) maximum;  
 Withdrawal force 0.5 oz. (14.20 g) minimum  
**Mating / Unmating Forces:** See previous tables

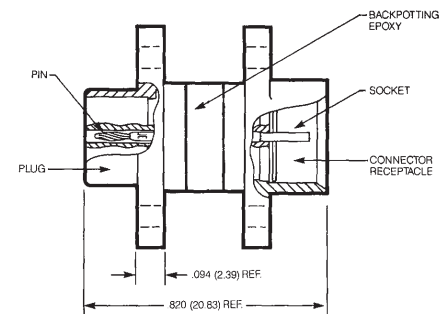

| No. of Contacts | Metal Shell                      |                                       | All Plastic                           |
|-----------------|----------------------------------|---------------------------------------|---------------------------------------|
|                 | Diallyl Phthalate<br>Catalog No. | Glass-Filled Polyester<br>Catalog No. | Glass-Filled Polyester<br>Catalog No. |
| 9               | DCCM9CS                          | DCDM9CS                               | DCDA9CS                               |
| 15              | DCCM15CS                         | DCDM15CS                              | DCDA15CS                              |
| 21              | DCCM21CS                         | DCDM21CS                              | DCDA21CS                              |
| 25              | DCCM25CS                         | DCDM25CS                              | DCDA25CS                              |
| 31              | DCCM31CS                         | DCDM31CS                              | DCDA31CS                              |
| 37              | DCCM37CS                         | DCDM37CS                              | DCDA37CS                              |
| 51              | DCCM51CS                         | DCDM51CS                              | DCDA51CS                              |
| 100             | DCCM100CS                        | DCDM100CS                             | -                                     |

**Dura-Con  
High Reliability  
Microedge Connectors**

.050" (1.27mm) Density  
PC Board Mount  
Metal Shell



FEATURES

- **Variety of available PC board mounting styles.**
  - “Coke Bottle” for edge mounting on double-sided PCBs
  - Right-angle (90°) mounting for single- or double-sided daughter boards
  - “Claw Foot” leads
  - Gold-plated solid copper wire pigtails
- **Harnessing capabilities exist for both plug & socket.**
- **Standard sizes are 128 and 184 positions.**
- **Utilizes high-reliability Dura-Con twist pin contact system assuring electrical continuity under extreme shock and vibration.**
- **Aluminum shells and diallyl phthalate insulators make Dura-Con microedge connectors ideal for airborne or space applications.**
- **Microedge metal shell connectors meet the requirement of MIL-C-55302.**

MATERIALS

**Insulator:** UL94V-0 glass-filled polyester or diallyl phthalate per MIL-M-14 (green)  
**Contacts:** Copper alloy  
**Contact Plating:** .000050 in Gold  
**Shell:** Aluminum alloy  
**Shell Plating:** Electroless Nickel

ENVIRONMENTAL

**Operating Temperature:** -55°C to +135°C

ELECTRICAL

**Current Rating:** 3 Amps maximum  
**Withstanding Voltage:** 600 VAC RMS @ sea level, 300 VAC @ 70,000 ft.  
**Contact Resistance:** 8 milliohms maximum

MECHANICAL

**Insertion/Withdrawal Force:**  
 6 oz. (170.40 g[f]) maximum insertion force, per contact;  
 0.5 oz. (14.20 g[f]) minimum withdrawal force, per contact





**128 Contact Receptacle (Right Angle)**



**Side View and Termination Grid Pattern**



**128 Contact Receptacle (Stranded Insulated Wire)**



**Side View**



**128 Contact Plug (Claw Foot)**



**Side View and Termination Grid Pattern**



**Dura-Con**  
**High Reliability**  
**Microedge Connectors**

.050" (1.27mm) Density  
 PC Board Mount  
 Metal Shell



**128 Contact Plug (Stranded Insulated Wire)**



**Side View**

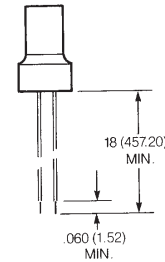

**184 Contact Receptacle (Coke Bottle)**



**Side View**



Recommended PCB thickness .047-.062.  
 Consult factory for other thicknesses.

**184 Contact Receptacle (Stranded Insulated Wire)**



**Side View**

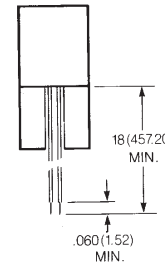

**184 Contact Plug (Claw Foot)**



**Side View and Termination Grid Pattern**



\* Narrow Version (DNEB) .250 Wide

**Dura-Con  
High Reliability  
Microedge Connectors**

.050" (1.27mm) Density  
PC Board Mount  
Metal Shell



**184 Contact Plug (Standard Insulated Wire)**



**Side View**



\* Narrow Version (DNEB) .250 Wide

**Shell Polarization Kit**

| Order No. | "L"  | Used On          |
|-----------|------|------------------|
| DNEBP0L1  | .250 | DNEB Narrow Only |
| DMEBP0L1  | .312 | DMEB Std. Width  |

**Key**



**Mounting Hardware**

**Removable Jackscrew/Jackpost Assembly**



Consult factory if required.

**Standard Jackscrew/Jackpost Assembly**



Plug with Jackscrew



Receptacle with Jackscrew

**Ordering Information**

**DMEB 1-128 P 6 E 2 180**

**Series Prefix**  
DMEB = Microedgeboard  
DNEB = Microedgeboard, Narrow (184 Only)

**Contact Spacing**  
1 = .050" (1.27mm) centers  
128/184  
2 = .100" (2.54mm) centers  
64/92 (every other contact hole)  
For other contact spacing accommodations, consult the factory.

**No. of Contacts**  
128, 184

**Contact Type**  
P = Pin  
S = Socket

**Wire Size in AWG**  
5 = 25 AWG Solid Copper  
6 = 26 AWG Stranded Wire  
S = Solder Cup

\*Indicates Cinch std Option

**Lead Length in Inches**

**Termination, Color of Finish**  
1 = White  
\*2 = Yellow  
3 = Tin-Plated  
\*4 = Gold-Plated (Solid Copper Wire Only)  
\*5 = Color Coded per MIL-Std. 681, System 1

**Wire Type/Termination Style**  
C = Solid Copper  
E = MIL-W-16878/4, 7 Strand  
BS = PC Board (Coke Bottle)  
BRA = PC Board Right-Angle (Formed to "A" Side)  
BRB = PC Board Right-Angle (Formed to "B" Side)  
W = PC Board (Claw Foot)

**Dura-Con  
High Reliability  
Strip Connectors**

.050" (1.27mm) Density  
Solder Cup/Wire  
All-Plastic



FEATURES

- *Lightweight.*
- *Slim Profile.*
- *High-Density Interconnect.*
- *High-reliability Dura-Con twist pin contact system for extreme shock & vibration applications.*
- *Optional polarization with guide pins to prevent mismatching connectors.*
- *Plug & socket available in sizes from 1 to 60 positions.*

MATERIALS

**Insulator:** UL94V-0 glass-filled polyester  
**Contacts:** Copper alloy  
**Contact Plating:** .000050 in gold



ENVIRONMENTAL

**Operating Temperature:** -55°C to +135°C



ELECTRICAL

**Current Rating:** 3 Amps maximum  
**Withstanding Voltage:** 600 VAC @ sea level;  
150 VAC @ 70,000 ft.  
**Contact Resistance:** 8 milliohms maximum

MECHANICAL

**Insertion & Withdrawal Force (Per Contact):**  
6 oz. (170.40 g[f]) maximum insertion;  
0.5 oz. (14.20 g[f]) minimum withdrawal

# Dura-Con High Reliability Strip Connectors

.050" (1.27mm) Density  
Solder Cup/Wire  
All Plastic



## Dimensions

### Socket Connector



### Pin Connector



### 24 Gauge Stainless Steel Guide Pin\*



NOTE: Dimension A is number of positions less 1 multiplied by .050

\* Assembly in socket connector only.

## Ordering Information



\* - Indicates Cinch std. option.  
\*\* - Consult factory for larger sizes and multi-row.

# Mouser Electronics

Authorized Distributor

Click to View Pricing, Inventory, Delivery & Lifecycle Information:

## Cinch Connectivity Solutions:

[DCCM31SCBRPN](#) [DCCM15SBSP](#) [DCCM100PCBRP](#) [DCCM21P6E5-18.0B](#) [DCCM21PCBRPN](#) [DCCM25SCBRP](#)  
[DCCM31PBSPN](#) [DCCM31S6E5-36.0B](#) [DCCM37PSBN](#) [DCCM51PSB](#) [DCCM9P6E5-36.0B](#) [DCCM100S6E5-36.0B](#)  
[DCCM100SBSP](#) [DCCM15S6E5-18.0BN](#) [DCCM21PSB](#) [DCCM25PCBRPN](#) [DCCM25SBSP](#) [DCCM31S6E5-18.0BN](#)  
[DCCM37P6E5-36.0BN](#) [DCCM37SCBRPN](#) [DCCM51SBSP](#) [DCCM9SBSP](#) [DCCM9SSBN](#) [DCCM15P6E5-36.0B](#)  
[DCCM15S6E5-36.0B](#) [DCCM21SSB](#) [DCCM25PCBRP](#) [DCCM25S6E5-36.0BN](#) [DCCM31PBSP](#) [DCCM9PBSP](#)  
[DCCM9S6E5-36.0BN](#) [DCCM51P6E5-36.0B](#) [DCCM25PBSP](#) [DCCM100PBSP](#) [DCCM100SBSPN](#) [DCCM37P6E5-](#)  
[18.0B](#) [DCCM37S6E5-18.0BN](#) [DCCM37SCBRP](#) [DCCM37SSB](#) [DCCM51PCBRP](#) [DCCM51SBSPN](#) [DCCM15P6E5-](#)  
[18.0BN](#) [DCCM15P6E5-36.0BN](#) [DCCM15S6E5-36.0BN](#) [DCCM21SCBRPN](#) [DCCM21SSBN](#) [DCCM25PBSPN](#)  
[DCCM37P6E5-18.0BN](#) [DCCM37PSB](#) [DCCM37S6E5-18.0B](#) [DCCM37SSBN](#) [DCCM9P6E5-36.0BN](#) [DCCM9PBSPN](#)  
[DCCM15S6E5-18.0B](#) [DCCM21P6E5-36.0B](#) [DCCM21SCBRP](#) [DCCM25SBSPN](#) [DCCM25SCBRPN](#) [DCCM31S6E5-](#)  
[36.0BN](#) [DCCM37S6E5-36.0BN](#) [DCCM51S6E5-36.0BN](#) [DCCM9PSB](#) [DCCM9S6E5-18.0B](#) [DCCM100S6E5-36.0BN](#)  
[DCCM15P6E5-18.0B](#) [DCCM21PBSP](#) [DCCM21PBSPN](#) [DCCM21PCBRP](#) [DCCM25P6E5-36.0B](#) [DCCM25P6E5-](#)  
[36.0BN](#) [DCCM25SSB](#) [DCCM51SSBN](#) [DCCM9P6E5-18.0B](#) [DCCM9SBSPN](#) [DCCM9SCBRPN](#) [DCCM100S6E5-](#)  
[18.0BN](#) [DCCM15PBSP](#) [DCCM9S6E5-18.0BN](#) [DCCM37PCBRP](#) [DCCM51P6E5-18.0B](#) [DCCM51P6E5-36.0BN](#)  
[DCCM51PBSP](#) [DCCM51SSB](#) [DCCM21P6E5-18.0BN](#) [DCCM21S6E5-18.0B](#) [DCCM31P6E5-36.0BN](#) [DCCM31S6E5-](#)  
[18.0B](#) [DCCM37P6E5-36.0B](#) [DCCM51SCBRPN](#) [DCCM37PBSPN](#) [DCCM9P6E5-18.0BN](#) [DCCM9SCBRP](#)  
[DCCM100PBSPN](#) [DCCM100PCBRPN](#) [DCCM15SSBN](#) [DCCM15SBSPN](#) [DCCM15SCBRP](#) [DCCM37PBSP](#)  
[DCCM51S6E5-18.0BN](#) [DCCM51S6E5-36.0B](#)

Компания «Океан Электроники» предлагает заключение долгосрочных отношений при поставках импортных электронных компонентов на взаимовыгодных условиях!

Наши преимущества:

- Поставка оригинальных импортных электронных компонентов напрямую с производств Америки, Европы и Азии, а так же с крупнейших складов мира;
- Широкая линейка поставок активных и пассивных импортных электронных компонентов (более 30 млн. наименований);
- Поставка сложных, дефицитных, либо снятых с производства позиций;
- Оперативные сроки поставки под заказ (от 5 рабочих дней);
- Экспресс доставка в любую точку России;
- Помощь Конструкторского Отдела и консультации квалифицированных инженеров;
- Техническая поддержка проекта, помощь в подборе аналогов, поставка прототипов;
- Поставка электронных компонентов под контролем ВП;
- Система менеджмента качества сертифицирована по Международному стандарту ISO 9001;
- При необходимости вся продукция военного и аэрокосмического назначения проходит испытания и сертификацию в лаборатории (по согласованию с заказчиком);
- Поставка специализированных компонентов военного и аэрокосмического уровня качества (Xilinx, Altera, Analog Devices, Intersil, Interpoint, Microsemi, Actel, Aeroflex, Peregrine, VPT, Syfer, Eurofarad, Texas Instruments, MS Kennedy, Miteq, Cobham, E2V, MA-COM, Hittite, Mini-Circuits, General Dynamics и др.);

Компания «Океан Электроники» является официальным дистрибьютором и эксклюзивным представителем в России одного из крупнейших производителей разъемов военного и аэрокосмического назначения «JONHON», а так же официальным дистрибьютором и эксклюзивным представителем в России производителя высокотехнологичных и надежных решений для передачи СВЧ сигналов «FORSTAR».



## JONHON

«JONHON» (основан в 1970 г.)

Разъемы специального, военного и аэрокосмического назначения:

(Применяются в военной, авиационной, аэрокосмической, морской, железнодорожной, горно- и нефтедобывающей отраслях промышленности)

«FORSTAR» (основан в 1998 г.)

ВЧ соединители, коаксиальные кабели, кабельные сборки и микроволновые компоненты:

(Применяются в телекоммуникациях гражданского и специального назначения, в средствах связи, РЛС, а так же военной, авиационной и аэрокосмической отраслях промышленности).



Телефон: 8 (812) 309-75-97 (многоканальный)

Факс: 8 (812) 320-03-32

Электронная почта: [ocean@oceanchips.ru](mailto:ocean@oceanchips.ru)

Web: <http://oceanchips.ru/>

Адрес: 198099, г. Санкт-Петербург, ул. Калинина, д. 2, корп. 4, лит. А