

400 mA nano-quiescent synchronous step-down converter with digital voltage selection and Power Good

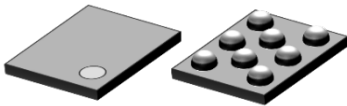

Flip-Chip8 (1.14x1.44 mm)

Features

- 500 nA input quiescent current at $V_{IN}=3.6$ V (not switching)
- 94% typical efficiency at 1 mA load ($V_{IN}=3.6$ V, $V_{OUT}=3.3$ V)
- 100% duty cycle
- 1.8 V to 5.5 V input operating range
- Undervoltage lockout: 1.57 V (V_{IN} falling, typ.)
- Up to 400 mA output current capability
- Low power control operation for the best efficiency
- Embedded soft-start circuit
- Tiny external components: $L=2.2$ μ H typ.
- Selectable output voltages: 1.8 V to 3.3 V
- Output voltage Power Good
- $\pm 1.5\%$ output voltage accuracy (V_{OUT} , $T_A=25$ °C)
- Dynamic output voltage selection (D0, D1)
- Available in Flip-Chip package

Applications

- Wearable applications
- Personal tracking monitors
- Smart watches, sport bands
- Energy harvesting, wireless sensors
- Wearable and fitness accessories
- Industrial sensors, portable low power devices
- Single cell Li-Ion battery applications
- Bluetooth® low energy
- Zigbee

Description

The **ST1PS01** is a nano-quiescent miniaturized synchronous step-down converter, which is able to provide up to 400 mA output current with an input voltage ranging from 1.8 V to 5.5 V. This converter is specifically designed for applications where high efficiency, PCB size and thickness are the key factors. The output voltage can be set using two digital control inputs, a V_{OUT} from 1.8 V to 3.3 V can be dynamically selected. Thanks to the enhanced PCC (peak current control) the **ST1PS01** reaches very high efficiency conversion using just a 2.2 μ H inductor and two small capacitors. Advanced design circuitry is implemented to minimize the quiescent current. The device is available in Flip-Chip package.

Product status link	
ST1PS01	
Product summary	
Order code	ST1PS01AJR
	ST1PS01DJR
	ST1PS01EJR
Output voltages	1.9 V, 2.0 V, 2.1 V, 2.8 V (A vers.)
	1.8 V, 2.3 V, 2.5 V, 2.8 V (D vers.)
	1.8 V, 2.7 V, 3.0 V, 3.3 V (E vers.)
Package	Flip-Chip (1.11x1.41mm) 400 μ m pitch

1 Application schematic

Figure 1. ST1PS01 application schematic

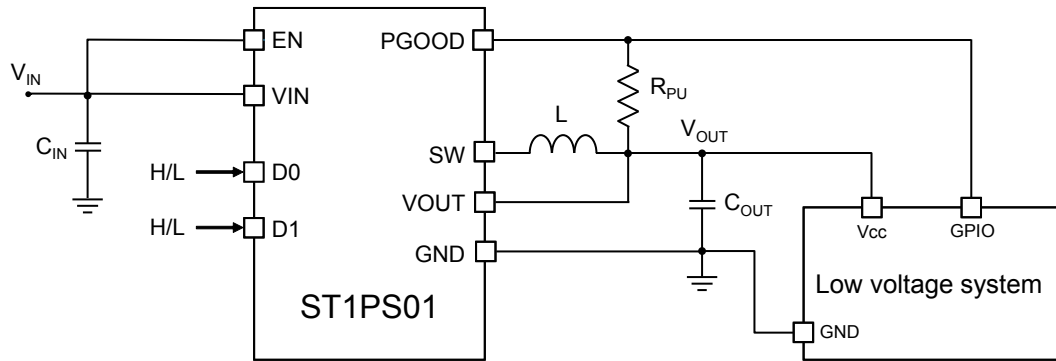

Table 1. Typical external components

Component	Description	Value	Size - imperial (metric)
C_{IN}	Ceramic capacitor with low ESR values	10 μ F	0603 (1608)
C_{OUT}	Ceramic capacitor with low ESR values	10 μ F	0603 (1608)
L	Inductor	2.2 μ H	0806 (2016)
R_{PU}	Pull-up resistor	1 M Ω	0402 (1005)

2 Pin configuration (top through view)

Figure 2. Flip-Chip8 package

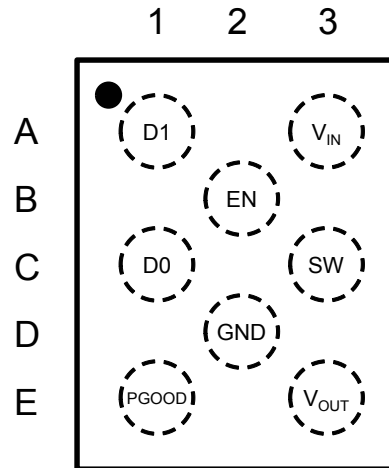

Table 2. Pin description

Name	Bump name	Description
V _{IN}	A3	Input supply voltage. Bypass this pin to ground with a 10 μF capacitor
SW	C3	Switching node. Inductor connection
V _{OUT}	E3	Sense pin used to monitor output voltage
EN	B2	Enable pin. High logic level turns on the IC. V _{IN} referred
GND	D2	Ground
D1	A1	Output voltage selection inputs (Refer to the Table 7. Output voltage settings for order codes and configuration matrix)
D0	C1	
PGOOD	E1	Open drain output. It is in high impedance when the output voltage reaches 97.5% of the target V _{OUT}

3 Functional pin description

GND

Device ground pin.

VIN

Supply voltage. This pin supplies power to the internal analog and digital circuitries when voltage is higher than V_{UVLO} . Bypass this pin to GND with a 10 μ F ceramic capacitor. Input capacitor C_{IN} must be chosen with low ESR to reduce the input voltage ripple.

SW

Inductor connection to internal PMOS and NMOS switches.

VOUT

Output voltage sense input. It provides the feedback voltage level to the regulation circuitry. 10 μ F output capacitor C_{OUT} must be connected close to the pin or through a short trace and should have low ESR to reduce the output voltage ripple.

EN

Enable pin. A logic low level on this pin disables the device. High level enables the device. Do not leave this pin floating.

D1, D2

Output voltage selection pins. See the [Table 7. Output voltage settings](#) for V_{OUT} selection. Do not leave these pins floating. These pins can be dynamically changed during operation.

PGOOD

Power Good open drain output. If used it requires a pull-up resistor to hold a high level signal. High impedance indicates that V_{OUT} is above proper good threshold.

4 Maximum ratings

Table 3. Absolute maximum ratings

Symbol	Parameter	Value	Unit
V_{IN}	Power and signal supply voltage	- 0.3 to + 6.5	V
EN, D0, D1	Logic input pins	- 0.3 to + 6.5	V
V_{OUT} , SW	Output signal monitoring and switching pins	-0.3 to V_{IN} + 0.3	V
PGOOD	Power Good open drain output pin	- 0.3 to + 6.5	V
T_{AMB}	Operating ambient temperature	-40 to 85	°C
T_J	Junction temperature	-40 to 125	°C
T_{STG}	Storage temperature	-55 to 150	°C

Note: Absolute maximum ratings are those values beyond which damage to the device may occur. Functional operation under these conditions is not implied

Table 4. Thermal data

Symbol	Parameter	Flip-Chip8	Unit
R_{thJA}	Thermal resistance junction-ambient	60	°C/W

Table 5. Recommended operating conditions

Symbol	Parameter	Min.	Typ.	Max.	Unit
V_{IN}	Input supply voltage	1.8		5.5	V

5 Electrical characteristics

$C_{IN}= 10 \mu\text{F}$, $C_{OUT}= 10 \mu\text{F}$, $L=2.2 \mu\text{H}$, $V_{IN}=3.6 \text{ V}$, $V_{EN}= V_{IN}$, $V_{OUT}=1.8 \text{ V}$, $T_A=25 \text{ }^\circ\text{C}$ unless otherwise specified.

Table 6. Electrical characteristics

Symbol	Parameter	Test conditions	Min.	Typ.	Max.	Unit
General section						
I_Q	Quiescent current	$V_{IN}=V_{IN}$, $I_{OUT}=0 \mu\text{A}$, $V_{OUT}=1.8 \text{ V}$, device does not switch, $V_{IN}=2.5 \text{ V}$ to 5.5 V		500	1000	nA
I_{SD}	Shutdown current	$V_{EN}=\text{GND}$, shutdown current into V_{IN}		10	200	nA
V_{UVLO}	Undervoltage lockout threshold	V_{IN} rising		1.63	1.72	V
		V_{IN} falling	1.51	1.57		V
		Hysteresis		65		mV
$V_{th100\%+}$	100% mode leave threshold	V_{IN} rising, 100% mode is disabled with $V_{IN} = V_{OUTnom} + V_{th100\%+}$		300		mV
$V_{th100\%-}$	100% mode enter threshold	V_{IN} falling, 100% mode is entered with $V_{IN} = V_{OUTnom} + V_{th100\%-}$		200		
Output voltage						
V_{OUT}	Output voltage range	Output voltages are selected with pins D0, D1	1.8		3.3	V
	Output voltage accuracy	$V_{IN} = 3.6 \text{ V}$, whole V_{OUT} range, $I_{OUT}=100 \text{ mA}$	-1.5		1.5	%
t_{ONmin}	Minimum on-time	$V_{IN} = 3.6 \text{ V}$, $V_{OUT}= 2 \text{ V}$, $I_{OUT}= 0 \text{ mA}$		200		ns
t_{OFFmin}	Minimum off-time	$V_{IN}=2.3\text{V}$		50		ns
$t_{startupd}$	Start-up delay time	V_{EN} from low to high, $V_{IN} = 3.6 \text{ V}$, $V_{OUT} = 1.8 \text{ V}$	0.5		4	ms
R_{OUTDIS}	Output discharge MOSFET on-resistance	$V_{EN}= \text{GND}$		30		Ω
Logic inputs (EN, D0, D1)						
V_{IL}	Low level input voltage threshold	$V_{IN}=1.8 \text{ V}$ to 5.5 V			0.3	V
V_{IH}	High level input voltage threshold		1			
Power switch						
$R_{DS(on)}$	High-side MOSFET on-resistance	$V_{IN} = 3.6 \text{ V}$, $I_{sw} = 400 \text{ mA}$		0.38	0.45	Ω
	Low-side MOSFET on-resistance			0.14	0.2	
I_{LIM1}	High-side MOSFET switch current limit	$1.8 \text{ V} \leq V_{IN} \leq 5.5 \text{ V}$		580	700	mA
	Low-side MOSFET switch current limit			500		
I_{LIMSS}	High-side MOSFET switch current limit during soft-start	Reduced switch current limit during soft-start period (typ. $400 \mu\text{s}$)	200	280	360	
Power Good output (PGOOD)						
V_{thpg-}	Power Good threshold voltage	Rising output voltage on V_{OUT} pin, referred to V_{OUT} selected (D0, D1)	95	97.5		%
V_{thpgH}		Hysteresis. To see plot for temperature variation	-6	-4.25	-2.5	
V_{OL}	Low level output voltage	$1.8 \text{ V} \leq V_{IN} \leq 5.5 \text{ V}$, $V_{EN} = \text{GND}$, current into PGOOD pin, $I_{PGOOD} = 4 \text{ mA}$			0.23	V

Table 7. Output voltage settings

Device	D1	D0	V _{OUT}
ST1PS01AJR	0	0	1.9 V
	0	1	2.0 V
	1	0	2.1 V
	1	1	2.8 V
ST1PS01DJR	0	0	1.8 V
	0	1	2.3 V
	1	0	2.5 V
	1	1	2.8 V
ST1PS01EJR	0	0	1.8 V
	0	1	2.7 V
	1	0	3.0 V
	1	1	3.3 V

7 Operation description

The ST1PS01 is an ultra-low quiescent new generation buck converter. It targets a very small quiescent current consumption (typical 500 nA) and it guarantees high efficiency operation even down to few microampere loads. It is based on a hysteretic comparator that senses the coil ripple current that is always held constant in all operation modes. The device has seamless transition between PFM (pulse frequency modulation) and PWM (pulse width modulation) mode with low ripple and good load transient response. In order to maintain constant ripple current on the selected coil, the device changes switching frequency, which also depends on input supply voltage. During PWM mode (heavy load), the device operates in continuous conduction up to 400 mA and switching frequency can reach 2 MHz maximum.

7.1 Power save mode

At light load the device enters automatically power save mode with total current consumption from the input power supply of 500 nA typical; during this condition most of the internal blocks are turned off in order to reach ultra-low power consumption. During this time, the load current is supported by the output capacitor.

7.2 Output voltage

The device allows output voltage selection without external resistor divider. A couple of standard digital inputs are used to configure the device to supply a fixed output voltage according to [Table 7. Output voltage settings](#). The V_{OUT} pin **must be connected directly** and **as close as possible to the inductor terminal** to obtain the best performance and get the best output voltage regulation. The output voltage can be dynamically changed to implement voltage scaling.

7.3 Output discharge and UVLO

The device embeds a fast output discharge circuitry active when the enable pin is held to ground (EN=gnd) or when the input supply voltage reaches the minimum voltage level set by the UVLO protection circuit (undervoltage lock-out protection circuit). The UVLO rising threshold at 1.63 V (typ.) guarantees a proper device supply voltage operation.

7.4 Soft-start and current limitation

The device embeds a fixed soft-start circuit active during a limited time period (few ms). This feature allows the inrush current to be minimized from the power supply in case of weak source. During this period internal circuit reduces to 280 mA the typical switch current limit.

7.5 100% duty cycle operation

The device enters 100% duty cycle operation if the input voltage comes close to the selected output voltage. During this mode, the regulator is turned off and output pin is directly connected to the input pin through the high-side MOSFET. The output voltage follows the input level minus the voltage drop across the internal MOSFET and the inductor. Once the input voltage exceeds the 100% duty cycle leave threshold, the device restarts to switch and regulates the selected output voltage again.

7.6 Power Good flag

The Power Good comparator monitors the selected V_{OUT} voltage. The Power Good open drain output is in high impedance when the V_{OUT} reaches the correct voltage level while it switches to low level when V_{OUT} falls below the normal voltage level.

8 Typical performance characteristics

Figure 4. Efficiency vs load, $V_{OUT} = 1.8\text{ V}$

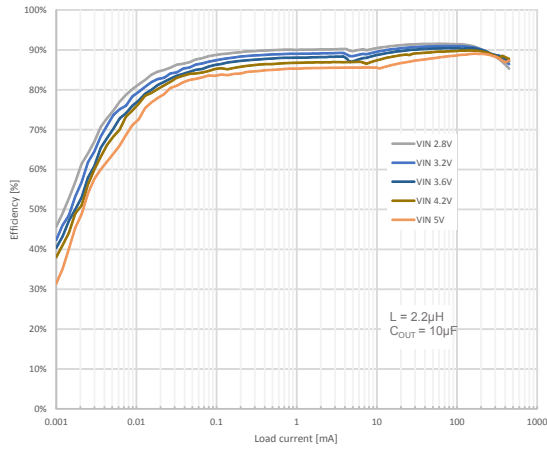

Figure 5. Efficiency vs V_{IN} , $V_{OUT} = 1.8\text{ V}$

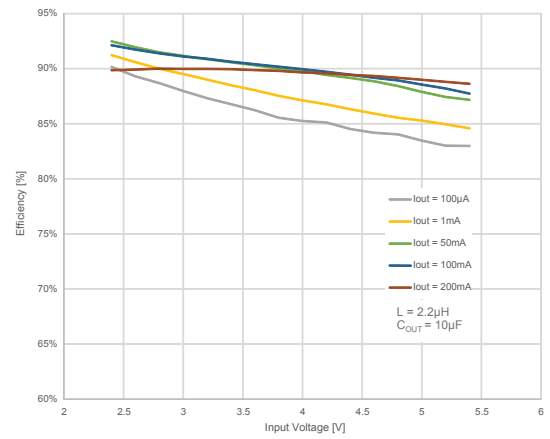

Figure 6. Efficiency vs load, $V_{OUT} = 3.3\text{ V}$

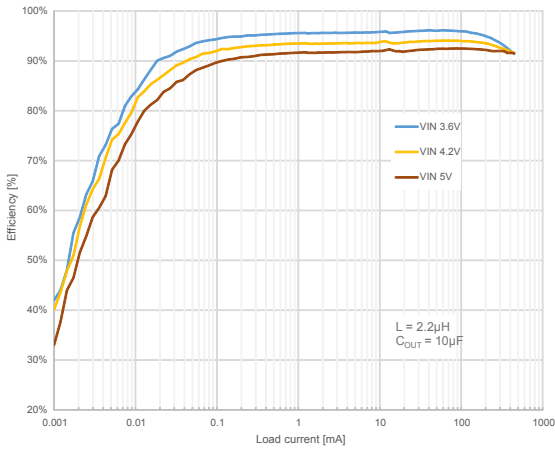

Figure 7. Efficiency vs V_{IN} , $V_{OUT} = 3.3\text{ V}$

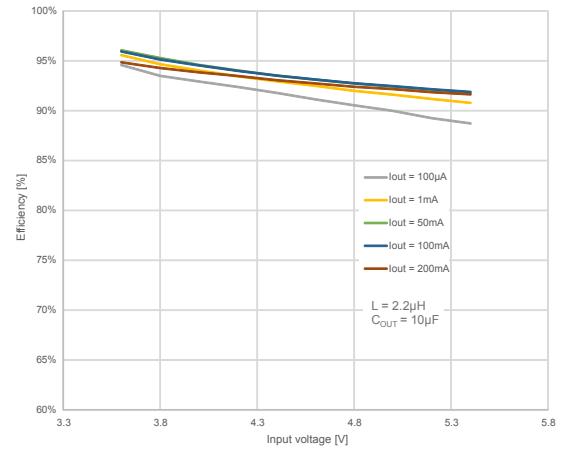

Figure 8. 100% mode, $V_{OUT} = 1.8\text{ V}$

Figure 9. 100% mode, $V_{OUT} = 3.0\text{ V}$

Figure 10. V_{OUT} change, 1.8 V to 3.3 V to 1.8 V, $I_{OUT}=5\text{ mA}$

Figure 11. Output ripple, $V_{IN}=3.6\text{ V}$, $V_{OUT}=1.8\text{ V}$, $I_{OUT}=10\text{ }\mu\text{A}$

Figure 12. Output ripple, $V_{IN}=3.6\text{ V}$, $V_{OUT}=1.8\text{ V}$, $I_{OUT}=10\text{ mA}$

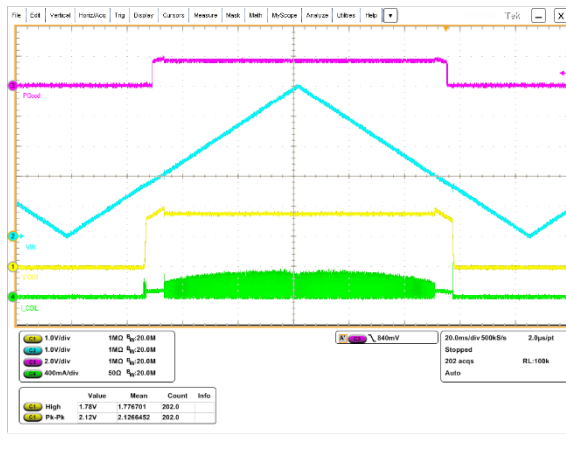
Figure 13. Output ripple, $V_{IN}=3.6\text{ V}$, $V_{OUT}=1.8\text{ V}$, $I_{OUT}=50\text{ mA}$

Figure 14. Output ripple, $V_{IN}=3.6\text{ V}$, $V_{OUT}=1.8\text{ V}$, $I_{OUT}=150\text{ mA}$

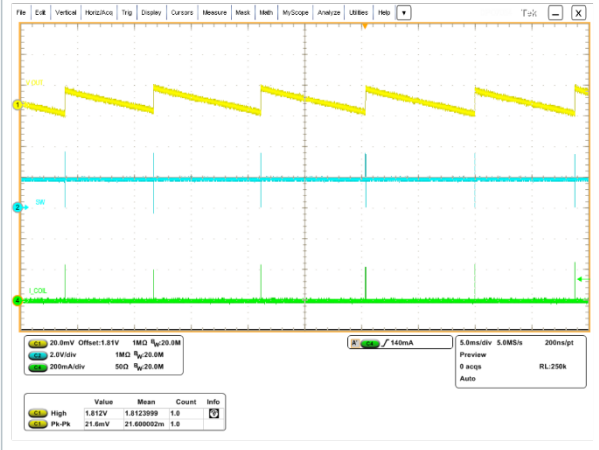
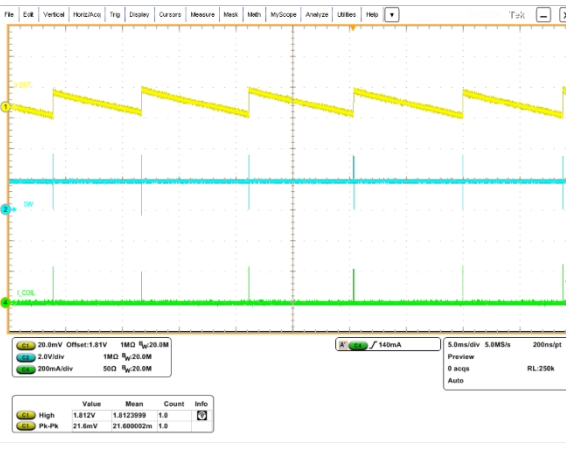
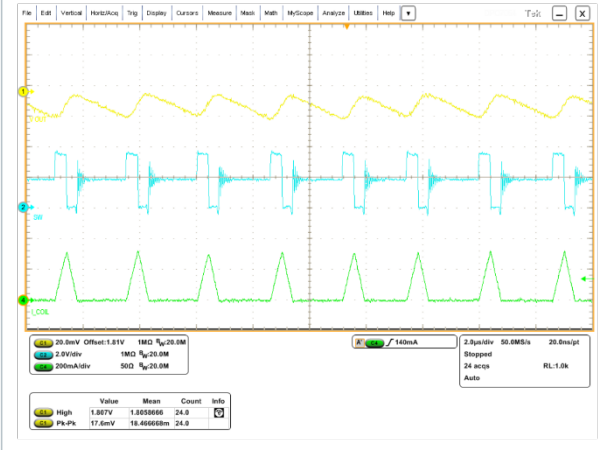
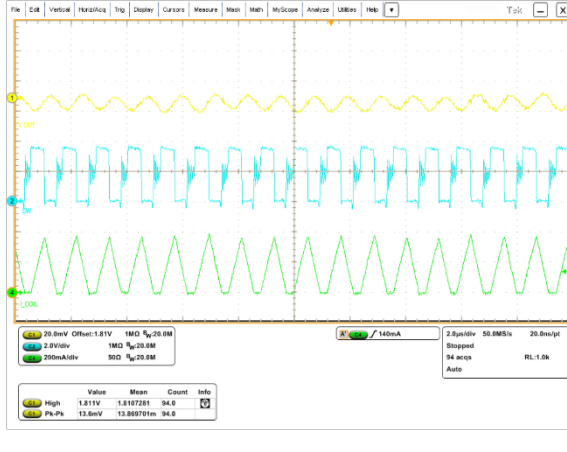

Figure 15. Output ripple, $V_{IN}=3.6\text{ V}$, $V_{OUT}=1.8\text{ V}$, $I_{OUT}=250\text{ mA}$

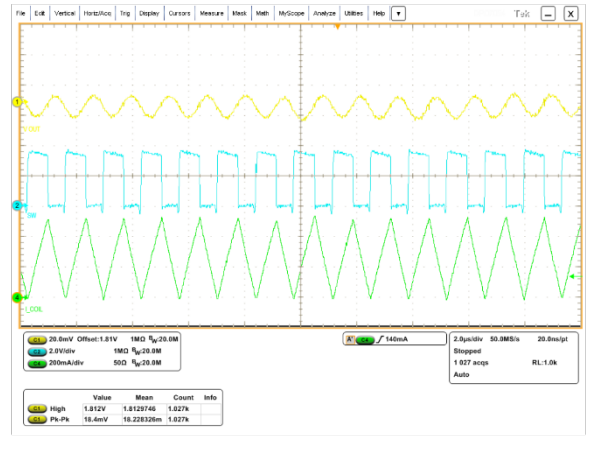

Figure 16. Start-up, $V_{IN}=3.6\text{ V}$, $V_{OUT}=1.8\text{ V}$, no load



Figure 17. Disable, $V_{IN}=3.6\text{ V}$, $V_{OUT}=1.8\text{ V}$, no load

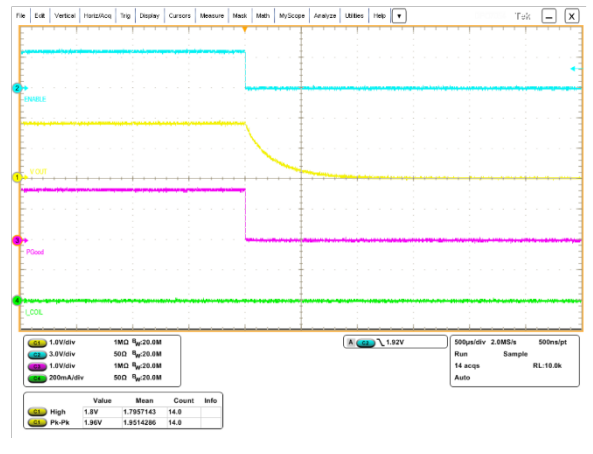

Figure 18. Start-up, $V_{IN}=3.6\text{ V}$, $V_{OUT}=1.8\text{ V}$, $I_{OUT}=100\text{ mA}$

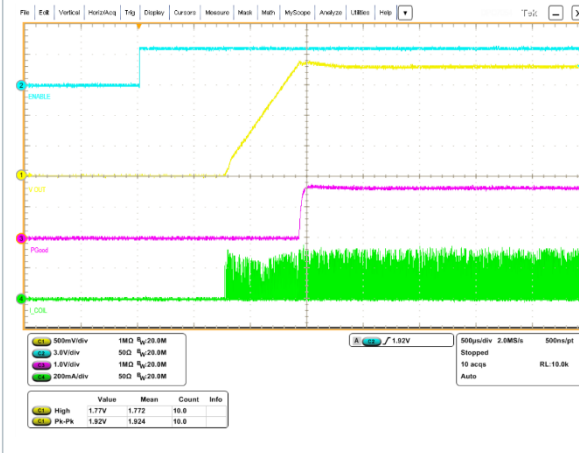
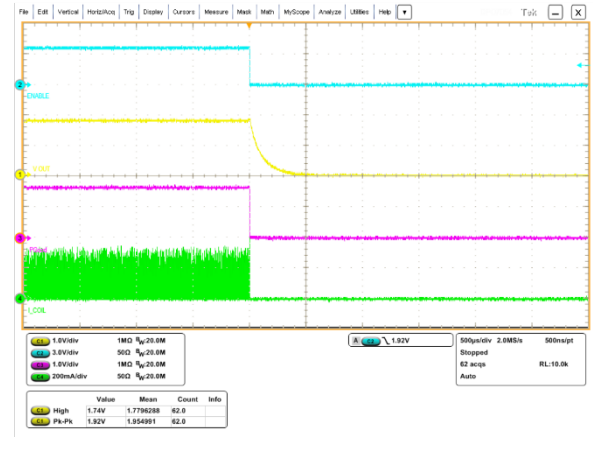

Figure 19. Disable, $V_{IN}=3.6\text{ V}$, $V_{OUT}=1.8\text{ V}$, $I_{OUT}=100\text{ mA}$



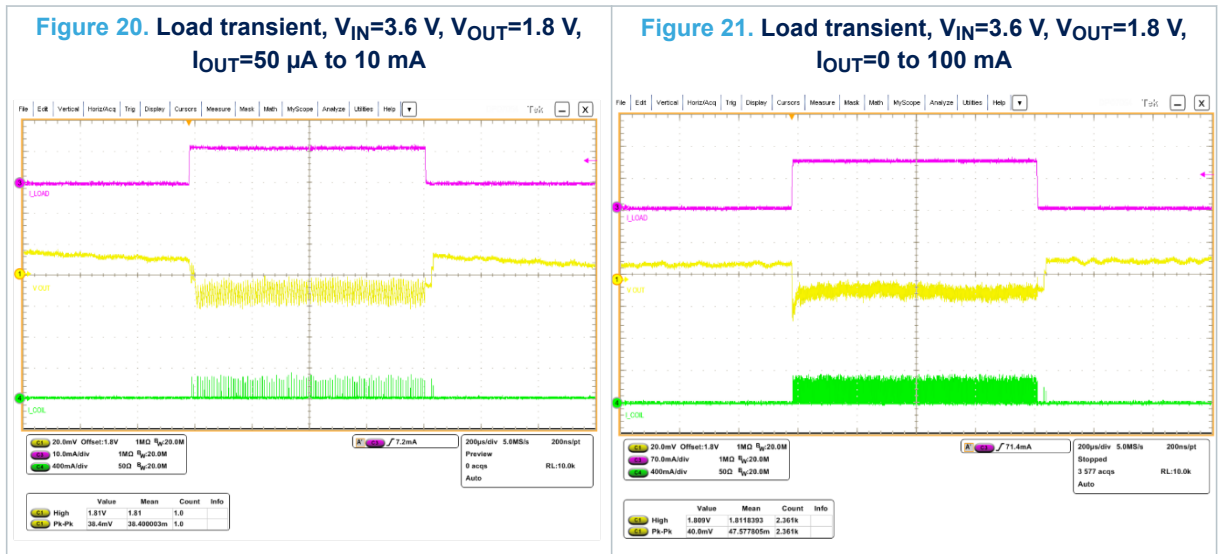
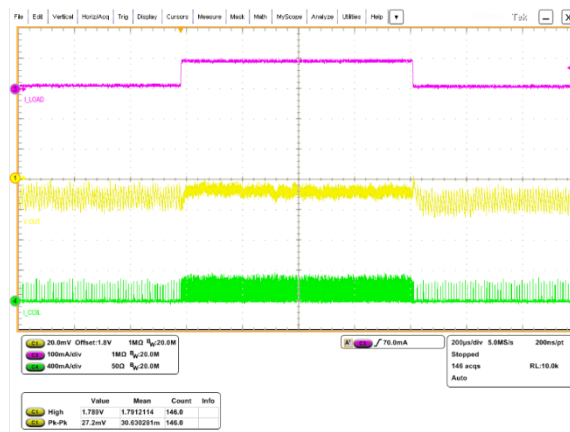

Figure 22. Load transient, $V_{IN}=3.6\text{ V}$, $V_{OUT}=1.8\text{ V}$, $I_{OUT}=10$ to 100 mA



9 Package information

In order to meet environmental requirements, ST offers these devices in different grades of **ECOPACK** packages, depending on their level of environmental compliance. ECOPACK specifications, grade definitions and product status are available at: www.st.com. ECOPACK is an ST trademark.

9.1 Flip-Chip 8 (1.14x1.44 mm) package information

Figure 23. Flip-Chip 8 (1.14x1.44 mm) package outline

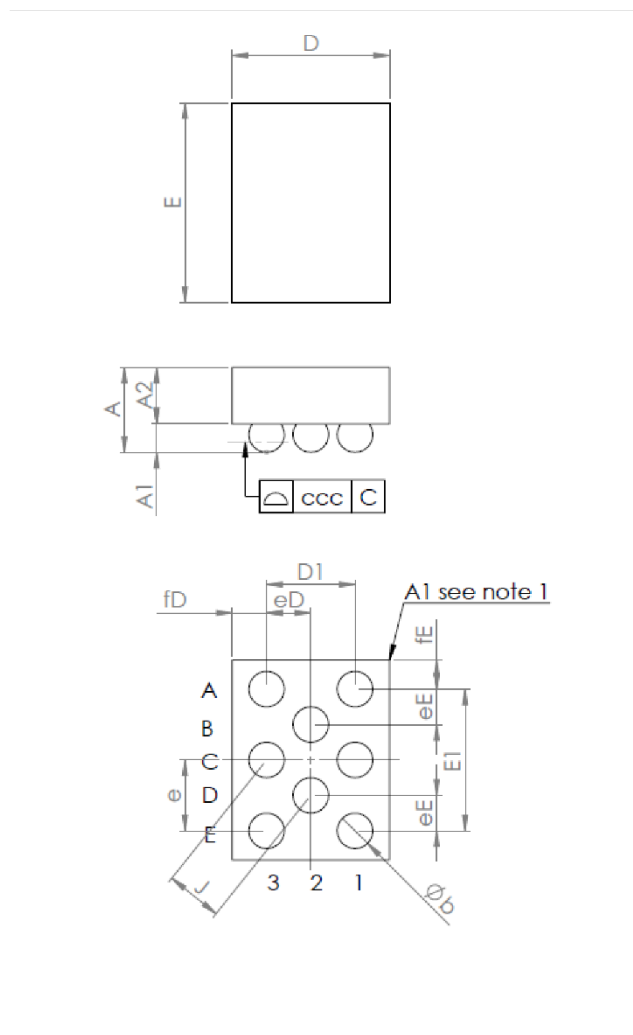
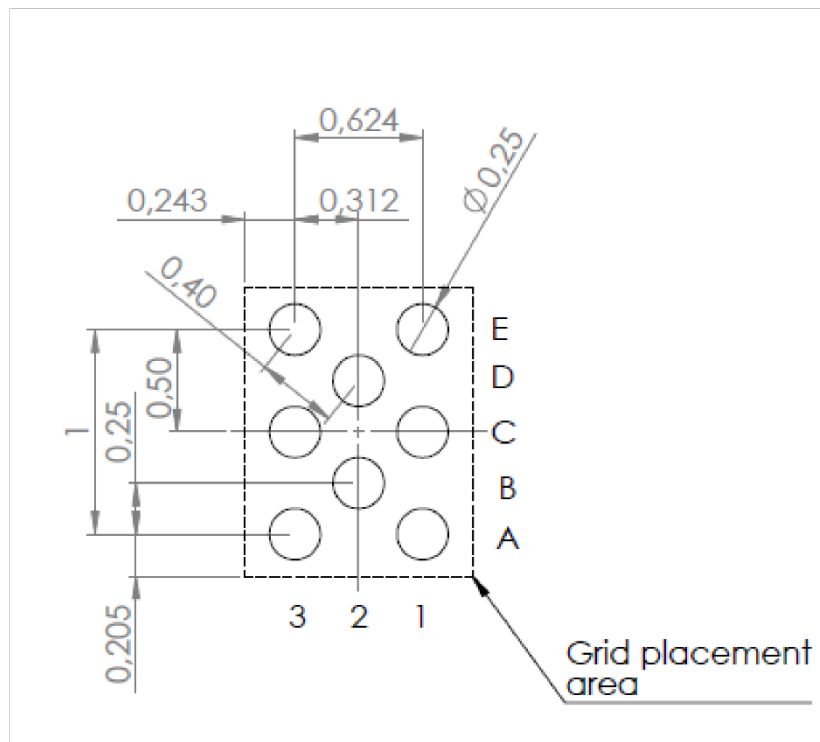

Table 8. Flip-Chip 8 (1.14x1.44 mm) mechanical data

Symbol	Millimeters		
	Min.	Typ.	Max.
A	0.500	0.550	0.600
A1	0.170	0.200	0.230
A2	0.330	0.350	0.370
b	0.230	0.250	0.270
D	1.08	1.11	1.14
D1		0.624	
E	1.38	1.41	1.44
E1		1.00	
fE		0.205	
fD		0.243	
eE		0.250	
eD		0.312	
e		0.50	
J		0.40	
ccc		0.05	

Figure 24. Flip-Chip 8 (1.14x1.44 mm) recommended footprint

9.2 Flip-Chip 8 (1.14x1.44 mm) packing information

Figure 25. Flip-Chip 8 (1.14x1.44 mm) tape outline

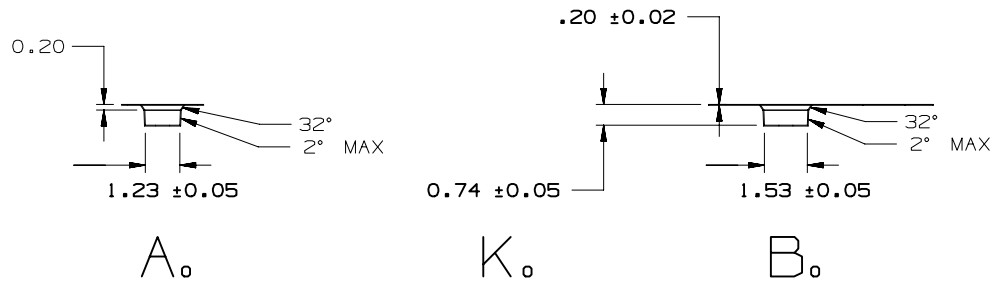
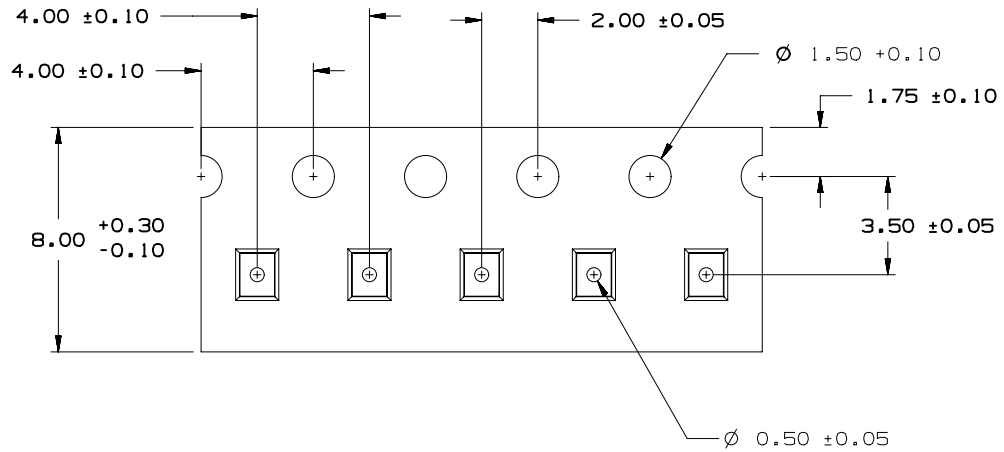

Figure 26. Flip-Chip 8 (1.14x1.44 mm) tape orientation

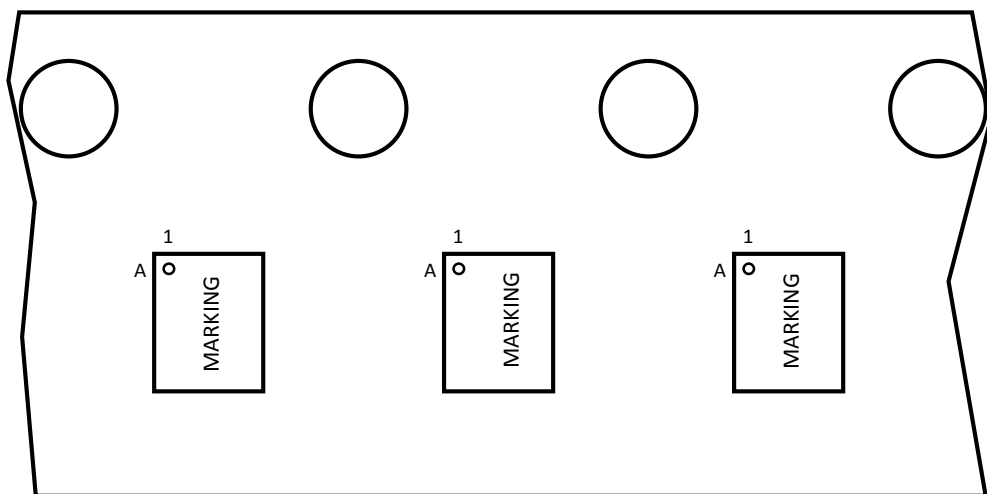

Figure 27. Flip-Chip 8 (1.14x1.44 mm) reel outline

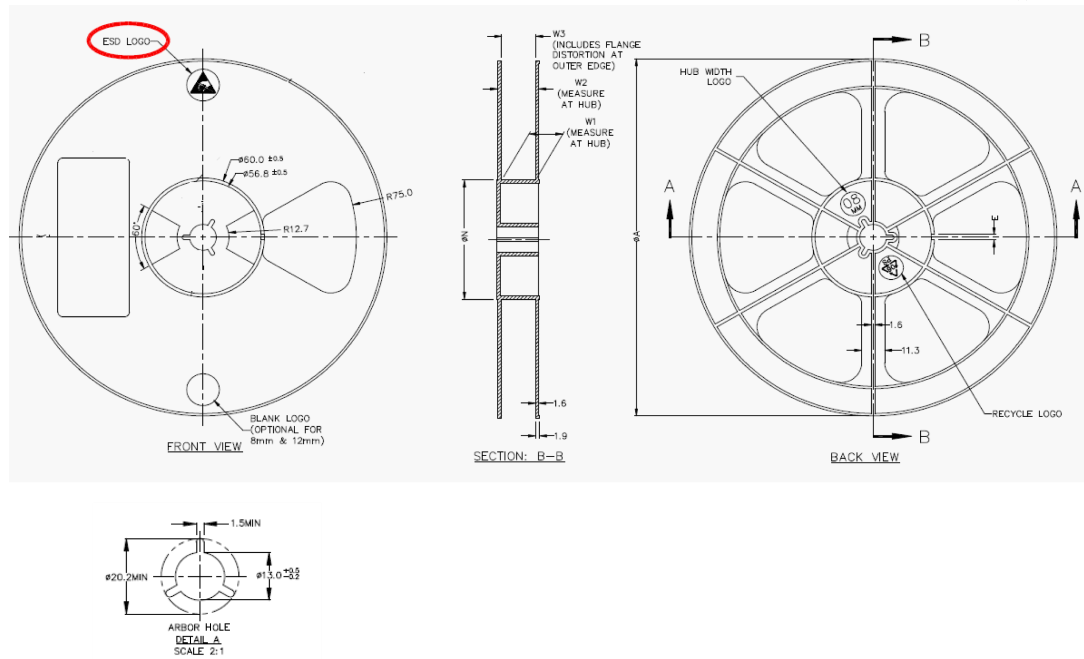

Table 9. Reel mechanical data

A max.	N min.	W1 max. [mm]	W2 max. [mm]	W3 min./max. [mm]
180	60	8.4	14.4	7.9/10.9

Revision history

Table 10. Document revision history

Date	Version	Changes
31-Oct-2018	1	Initial release.
13-Dec-2018	2	Updated Section 8 Typical performance characteristics. Added Section 9.2 Flip-Chip 8 (1.14x1.44 mm) packing information.
13-Dec-2019	3	Updated Figure 22. Load transient, $V_{IN}=3.6\text{ V}$, $V_{OUT}=1.8\text{ V}$, $I_{OUT}= 10\text{ to }100\text{ mA}$.

Contents

1	Application schematic	2
2	Pin configuration (top through view)	3
3	Functional pin description	4
4	Maximum ratings	5
5	Electrical characteristics	6
6	Block diagram	8
7	Operation description	9
7.1	Power save mode	9
7.2	Output voltage	9
7.3	Output discharge and UVLO	9
7.4	Soft-start and current limitation	9
7.5	100% duty cycle operation	9
7.6	Power Good flag	9
8	Typical performance characteristics	10
9	Package information	14
9.1	Flip-Chip8 (1.14x1.44 mm) package information	14
9.2	Flip-Chip 8 (1.14x1.44 mm) packing information	15
	Revision history	18

IMPORTANT NOTICE – PLEASE READ CAREFULLY

STMicroelectronics NV and its subsidiaries (“ST”) reserve the right to make changes, corrections, enhancements, modifications, and improvements to ST products and/or to this document at any time without notice. Purchasers should obtain the latest relevant information on ST products before placing orders. ST products are sold pursuant to ST’s terms and conditions of sale in place at the time of order acknowledgement.

Purchasers are solely responsible for the choice, selection, and use of ST products and ST assumes no liability for application assistance or the design of Purchasers’ products.

No license, express or implied, to any intellectual property right is granted by ST herein.

Resale of ST products with provisions different from the information set forth herein shall void any warranty granted by ST for such product.

ST and the ST logo are trademarks of ST. For additional information about ST trademarks, please refer to www.st.com/trademarks. All other product or service names are the property of their respective owners.

Information in this document supersedes and replaces information previously supplied in any prior versions of this document.

© 2019 STMicroelectronics – All rights reserved

Компания «Океан Электроники» предлагает заключение долгосрочных отношений при поставках импортных электронных компонентов на взаимовыгодных условиях!

Наши преимущества:

- Поставка оригинальных импортных электронных компонентов напрямую с производств Америки, Европы и Азии, а так же с крупнейших складов мира;
- Широкая линейка поставок активных и пассивных импортных электронных компонентов (более 30 млн. наименований);
- Поставка сложных, дефицитных, либо снятых с производства позиций;
- Оперативные сроки поставки под заказ (от 5 рабочих дней);
- Экспресс доставка в любую точку России;
- Помощь Конструкторского Отдела и консультации квалифицированных инженеров;
- Техническая поддержка проекта, помощь в подборе аналогов, поставка прототипов;
- Поставка электронных компонентов под контролем ВП;
- Система менеджмента качества сертифицирована по Международному стандарту ISO 9001;
- При необходимости вся продукция военного и аэрокосмического назначения проходит испытания и сертификацию в лаборатории (по согласованию с заказчиком);
- Поставка специализированных компонентов военного и аэрокосмического уровня качества (Xilinx, Altera, Analog Devices, Intersil, Interpoint, Microsemi, Actel, Aeroflex, Peregrine, VPT, Syfer, Eurofarad, Texas Instruments, MS Kennedy, Miteq, Cobham, E2V, MA-COM, Hittite, Mini-Circuits, General Dynamics и др.);

Компания «Океан Электроники» является официальным дистрибьютором и эксклюзивным представителем в России одного из крупнейших производителей разъемов военного и аэрокосмического назначения «JONHON», а так же официальным дистрибьютором и эксклюзивным представителем в России производителя высокотехнологичных и надежных решений для передачи СВЧ сигналов «FORSTAR».



JONHON

«JONHON» (основан в 1970 г.)

Разъемы специального, военного и аэрокосмического назначения:

(Применяются в военной, авиационной, аэрокосмической, морской, железнодорожной, горно- и нефтедобывающей отраслях промышленности)

«FORSTAR» (основан в 1998 г.)

ВЧ соединители, коаксиальные кабели, кабельные сборки и микроволновые компоненты:

(Применяются в телекоммуникациях гражданского и специального назначения, в средствах связи, РЛС, а так же военной, авиационной и аэрокосмической отраслях промышленности).



Телефон: 8 (812) 309-75-97 (многоканальный)

Факс: 8 (812) 320-03-32

Электронная почта: ocean@oceanchips.ru

Web: <http://oceanchips.ru/>

Адрес: 198099, г. Санкт-Петербург, ул. Калинина, д. 2, корп. 4, лит. А