

799-015
Low Profile EMI Backshell
for 790-024 and 790-025 Cable Connectors
How To Order







799-015 Low Profile EMI Backshell
FOR 790-024 AND 790-025 CABLE CONNECTORS

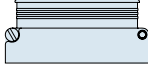

Attach cable braid to connector with 799-015 adapters. These adapters fit securely into a groove on 790-024 and 790-025 cable connectors. Terminate shields with **BAND-IT**® 300 Series SST/Passivate I.A.W. AMS 2700. Elliptical cable entry provides room for large wire bundles. Machined T6061 aluminum adapters consist of two interlocking housings, two fillister head screws and two lockwashers. These lightweight, space-saving adapters are compatible with captive screws on connector flange. This adapter is non environmental. Fill with potting compound to prevent water intrusion.

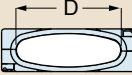
How To Order

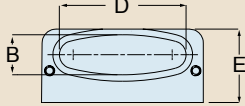
How To Order																																																									
Sample Part Number																																																									
799-015T	M	B	02	N	02																																																				
Part Number	Shell Finish	Shell Size	Cable Entry Size	Band Option	Optional Height Code*																																																				
 799-015T Top Entry  799-015S Side Entry	M Electroless Nickel <i>general purpose applications</i> MT Nickel-PTFE 1000 Hour Grey™ <i>maximum corrosion protection and durability (non-reflective grey)</i>	A		N No Band Supplied M BAND-IT ™ Micro-Band Included. .125 (3.18) Wide. 	 <table border="1"> <thead> <tr> <th rowspan="2">Height Code</th> <th colspan="2">E</th> </tr> <tr> <th>In.</th> <th>mm.</th> </tr> </thead> <tbody> <tr><td>01</td><td>.810</td><td>20.6</td></tr> <tr><td>02</td><td>.940</td><td>23.9</td></tr> <tr><td>03</td><td>1.060</td><td>26.9</td></tr> <tr><td>04</td><td>1.190</td><td>30.2</td></tr> <tr><td>05</td><td>1.310</td><td>33.3</td></tr> <tr><td>06</td><td>1.440</td><td>36.6</td></tr> <tr><td>07</td><td>1.560</td><td>39.6</td></tr> <tr><td>08</td><td>1.690</td><td>42.9</td></tr> <tr><td>09</td><td>1.810</td><td>46.0</td></tr> <tr><td>10</td><td>1.940</td><td>49.3</td></tr> <tr><td>Omit</td><td>.690</td><td>17.5</td></tr> </tbody> </table>	Height Code	E		In.	mm.	01	.810	20.6	02	.940	23.9	03	1.060	26.9	04	1.190	30.2	05	1.310	33.3	06	1.440	36.6	07	1.560	39.6	08	1.690	42.9	09	1.810	46.0	10	1.940	49.3	Omit	.690	17.5														
		Height Code	E																																																						
			In.			mm.																																																			
		01	.810			20.6																																																			
		02	.940			23.9																																																			
		03	1.060			26.9																																																			
	04	1.190	30.2																																																						
	05	1.310	33.3																																																						
	06	1.440	36.6																																																						
	07	1.560	39.6																																																						
	08	1.690	42.9																																																						
	09	1.810	46.0																																																						
10	1.940	49.3																																																							
Omit	.690	17.5																																																							
ZNU Zinc-Nickel with Black Chromate <i>tactical applications (non-reflective black)</i> Additional shell finishes are listed on page C-9.	B	D	<table border="1"> <thead> <tr> <th rowspan="2">Cable Entry Code</th> <th colspan="2">D</th> <th rowspan="2">Shell Size</th> </tr> <tr> <th>In.</th> <th>mm.</th> </tr> </thead> <tbody> <tr><td>01</td><td>.140</td><td>3.56</td><td>A-M</td></tr> <tr><td>02</td><td>.290</td><td>7.37</td><td>B-M</td></tr> <tr><td>03</td><td>.440</td><td>11.18</td><td>C-M</td></tr> <tr><td>04</td><td>.540</td><td>13.72</td><td>D-M</td></tr> <tr><td>05</td><td>.690</td><td>17.53</td><td>E-M</td></tr> <tr><td>06</td><td>.810</td><td>20.57</td><td>F-M</td></tr> <tr><td>07</td><td>1.000</td><td>25.40</td><td>H-M</td></tr> <tr><td>08</td><td>1.190</td><td>30.23</td><td>H-M</td></tr> <tr><td>09</td><td>1.305</td><td>33.15</td><td>K-M</td></tr> <tr><td>10</td><td>1.420</td><td>36.07</td><td>K-M</td></tr> <tr><td>11</td><td>1.600</td><td>40.64</td><td>K</td></tr> <tr><td>12</td><td>1.500</td><td>38.10</td><td>K and M</td></tr> </tbody> </table>	Cable Entry Code	D		Shell Size	In.	mm.	01	.140	3.56	A-M	02	.290	7.37	B-M	03	.440	11.18	C-M	04	.540	13.72	D-M	05	.690	17.53	E-M	06	.810	20.57	F-M	07	1.000	25.40	H-M	08	1.190	30.23	H-M	09	1.305	33.15	K-M	10	1.420	36.07	K-M	11	1.600	40.64	K	12	1.500	38.10	K and M
	Cable Entry Code	D			Shell Size																																																				
		In.		mm.																																																					
	01	.140		3.56	A-M																																																				
	02	.290		7.37	B-M																																																				
	03	.440		11.18	C-M																																																				
04	.540	13.72	D-M																																																						
05	.690	17.53	E-M																																																						
06	.810	20.57	F-M																																																						
07	1.000	25.40	H-M																																																						
08	1.190	30.23	H-M																																																						
09	1.305	33.15	K-M																																																						
10	1.420	36.07	K-M																																																						
11	1.600	40.64	K																																																						
12	1.500	38.10	K and M																																																						
C	D	E																																																							
F	G	H																																																							
J	K	L																																																							
M																																																									

* For Top Entry Style T, shortest height code of E = .69" is limited to shell & entry size combinations A01, B02, C03, D04, E05, F06, G06, H08, J08, K11, L10 & M12 to ensure adequate wire clearance. Contact factory for other combinations. For Side Entry Style S, shortest height code E is acceptable for all shell & entry size combinations except consideration for 12AWG wire bend radius.

Dimensions in Inches (millimeters) are subject to change without notice.





799-015
Low Profile EMI Backshell
for 790-024 and 790-025 Cable Connectors
How To Order

799-015 Low Profile EMI Backshell

STYLE T - TOP ENTRY

STYLE S - SIDE ENTRY

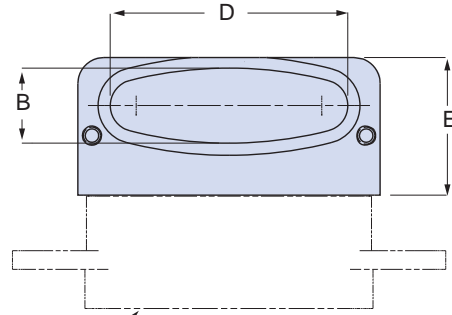
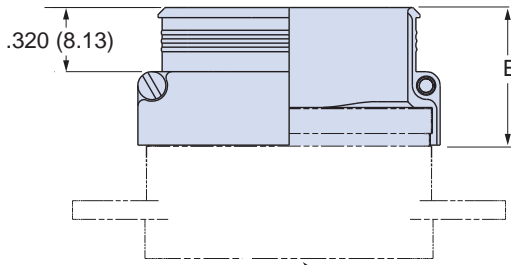
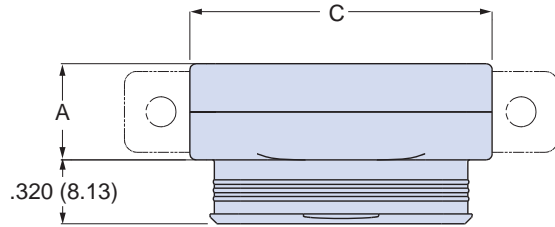
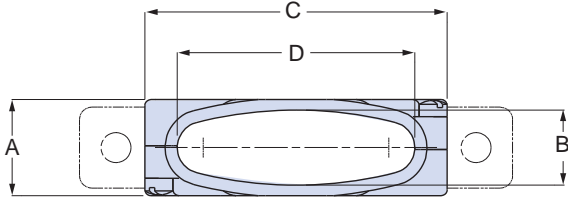

CONNECTOR SHOWN FOR REFERENCE - NOT SUPPLIED

799-015 DIMENSIONS

Shell Size	A Max.		B		C Max.		Available Entries
	In.	mm.	In.	mm.	In.	mm.	
A	.385	9.78	.270	6.86	.485	12.32	01
B	.385	9.78	.270	6.86	.635	16.13	01 thru 02
C	.385	9.78	.270	6.86	.785	19.94	01 thru 03
D	.385	9.78	.270	6.86	.885	22.48	01 thru 04
E	.385	9.78	.270	6.86	1.035	26.29	01 thru 05
F	.385	9.78	.270	6.86	1.185	30.10	01 thru 06
G	.465	11.81	.350	8.89	1.145	29.08	01 thru 06
H	.495	12.57	.380	9.65	1.525	38.74	01 thru 08
J	.385	9.78	.270	6.86	1.545	39.24	01 thru 08
K	.385	9.78	.270	6.86	1.945	49.40	01 thru 11
L	.495	12.57	.380	9.65	1.765	44.83	01 thru 10
M	.555		.440		1.830		01 thru 10, 12

ENTRY SIZE

Entry Size	D		Available Sizes
	In.	mm.	
01	.140	3.56	A Thru L
02	.290	7.37	B thru L
03	.440	11.18	C thru L
04	.540	13.72	D thru L
05	.690	17.53	E thru L
06	.810	20.57	F, H, J, K, L
07	1.000	25.40	H thru L
08	1.190	30.23	H Thru L
09	1.305	33.15	K, L
10	1.420	36.07	K, L
11	1.600	40.64	K
12	1.500	38.10	K and M

HEIGHT CODE

CODE	E	
	In.	mm.
01	.810	20.6
02	.940	23.9
03	1.060	26.9
04	1.190	30.2
05	1.310	33.3
06	1.440	36.6
07	1.560	39.6
08	1.690	42.9
09	1.810	46.0
10	1.940	49.3
11	1.600	40.6
12	1.500	38.1

Component	Material	Finish
Backshell	Aluminum Alloy	See table below
Hardware	Stainless Steel	Passivated

Dimensions in Inches (millimeters) are subject to change without notice.

Компания «Океан Электроники» предлагает заключение долгосрочных отношений при поставках импортных электронных компонентов на взаимовыгодных условиях!

Наши преимущества:

- Поставка оригинальных импортных электронных компонентов напрямую с производств Америки, Европы и Азии, а так же с крупнейших складов мира;
- Широкая линейка поставок активных и пассивных импортных электронных компонентов (более 30 млн. наименований);
- Поставка сложных, дефицитных, либо снятых с производства позиций;
- Оперативные сроки поставки под заказ (от 5 рабочих дней);
- Экспресс доставка в любую точку России;
- Помощь Конструкторского Отдела и консультации квалифицированных инженеров;
- Техническая поддержка проекта, помощь в подборе аналогов, поставка прототипов;
- Поставка электронных компонентов под контролем ВП;
- Система менеджмента качества сертифицирована по Международному стандарту ISO 9001;
- При необходимости вся продукция военного и аэрокосмического назначения проходит испытания и сертификацию в лаборатории (по согласованию с заказчиком);
- Поставка специализированных компонентов военного и аэрокосмического уровня качества (Xilinx, Altera, Analog Devices, Intersil, Interpoint, Microsemi, Actel, Aeroflex, Peregrine, VPT, Syfer, Eurofarad, Texas Instruments, MS Kennedy, Miteq, Cobham, E2V, MA-COM, Hittite, Mini-Circuits, General Dynamics и др.);

Компания «Океан Электроники» является официальным дистрибьютором и эксклюзивным представителем в России одного из крупнейших производителей разъемов военного и аэрокосмического назначения «JONHON», а так же официальным дистрибьютором и эксклюзивным представителем в России производителя высокотехнологичных и надежных решений для передачи СВЧ сигналов «FORSTAR».



JONHON

«JONHON» (основан в 1970 г.)

Разъемы специального, военного и аэрокосмического назначения:

(Применяются в военной, авиационной, аэрокосмической, морской, железнодорожной, горно- и нефтедобывающей отраслях промышленности)

«FORSTAR» (основан в 1998 г.)

ВЧ соединители, коаксиальные кабели, кабельные сборки и микроволновые компоненты:

(Применяются в телекоммуникациях гражданского и специального назначения, в средствах связи, РЛС, а так же военной, авиационной и аэрокосмической отраслях промышленности).



Телефон: 8 (812) 309-75-97 (многоканальный)

Факс: 8 (812) 320-03-32

Электронная почта: ocean@oceanchips.ru

Web: <http://oceanchips.ru/>

Адрес: 198099, г. Санкт-Петербург, ул. Калинина, д. 2, корп. 4, лит. А