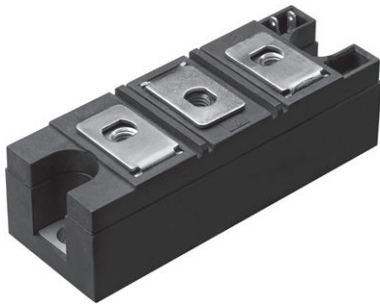

## INT-A-PAK Power Module Thyristor/Diode, 300 A

**INT-A-PAK**

### FEATURES

- Electrically isolated base plate
- 3000 V<sub>RMS</sub> isolating voltage
- Industrial standard package
- Simplified mechanical designs, rapid assembly
- High surge capability
- Large creepage distances
- UL approved file E78996
- Material categorization: For definitions of compliance please see [www.vishay.com/doc?99912](http://www.vishay.com/doc?99912)

**RoHS**  
COMPLIANT

### APPLICATIONS

- Battery chargers
- Welders
- Power converters
- Alternators

### PRODUCT SUMMARY

$I_{T(AV)}$	300 A
Type	Modules - Thyristor, Standard
Package	INT-A-PAK
Circuit	SCR/diode doubler circuit, negative control

### MAJOR RATINGS AND CHARACTERISTICS

SYMBOL	CHARACTERISTICS	VALUES	UNITS
$V_{DRM}/V_{RRM}$		800	V
$I_{T(AV)}$	53 °C	300	A
$I_{TSM}$	50 Hz	6500	A
	60 Hz	6900	
$I^2t$	50 Hz	214	kA <sup>2</sup> s
	60 Hz	195	
$I^2\sqrt{t}$		2140	kA <sup>2</sup> √s
$T_J$	Range	-40 to 140	°C

### ELECTRICAL SPECIFICATIONS

#### VOLTAGE RATINGS

TYPE NUMBER	$V_{RRM}/V_{DRM}$ , MAXIMUM REPETITIVE PEAK REVERSE VOLTAGE V	$V_{RSM}/V_{DSM}$ , MAXIMUM NON-REPETITIVE PEAK REVERSE VOLTAGE V	$I_{RRM}/I_{DRM}$ AT 125 °C mA
VS-VSKL300/08PbF	800	900	50



ON-STATE CONDUCTION					
PARAMETER	SYMBOL	TEST CONDITIONS		VALUES	UNITS
Maximum average on-state current at case temperature	$I_{T(AV)}$	180° conduction half sine wave		300	A
				53	°C
Maximum RMS on-state current	$I_{T(RMS)}$	As AC switch		116	A
Maximum peak, one-cycle on-state, non-repetitive surge current	$I_{TSM}$	t = 10 ms	No voltage reappplied	6600	
		t = 8.3 ms		6900	
		t = 10 ms	100 % $V_{RRM}$ reappplied	5500	
		t = 8.3 ms		5800	
Maximum $I^2t$ for fusing	$I^2t$	t = 10 ms	No voltage reappplied	214	kA <sup>2</sup> s
		t = 8.3 ms		195	
		t = 10 ms	100 % $V_{RRM}$ reappplied	151	
		t = 8.3 ms		138	
Maximum $I^2\sqrt{t}$ for fusing	$I^2\sqrt{t}$	t = 0.1 ms to 10 ms, no voltage reappplied		2140	kA <sup>2</sup> √s
Low level value of threshold voltage	$V_{T(TO)1}$	(16.7 % $\times \pi \times I_{T(AV)} < I < \pi \times I_{T(AV)}$ ), $T_J$ maximum		0.796	V
High level value of threshold voltage	$V_{T(TO)2}$	(I > $\pi \times I_{T(AV)}$ ), $T_J$ maximum		0.868	
Low level value on-state slope resistance	$r_{t1}$	(16.7 % $\times \pi \times I_{T(AV)} < I < \pi \times I_{T(AV)}$ ), $T_J$ maximum		0.972	mΩ
High level value on-state slope resistance	$r_{t2}$	(I > $\pi \times I_{T(AV)}$ ), $T_J$ maximum		0.88	
Maximum on-state voltage drop	$V_{TM}$	$T_J = 25\text{ °C}$ , 500 A $I_{pk}$	SCR	1.35	V
	$V_{FM}$		DIODE	1.20	

SWITCHING					
PARAMETER	SYMBOL	TEST CONDITIONS		VALUES	UNITS
Typical delay time	$t_d$	Gate current 1 A, $dI_g/dt = 1\text{ A}/\mu\text{s}$ $V_d = 0.67\% V_{DRM}$ , $T_J = 25\text{ °C}$		1.0	μs
Typical turn-off time	$t_q$	$I_{TM} = 300\text{ A}$ , $T_J = T_J$ maximum, $dI/dt = 20\text{ A}/\mu\text{s}$ , $V_R = 50\text{ V}$ $dV/dt = 20\text{ V}/\mu\text{s}$ , Gate 0 V 100 Ω, $t_p = 500\text{ μs}$		100	

BLOCKING					
PARAMETER	SYMBOL	TEST CONDITIONS		VALUES	UNITS
Maximum critical rate of rise of off-state voltage	$dV/dt$	$T_J = T_J$ maximum linear to 67 % rated $V_{DRM}$		500	V/μs
Maximum peak reverse and off-state leakage current	$I_{DRM}$ , $I_{RRM}$	$T_J = T_J$ maximum, rated $V_{DRM}/V_{RRM}$ applied		50	mA
RMS insulation voltage	$V_{INS}$	50 Hz, circuit to base, all terminal shorted, t = 1 s		3000	V



<b>TRIGGERING</b>				
PARAMETER	SYMBOL	TEST CONDITIONS	VALUES	UNITS
Maximum peak gate power	$P_{GM}$	$T_J = T_J$ maximum, $t_p \leq 5$ ms	10.0	W
Maximum average gate power	$P_{G(AV)}$	$T_J = T_J$ maximum, $f = 50$ Hz, $d\% = 50$	2.0	
Maximum peak positive gate current	$I_{GM}$	$T_J = T_J$ maximum, $t_p \leq 5$ ms	3.0	A
Maximum required DC gate voltage to trigger	$V_{GT}$	$T_J = 25$ °C Anode supply: 12 V resistive load	3	V
Maximum required DC gate current to trigger	$I_{GT}$		200	mA
Maximum holding current	$I_H$		600	
Maximum peak positive gate voltage	$+V_{GM}$	$T_J = T_J$ maximum, $t_p \leq 5$ ms	20	V
Maximum peak negative gate voltage	$-V_{GM}$		5.0	
DC gate voltage not to trigger	$V_{GD}$	$T_J = T_J$ maximum Maximum gate current/voltage not to trigger is the maximum value which will not trigger any unit with rated $V_{DRM}$ anode to cathode applied	0.30	V
DC gate current not to trigger	$I_{GD}$		10	mA
Maximum non-repetitive rate of rise of turned-on current	$di/dt$	Gate drive 20 V, 20 $\Omega$ , $t_r \leq 1$ $\mu$ s $T_J = T_J$ maximum, anode voltage $\leq 80\%$ $V_{DRM}$	1000	A/ $\mu$ s

<b>THERMAL AND MECHANICAL SPECIFICATIONS</b>				
PARAMETER	SYMBOL	TEST CONDITIONS	VALUES	UNITS
Maximum junction operating temperature range	$T_J$		-40 to 140	°C
Maximum storage temperature range	$T_{Stg}$		-40 to 150	
Maximum thermal resistance, junction to case per junction	$R_{thJC}$	DC operation	0.19	K/W
Maximum thermal resistance, case to heatsink per module	$R_{thCS}$	Mounting surface smooth, flat and greased	0.035	
Mounting torque $\pm 10\%$	IAP to heatsink	A mounting compound is recommended and the torque should be rechecked after a period of 3 hours to allow for the spread of the compound. Lubricated threads.	4 to 6	Nm
	busbar to IAP			
Approximate weight			500	g
			17.8	oz.
Case style				INT-A-PAK

<b><math>\Delta R</math> CONDUCTION PER JUNCTION</b>											
DEVICES	SINUSOIDAL CONDUCTION AT $T_J$ MAXIMUM					RECTANGULAR CONDUCTION AT $T_J$ MAXIMUM					UNITS
	180°	120°	90°	60°	30°	180°	120°	90°	60°	30°	
VSKL300	0.019	0.022	0.028	0.041	0.068	0.013	0.023	0.031	0.043	0.069	K/W

**Note**

- Table shows the increment of thermal resistance  $R_{thJC}$  when devices operate at different conduction angles than DC

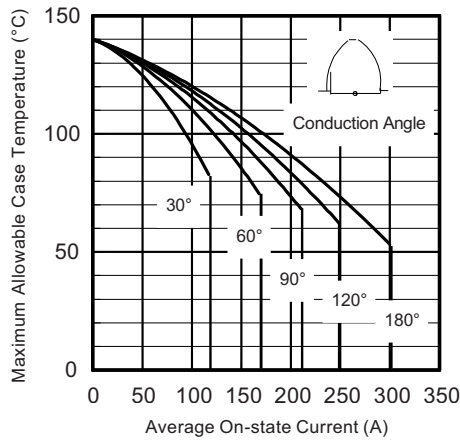

Fig. 1 - Current Ratings Characteristics

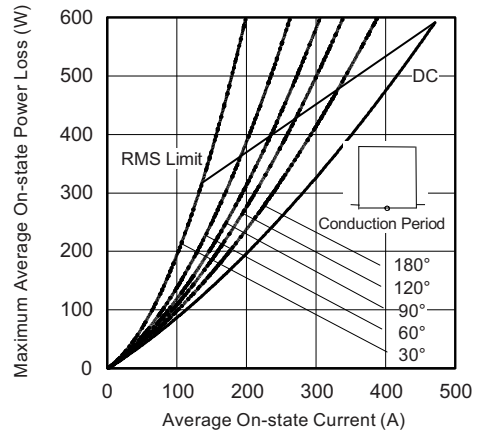

Fig. 4 - On-State Power Loss Characteristics

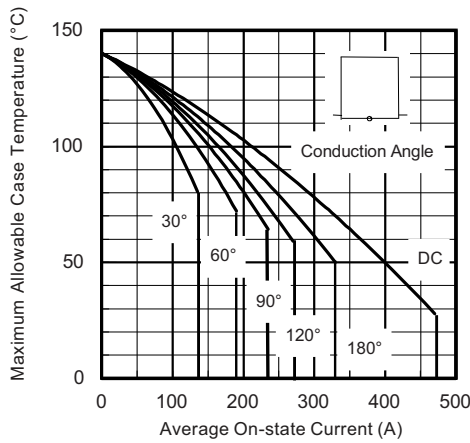

Fig. 2 - Current Ratings Characteristics

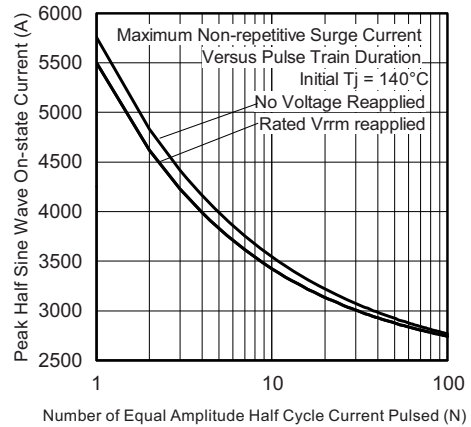

Fig. 5 - Maximum Non-Repetitive Surge Current

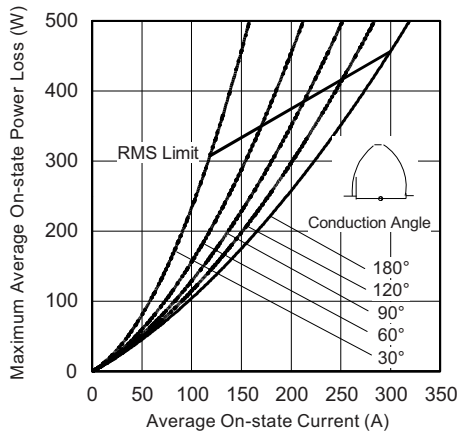

Fig. 3 - On-State Power Loss Characteristics

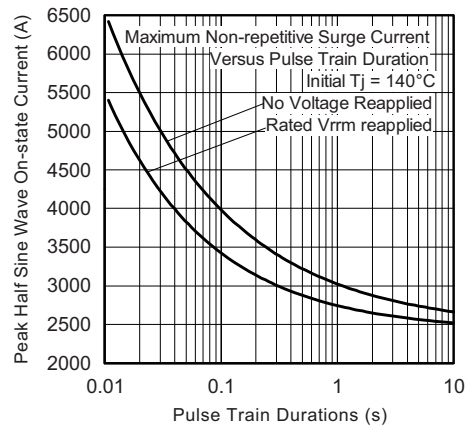

Fig. 6 - Maximum Non-Repetitive Surge Current

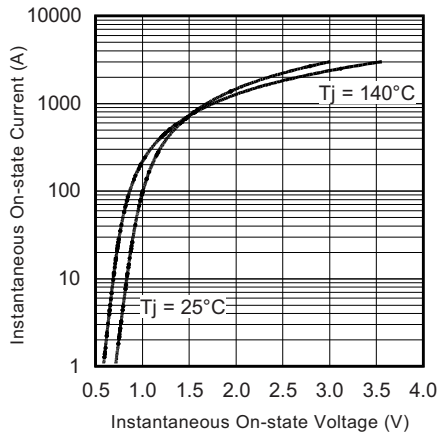

Fig. 7 - On-State Voltage Drop Characteristics (SCR)

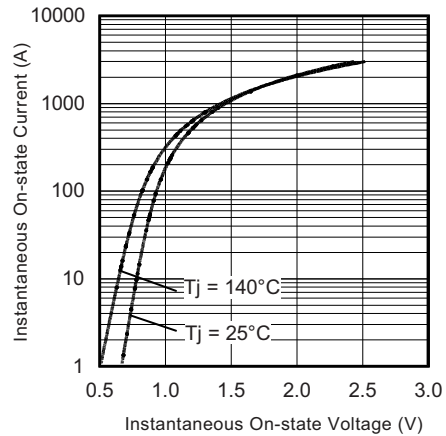

Fig. 8 - On-State Voltage Drop Characteristics (Diode)

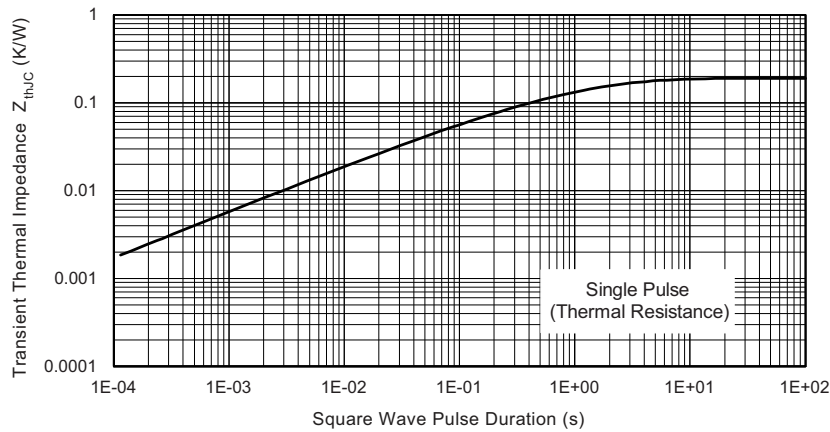

Fig. 9 - Thermal Impedance  $Z_{thJC}$  Characteristics

**ORDERING INFORMATION TABLE**

Device code	<b>VS-VS</b>	<b>KL</b>	<b>300</b>	<b>08</b>	<b>PbF</b>
	①	②	③	④	⑤
	<b>1</b>	-	Vishay Semiconductors product		
	<b>2</b>	-	Circuit configuration		
	<b>3</b>	-	Current rating (300 = 300 A)		
	<b>4</b>	-	Voltage rating (08 = 800 V)		
	<b>5</b>	-	PbF = Lead (Pb)-free		



CIRCUIT CONFIGURATION		
CIRCUIT DESCRIPTION	CIRCUIT CONFIGURATION CODE	CIRCUIT DRAWING
SCR/diode doubler circuit, negative control	L	

LINKS TO RELATED DOCUMENTS	
Dimensions	<a href="http://www.vishay.com/doc?95010">www.vishay.com/doc?95010</a>

## INT-A-PAK Diode

**DIMENSIONS** in millimeters (inches)

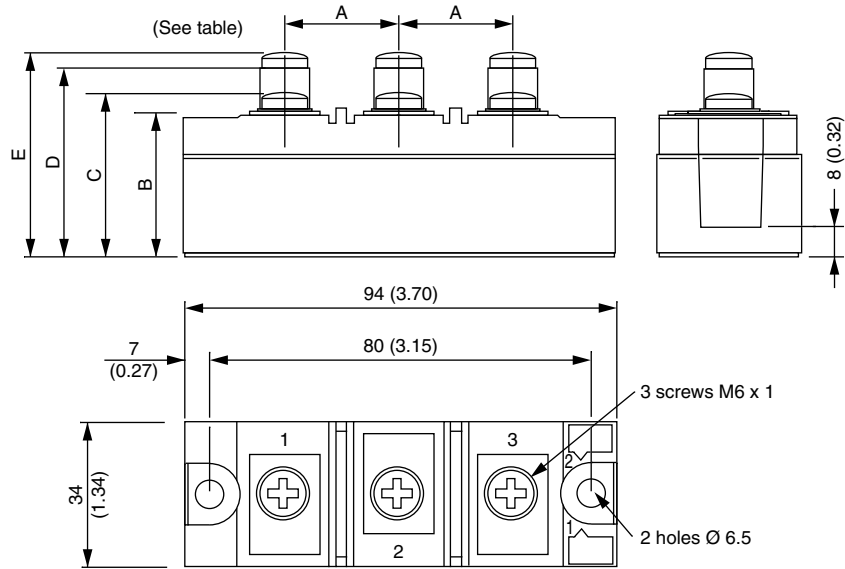

A	B	C	D	E
23 (0.91)	30 (1.18)	36 (1.42)	-	-



## Disclaimer

ALL PRODUCT, PRODUCT SPECIFICATIONS AND DATA ARE SUBJECT TO CHANGE WITHOUT NOTICE TO IMPROVE RELIABILITY, FUNCTION OR DESIGN OR OTHERWISE.

Vishay Intertechnology, Inc., its affiliates, agents, and employees, and all persons acting on its or their behalf (collectively, "Vishay"), disclaim any and all liability for any errors, inaccuracies or incompleteness contained in any datasheet or in any other disclosure relating to any product.

Vishay makes no warranty, representation or guarantee regarding the suitability of the products for any particular purpose or the continuing production of any product. To the maximum extent permitted by applicable law, Vishay disclaims (i) any and all liability arising out of the application or use of any product, (ii) any and all liability, including without limitation special, consequential or incidental damages, and (iii) any and all implied warranties, including warranties of fitness for particular purpose, non-infringement and merchantability.

Statements regarding the suitability of products for certain types of applications are based on Vishay's knowledge of typical requirements that are often placed on Vishay products in generic applications. Such statements are not binding statements about the suitability of products for a particular application. It is the customer's responsibility to validate that a particular product with the properties described in the product specification is suitable for use in a particular application. Parameters provided in datasheets and/or specifications may vary in different applications and performance may vary over time. All operating parameters, including typical parameters, must be validated for each customer application by the customer's technical experts. Product specifications do not expand or otherwise modify Vishay's terms and conditions of purchase, including but not limited to the warranty expressed therein.

Except as expressly indicated in writing, Vishay products are not designed for use in medical, life-saving, or life-sustaining applications or for any other application in which the failure of the Vishay product could result in personal injury or death. Customers using or selling Vishay products not expressly indicated for use in such applications do so at their own risk. Please contact authorized Vishay personnel to obtain written terms and conditions regarding products designed for such applications.

No license, express or implied, by estoppel or otherwise, to any intellectual property rights is granted by this document or by any conduct of Vishay. Product names and markings noted herein may be trademarks of their respective owners.

## Material Category Policy

**Vishay Intertechnology, Inc. hereby certifies that all its products that are identified as RoHS-Compliant fulfill the definitions and restrictions defined under Directive 2011/65/EU of The European Parliament and of the Council of June 8, 2011 on the restriction of the use of certain hazardous substances in electrical and electronic equipment (EEE) - recast, unless otherwise specified as non-compliant.**

**Please note that some Vishay documentation may still make reference to RoHS Directive 2002/95/EC. We confirm that all the products identified as being compliant to Directive 2002/95/EC conform to Directive 2011/65/EU.**

**Vishay Intertechnology, Inc. hereby certifies that all its products that are identified as Halogen-Free follow Halogen-Free requirements as per JEDEC JS709A standards. Please note that some Vishay documentation may still make reference to the IEC 61249-2-21 definition. We confirm that all the products identified as being compliant to IEC 61249-2-21 conform to JEDEC JS709A standards.**



Компания «Океан Электроники» предлагает заключение долгосрочных отношений при поставках импортных электронных компонентов на взаимовыгодных условиях!

Наши преимущества:

- Поставка оригинальных импортных электронных компонентов напрямую с производств Америки, Европы и Азии, а так же с крупнейших складов мира;
- Широкая линейка поставок активных и пассивных импортных электронных компонентов (более 30 млн. наименований);
- Поставка сложных, дефицитных, либо снятых с производства позиций;
- Оперативные сроки поставки под заказ (от 5 рабочих дней);
- Экспресс доставка в любую точку России;
- Помощь Конструкторского Отдела и консультации квалифицированных инженеров;
- Техническая поддержка проекта, помощь в подборе аналогов, поставка прототипов;
- Поставка электронных компонентов под контролем ВП;
- Система менеджмента качества сертифицирована по Международному стандарту ISO 9001;
- При необходимости вся продукция военного и аэрокосмического назначения проходит испытания и сертификацию в лаборатории (по согласованию с заказчиком);
- Поставка специализированных компонентов военного и аэрокосмического уровня качества (Xilinx, Altera, Analog Devices, Intersil, Interpoint, Microsemi, Actel, Aeroflex, Peregrine, VPT, Syfer, Eurofarad, Texas Instruments, MS Kennedy, Miteq, Cobham, E2V, MA-COM, Hittite, Mini-Circuits, General Dynamics и др.);

Компания «Океан Электроники» является официальным дистрибьютором и эксклюзивным представителем в России одного из крупнейших производителей разъемов военного и аэрокосмического назначения «JONHON», а так же официальным дистрибьютором и эксклюзивным представителем в России производителя высокотехнологичных и надежных решений для передачи СВЧ сигналов «FORSTAR».



## JONHON

«JONHON» (основан в 1970 г.)

Разъемы специального, военного и аэрокосмического назначения:

(Применяются в военной, авиационной, аэрокосмической, морской, железнодорожной, горно- и нефтедобывающей отраслях промышленности)

«FORSTAR» (основан в 1998 г.)

ВЧ соединители, коаксиальные кабели, кабельные сборки и микроволновые компоненты:

(Применяются в телекоммуникациях гражданского и специального назначения, в средствах связи, РЛС, а так же военной, авиационной и аэрокосмической отраслях промышленности).



Телефон: 8 (812) 309-75-97 (многоканальный)

Факс: 8 (812) 320-03-32

Электронная почта: [ocean@oceanchips.ru](mailto:ocean@oceanchips.ru)

Web: <http://oceanchips.ru/>

Адрес: 198099, г. Санкт-Петербург, ул. Калинина, д. 2, корп. 4, лит. А