

# ATC 800 C Series NPO Ceramic High RF Power Multilayer Capacitors

- Case C Size (.250" x .250")
- Capacitance Range: 2.2 pF to 3000 pF
- High Q
- Ultra-Stable Performance
- Low ESR/ESL
- High RF Current/Voltage
- High RF Power
- High Reliability
- 3600 WVDC
- RoHS Compliant, Pb free

ATC's 800 C Series offers superb performance in demanding high RF power applications requiring consistent and reliable operation. The combination of highly conductive metal electrode systems, optimized case geometries, and proprietary dielectrics, yields the lowest ESR. ATC's new NPO low loss rugged dielectrics are designed to provide superior heat transfer in high RF power applications. Ultra-low ESR and superior thermal performance ensure that the 800 C Series products are your best choice for high RF power applications from VHF through microwave frequencies.

Typical functional applications: Bypass, Coupling, Tuning, Impedance Matching and DC Blocking.

Typical circuit applications: HF/RF Power Amplifiers, Transmitters, Antenna Tuning, Plasma Chambers and Medical (MRI coils).

## ENVIRONMENTAL TESTS

ATC 800 C Series Capacitors are designed and manufactured to meet and exceed the requirements of EIA-198, MIL-PRF-55681 and MIL-PRF-123.

### THERMAL SHOCK:

MIL-STD-202, Method 107, Condition A.

### MOISTURE RESISTANCE:

MIL-STD-202, Method 106.

### LOW VOLTAGE HUMIDITY:

MIL-STD-202, Method 103, Condition A, with 1.5 Volts DC applied while subjected to an environment of 85°C with 85% relative humidity for 240 hours min.

### LIFE TEST:

MIL-STD-202, Method 108, for 2000 hours, at 125°C. Voltage applied.

200% of WVDC for capacitors rated at 500 volts DC or less.  
120% of WVDC for capacitors rated at 1250 volts DC or less.  
100% of WVDC for capacitors rated above 1250 volts DC.

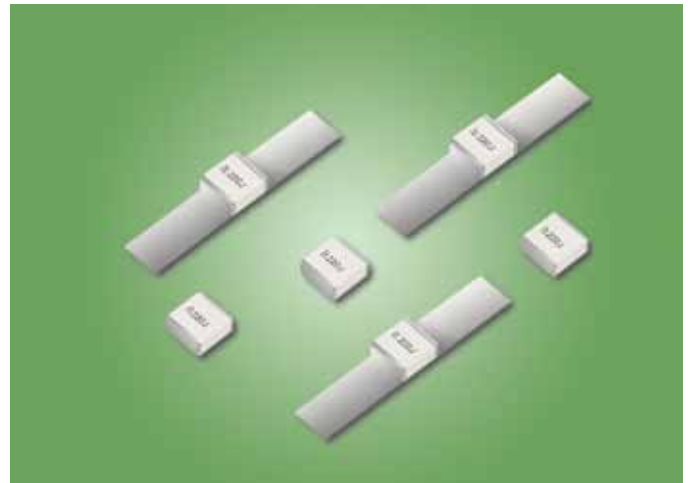

## ELECTRICAL AND MECHANICAL SPECIFICATIONS

### QUALITY FACTOR (Q):

Greater than 5,000 (2.2 pF to 1000 pF) @ 1 MHz.  
Greater than 5,000 (1100 pF to 3000 pF) @ 1 KHz.

### TEMPERATURE COEFFICIENT OF CAPACITANCE (TCC):

0 ±30 PPM/°C (-55°C to +125°C)

### INSULATION RESISTANCE (IR):

2.2 pF to 3000 pF:  
10<sup>5</sup> Megohms min. @ +25°C at rated WVDC.  
10<sup>4</sup> Megohms min. @ +125°C at rated WVDC.  
Max. test voltage is 500 VDC.

**WORKING VOLTAGE (WVDC):** See Capacitance Values Table, p 2.

### DIELECTRIC WITHSTANDING VOLTAGE (DWV):

250% of WVDC for capacitors rated at 500 volts DC or less for 5 seconds.  
150% of WVDC for capacitors rated above 500 volts DC and ≤1250 volts DC for 5 seconds.  
120% of WVDC for capacitors rated above 1250 volts DC for 5 seconds.

**RETRACE:** Less than ±(0.02% or 0.02 pF), whichever is greater.

**AGING EFFECTS:** None

**PIEZOELECTRIC EFFECTS:** None  
(No capacitance variation with voltage or pressure).

**CAPACITANCE DRIFT:** ±(0.02% or 0.02 pF), whichever is greater.

### OPERATING TEMPERATURE RANGE:

From -55°C to +125°C (No derating of working voltage).

### TERMINATION STYLES:

See Mechanical Configurations, page 3.

**TERMINAL STRENGTH:** Terminations for chips withstand a pull of 10 lbs. min., 20 lbs. typical, for 5 seconds in direction perpendicular to the termination surface of the capacitor. Test per MIL-STD-202, method 211.



**AMERICAN**  
ATC North America  
sales@atceramics.com

**TECHNICAL**  
ATC Europe  
saleseur@atceramics.com

**CERAMICS**  
ATC Asia  
sales@atceramics-asia.com

**THE ENGINEERS' CHOICE®**  
ISO 9001 REGISTERED COMPANY

**THE ENGINEERS' CHOICE™**

**www.atceramics.com**

ATC # 001-1076 Rev. M; 1/14

# ATC 800 C Capacitance Values

CAP CODE	CAP (pF)	TOL.	RATED WVDC	CAP CODE	CAP (pF)	TOL.	RATED WVDC	CAP CODE	CAP (pF)	TOL.	RATED WVDC
2R2	2.2	B, C, D	3600	240	24	F, G, J, K	3600	241	240	F, G, J, K	1000
2R4	2.4			270	27			271	270		
2R7	2.7			300	30			301	300		
3R0	3.0			330	33			331	330		
3R3	3.3			360	36			361	360		
3R6	3.6			390	39			391	390		
3R9	3.9			430	43			431	430		
4R3	4.3			470	47			471	470		
4R7	4.7			510	51			511	510		
5R1	5.1			560	56			561	560		
5R6	5.6	620	62	621	620						
6R2	6.2	680	68	681	680						
6R8	6.8	750	75	751	750						
7R5	7.5	820	82	821	820						
8R2	8.2	910	91	911	910						
9R1	9.1	101	100	102	1000						
100	10	F, G, J, K	2500	111	110	F, G, J, K	2500	112	1100	F, G, J, K	600
110	11			121	120			122	1200		
120	12			131	130			152	1500		
130	13			151	150			182	1800		
150	15			161	160			222	2200		
160	16			181	180			242	2400		
180	18			201	200			272	2700		
200	20			221	220			302	3000		
220	22										

CAPACITANCE TOLERANCE							
Code	B	C	D	F	G	J	K
Tol.	±0.1 pF	±0.25 pF	±0.5 pF	±1%	±2%	±5%	±10%

## ATC PART NUMBER CODE

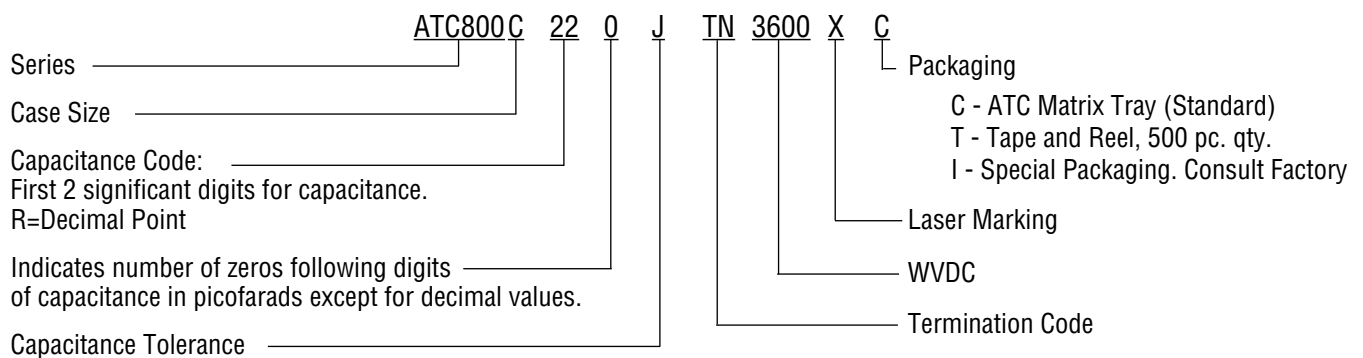

The above part number refers to a 800 C Series (case size C) 22 pF capacitor, J tolerance (±5%),3600 WVDC, with TN termination (RoHS Compliant, Tin Plated over Non-Magnetic Barrier Termination), laser marking and plastic Matrix Tray packaging.

ATC accepts orders for our parts using designations **with** or **without** the "ATC" prefix. Both methods of defining the part number are equivalent, i.e., part numbers referenced with the "ATC" prefix are interchangeable to parts referenced without the "ATC" prefix. Customers are free to use either in specifying or procuring parts from American Technical Ceramics.

For additional information and catalogs contact your ATC representative or call direct at (+1-631) 622-4700.

Consult factory for additional performance data.



**A M E R I C A N T E C H N I C A L C E R A M I C S**

ATC North America  
sales@atceramics.com

ATC Europe  
saleseur@atceramics.com

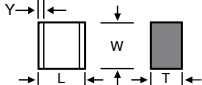

ATC Asia  
sales@atceramics-asia.com

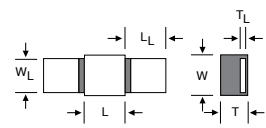
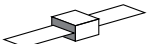
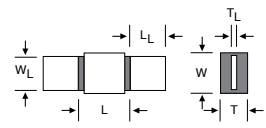
## ATC 800 C Capacitors: Mechanical Configurations

ATC SERIES & CASE SIZE <sup>Order.</sup>	ATC TERM. CODE	CASE SIZE & TYPE	OUTLINES W/T IS A TERMINATION SURFACE	BODY DIMENSIONS INCHES (mm)			LEAD AND TERMINATION DIMENSIONS AND MATERIALS		
				LENGTH (L)	WIDTH (W)	THICKNESS (T)	OVERLAP (Y)	MATERIALS	
800C	T	 C Solderable Barrier		230 +.025 -.010 (5.84 +0.64 -0.25)	250 ±.015 (6.35 ±0.38)	75 (4.45) max.	.040 (1.02) max.	<b>RoHS Compliant</b> Tin Plated over Nickel Barrier Termination	
800C	MS	 C Microstrip		245 ±.025 (6.22 ±0.64)				Silver Leads L <sub>L</sub> = .500 (12.7) min. W <sub>L</sub> = * * See below T <sub>L</sub> = .004 ±.001 (.102 ±.025)	High Purity Silver Leads L <sub>L</sub> = .500 (12.7) min. W <sub>L</sub> = .240 ±.005 (6.10 ±.127) T <sub>L</sub> = .004 ±.001 (.102 ±.025) Leads are Attached with High Temperature Solder
800C	AR	 C Axial Ribbon							

Custom lead styles and lengths are available; consult factory. All leads are high purity silver attached with high temperature solder and are **RoHS** compliant.  
 \*\*W<sub>L</sub> = .110 (2.79) for capacitance values ≤ 680 pF; W<sub>L</sub> = .130 (3.30) for capacitance values > 680 pF

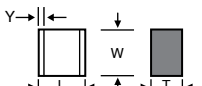
## ATC 800 C Capacitors: Non-Magnetic Mechanical Configurations

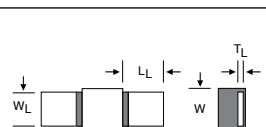
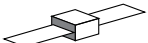
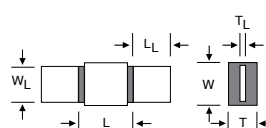
ATC SERIES & CASE SIZE <sup>Order.</sup>	ATC TERM. CODE	CASE SIZE & TYPE	OUTLINES W/T IS A TERMINATION SURFACE	BODY DIMENSIONS INCHES (mm)			LEAD AND TERMINATION DIMENSIONS AND MATERIALS	
				LENGTH (L)	WIDTH (W)	THICKNESS (T)	OVERLAP (Y)	MATERIALS
800C	TN	 C Non-Mag Solderable Barrier.		230 +.025 -.010 (5.84 +0.64 -0.25)	50 ±.015 (6.35 ±0.38)	75 (4.45) max.	.040 (1.02) max.	<b>RoHS Compliant</b> Tin Plated over Non-Magnetic Barrier Termination
800C	MN	 C Non-Mag Microstrip245		±.025 (6.22 ±0.64)				High Purity Silver Leads L <sub>L</sub> = .500 (12.7) min. W <sub>L</sub> = .240 ±.005 (6.10 ±.127) T <sub>L</sub> = .004 ±.001 (.102 ±.025) Leads are Attached with High Temperature Solder
800C	AN	 C Non-Mag Axial Ribbon		245 ±.025 (6.22 ±0.64)				

Custom lead styles and lengths are available; consult factory. All leads are high purity silver attached with high temperature solder and are **RoHS** compliant.  
 \*\*W<sub>L</sub> = .110 (2.79) for capacitance values ≤ 680 pF; W<sub>L</sub> = .130 (3.30) for capacitance values > 680 pF

A M E R I C A N T E C H N I C A L C E R A M I C S

ATC North America  
sales@atceramics.com

ATC Europe  
sales@atceramics.com

ATC Asia  
sales@atceramics-asia.com

www.atceramics.com

# Suggested Mounting Pad Dimensions

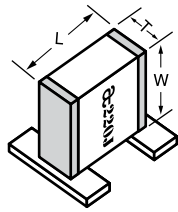
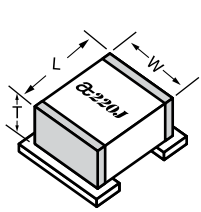

Horizontal Electrode Orientation

Vertical Electrode Orientation

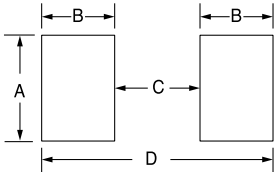

Case C Vertical Mount

Cap Value	Pad Size	A Min.	B Min.	C Min.	D Min.
All values	Normal	.200	.050	.200	.300
	High Density	.180	.030	.200	.260

Horizontal Mount

All values	Normal	.280	.050	.200	.300
	High Density	.260	.030	.200	.260

Dimensions are in inches

## ATC 800 C Performance Data

800 C ESR vs. Frequency

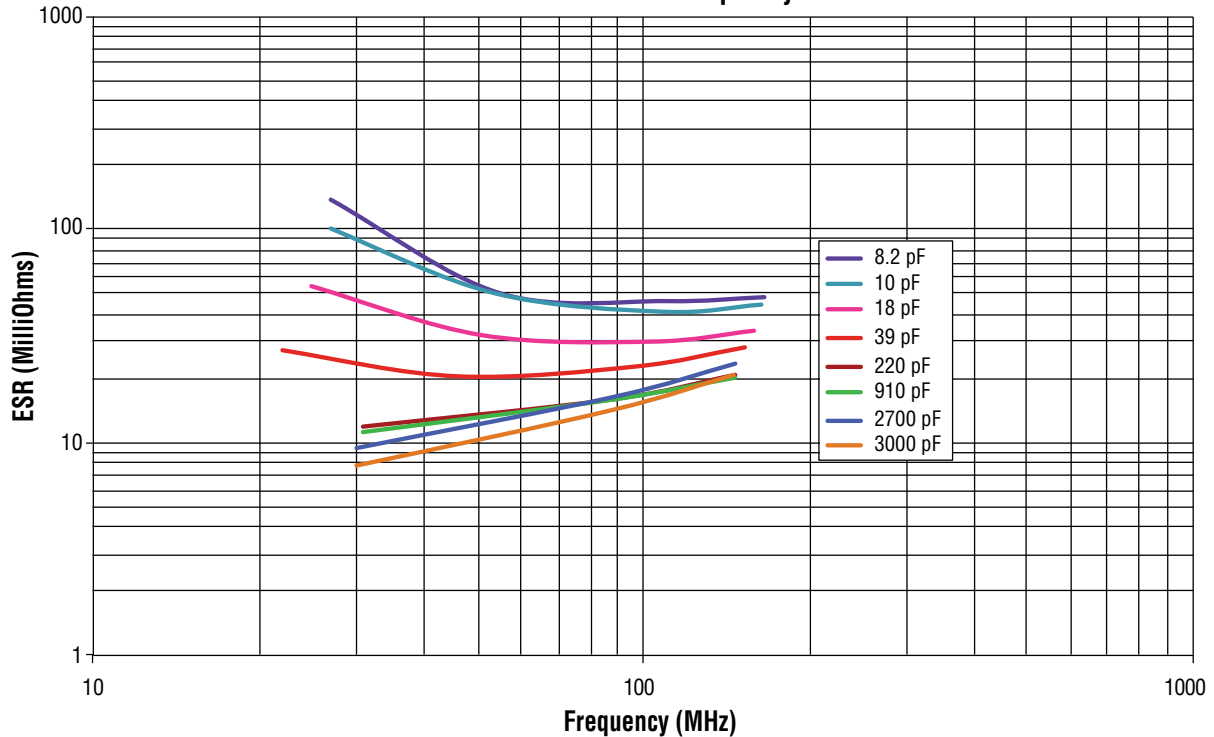

A M E R I C A N T E C H N I C A L C E R A M I C S

ATC North America  
sales@atceramics.com

ATC Europe  
saleseur@atceramics.com

ATC Asia  
sales@atceramics-asia.com

# ATC 800 C Performance Data

## 800 C Current Rating vs. Capacitance

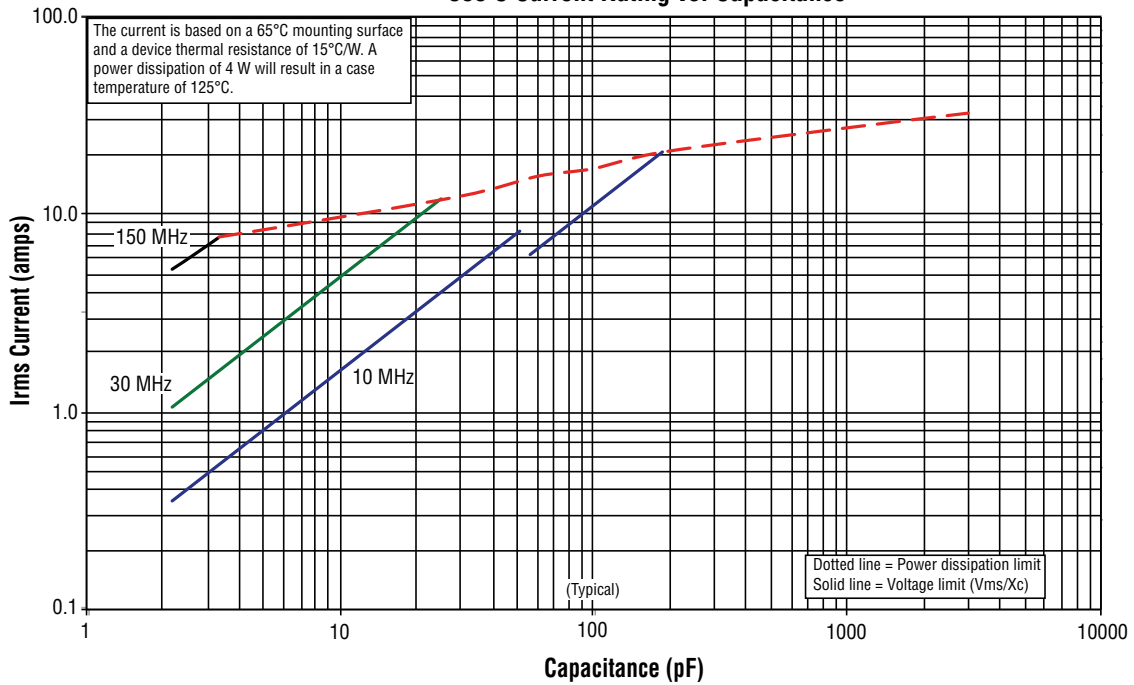

## 800C Capacitance Change vs. Temperature

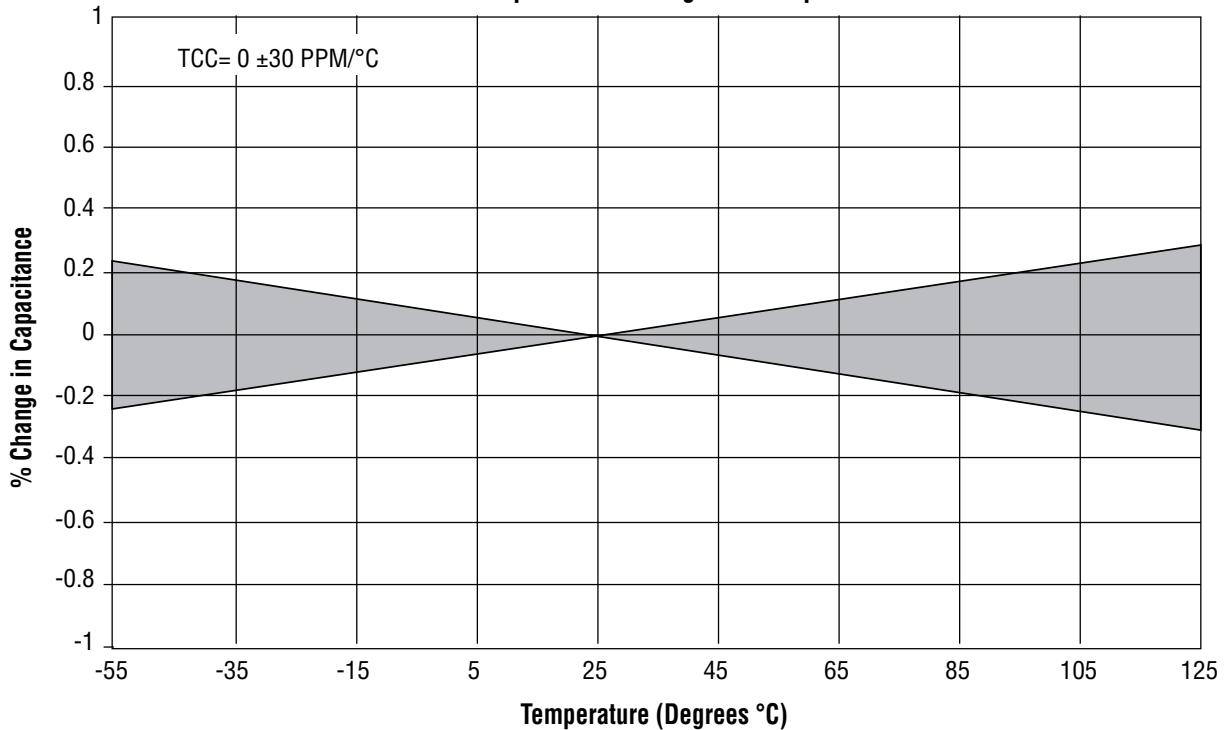

Sales of ATC products are subject to the terms and conditions contained in American Technical Ceramics Corp. Terms and Conditions of Sale (ATC document #001-992 Rev. B; 12/05). Copies of these terms and conditions will be provided upon request. They may also be viewed on ATC's website at [www.atceramics.com/productfinder/default.asp](http://www.atceramics.com/productfinder/default.asp). Click on the link for Terms and Conditions of Sale.

ATC has made every effort to have this information as accurate as possible. However, no responsibility is assumed by ATC for its use, nor for any infringements of rights of third parties which may result from its use. ATC reserves the right to revise the content or modify its product without prior notice.

© 2006 American Technical Ceramics Corp. All Rights Reserved.

ATC # 001-1076 Rev. M, 1/14

**A M E R I C A N T E C H N I C A L C E R A M I C S**

ATC North America  
sales@atceramics.com

ATC Europe  
sales@atceramics.com

ATC Asia  
sales@atceramics-asia.com

[www.atceramics.com](http://www.atceramics.com)

# Mouser Electronics

Authorized Distributor

Click to View Pricing, Inventory, Delivery & Lifecycle Information:

## [American Technical Ceramics \(ATC\):](#)

[800C100GTN3600XT](#) [800C101GT2500XT](#) [800C101GTN2500XT](#) [800C120GTN3600XT](#) [800C120JT3600XT](#)  
[800C121JTN2500XT](#) [800C130GTN3600XT](#) [800C150GTN3600XT](#) [800C151JTN2500XT](#) [800C180GTN3600XT](#)  
[800C181JT2500XT](#) [800C181JTN2500XT](#) [800C200GTN3600XT](#) [800C220GTN3600XT](#) [800C221JTN2500XT](#)  
[800C222JTN600XT](#) [800C270GT3600XT](#) [800C270JTN3600XT](#) [800C271JTN1000XT](#) [800C272KT500XT](#)  
[800C2R2BTN3600XT](#) [800C2R7BTN3600XT](#) [800C301GTN1000XT](#) [800C330JTN3600XT](#) [800C331JT1000XT](#)  
[800C331JTN1000XT](#) [800C360GTN3600XT](#) [800C390GTN3600X](#) [800C391JTN1000XT](#) [800C430GTN3600XT](#)  
[800C470GTN3600XT](#) [800C470JT3600XT](#) [800C4R3BTN3600XT](#) [800C4R7BTN3600XT](#) [800C510JT3600XT](#)  
[800C510JTN3600XT](#) [800C560GTN3600XT](#) [800C5R1BTN3600XT](#) [800C5R6BTN3600XT](#) [800C680JTN2500XT](#)  
[800C681JT1000XT](#) [800C681JTN1000XT](#) [800C6R8BTN3600XT](#) [800C820GT2500XT](#) [800C820JTN2500XT](#)  
[800C821JTN1000XT](#) [800C8R2BTN3600XT](#) [800C8R2CT3600XT](#) [800C9R1BTN3600XT](#)

Компания «Океан Электроники» предлагает заключение долгосрочных отношений при поставках импортных электронных компонентов на взаимовыгодных условиях!

Наши преимущества:

- Поставка оригинальных импортных электронных компонентов напрямую с производств Америки, Европы и Азии, а так же с крупнейших складов мира;
- Широкая линейка поставок активных и пассивных импортных электронных компонентов (более 30 млн. наименований);
- Поставка сложных, дефицитных, либо снятых с производства позиций;
- Оперативные сроки поставки под заказ (от 5 рабочих дней);
- Экспресс доставка в любую точку России;
- Помощь Конструкторского Отдела и консультации квалифицированных инженеров;
- Техническая поддержка проекта, помощь в подборе аналогов, поставка прототипов;
- Поставка электронных компонентов под контролем ВП;
- Система менеджмента качества сертифицирована по Международному стандарту ISO 9001;
- При необходимости вся продукция военного и аэрокосмического назначения проходит испытания и сертификацию в лаборатории (по согласованию с заказчиком);
- Поставка специализированных компонентов военного и аэрокосмического уровня качества (Xilinx, Altera, Analog Devices, Intersil, Interpoint, Microsemi, Actel, Aeroflex, Peregrine, VPT, Syfer, Eurofarad, Texas Instruments, MS Kennedy, Miteq, Cobham, E2V, MA-COM, Hittite, Mini-Circuits, General Dynamics и др.);

Компания «Океан Электроники» является официальным дистрибьютором и эксклюзивным представителем в России одного из крупнейших производителей разъемов военного и аэрокосмического назначения «JONHON», а так же официальным дистрибьютором и эксклюзивным представителем в России производителя высокотехнологичных и надежных решений для передачи СВЧ сигналов «FORSTAR».



## JONHON

«JONHON» (основан в 1970 г.)

Разъемы специального, военного и аэрокосмического назначения:

(Применяются в военной, авиационной, аэрокосмической, морской, железнодорожной, горно- и нефтедобывающей отраслях промышленности)

«FORSTAR» (основан в 1998 г.)

ВЧ соединители, коаксиальные кабели, кабельные сборки и микроволновые компоненты:

(Применяются в телекоммуникациях гражданского и специального назначения, в средствах связи, РЛС, а так же военной, авиационной и аэрокосмической отраслях промышленности).



Телефон: 8 (812) 309-75-97 (многоканальный)

Факс: 8 (812) 320-03-32

Электронная почта: [ocean@oceanchips.ru](mailto:ocean@oceanchips.ru)

Web: <http://oceanchips.ru/>

Адрес: 198099, г. Санкт-Петербург, ул. Калинина, д. 2, корп. 4, лит. А