

LTM4675, LTM4676A LTM4677, LTM4620A PSM μ Module Power Stick

DESCRIPTION

Demonstration circuit 2204B is a very compact demo board that showcases five different Linear Technology devices – LTM4675, LTM4676A, LTM4677, LTM4620A and LTC2974. These devices cover various product lines including DC/DC μ Module[®] regulator with digital power system management (LTM4675, LTM4676A and LTM4677), high current analog DC/DC μ Module regulator (LTM4620A) and I²C/SMBus/PMBus power system managers with EEPROM (LTC2974). Please see data sheets for more detailed information.

DC2204B contains seven different rails, including six single-phase rails and one dual-phase single-output rail from LTM4677. The μ Module regulators used on this board only require only a few external components and therefore can greatly save the footprint, reduce the design effort and improve the system reliability. The LTC2974 monitors LTM4620A's output voltage, load current and temperature through external diodes.

DC2204B powers up to default settings and produce power based on configuration resistors without the need for any serial bus communication. This allows easy evaluation of

the DC/DC μ Module regulators. There is also a connector to wall adapter which allows easy demonstration without DC/DC power supply. Multiple DC2204B boards can be cascaded together to form a high channel count power supply.

To fully explore the extensive power system management features of the part, download the GUI software LTpowerPlay™ onto your PC and use LTC's I²C/SMBus/PMBus dongle DC1613A to connect to the board. LTpowerPlay allows the user to reconfigure the part on the fly and store the configuration in EEPROM, view telemetry of voltage, current, temperature and fault status.

GUI Download

The software can be downloaded from:
<http://www.linear.com/ltpowerplay>

Design files for this circuit board are available at
<http://www.linear.com/demo/DC2204B>

LT, LT, LTC, LTM, Linear Technology, μ Module and the Linear logo are registered trademarks and LTpowerPlay is a trademark of Analog Devices, Inc. All other trademarks are the property of their respective owners.

BOARD PHOTO

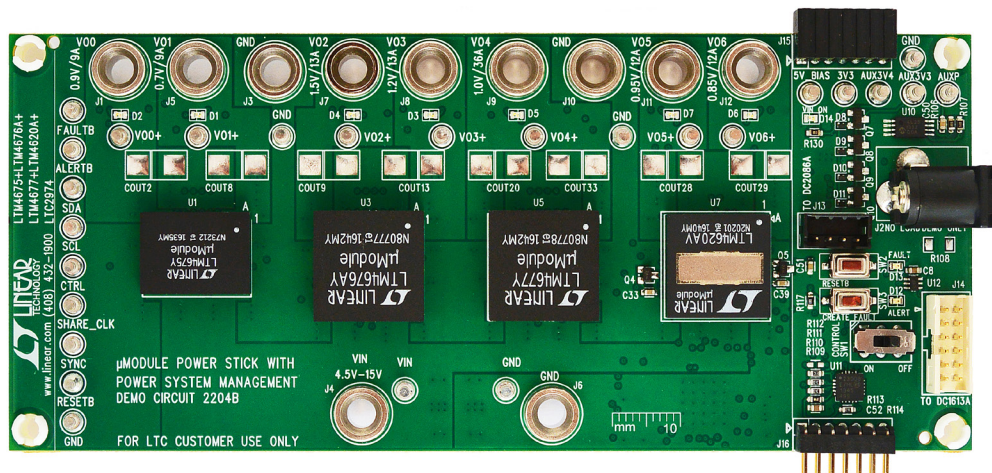

Figure 1. Board Picture of DC2204B PSM μ Module Power Stick

DEMO MANUAL DC2204B

PERFORMANCE SUMMARY Specifications are at $T_A = 25^\circ\text{C}$

PARAMETER	μ MODULE PART NUMBER	CONDITION	UNITS
Input Voltage Range			4.5V to 15V
Output Voltage, V_{O0}	LTM4675	$V_{IN} = 4.5\text{V to }15\text{V}$, $I_{O0} = 0\text{A to }9\text{A}$	0.5V to 3.5V*, Default: 0.9V
Maximum Output Current, I_{O0}	LTM4675	$V_{IN} = 4.5\text{V to }15\text{V}$, $V_{O0} = 0.5\text{V to }5.5\text{V}$	9A**
Output Voltage, V_{O1}	LTM4675	$V_{IN} = 4.5\text{V to }15\text{V}$, $I_{O1} = 0\text{A to }9\text{A}$	0.5V to 3.5V*, Default: 0.7V
Maximum Output Current, I_{O1}	LTM4675	$V_{IN} = 4.5\text{V to }15\text{V}$, $V_{O1} = 0.5\text{V to }5.5\text{V}$	9A**
Output Voltage, V_{O2}	LTM4676A	$V_{IN} = 4.5\text{V to }15\text{V}$, $I_{O2} = 0\text{A to }13\text{A}$	0.5V to 3.5V*, Default: 1.5V
Maximum Output Current, I_{O2}	LTM4676A	$V_{IN} = 4.5\text{V to }15\text{V}$, $V_{O2} = 0.5\text{V to }5.5\text{V}$	13A**
Output Voltage, V_{O3}	LTM4676A	$V_{IN} = 4.5\text{V to }15\text{V}$, $I_{O3} = 0\text{A to }13\text{A}$	0.5V to 3.5V*, Default: 1.2V
Maximum Output Current, I_{O3}	LTM4676A	$V_{IN} = 4.5\text{V to }15\text{V}$, $V_{O3} = 0.5\text{V to }5.5\text{V}$	13A**
Output Voltage, V_{O4}	LTM4677	$V_{IN} = 4.5\text{V to }15\text{V}$, $I_{O4} = 0\text{A to }36\text{A}$	0.5V to 1.8V, Default: 1V
Maximum Output Current, I_{O4}	LTM4677	$V_{IN} = 4.5\text{V to }15\text{V}$, $V_{O4} = 0.5\text{V to }1.8\text{V}$	36A**
Output Voltage, V_{O5}	LTM4620A	$V_{IN} = 4.5\text{V to }15\text{V}$, $I_{O5} = 0\text{A to }13\text{A}$	0.6V to 3.5V*, Default: 0.95V
Maximum Output Current, I_{O5}	LTM4620A	$V_{IN} = 4.5\text{V to }15\text{V}$, $V_{O5} = 0.6\text{V to }5.3\text{V}$	13A**
Output Voltage, V_{O6}	LTM4620A	$V_{IN} = 4.5\text{V to }15\text{V}$, $I_{O6} = 0\text{A to }13\text{A}$	0.6V to 3.5V*, Default: 0.85V
Maximum Output Current, I_{O6}	LTM4620A	$V_{IN} = 4.5\text{V to }15\text{V}$, $V_{O6} = 0.6\text{V to }5.3\text{V}$	13A**

*Note: The LTM4675, LTM4676A and LTM4620A can provide outputs up to 5.5V (5.3V for LTM4620A); however 4V-rated output ceramic capacitors are used on board. When running at higher output voltage, 6.3V-rated output capacitors should be used.

**Note: When running at full load, forced air flow is needed.

QUICK START PROCEDURE

Demonstration circuit 2204B is easy to set up to evaluate the performance of four μ Modules. The following procedure describes how to set up a DC2204B demo system. Please refer to Figure 2 for the test setup and Figure 3 for the DC2204B top side details.

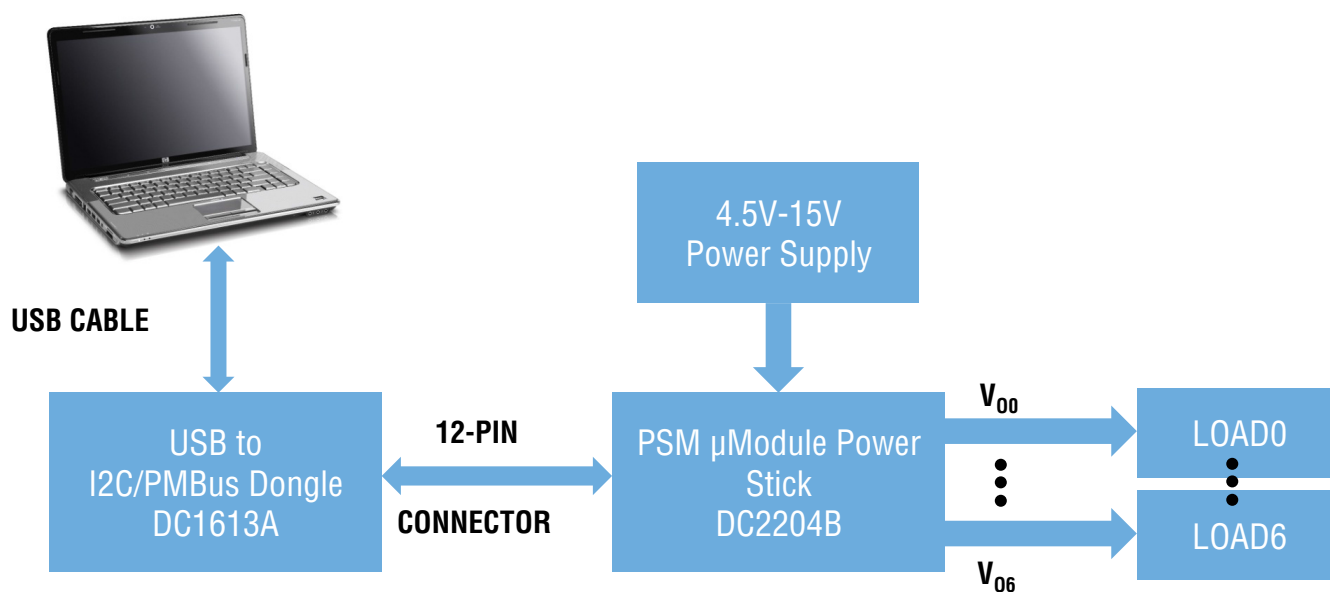

Figure 2. DC2204B Test Setup

QUICK START PROCEDURE

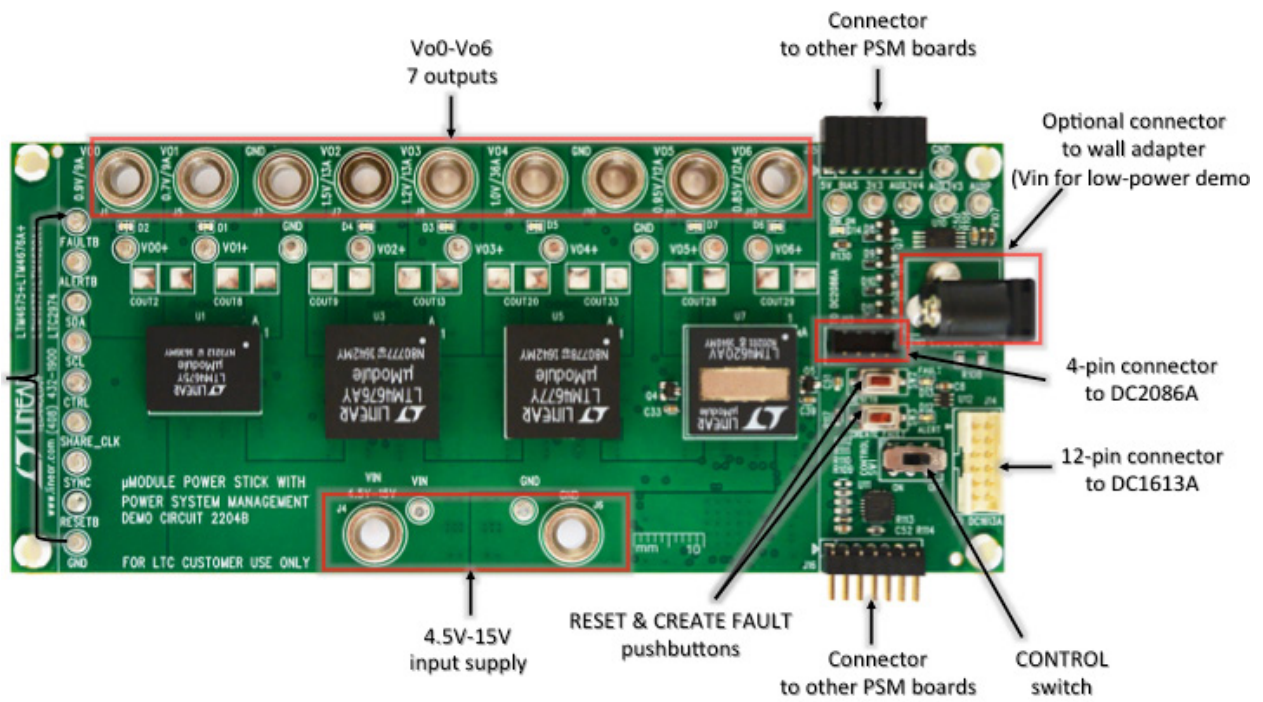

Figure 3. DC2204B Top Side Details

DEMO MANUAL DC2204B

QUICK START PROCEDURE

1. Download and install the LTpowerPlay GUI;
2. Connect the DC1613A dongle to the DC2204B using the 12-pin ribbon cable;
3. With power off, connect the input power supply (4.5V to 15V) to V_{IN} and GND;
4. Launch the LTpowerPlay GUI (the LTpowerPlay Main Interface is shown in Figure 4):

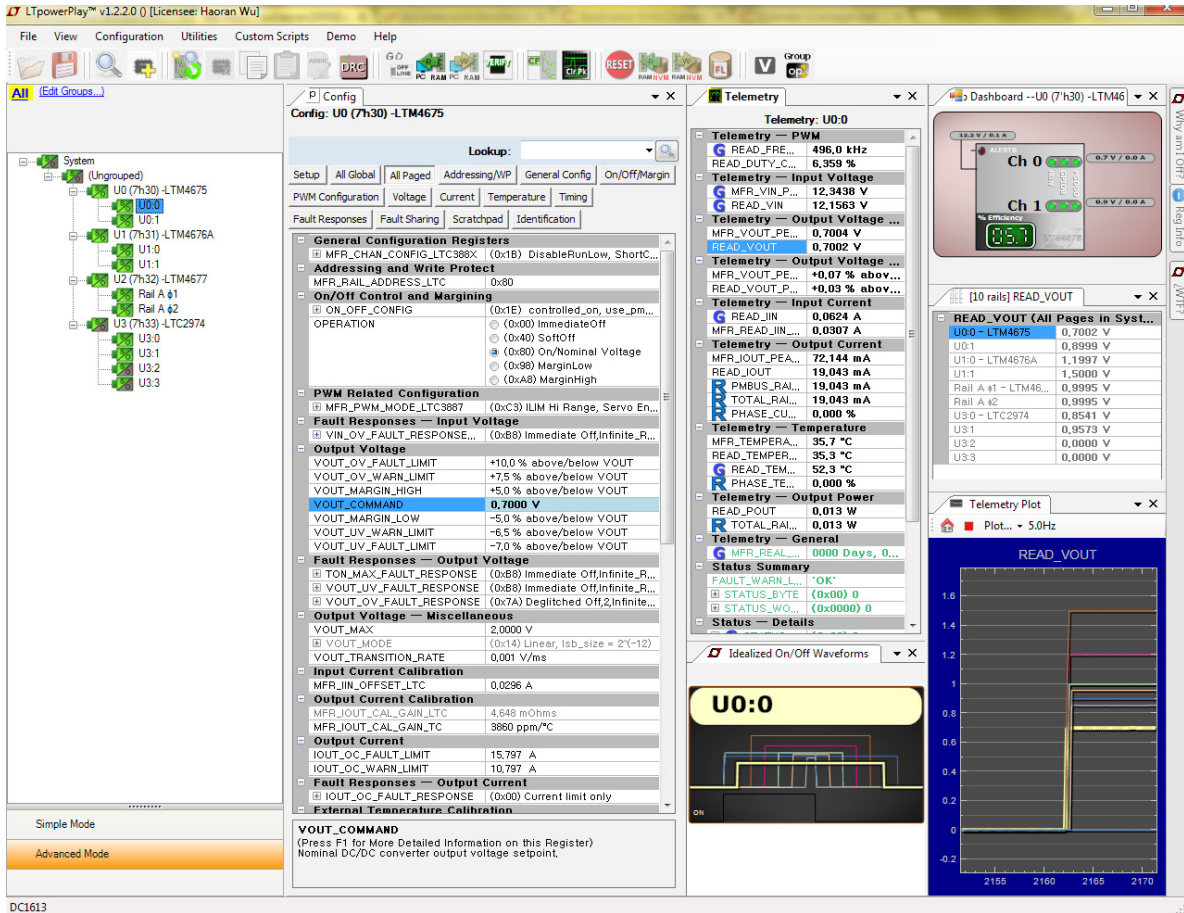
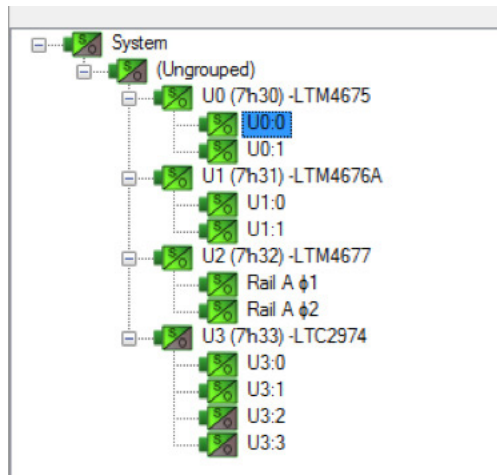

Figure 4. LTpowerPlay Main Interface

QUICK START PROCEDURE

a. The GUI will automatically identify the DC2204B and build a system tree for each PSM μ Modules and manager. The system tree on the left hand side will look as below:



b. A green message box will be displayed momentarily in the lower left hand corner confirming that the DC2204B is communicating.

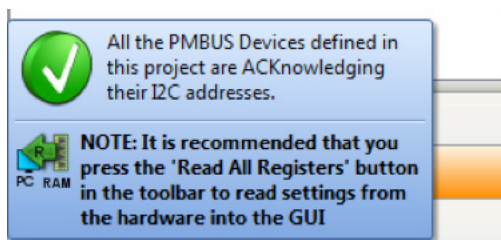

c. Save the demo board configuration to a (*.proj) file by clicking the Save icon. This creates a backup file.

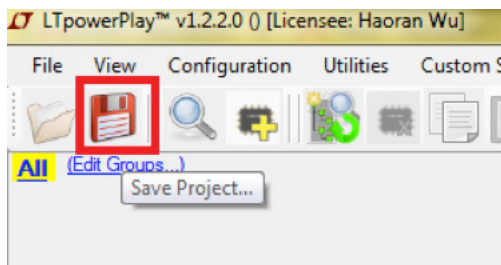

5. The CONTROL switch is configured to control all seven rails. Slide the switch to ON to enable, OFF to disable all rails.

COMMON DEMO BOARD OPERATIONS

DC2204B On-Board LEDs

Each individual rail on DC2204B has its own green power-good LED indicator (D1 through D7). There is another green LED (D12) which is on after V_{IN} supply is applied. Two red LEDs (D12 and D13) will illuminate when an alert or a fault has occurred.

Margin All Rails

The digital power products on the DC2204B not only monitor each of their respective outputs but can margin the outputs either high or low. Margining is the operation that moves a rail either up or down for testing purposes. It allows a system to be fully characterized over supply limits without the use of external hardware or resources. The GUI provides an easy way to margin all rails high or all low by clicking one of four buttons. To invoke the margining dialog, click the GroupOp icon in the  toolbar.

Then the user can choose Margin High, Margin Low or some other operations to all the devices from the window in below.

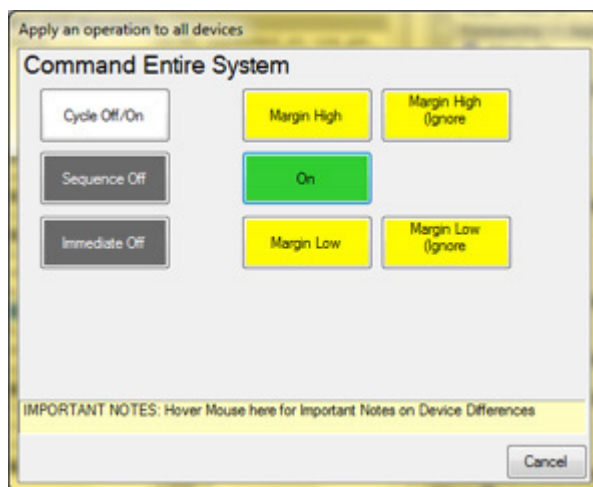

COMMON DEMO BOARD OPERATIONS

The telemetry window in the lower right hand corner shows the effect of the margin high or margin low operation. The following screen shot shows all rails going from nominal set points to margin high, margin low and back to nominal voltages.

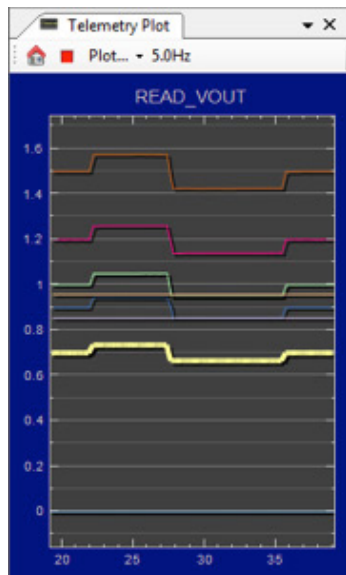

Creating and Clearing a Fault

There is a pushbutton on the DC2204B board which is used to force a fault and demonstrate the demo board's ability to detect it and respond according to the configuration.

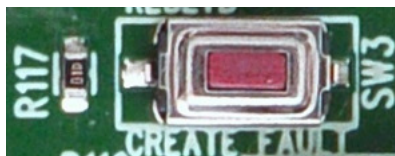

When pressing this button (SW3), it creates a VOUT_UV fault on Vo6, by pulling COMP pin low externally. The user should see Vo6 output power off, the green LED (D6) off and the red LED (D12) on. After a retry period, the rail will be back on.

To clear a fault, the user may click the CF icon in the GUI or simply push the RESET pushbutton on the demo board. In both cases, the red (+) on the CF icon and alert LED on the board will be cleared. The user will notice that all rails are automatically re-enabled after a programmable retry period.

Reset the DC2204B

A reset pushbutton is provided on the board. To reset all devices on the DC2204B board and reload the EEPROM contents into operating memory (RAM), press RESETB (SW2) on the DC2204B.

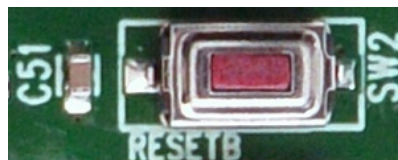

DEMO MANUAL DC2204B

PARTS LIST

ITEM	QTY	REFERENCE	PART DESCRIPTION	MANUFACTURER/PART NUMBER
Required Circuit Components				
1	2	CIN1, CIN2	POS-CAP, 100 μ F, 20V, D3L	PANASONIC, 20TQC100MYF
2	8	CIN3 TO CIN10	CAP, X5R, 10 μ F, 35V, 10%, 1210	NIC, NMC1210X5R106K35TRPLPF
3	2	C55, C56	CAP, X7R, 10 μ F, 25V, 10%, 1206	NIC, NMC1206X7R106K25TRPLPF
4	24	COUT1, COUT3, COUT4, COUT5, COUT6, COUT7, COUT10, COUT11, COUT12, COUT14, COUT15, COUT16, COUT17, COUT18, COUT21, COUT22, COUT23, COUT25, COUT26, COUT27, COUT30, COUT31, COUT32, COUT34	CAP, X5R, 220 μ F, 4V, 20%, 1206	MURATA, GRM31CR60G227ME11L
5	1	C4	CAP, X7R, 4.7nF, 25V, 10%, 0603	MURATA, GRM188R71E472KA01D
6	6	C8, C15, C20, C48, C52, C53	CAP, X7R, 1 μ F, 16V, 10%, 0603	AVX, 0603YC105KAT2A
7	1	C54	CAP, X7R, 1 μ F, 25V, 10%, 1206	AVX, 12063C105KAT2A
8	2	C9, C12	CAP, X7R, 2200pF, 25V, 10%, 0603	AVX, 06033C222KAT2A
9	1	C21	CAP, X5R, 4.7 μ F, 10V, 10%, 0805	TDK C2012X5R1A475K
10	2	R24, R103	RES, CHIP, 1.65k, 1%, 0603	VISHAY, CRCW06031K65FKEA
11	1	R22	RES, CHIP, 787, 1%, 0603	VISHAY, CRCW0603787RFKEA
12	1	U1	IC, LTM4675EY#PBF	LINEAR TECHNOLOGY, LTM4675EY#PBF
13	3	U2, U4, U6	IC, LT6700CS6-2#PBF, TSOT23	LINEAR TECHNOLOGY, LT6700CS6-2#PBF
14	1	U3	IC, LTM4676AEY#PBF	LINEAR TECHNOLOGY, LTM4676AEY#PBF
15	1	U5	IC, LTM4677EY#PBF	LINEAR TECHNOLOGY, LTM4677EY#PBF
16	1	U7	IC, LTM4620AEV#PBF	LINEAR TECHNOLOGY, LTM4620AEV#PBF
17	1	U8	IC, LTC2974CUP#PBF QFN 9mm x 9mm	LINEAR TECHNOLOGY, LTC2974CUP#PBF
18	1	U9	IC, LTC4313CMS8-2#PBF, MSOP	LINEAR TECHNOLOGY, LTC4313CMS8-2#PBF
19	1	U10	IC, 24LC025-I/ST TSSOP 8-PIN	MICROCHIP, 24LC025-I/ST
20	1	U11	IC, MCP23008-E/ML QFN 4 x 4 x 0.9 mm	MICROCHIP, MCP23008-E/ML
21	1	U12	IC, SN74LVC2G34DCKR DCK	TEXAS INSTR, SN74LVC2G34DCKR
22	1	U13	IC, LT3029MPMSE#PBF, MSOP	LINEAR TECHNOLOGY, LT3029MPMSE#PBF
Additional Demo Board Circuit Components				
23	0	COUT2, COUT8, COUT9, COUT13, COUT20, COUT28, COUT29, COUT33, C1, C2, C3, C5, C6, C7, C10, C11, C13, C14, C16, C17, C18, C19, C26, C31, C32, C34, C35, C59, C60 (OPT)	CAP, OPTIONAL	
24	16	C22, C23, C27, C29, C36, C38, C42, C44, C50, C24, C25, C37, C40, C45, C46, C47	CAP, X5R, 100nF(0.1 μ F), 16V, 10%, 0603	NIC, NMC0603X5R104K16TRPF
25	4	C28, C30, C41, C43	CAP, X7R, 3.3nF, 25V, 10%, 0603	MURATA, GRM188R71E332KA01D
26	6	C33, C39, C49, C51, C57, C58	CAP, X7R, 10nF (0.01 μ F), 16V, 10%, 0603	AVX, 0603YC103KAT2A
27	8	D1, D2, D3, D4, D5, D6, D7, D14	SMT CHIP LED, YELLOW-GREEN	PANASONIC, LNJ337W83RA
28	2	D12, D13	SMT CHIP LED, RED	PANASONIC, LNJ214R82RA
29	4	D8, D9, D10, D11	DIODE, ULTRA LOW SCHOTTKY RECTIFIER	NXP SEMI, PMEG2005AEL, 315
30	1	Q1	MOSFET P-CH 1.8V SOT-323	VISHAY, Si1315DL-T1-GE3

PARTS LIST

ITEM	QTY	REFERENCE	PART DESCRIPTION	MANUFACTURER/PART NUMBER
31	3	Q2, Q3, Q6	MOSFET N-CH 25V SOT-323	VISHAY, Si1308EDL-T1-GE3
32	2	Q4, Q5	XSTR GP SS PNP 40V SOT-323	ON SEMI, MMBT3906WT1G
33	4	Q7, Q8, Q9, Q10	MOSFET P-CH SOT-323	DIODES INC, DMP3130L-7
34	2	Q11, Q12	MOSFET N-CH 60V 115MA SOT-23	DIODES INC, 2N7002A-7

Additional Demo Board Circuit Components

35	14	R2, R4, R16, R18, R19, R25, R32, R38, R45, R48, R53, R55, R67, R77	RES, CHIP, 0Ω, 1%, 0603	NIC, NRC06ZOTRF
36	8	R3, R21, R28, R41, R58, R65, R80, R131	RES, CHIP, 62Ω, 5%, 2/3W, 1206	PANASONIC, ERJ-P08J620V
37	24	R5, R7, R8, R9, R10, R11, R12, R13, R14, R17, R36, R54, R99, R100, R101, R102, R109, R110, R111, R114, R122, R123, R125, R127	RES, CHIP, 10k, 1%, 0603	NIC, NRC06F1002TRF
38	18	R26, R27, R46, R47, R63, R97, R98, R115, R116, R72, R73, R78, R79, R92, R93, R95, R96, R130	RES, CHIP, 1k, 1%, 0603	NIC, NRC06F1001TRF
39	3	R29, R106, R107	RES, CHIP, 4.99k, 1%, 0603	NIC, NRC06F4992TRF
40	0	R20, R23, R34, R40, R43, R1, R6, R57, R59, R60, R61, R62, R49, R50, R51, R52, R75, R89, R94, R108, R112, R15, R30, R31, R33, R37, R124, R126, R128, R129	RES, OPTIONAL	
41	2	R35, R44	RES, CHIP, 4.22k, 1%, 0603	NRC, NRC06F4221TRF
42	1	R39	RES, CHIP, 787Ω, 1%, 0603	NIC, NRC06F7870TRF
43	1	R42	RES, CHIP, 3.24k, 1%, 0603	NIC, NRC06F3241TRF
44	1	R56	RES, CHIP, 1.65k, 1%, 0603	NRC, NRC06F1651TRF
45	1	R64	RES, CHIP, 200Ω, 1%, 0603	NIC, NRC06F2000TRF
46	3	R66, R76, R105	RES, CHIP, 10Ω, 1%, 0603	NIC, NRC06F10R0TRF
47	2	R68, R88	RES, CHIP, 121k, 1%, 0603	NIC, NRC06F1213TRF
48	5	R69, R70, R85, R86, R87	RES, CHIP, 100Ω, 1%, 0603	NIC, NRC06F1000TRF
49	2	R71, R120	RES, CHIP, 200k, 1%, 0603	NIC, NRC06F2003TRF
50	1	R74	RES, CHIP, 102k, 1%, 0603	NIC, NRC06F1023TRF
51	1	R81	RES, CHIP, 143k, 1%, 0603	NIC, NRC06F1433TRF
52	1	R82	RES, CHIP, 162k, 1%, 0603	NIC, NRC06F1623TRF
53	1	R104	RES, CHIP, 15.8k, 1%, 0603	NIC, NRC06F1582TRF
54	1	R113	RES, CHIP, 249Ω, 1%, 0603	NIC, NRC06F2490TRF
55	1	R117	RES, CHIP, 100k, 1%, 0603	NIC, NRC06F1003TRF
56	1	R118	RES, CHIP, 619k, 1%, 0603	NIC, NRC06F6193TRF
57	1	R119	RES, CHIP, 357k, 1%, 0603	NIC, NRC06F3573TRF
58	1	R121	RES, CHIP, 210k, 1%, 0603	NIC, NRC06F2103TRF
59	1	D15	DIODE, SOD-323	CENTRAL SEMI, CMDD4448

DEMO MANUAL DC2204B

PARTS LIST

ITEM	QTY	REFERENCE	PART DESCRIPTION	MANUFACTURER/PART NUMBER
Hardware: For Demo Board Only				
60	26	E1 TO E26	TESTPOINT, TURRET, 0.062"	MILL-MAX, 2308-2-00-80-00-00-07-0
61	11	J1, J3 TO J12	JACK, BANANA	KEYSTONE, 575-4
62	1	J2	CONN PWR JACK 2.1 × 5.5MM HIGH CUR	CUI INC, PJ-002AH
63	1	J13	HEADER, 4 PINS, SHROUDED	HIROSE, DF3A-4P-2DSA
64	1	J14	HEADER 12POS 2MM STR DL PCB	FCI, 98414-G06-12ULF (14full tbs.@40)
65	1	J15	CONN RECEPT 2MM DUAL R/A 14POS(F)	SULLINS, NPPN072FJFN-RC
66	1	J16	HEADER 14POS 2MM R/A GOLD (M)	MOLEX, 87760-1416
67	1	SW1	SWITCH, SUB MINIATURE SLIDE	C&K, JS202011CQN
68	2	SW2, SW3	SWITCH, 3.5MM SMT (1lrg.rl)	C&K, PTS635SK25SMTR LFS
69	1	SW4	SWITCH, SMT TERMINALS 3PINS	C&K, SDA03H0SBR (1lrg.rl)
70	2	XJP1, XJP2	SHUNT	SAMTEC, 2SN-BK-G

SCHEMATIC DIAGRAM

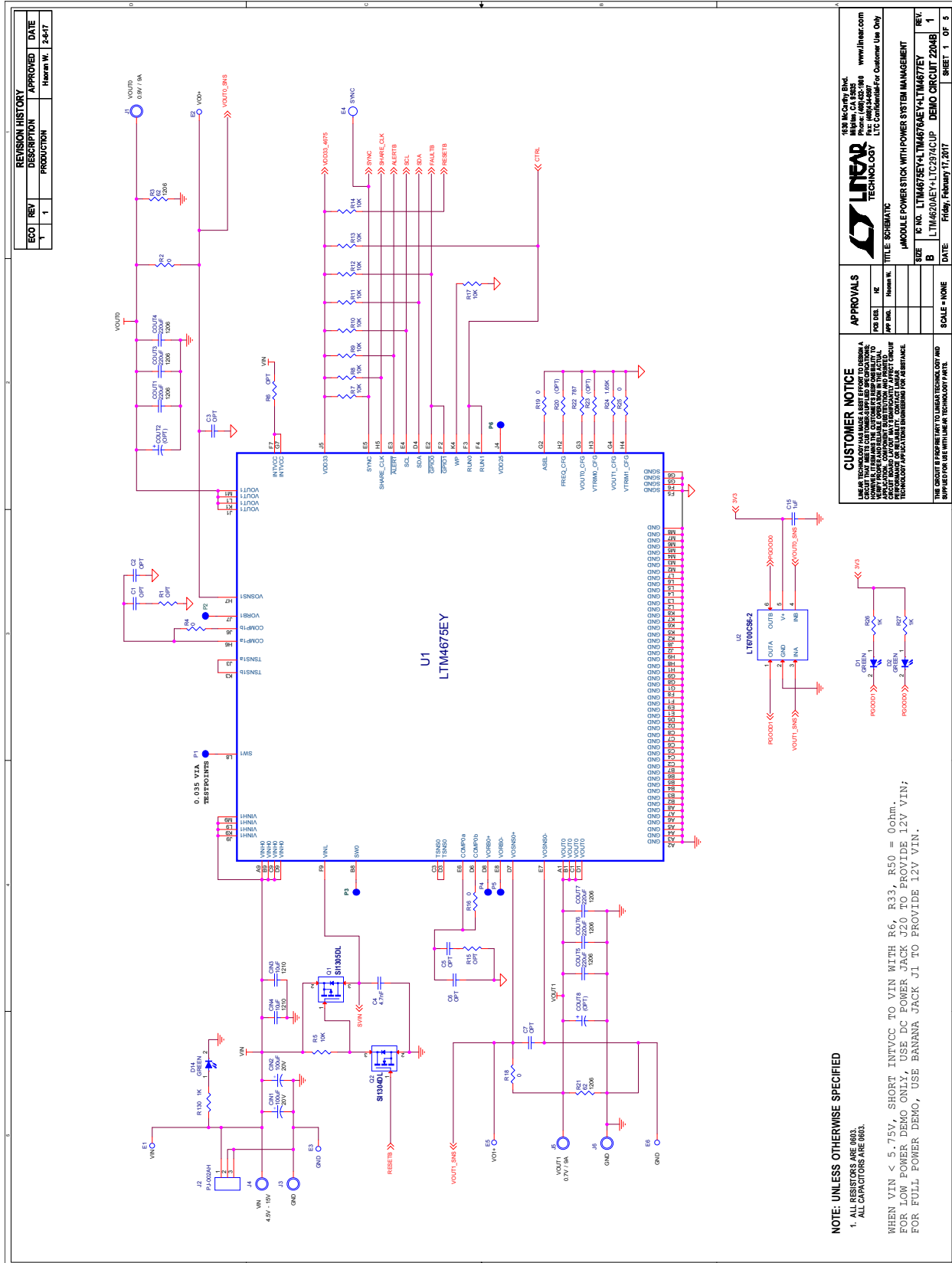

REVISION HISTORY		
ECO	REV	DESCRIPTION
1	1	PRODUCTION

APPROVED DATE		
DESIGNER	DATE	APPROVED
Heera W.	2-24-17	

CUSTOMER NOTICE
 LTM475EY1 is a demo circuit and is not intended for use in a final product. It is provided as a reference only. All components are not guaranteed to be the same as the ones shown in the schematic. The schematic is provided as a reference only. All components are not guaranteed to be the same as the ones shown in the schematic. The schematic is provided as a reference only. All components are not guaranteed to be the same as the ones shown in the schematic.

APPROVALS

DESIGNER	HE
APP. DATE	2/24/17
DESIGNER	HE
APP. DATE	2/24/17

SCALE NONE

DATE Friday, February 17, 2017

REV. 1

REV. DATE 2/24/17

REV. DESCRIPTION DEMO CIRCUIT 2204B

SHEET 1 OF 5

NOTE: UNLESS OTHERWISE SPECIFIED
 1. ALL RESISTORS ARE 0603.
 ALL CAPACITORS ARE 0603.

WHEN VIN < 5.75V, SHORT INTVCC TO VIN WITH R6, R33, R50 = 0ohm.
 FOR LOW POWER DEMO ONLY, USE DC POWER JACK J20 TO PROVIDE 12V VIN.
 FOR FULL POWER DEMO, USE BANANA JACK J1 TO PROVIDE 12V VIN.

DEMO MANUAL DC2204B

SCHEMATIC DIAGRAM

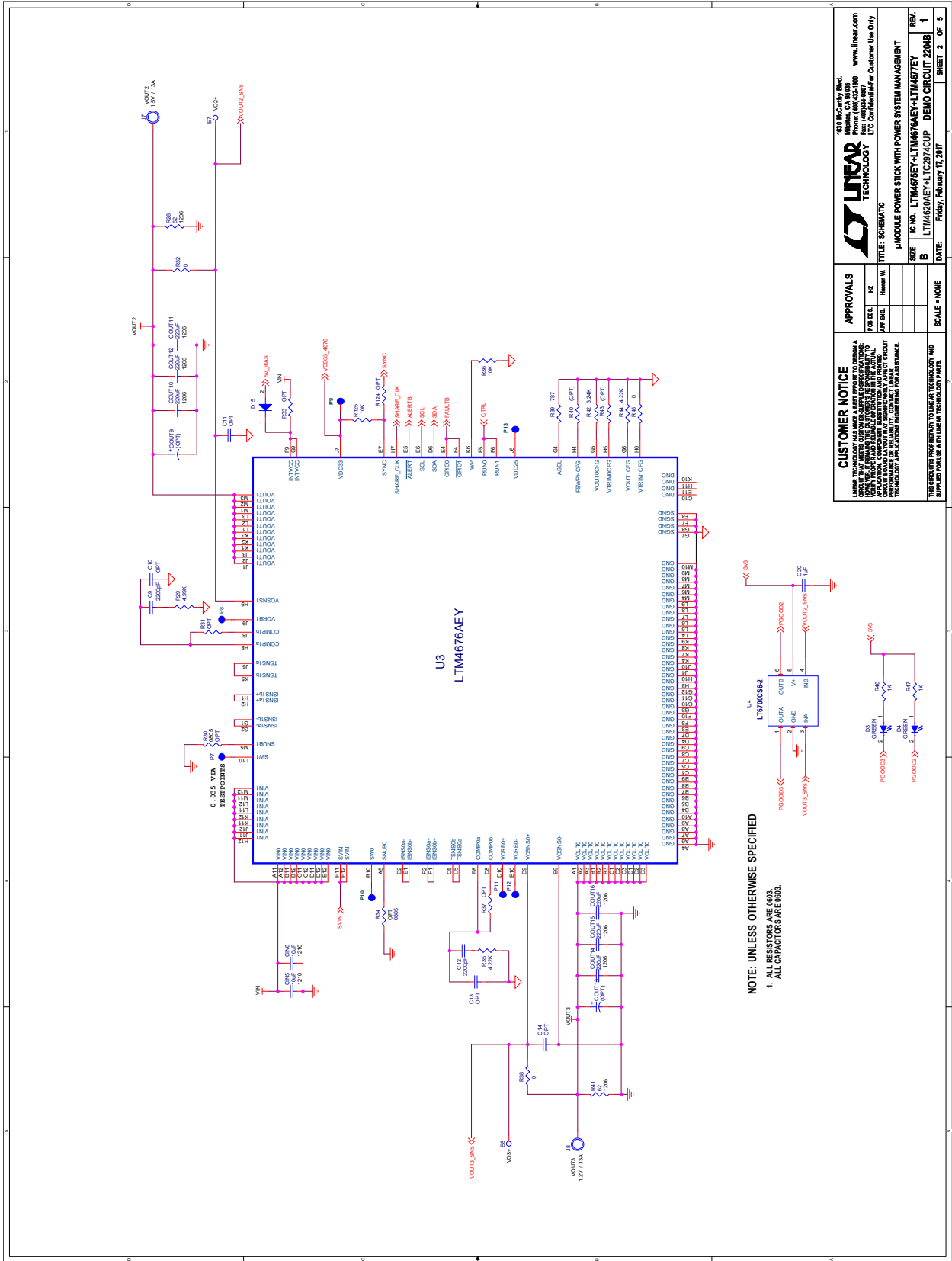

CUSTOMER NOTICE		103 McCarthy Blvd. Folsom, CA 95630 Tel: (916) 444-0000 Fax: (916) 444-0001 www.linear.com	
APPROVALS		TITLE: SCHEMATIC	
DESIGNER	NAME	DATE	SCALE
APPROVED	NAME	DATE	SCALE
LINAIR TECHNOLOGY MAKES NO WARRANTY OR REPRESENTATION, EXPRESS OR IMPLIED, REGARDING THE OPERATION OF THIS CIRCUIT BOARD OR THE RELIABILITY OF THE DATA CONTAINED HEREIN. THE USER OF THIS CIRCUIT BOARD SHALL BE RESPONSIBLE FOR OBTAINING NECESSARY APPLICATION ENGINEERING ASSISTANCE.		MICROLE POWER STICK WITH POWER SYSTEM MANAGEMENT U3 NO. LTM4676AEY+LTM4676AEY+LTM4676EY U3 NO. LTM4620AEY+LTC2974CUP DEMO CIRCUIT 2204B DATE: Friday, February 17, 2007 SHEET 2 OF 5	

SCHEMATIC DIAGRAM

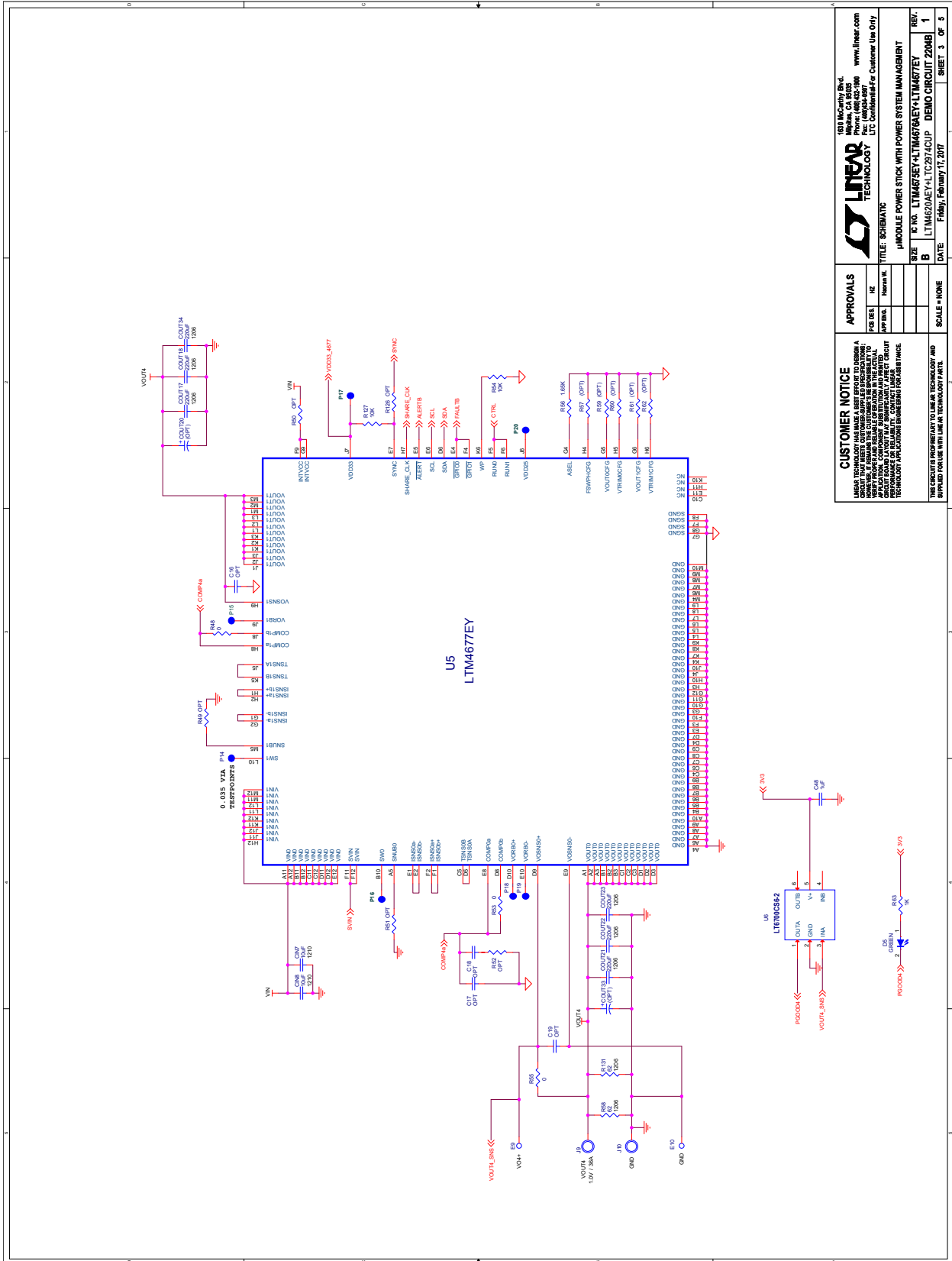

CUSTOMER NOTICE		APPROVALS	
LINEAR TECHNOLOGY MAKES NO WARRANTY OR REPRESENTATION, EXPRESS OR IMPLIED, REGARDING THE USE OF THIS PRODUCT IN THIS APPLICATION. CUSTOMER SHALL DESIGN AND VERIFY THE APPLICATION TO MEET ALL REGULATORY AND SAFETY REQUIREMENTS. LINEAR TECHNOLOGY ACCEPTS NO LIABILITY FOR DAMAGES OF ANY KIND, INCLUDING CONSEQUENTIAL DAMAGES, ARISING FROM THE USE OF THIS PRODUCT IN THIS APPLICATION.			
DESIGNED BY	DATE	DESIGNED BY	DATE
CHECKED BY	DATE	CHECKED BY	DATE
APPROVED BY	DATE	APPROVED BY	DATE
TITLE: SCHEMATIC		SCALE: NONE	
REV. NO. LTM4677EY-LT14676AET4-LTM4677EY	REV. 1	REV. NO. LTM4622DAEY-LT1C2974CUP	REV. 1
DATE: Friday, February 17, 2007		DATE: Friday, February 17, 2007	
SHEET 3 OF 5		SHEET 3 OF 5	

100 McCarthy Blvd.
Folsom, CA 95630
Tel: (916) 451-0000
Fax: (916) 451-0001
www.linear.com
LTC Confidential - For Customer Use Only

LINEAR TECHNOLOGY
MICROLE POWER STICK WITH POWER SYSTEM MANAGEMENT

DEMO MANUAL DC2204B

SCHEMATIC DIAGRAM

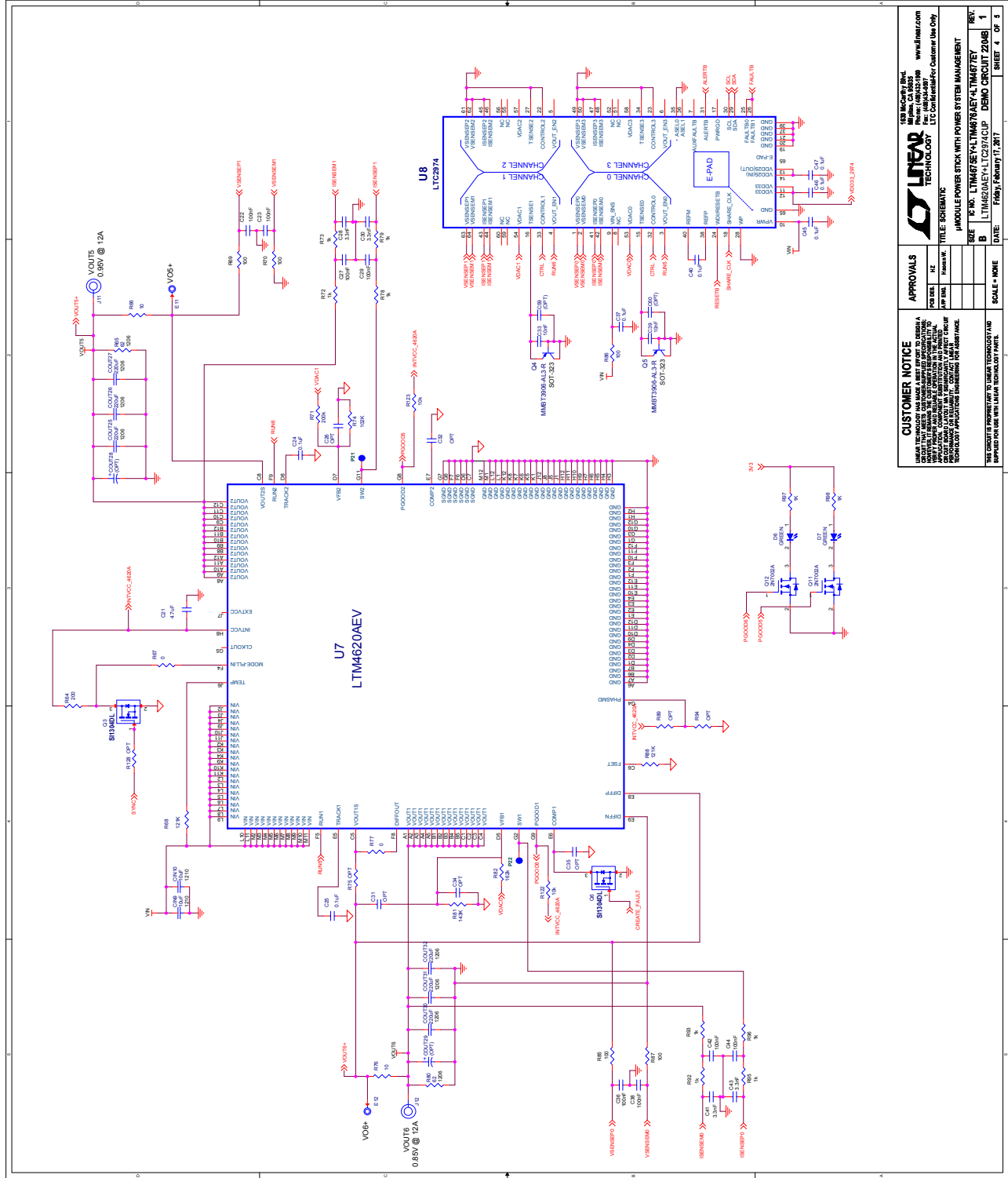

CUSTOMER NOTICE LINEAR TECHNOLOGY HAS MADE A BEST EFFORT TO DESIGN A SCHEMATIC THAT REPRESENTS THE INTENT OF THE ORIGINAL DESIGN. THE SCHEMATIC IS PROVIDED AS A GUIDE ONLY. THE USER IS RESPONSIBLE FOR VERIFYING THE SCHEMATIC AGAINST THE ORIGINAL DESIGN AND FOR MAKING ANY NECESSARY ADJUSTMENTS TO THE SCHEMATIC TO MATCH THE ORIGINAL DESIGN.	
APPROVALS FOR USE: _____ NAME: _____ TITLE: _____	LINEAR TECHNOLOGY 1380 McCarty Blvd. Fremont, CA 94538-1199 Tel: 925-462-0000 Fax: 925-462-0001 www.linear.com
REVISIONS REVISION NO. _____ DATE: _____ BY: _____ CHECKED BY: _____	SCALE - NONE SHEET 4 OF 5

SCHEMATIC DIAGRAM

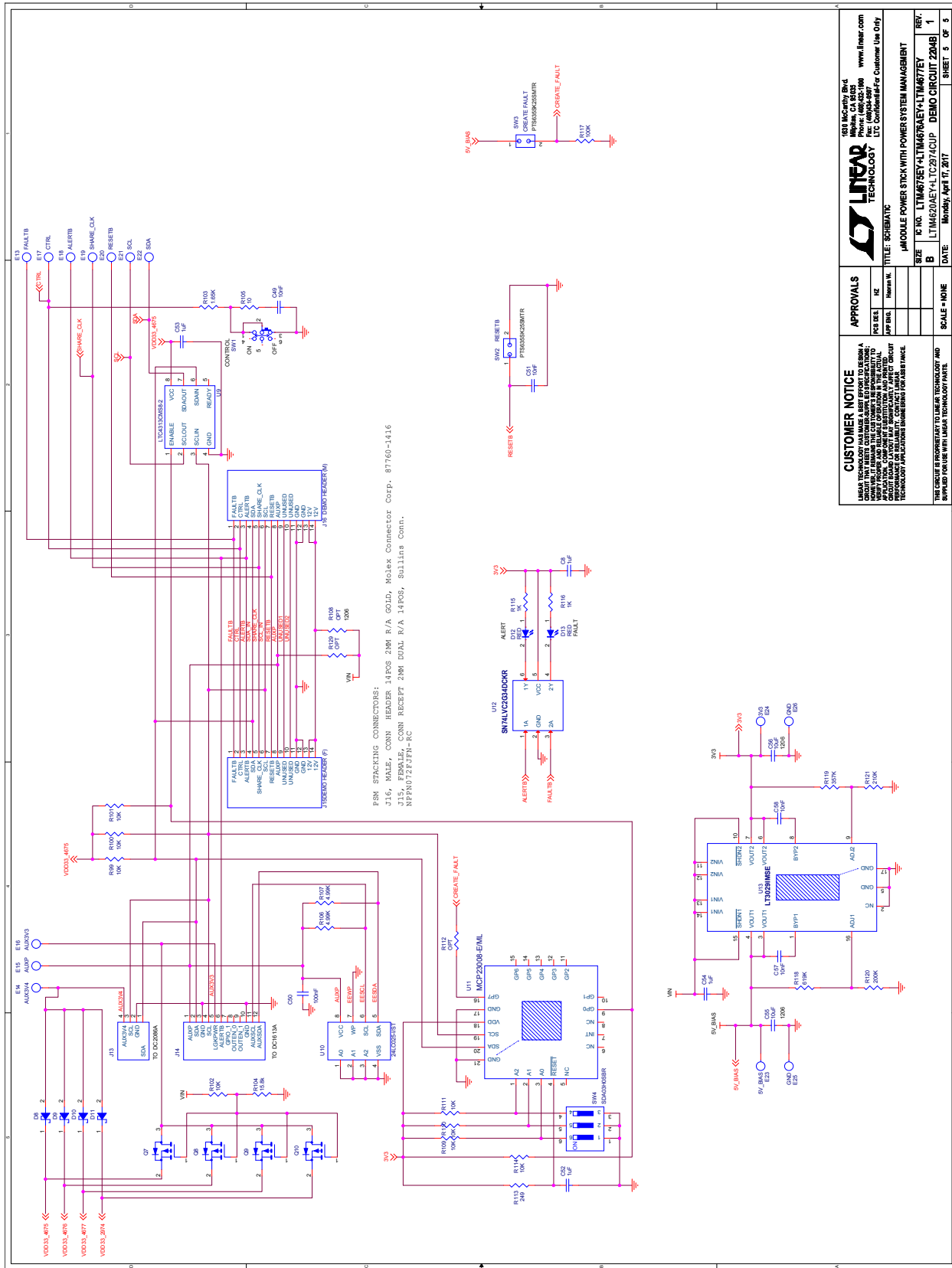

dc2204bf

Information furnished by Linear Technology Corporation is believed to be accurate and reliable. However, no responsibility is assumed for its use. Linear Technology Corporation makes no representation that the interconnection of its circuits as described herein will not infringe on existing patent rights.

DEMO MANUAL DC2204B

DEMONSTRATION BOARD IMPORTANT NOTICE

Linear Technology Corporation (LTC) provides the enclosed product(s) under the following **AS IS** conditions:

This demonstration board (DEMO BOARD) kit being sold or provided by Linear Technology is intended for use for **ENGINEERING DEVELOPMENT OR EVALUATION PURPOSES ONLY** and is not provided by LTC for commercial use. As such, the DEMO BOARD herein may not be complete in terms of required design-, marketing-, and/or manufacturing-related protective considerations, including but not limited to product safety measures typically found in finished commercial goods. As a prototype, this product does not fall within the scope of the European Union directive on electromagnetic compatibility and therefore may or may not meet the technical requirements of the directive, or other regulations.

If this evaluation kit does not meet the specifications recited in the DEMO BOARD manual the kit may be returned within 30 days from the date of delivery for a full refund. **THE FOREGOING WARRANTY IS THE EXCLUSIVE WARRANTY MADE BY THE SELLER TO BUYER AND IS IN LIEU OF ALL OTHER WARRANTIES, EXPRESSED, IMPLIED, OR STATUTORY, INCLUDING ANY WARRANTY OF MERCHANTABILITY OR FITNESS FOR ANY PARTICULAR PURPOSE. EXCEPT TO THE EXTENT OF THIS INDEMNITY, NEITHER PARTY SHALL BE LIABLE TO THE OTHER FOR ANY INDIRECT, SPECIAL, INCIDENTAL, OR CONSEQUENTIAL DAMAGES.**

The user assumes all responsibility and liability for proper and safe handling of the goods. Further, the user releases LTC from all claims arising from the handling or use of the goods. Due to the open construction of the product, it is the user's responsibility to take any and all appropriate precautions with regard to electrostatic discharge. Also be aware that the products herein may not be regulatory compliant or agency certified (FCC, UL, CE, etc.).

No License is granted under any patent right or other intellectual property whatsoever. **LTC assumes no liability for applications assistance, customer product design, software performance, or infringement of patents or any other intellectual property rights of any kind.**

LTC currently services a variety of customers for products around the world, and therefore this transaction **is not exclusive**.

Please read the DEMO BOARD manual prior to handling the product. Persons handling this product must have electronics training and observe good laboratory practice standards. **Common sense is encouraged.**

This notice contains important safety information about temperatures and voltages. For further safety concerns, please contact a LTC application engineer.

Mailing Address:

Linear Technology
1630 McCarthy Blvd.
Milpitas, CA 95035

Copyright © 2004, Linear Technology Corporation

Компания «Океан Электроники» предлагает заключение долгосрочных отношений при поставках импортных электронных компонентов на взаимовыгодных условиях!

Наши преимущества:

- Поставка оригинальных импортных электронных компонентов напрямую с производств Америки, Европы и Азии, а так же с крупнейших складов мира;
- Широкая линейка поставок активных и пассивных импортных электронных компонентов (более 30 млн. наименований);
- Поставка сложных, дефицитных, либо снятых с производства позиций;
- Оперативные сроки поставки под заказ (от 5 рабочих дней);
- Экспресс доставка в любую точку России;
- Помощь Конструкторского Отдела и консультации квалифицированных инженеров;
- Техническая поддержка проекта, помощь в подборе аналогов, поставка прототипов;
- Поставка электронных компонентов под контролем ВП;
- Система менеджмента качества сертифицирована по Международному стандарту ISO 9001;
- При необходимости вся продукция военного и аэрокосмического назначения проходит испытания и сертификацию в лаборатории (по согласованию с заказчиком);
- Поставка специализированных компонентов военного и аэрокосмического уровня качества (Xilinx, Altera, Analog Devices, Intersil, Interpoint, Microsemi, Actel, Aeroflex, Peregrine, VPT, Syfer, Eurofarad, Texas Instruments, MS Kennedy, Miteq, Cobham, E2V, MA-COM, Hittite, Mini-Circuits, General Dynamics и др.);

Компания «Океан Электроники» является официальным дистрибьютором и эксклюзивным представителем в России одного из крупнейших производителей разъемов военного и аэрокосмического назначения «JONHON», а так же официальным дистрибьютором и эксклюзивным представителем в России производителя высокотехнологичных и надежных решений для передачи СВЧ сигналов «FORSTAR».



JONHON

«JONHON» (основан в 1970 г.)

Разъемы специального, военного и аэрокосмического назначения:

(Применяются в военной, авиационной, аэрокосмической, морской, железнодорожной, горно- и нефтедобывающей отраслях промышленности)

«FORSTAR» (основан в 1998 г.)

ВЧ соединители, коаксиальные кабели, кабельные сборки и микроволновые компоненты:

(Применяются в телекоммуникациях гражданского и специального назначения, в средствах связи, РЛС, а так же военной, авиационной и аэрокосмической отраслях промышленности).



Телефон: 8 (812) 309-75-97 (многоканальный)

Факс: 8 (812) 320-03-32

Электронная почта: ocean@oceanchips.ru

Web: <http://oceanchips.ru/>

Адрес: 198099, г. Санкт-Петербург, ул. Калинина, д. 2, корп. 4, лит. А