

PANDUIT®

Panduit® StrongHold™ Electrical/Network Supports and Fasteners



Strong Hold™

Electrical/Network Supports and Fasteners

Contractor Solutions

for Electrical and Networking Installations

Panduit is committed to providing our contractor partners a comprehensive portfolio of products, programs, and services to help increase job site productivity, improve back-office operations, and accelerate cash flow. Our collaborative approach addresses the greatest business challenges for the contractor community, and provides a competitive advantage in your market space.

Solutions

- Whether the solution is for electrical or networking systems, Panduit offers a unique understanding of the complexities of infrastructure construction
- We continually offer new application systems focused on meeting the ever-changing installation and maintenance needs of our customers

Programs*

- The Panduit Business Partner Program offers a variety of benefits designed to help increase effectiveness, address the business needs of customers, and grow overall profitability
- Our JobSight™ Program is a prescriptive planning and inventory management program that provides visibility throughout all levels of the supply chain to increase service levels and keep projects on schedule

Services

- The Mobile Access Guide immediately provides information required to keep your project moving when working on-site or from most any remote location
- Extensive website with product specifications, installation guides, part drawings and more, to make your job easier
- World-class customer service and product availability keep your projects on time and within budget

*For complete program details, go to www.panduit.com or contact Customer Service at 800.777.3300. All programs and benefits subject to terms and conditions.

StrongHold™ Electrical/Network Supports and Fasteners

Panduit electrical/network supports and fasteners provide a reliable, high-quality solution for routing and securing power and communication cabling within commercial and industrial facilities.

StrongHold™ Supports and Fasteners are designed to meet the regulatory requirements of NFPA 70 (National Electric Code), UL standards, and other USA/Canadian building codes.



SECTION INDEX: Click on any section below to go to that portion of the catalog

Table of Contents

A. Cable/Conduit Pages A.1 – A.18

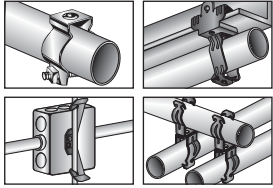
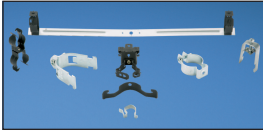

B. Beam/Purlin Pages B.1 – B.12

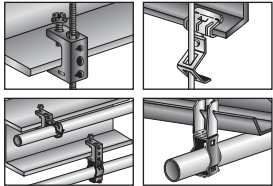
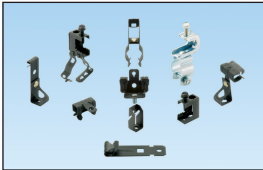

C. Hangers/Hanging System Pages C.1 – C.2

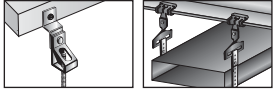

D. Stud Wall Pages D.1 – D.18

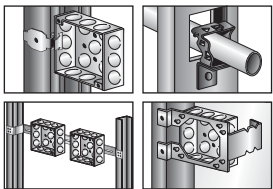

E. Communication/ Low Voltage Pages E.1 – E.14

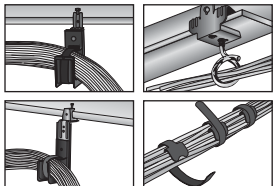

Sample product applications; for more information see product sections.

Table of Contents

F. Dry Wall Pages F.1 – F.2

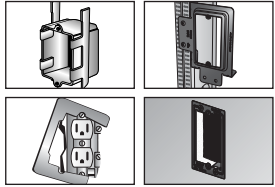

G. Acoustical Pages G.1 – G.10

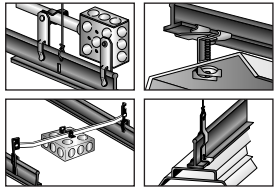

H. Miscellaneous Pages H.1 – H.4

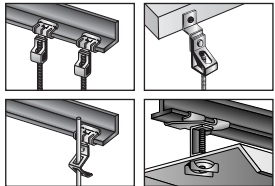

**J. Sizing Information
Reference Pages J.1 – J.8**

**K. Codes and Standards
Reference Pages K.1 – K.20**

L. Part Number Index Pages L.1 – L.4

Related Products

Identification and Labeling Solutions



A global leader in reliable and innovative solutions for identification and safety, Panduit offers a complete leading-edge line of labeling software, high-performance label materials (all RoHS compliant), and printers that provide enhanced productivity, dependability, and value to all infrastructure labeling requirements.

Cable Ties



Panduit offers a full line of cable ties and cable management accessories to bundle, route, and identify cable in a variety of applications. With our comprehensive selection of cable ties and accessory products, Panduit provides innovative solutions to meet various application environments, customer needs, and industry standards.

Termination Solutions



Panduit termination solutions are designed and manufactured to meet stringent industry standards and deliver superior electrical performance. These solutions include a wide assortment of power connectors, terminals, and tools to provide high-quality terminations. Engineered to improve productivity and reduce downtime, Panduit terminations meet customer needs while maintaining quality and reliability.

Related Products

Grounding

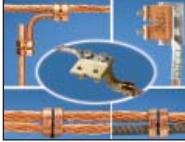

The complete selection of Panduit compression and mechanical grounding connectors provides high-quality, fast, and safe connections. Each part works with a range of wire sizes and combinations to help minimize inventory requirements and save cost. Connectors meet all applicable grounding and bonding approvals to ensure high performance and reliability. Direct Burial Grounding System meets the stringent requirements of IEEE Std. 837-2002 for corrosion resistance.

Stainless Steel

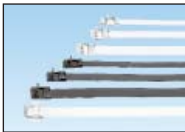

Panduit stainless coated and uncoated cable ties, banding, strapping, accessories, and tooling provide a strong, durable method of bundling and mechanical fastening for all indoor, outdoor, and underground applications.

Permanent Identification



Safe, quick, and easy to install, Panduit permanent identification solutions include stainless steel and aluminum marker plates, tags, and marking tools and ties to deliver improved productivity and workplace safety. Panduit permanent identification solutions withstand the test of time and provide legibility in harsh environments.

Related Products

Safety Solution



The Panduit safety solution includes the product systems (lockout devices, facility safety signage, labels and software), as well as expertise in workplace safety compliance (services and training DVD) to help customers understand and comply with workplace safety regulations. These safety-compliant systems offer a comprehensive workplace safety solution to aid customers in compliance with OSHA standards.



Routing/Pathways



Surface raceway and wiring duct are designed to route, conceal, manage, and protect cabling and wiring. Panduit offers a wide selection of styles, sizes, colors, and materials to meet a variety of application and environmental needs.



Overhead Routing Systems



Wyr-Grid® Overhead Cable Tray Routing System is designed to route and manage copper data cables, fiber optic cables, or power cables. FiberRunner® Routing System is designed to segregate, route, and protect fiber optic and high-performance copper cabling.



Related Products

Tools



Speed installation, maximize productivity, and decrease the risk of downtime with reliable Panduit tools for crimping, bundling, cutting, etc.



NetKey® Network Components



The NetKey® Copper and Fiber Cabling System provides a complete, standards-compliant cabling infrastructure solution for voice, data, and video applications. NetKey® Modules feature the universal “keystone” design and are compatible with a wide assortment of modular patch panels, faceplates, and surface mount boxes. When teamed with complementary Panduit products, NetKey® Solutions cover all needs from the telecommunications room to the work area with proven innovation and quality.



Notes

Cable/Conduit

Snap-Close Conduit Clips



Image 1



Image 2

- No fastener required to retain conduit
- Static load capacity:
 - 100 lbs. in vertical position
 - 25 lbs. in horizontal position



Part Number	Image No.	Fits EMT/ Rigid/IMC (In.)	Mounting Hole (In.)	Std. Pkg. Qty.
P6M	1	3/8*	1/4 non-threaded	100
P16M	1	1		100
P20M	1	1 1/4		100
P24M	1	1 1/2		100
P812M	1	1/2 – 3/4		100
P812M4I**	2	1/2 – 3/4	1/4-20 threaded	100
P32M	1	2	1/4 non-threaded	100

*Or 14-2 through 12-3 MC/AC cable.

**Not UL or cUL listed.

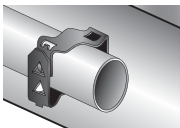

Beam/Purlin

Hangers/Hanging
Systems

Stud Wall

Communication/
Low Voltage

Dry Wall

Acoustical

Miscellaneous

Sizing Information
Reference

Codes & Standards
Reference

Index

Push-Fit Conduit Clips



- No fastener required to retain conduit
- Static load capacity:
 - 25 lbs. in vertical position
 - 15 lbs. in horizontal position
- Available with 1/4" non-threaded mounting hole

Part Number	Fits EMT (In.)	Fits Rigid/IMC (In.)	Std. Pkg. Qty.
P8P	1/2	—	100
P12P	3/4	1/2	100
P16P	1	3/4	100

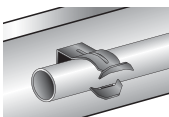

Conduit Clamps with Bolt



- Conduit hanger available for 1/2" – 4" conduit
- Bolt and nut (Phillips/flathead) provide positive securing feature
- Available with threaded and non-threaded mounting hole



Part Number	Fits EMT (In.)	Fits Rigid/IMC (In.)	Mounting Hole (In.)	Std. Pkg. Qty.
PCD0B	1/2	3/8 – 1/2	1/4 non-threaded	100
PCD1B	3/4	3/4	1/4 non-threaded	100
PCD2B	1	1	1/4 non-threaded	100
PCD2.5B	1 1/4	—	1/4 non-threaded	100
PCD3B	1 1/2	1 1/4	1/4 non-threaded	100
PCD4B	—	1 1/2	5/16 non-threaded	100
PCD5B	2	2	5/16 non-threaded	50
PCD6B	2 1/2	2 1/2	5/16 non-threaded	50
PCD7B	3	3	5/16 non-threaded	25
PCD8B	3 1/2	3 1/2	5/16 non-threaded	25
PCD9B	4	4	1/2 non-threaded	10

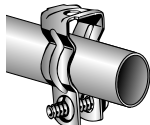
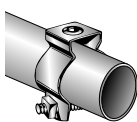

Order number of pieces required, in multiples of Standard Package Quantity.

Snap-Close Conduit Clips with Beam Clamps – Bottom Mount



- Suspend conduit from bottom of beam
- Will pivot 360°
- Hammer-on installation
- Static load capacity: 75 lbs. vertically



Part Number	Flange Thickness (In.)	Fits EMT/Rigid/IMC (In.)	Std. Pkg. Qty.
P6M24	1/8 – 1/4	3/8	100
P6M58	5/16 – 1/2	3/8	100
P6M912	9/16 – 3/4	3/8	100
P812M24	1/8 – 1/4	1/2 – 3/4	100
P812M58	5/16 – 1/2	1/2 – 3/4	100
P812M912	9/16 – 3/4	1/2 – 3/4	100
P16M24	1/8 – 1/4	1	100
P16M58	5/16 – 1/2	1	100
P16M912	9/16 – 3/4	1	100
P20M24	1/8 – 1/4	1 1/4	100
P20M58	5/16 – 1/2	1 1/4	100
P20M912	9/16 – 3/4	1 1/4	100
P24M24	1/8 – 1/4	1 1/2	100
P24M58	5/16 – 1/2	1 1/2	100
P24M912	9/16 – 3/4	1 1/2	100
P32M24	1/8 – 1/4	2	100
P32M58	5/16 – 1/2	2	100
P32M912	9/16 – 3/4	2	100

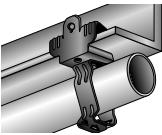

Beam/Purlin

Hangers/Hanging Systems

Stud Wall

Communication/ Low Voltage

Dry Wall

Acoustical

Miscellaneous

Sizing Information Reference

Codes & Standards Reference

Index

PANDUIT®**Snap-Close Conduit Clips with Beam Clamps – Side Mount**

- Suspend conduit from side of beam
- Will pivot 360°
- Hammer-on installation
- Static load capacity: 25 lbs. vertically



Part Number	Flange Thickness (In.)	Fits EMT/Rigid/IMC (In.)	Std. Pkg. Qty.
P6M24SM	1/8 – 1/4	3/8	100
P6M58SM	5/16 – 1/2	3/8	100
P6M912SM	9/16 – 3/4	3/8	100
P812M24SM	1/8 – 1/4	1/2 – 3/4	100
P812M58SM	5/16 – 1/2	1/2 – 3/4	100
P812M912SM	9/16 – 3/4	1/2 – 3/4	100
P16M24SM	1/8 – 1/4	1	100
P16M58SM	5/16 – 1/2	1	100
P16M912SM	9/16 – 3/4	1	100
P20M24SM	1/8 – 1/4	1 1/4	100
P20M58SM	5/16 – 1/2	1 1/4	100
P20M912SM	9/16 – 3/4	1 1/4	100
P24M24SM	1/8 – 1/4	1 1/2	100
P24M58SM	5/16 – 1/2	1 1/2	100
P24M912SM	9/16 – 3/4	1 1/2	100
P32M24SM	1/8 – 1/4	2	100
P32M58SM	5/16 – 1/2	2	100
P32M912SM	9/16 – 3/4	2	100

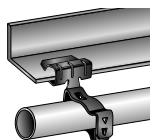

Order number of pieces required, in multiples of Standard Package Quantity.

Push-Fit Conduit Clips with Beam Clamps



Image 1



Image 2

- Available in bottom mount or side mount options
- Will pivot 360°
- Hammer-on installation
- Static load capacity:
 - 25 lbs. vertically for bottom mount (Image 1)
 - 15 lbs. vertically for side mount (Image 2)

Part Number	Image No.	Flange Thickness (In.)	Fits EMT (In.)	Fits Rigid/IMC (In.)	Std. Pkg. Qty.
P8P24	1	1/8 – 1/4	1/2	—	100
P8P58	1	5/16 – 1/2	1/2	—	100
P8P912	1	9/16 – 3/4	1/2	—	100
P12P24	1	1/8 – 1/4	3/4	1/2	100
P12P58	1	5/16 – 1/2	3/4	1/2	100
P12P912	1	9/16 – 3/4	3/4	1/2	100
P16P24	1	1/8 – 1/4	1	3/4	100
P16P58	1	5/16 – 1/2	1	3/4	100
P16P912	1	9/16 – 3/4	1	3/4	100
P8P24SM	2	1/8 – 1/4	1/2	—	100
P8P58SM	2	5/16 – 1/2	1/2	—	100
P8P912SM	2	9/16 – 3/4	1/2	—	100
P12P24SM	2	1/8 – 1/4	3/4	1/2	100
P12P58SM	2	5/16 – 1/2	3/4	1/2	100
P12P912SM	2	9/16 – 3/4	3/4	1/2	100
P16P24SM	2	1/8 – 1/4	1	3/4	100
P16P58SM	2	5/16 – 1/2	1	3/4	100
P16P912SM	2	9/16 – 3/4	1	3/4	100

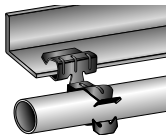
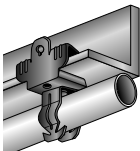

PANDUIT®

Cable Clips



- Support MC, AC, or BX cable from #12 – #8 wire in horizontal or vertical position
- No static load rating – for positioning only
- Can also be used for flexible metallic tubing, armored cable, portable cables, and control tubes
- See chart below for installation configurations



Part Number	Description	Std. Pkg. Qty.
PKX*	Cable clip to support MC, AC, or BX cable from drop wire.	100
PK8	Conduit clip to support 1/2" EMT from drop wire, rod, or flange.	100

*Not UL or cUL listed.

Cable Size (In.)	#12 Wire	#10 Wire	#8 – #9 Wire
14-2 (0.43 – 0.48 O.D.)	PKX	PKX	PKX
14-3 (0.45 – 0.50 O.D.)	PKX	PKX	PKX
12-2 (0.47 – 0.51 O.D.)	PKX	PKX	PKX
12-3 (0.49 – 0.54 O.D.)	PKX	PK8	PK8

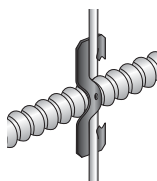

Order number of pieces required, in multiples of Standard Package Quantity.

Conduit Clips



- Support conduit from drop wire, rod, or flange
- No static load rating – for positioning only
- Can also be used for flexible metallic tubing, armored cable, portable cables, and control tubes
- See chart below for installation configurations



Part Number	Description	Std. Pkg. Qty.
PK8	Conduit clip to support 1/2" EMT from drop wire, rod, or flange.	100
PK12	Conduit clip to support 3/4" EMT from drop wire, rod, or flange.	100
PK16*	Conduit clip to support 1" EMT from drop wire, rod, or flange.	100
PK20*	Conduit clip to support 1 1/4" EMT from drop wire, rod, or flange.	100

*Not UL or cUL listed.

Conduit Size (In.)	#10 – #12 Wire	#8 – #9 Wire	3/16" – 1/4" Rod	1/8" – 1/4" Flange	5/16" – 1/2" Flange	9/16" – 3/4" Flange
1/2 EMT	PK8	PK8	PK8	PK8	PK12	PK12
1/2 Rigid	PK8	PK12	PK12	PK12	PK12	PK16
3/4 EMT	PK12	PK12	PK12	PK12	PK16	PK16
3/4 Rigid	PK12	PK12	PK16	PK16	PK20*	PK20*
1 EMT	–	PK16	PK16	PK16	PK20*	PK20*
1 Rigid	–	–	–	PK20*	PK20*	PK20*
1 1/4 EMT	–	PK20	PK20	PK20	–	–

*For horizontal applications only.

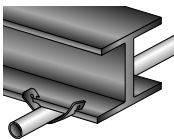

Beam/Purlin

Hangers/Hanging Systems

Stud Wall

Communication/ Low Voltage

Dry Wall

Acoustical

Miscellaneous

Sizing Information Reference

Codes & Standards Reference

Index

Multi-Function Clip Assemblies



Image 1



Image 2



Image 3

- Components and assemblies used to secure conduit and devices to drop wire, rod, or flanges
- P4Z34 and assemblies fit 1/8" – 3/8" flanges and attach to #12 wire through 3/8" rod
- P6Z34 fits 1/8" – 7/16" flanges and attaches to #12 wire through 3/8" rod with improved performance
- No static load rating – for positioning only

Beam/Purlin

Hangers/Hanging Systems

Stud Wall

Communication/
Low Voltage

Dry Wall

Acoustical

Miscellaneous

Part Number	Image No.	Fits EMT (In.)	Fits Rigid/IMC (In.)	Std. Pkg. Qty.
P4Z34*	1	—	—	100
P6Z34	1	—	—	100
P4Z348P	2	1/2	—	100
P4Z3412P	2	3/4	1/2	100
P4Z3416P	2	1	3/4	100
P4Z34812M	3	1/2 – 3/4	1/2 – 3/4	100
P4Z3416M	3	1	1	100

*P4Z34 is UL and cUL listed.

Note: May require dedicated drop wire/rod and PEC311 – consult local authority.

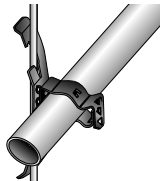
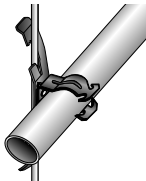
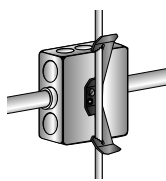

Sizing Information Reference

Codes & Standards Reference

Index

Order number of pieces required, in multiples of Standard Package Quantity.

Conduit-To-Conduit Trapeze Assemblies with Snap-Close Clips



- Designed to quickly secure one conduit run to another
- No fasteners required
- Static load capacity: Total trapeze must not exceed 100 lbs.

Part Number	Fits EMT/Rigid/IMC (In.)	Std. Pkg Qty.
P166M	3/8* to 1	100
P16812M	1/2 – 3/4 to 1	100
P1616M	1 to 1	100
P1620M	1 1/4 to 1	100
P1624M	1 1/2 to 1	100

*Or 14-2 through 12-3 MC/AC cable.

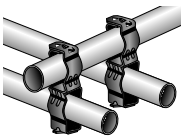

Conduit-To-Conduit Trapeze Assemblies with Push-Fit Clips



- Designed to quickly secure one conduit run to another
- No fasteners required
- Static load capacity: 25 lbs.
- Top conduit to be used for support only

Part Number	Fits EMT (In.)	Fits Rigid/IMC (In.)	Std. Pkg Qty.
P8P8P	1/2 to 1/2	—	100
P8P12P	1/2 to 3/4	—	100
P8P16P	1/2 to 1	—	100
P12P12P	3/4 to 3/4	1/2 to 1/2	100
P12P16P	3/4 to 1	1/2 to 3/4	100
P16P16P	1 to 1	3/4 to 3/4	100

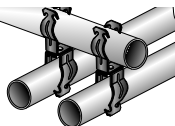

PANDUIT[®]**One-Piece Strut Clamps**

- Used to mount conduit to strut
- All sizes available with load distribution saddle attached to screw to distribute weight
- Suitable for use with standard 1 5/8" strut
- Install with screwdriver, nut driver, or standard wrench



Part Number	Fits EMT (In.)	Fits Rigid/IMC (In.)	Static Load Capacity (Lbs.)	Std. Pkg. Qty.
PSCH6B	3/8	—	—	100
PSCH8B	1/2	—	50	100
PSCH12B	3/4	1/2	50	50
PSCH16B	1	3/4	59	50
PSCH20B	1 1/4	1	75	50
PSCH24B	1 1/2	1 1/4	80	50
PSCH32B	2	1 1/2	100	25
PSCH40B	—	2	80	25
PSCH48B	2 1/2	2 1/2	125	25
PSCH56B	3	3	160	10
PSCH64B	3 1/2	3 1/2	200	10
PSCH72B	4	4	330	10

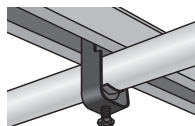

Order number of pieces required, in multiples of Standard Package Quantity.

Universal Strut Clamps



- Break-apart strut clamp
- Install with screwdriver, nut driver, or standard wrench
- Suitable for use with standard 1 5/8" strut
- Material: mild steel

Part Number	Fits EMT/Rigid/IMC (In.)	Static Load Rating (Lbs.)	Std. Pkg. Qty.
PSK85I	1/2	200	100
PSK125I	3/4	200	100
PSK165I	1	200	100
PSK205I	1 1/4	200	100
PSK245I	1 1/2	200	50
PSK325I	2	200	50
PSK405I	2 1/2	350	50
PSK485I	3	350	50
PSK565I	3 1/2	350	25
PSK645I	4	350	25

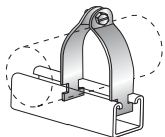

Beam/Purlin

Hangers/Hanging Systems

Stud Wall

Communication/ Low Voltage

Dry Wall

Acoustical

Miscellaneous

Sizing Information Reference

Codes & Standards Reference

Index

Combination Box/Conduit Hangers from Drop Wire, Rod, and Beams



Image 1

- Secure 3/8" conduit (MC/AC cable) and 4" square boxes to most structures
- Provide 3/8" conduit (MC/AC cable) support on both sides of electrical box
- Available in a variety of mounting configurations



Image 2



Image 3



Image 4

Part Number	Image No.	Mounting Method	Fits EMT/Rigid/IMC (In.)	Std. Pkg. Qty.
P6MB18	1	#12 wire through 1/4" flange	3/8*	25
P6MB18A	2	Non-threaded center hole for screw or threaded rod mount	3/8*	25
P812MB18	1	#12 wire through 1/4" rod	1/2 – 3/4	25
P812MB18A	2	Non-threaded center hole for screw or threaded rod mount	1/2 – 3/4	25
P812MB1824	3	1/8" through 1/4" flange	1/2 – 3/4	25

*Or 14-2 through 12-3 MC/AC cable.

Combination Box/Conduit Hangers from Drop Wire, Rod, and Beams (continued)

Part Number	Image No.	Mounting Method	Fits EMT/Rigid/IMC (In.)	Std. Pkg. Qty.
P812MB18S	4	1/4-20 x 9/16" stud in center hole	1/2 – 3/4	25
P16MB18	1	#12 wire through 1/4" rod	1	25
P16MB18A	2	Non-threaded center hole for screw or threaded rod mount	1	25

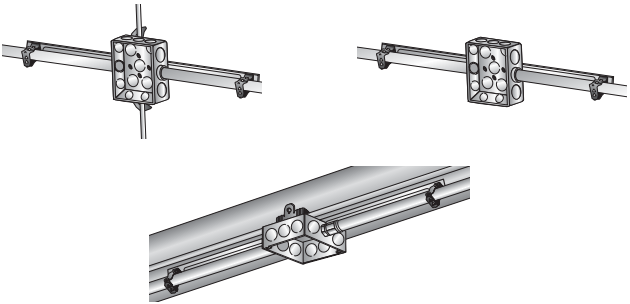

Beam/Purlin

Hangers/Hanging Systems

Stud Wall

Communication/ Low Voltage

Dry Wall

Acoustical

Miscellaneous

Sizing Information Reference

Codes & Standards Reference

Index

PANDUIT[®]**Flexible Conduit/Cable Clips**

- Suitable for flexible conduit and all types of cable
- Support cable from 1/16" – 1/2" flange
- No static load rating – for positioning only
- Clip "snaps" on flange and cable "snaps" into clip

Part Number	AC/MC Cable O.D. (In.)	Flange Size (In.)	Std. Pkg. Qty.
PSC2A	0.22 – 0.28	1/16 – 3/16	100
PSC2B	0.31 – 0.38	1/16 – 3/16	100
PSC2C	0.38 – 0.44	1/16 – 3/16	100
PSC2D	0.47 – 0.56	1/16 – 3/16	100
PSC2E	0.50 – 0.72	1/16 – 3/16	100
PSC2F	0.75 – 0.94	1/16 – 3/16	100
PSC2G	0.97 – 1.25	1/16 – 3/16	100
PSC4A	0.22 – 0.28	3/16 – 9/32	100
PSC4B	0.31 – 0.38	3/16 – 9/32	100
PSC4C	0.38 – 0.44	3/16 – 9/32	100
PSC4D	0.47 – 0.56	3/16 – 9/32	100
PSC4E	0.50 – 0.72	3/16 – 9/32	100
PSC4F	0.75 – 0.94	3/16 – 9/32	100
PSC4G	0.97 – 1.25	3/16 – 9/32	100
PSC8A	0.22 – 0.28	5/16 – 1/2	100
PSC8B	0.31 – 0.38	5/16 – 1/2	100
PSC8C	0.38 – 0.44	5/16 – 1/2	100
PSC8D	0.47 – 0.56	5/16 – 1/2	100
PSC8E	0.50 – 0.72	5/16 – 1/2	100
PSC8F	0.75 – 0.94	5/16 – 1/2	100
PSC8G	0.97 – 1.25	5/16 – 1/2	100

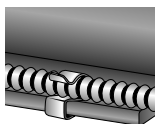

Order number of pieces required, in multiples of Standard Package Quantity.

Flexible Cable Clip



- Push clip to attach MC or AC cable to metal stud
- No tools required for installation
- Provides fast installation

Part Number	Cable Size (In.)	Std. Pkg. Qty.
P449	12-2 (0.47 – 0.51 O.D.)	100
	12-3 (0.49 – 0.54 O.D.)	
	14-2 (0.43 – 0.48 O.D.)	
	14-3 (0.46 – 0.50 O.D.)	

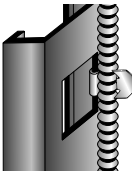

Beam/Purlin

Hangers/Hanging Systems

Stud Wall

Communication/ Low Voltage

Dry Wall

Flexible Conduit/Cable Hangers



- Bundle runs of MC and AC cable
- Can be used with variety of mounting hardware
- Easy to close without the use of tools

Part Number	Description	Ultimate Load (Lbs.)	Std. Pkg. Qty.
PWMX3	Cable hanger for 1 1/8" diameter bundle – 3 runs of MC/AC.	50	100
PWMX6	Cable hanger for 1 3/4" diameter bundle – 6 runs of MC/AC.	75	100

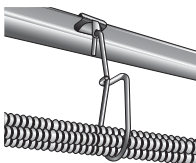

Acoustical

Miscellaneous

Sizing Information Reference

Codes & Standards Reference

Index

Support Brackets for MC/AC Cable



Image 1

- Properly space and support MC/AC cable
- Prevent derating of electrical cable
- Comply with NEC Article 310.15 (reference pages K.4 – K.5 for details)



Image 2

Part Number	Image No.	Capacity	Std. Pkg. Qty.
PMCS50	1	Up to 4 runs of MC/AC cable 0.43" – 0.56" in diameter	100
PMCS100	2	Up to 8 runs of MC/AC cable 0.43" – 0.56" in diameter	50
PMCS101	2	Up to 7 runs of MC/AC cable 0.56" – 0.69" in diameter	50

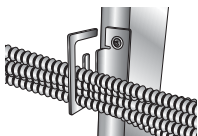

Order number of pieces required, in multiples of Standard Package Quantity.

Nail/Conduit Brackets



Image 1



Image 2

- Attach conduit to wood, steel, and concrete
- Eliminate offset bends on 1 1/2" box
- No static load rating – for positioning only
- May be attached after positioning conduit

Part Number	Image No.	Fits EMT (In.)	Fits Rigid/IMC (In.)	Std. Pkg. Qty.
PCNB812M	1	1/2 – 3/4	1/2 – 3/4	100
PCNB8P	2	1/2	—	100
PCNB12P	2	3/4	1/2	100

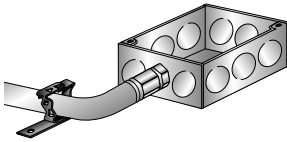

Beam/Purlin

Hangers/Hanging Systems

Stud Wall

Communication/ Low Voltage

Dry Wall

Acoustical

Miscellaneous

Sizing Information Reference

Codes & Standards Reference

Index

Metal Deck/Conduit Brackets



- Provide spacing between conduit and deck surface
- Eliminate offset bends on 2 1/8" box
- No static load rating – for positioning only
- May be attached after positioning conduit

Part Number	Fits EMT (In.)	Fits Rigid/IMC (In.)	Std. Pkg. Qty.
PAOL8P	1/2	—	100
PAOL12P	3/4	1/2	100
PAOL16P	1	3/4	100

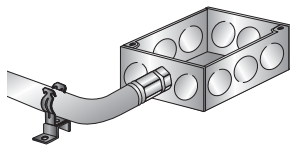

Order number of pieces required, in multiples of Standard Package Quantity.

Beam/Purlin

Screw-On Beam Clamps



PBC

- Attach to beam with screw
- Install with screwdriver, nut driver, or standard wrench
- Incorporate tapped holes to accommodate threaded rod



PBC200



PBC400

Part Number	Flange Thickness (In.)	Tapped Hole	Static Load Rating (Lbs.)	Material	Std. Pkg. Qty.
PBC*	Up to 1/2	1/4-20 in back and bottom; #10-24 in back	100	Spring Steel	100
PBC200	Up to 1/2	1/4-20 in back and bottom	100	Zinc Plated Steel	50
PBC400**	Up to 15/16	3/8-16 in back and bottom	200	Zinc Plated Steel	25

*3/8" non-threaded clearance hole in top and bottom; 1/4" non-threaded clearance hole in back.

**UL and cUL listed.

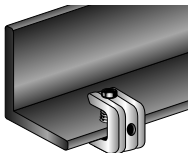
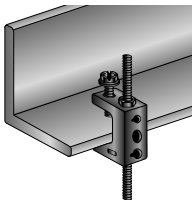

Hammer-On Beam Clamps with Attachment Tab



- Hammer-on installation
- Attachment tab provides 1/4" clearance hole for wire, S-hooks, or chain assemblies
- Static load capacity: 200 lbs.



Part Number	Flange Thickness (In.)	Std. Pkg. Qty.
P4H24	1/8 – 1/4	100
P4H58	5/16 – 1/2	100
P4H912	9/16 – 3/4	100

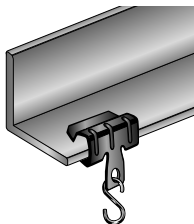

Order number of pieces required, in multiples of Standard Package Quantity.

Hammer-On Beam Clamps



Image 1

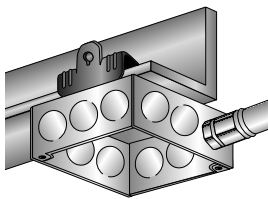
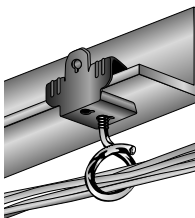

Image 2

- Hammer-on installation
- Provided with a 1/4-20 thread so that boxes, fixtures, and bridle rings may be quickly and securely attached to the beam flanges (Image 1)
- Also available with 1/4-20 x 3/8" staked stud for easier attachment of outlet boxes to beams; eliminates need to use additional screws (Image 2)
- Static load capacity: 75 lbs.



Part Number	Image No.	Flange Thickness (In.)	Std. Pkg. Qty.
PM24	1	1/8 – 1/4	100
PM58	1	5/16 – 1/2	100
PM912	1	9/16 – 3/4	100
PM24S	2	1/8 – 1/4	100
PM58S	2	5/16 – 1/2	100
PM912S	2	9/16 – 3/4	100



Spring Steel Screw-On Beam Clamp Assemblies



Image 1

- Easily attach conduit to beams
- Can be installed on flange up to 1/2" thick
- Include snap-close or push-fit conduit fittings



Image 2

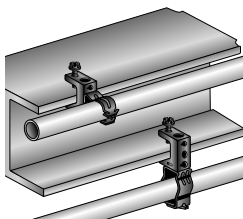

Image 3



Image 4

Part Number	Image No.	Fits EMT (In.)	Fits Rigid/IMC (In.)	Static Load Rating (Lbs.)	Std. Pkg. Qty.
PBC8P	1	1/2	—	25	100
PBC12P	1	3/4	1/2	25	100
PBC16P	1	1	3/4	25	100
PBC8PSM	2	1/2	—	15	100
PBC12PSM	2	3/4	1/2	15	100
PBC16PSM	2	1	3/4	15	100
PBC812M	3	1/2 – 3/4	1/2 – 3/4	100	100
PBC16M	3	1	1	100	100
PBC20M	3	1 1/4	1 1/4	100	100
PBC24M	3	1 1/2	1 1/2	100	100
PBC32M	3	2	2	100	100
PBC812MSM	4	1/2 – 3/4	1/2 – 3/4	25	100
PBC16MSM	4	1	1	25	100
PBC20MSM	4	1 1/4	1 1/4	25	100
PBC24MSM	4	1 1/2	1 1/2	25	100
PBC32MSM	4	2	2	25	100



Order number of pieces required, in multiples of Standard Package Quantity.

Screw-On Beam Clamp Assemblies with Conduit Clamps



- Easily attach conduit to beams up to 1/2" thick
- Conduit clamps provide positive securing feature
- Suitable for EMT or Rigid/IMC conduit

Part Number	Fits EMT (In.)	Fits Rigid/IMC (In.)	Std. Pkg. Qty.
PBC200CD1B	3/4	3/4	100
PBC200CD2B	1	1	100
PBC200CD2.5B	1 1/4	—	100
PBC200CD3B	1 1/2	1 1/4	100
PBC200CD4B	—	1 1/2	50
PBC200CD5B	2	2	50

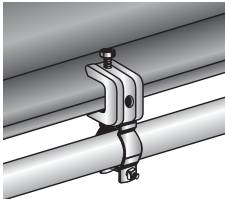

Hammer-On Beam Clamps with Rod Hanger



Image 1

- Hammer-on beam clamps allow for easy installation
- Options available for threaded or non-threaded rod
- Options available for flanges 1/8" – 3/4" thick
- Static load capacity: 160 lbs.



Image 2



Image 3

Part Number	Image No.	Flange Thickness (In.)	Rod Size	Std. Pkg. Qty.
P6TI24	1	1/8 – 1/4	3/8-16 threaded	100
P4TI58	1	5/16 – 1/2	1/4-20 threaded	100
P6TI58	1	5/16 – 1/2	3/8-16 threaded	100
P6TI912	1	9/16 – 3/4	3/8-16 threaded	100
P4TI24	1	1/8 – 1/4	1/4-20 threaded	100
P4TI912	1	9/16 – 3/4	1/4-20 threaded	100
P6TA24*	2	1/8 – 1/4	1/4" – 3/8"; requires nuts	100
P6TA58*	2	5/16 – 1/2	1/4" – 3/8"; requires nuts	100
P6A24	3	1/8 – 1/4	3/8" non-threaded	100
P6A58	3	5/16 – 1/2	3/8" non-threaded	100
P6A912	3	9/16 – 3/4	3/8" non-threaded	100

*UL and cUL listed.

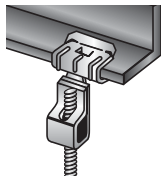
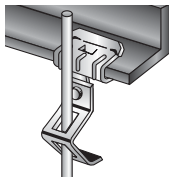

Order number of pieces required, in multiples of Standard Package Quantity.

Purlin Clips – Spring Steel



PVF14



PAF14

- Fasteners fit flanges 1/16" – 1/4" thick
- Support wire and assemblies from vertical or angled flanges
- Hammer-on installation
- Material: spring steel
- Static load capacity: 100 lbs.

Part Number	Flange Orientation	Std. Pkg. Qty.
PVF14	Vertical	100
PAF14	Angled	100

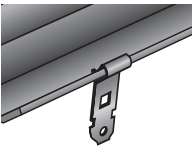

Z-Purlin Clips



P122

- Provide a method for attaching conduit and boxes to angled flanges
- Installed by hand without the use of power tools
- Static load capacity: 100 lbs.



P123

Part Number	Description	Std. Pkg. Qty.
P122	1/4" hole for wire, S-hooks, and jack chain.	100
P123	1/4" hole in bottom for assemblies.	100

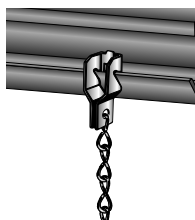
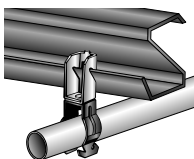

Order number of pieces required, in multiples of Standard Package Quantity.

Purlin Clip Assemblies for Threaded Rod and Drop Wire Applications



- Suspend threaded rod and drop wire from vertical flange
- Hammer-on installation
- Material: spring steel
- Static load capacity: 160 lbs.
- Flange thickness: 1/16" – 5/32"

Part Number	Rod Size	Std. Pkg. Qty.
PVF144TI	1/4-20 threaded	100
PVF146TI	3/8-16 threaded	100
PVF146T	1/4" – 3/8" requires nuts	100

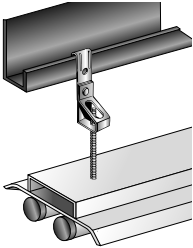

Z-Purlin Clip Assemblies for Conduit Applications



Image 1

- Provide a method for attaching conduit to angled flanges
- Installed by hand without the use of power tools



Image 2

Part Number	Image No.	Fits EMT (In.)	Fits Rigid/IMC (In.)	Static Load Rating (Lbs.)	Std. Pkg. Qty.
P1238P	1	1/2	—	25	100
P12312P	1	3/4	1/2	25	100
P12316P	1	1	3/4	25	100
P1236M	2	3/8	3/8	100	100
P123812M	2	1/2 – 3/4	1/2 – 3/4	100	100
P12316M*	2	1	1	100	100
P12320M	2	1 1/4	1 1/4	100	100

*UL and cUL listed.

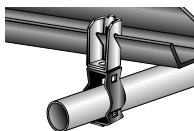
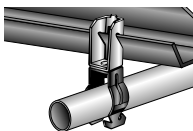

Order number of pieces required, in multiples of Standard Package Quantity.

Z-Purlin Clip Assemblies for Threaded Rod and Drop Wire Applications



Image 1

- Provide a method for attaching conduit and boxes to angled flanges
- Installed by hand without the use of power tools
- Static load capacity: 100 lbs.



Image 2

Part Number	Image No.	Rod Size	Std. Pkg. Qty.
P1224TI	1	1/4-20 threaded	100
P1226TI	1	3/8-16 threaded	100
P1226T	2	1/4" – 3/8" threaded; requires nuts	100

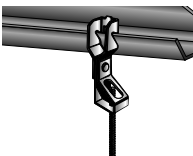

Notes

Hangers/Hanging Systems

Rod and Wire Hangers with Bracket Supports



Image 1

- Suspend #8 wire, 1/4", and 3/8" non-threaded or threaded rod from overhead mountings
- 1/4" clearance hole in right angle and offset brackets
- Static load capacity: 160 lbs.



Image 2



Image 3

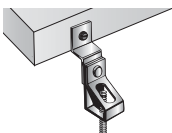

Image 4



Image 5

Part Number	Image No.	Rod Size	Bracket Orientation	Std. Pkg. Qty.
P4TIB	1	1/4-20 threaded rod	Right Angle	100
P6TIB	1	3/8-16 threaded rod	Right Angle	100
P6TB	2	1/4" – 3/8" threaded rod; requires nut	Right Angle	100
P6AO	3	3/8 non-threaded rod	Offset	100
P4TIO	4	1/4-20 threaded rod	Offset	100
P6TIO	4	3/8-16 threaded rod	Offset	100
P6TO	5	1/4" – 3/8" threaded rod; requires nut	Offset	100



Strap Hangers



Image 1

- Support pipe or duct from flange with banding or strapping up to 1" wide
- Options available for beams 1/8" – 3/4" thick
- Hammer-on installation
- Static load capacity: 200 lbs.



Image 2



Part Number	Image No.	Flange Thickness (In.)	Std. Pkg. Qty.
PMSS24	1	1/8 – 1/4	100
PMSS58	1	5/16 – 1/2	100
PMSS912	1	9/16 – 3/4	100
PMSR24	2	1/8 – 1/4	100
PMSR58	2	5/16 – 1/2	100
PMSR912	2	9/16 – 3/4	100

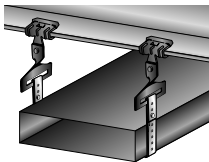

Order number of pieces required, in multiples of Standard Package Quantity.

Stud Wall

Electrical Box Mounting Support Brackets



Image 1

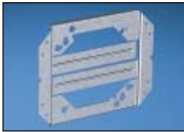
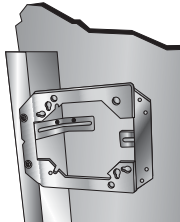
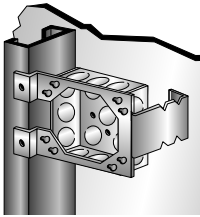

Image 2

- Attach 4" or 4 11/16" electrical outlet boxes to studs
- Support feature reduces box movement in wall
- Manufactured from pre-galvanized steel
- Comply with NEC Article 300.4 (D) (reference pages K.1 – K.2 for details)

Part Number	Image No.	Stud Depth (In.)	Std. Pkg. Qty.
PH23	1	2 1/2 and 3 1/2	100
PH4	1	2 1/2, 3 1/2, and 4	100
PH6	1	6	100
PMEB1	2	2 1/2, 3 1/2, and 4	25



Screw-On Conduit Supports



- Comply with NEC Article 358.30 to support conduit close to electrical box
- Accommodate EMT and MC/AC cable
- Allow conduit to align with box knockouts when used with PH series brackets (see page D.1)



Part Number	Fits EMT (In.)	Electrical Box Depth	Color	Std. Pkg. Qty.
PCS16	1	2 1/8	Black	100
PCS812*	1/2 – 3/4	1 1/2	Black	100
PCS812D	1/2 – 3/4	2 1/8	Silver	100

*Not UL or cUL listed.

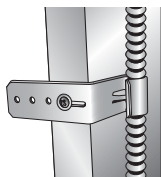

Press-On Nail Plate



- Fast installation; no tools required
- Protects electrical, datacom, and plumbing infrastructure
- Meets NEC Article 300.4 requirements (reference pages K.1 – K.2 for details)

Part Number	Description	Std. Pkg. Qty.
P304B2	Press-on nail plate for wood or metal studs.	100

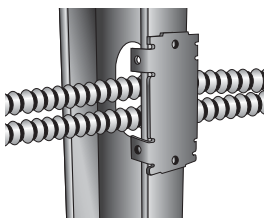

Order number of pieces required, in multiples of Standard Package Quantity.

Hammer-On Box to Stud Supports



PMSF

- Secure electrical boxes to most metal studs
- Include 1/4" hole to secure to stud with user-supplied screw
- Hammer-on installation



PMFS



PMFO

Part Number	Description	Std. Pkg. Qty.
PMSF	Box to stud support – non-adjustable.	100
PMFS	Box to stud support with screw, adjustable for 1/4" – 3/4" dry wall.	100
PMFO	Box to stud support flush to stud face – preset.	100

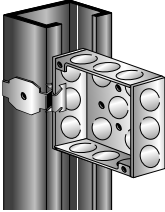

PANDUIT[®]

Switch Box to Metal Stud Brackets



- Secure electrical boxes to most metal studs
- Preset versions offset for specific dry wall thickness
- Include 1/4" hole to secure to stud with user-supplied screw
- Hammer-on installation

Part Number	Dry Wall Thickness (In.)	Std. Pkg. Qty.
PMF250	1/4	100
PMF375	3/8	100
PMF500	1/2	100
PMF625	5/8	100
PMF750	3/4	100

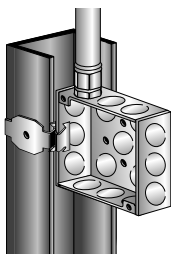

Order number of pieces required, in multiples of Standard Package Quantity.

Hammer-On Conduit to Metal Stud Brackets



Image 1



Image 2

- Designed to quickly install horizontal runs of conduit to metal studs
- Available in push-fit (Image 1) or snap-close (Image 2) fittings
- Suitable for both EMT and Rigid/IMC conduit

Part Number	Image No.	Fits EMT (In.)	Fits Rigid/IMC (In.)	Std. Pkg. Qty.
P8PF	1	1/2	—	100
P12PF	1	3/4	1/2	100
P16PF	1	1	3/4	100
P6MF	2	3/8	3/8	100
P812MF	2	1/2 – 3/4	1/2 – 3/4	100
P16MF	2	1	1	100

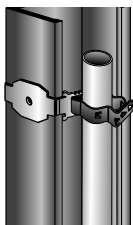
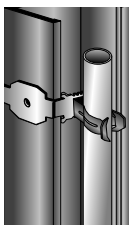

PANDUIT[®]

Screw-On Box to Stud Support



- Installs to stud with user-supplied screws
- For use with metal or wood studs
- Used independently or with assemblies for electrical box or conduit support

Part Number	Description	Std. Pkg. Qty.
P350	Screw-mounted box to stud support.	100

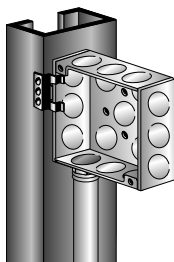

Order number of pieces required, in multiples of Standard Package Quantity.

Screw-On Conduit to Stud Supports



Image 1



Image 2

- Designed to install runs of conduit to metal studs
- Suitable for EMT and Rigid/IMC conduit
- Available in push-fit (Image 1) or snap-close (Image 2) fittings

Part Number	Image No.	Fits EMT (In.)	Fits Rigid/IMC (In.)	Std. Pkg. Qty.
P3508P	1	1/2	—	100
P35012P	1	3/4	1/2	100
P35016P	1	1	3/4	100
P350812M	2	1/2 – 3/4	1/2 – 3/4	100
P35016M	2	1	1	100

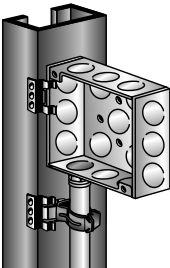

Far-Side Box Supports

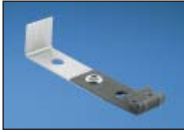

Image 1

- Clip to electrical box to utilize dry wall on far side of box for support
- Used with 1 1/2" or 2 1/8" deep electrical box
- Prevent electrical box from recessing into wall cavity
- No static load rating – for positioning only



Image 2



Image 3

Part Number	Image No.	Figure No.	Stud Depth (In.)	Std. Pkg. Qty.
PJ1A25	1	1	2 1/2	100
PJ1A35	1	1	3 1/2	100
PJ1A4	1	1	4	100
PJ1A6	1	1	6	100
P766	2	1	2 1/2 – 4	100
P766PMD	3	2	3 5/8	100

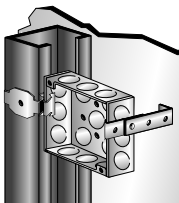

Figure 1

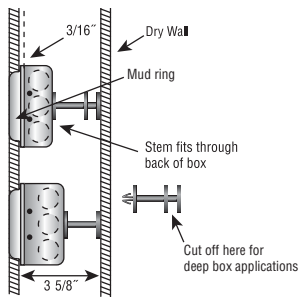

Figure 2

Adjustable Screw Gun Box Mounting Brackets



- Adjustable to allow variability between stud spacing
- Utilized to mount electrical box between studs
- Suitable for 1 1/2" or 2 1/8" deep electrical boxes



Part Number	Description	Std. Pkg. Qty.
PTSGB16	Mount box between studs spaced 11" – 18".	50
PTSGB24	Mount box between studs spaced 17" – 26".	50

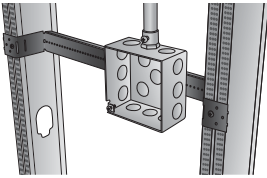

Rigid Box Mounting Brackets

**PRBS16**

- Used to secure multiple electrical boxes in stud walls
- Mount 1 1/2" or 2 1/8" deep electrical boxes
- Suitable for 4" or 4 11/16" wide electrical boxes

**PRBS24**

Part Number	Description	Std. Pkg. Qty.
PRBS16	Rigid box mounting bracket for 16" stud spacing; capacity of three electrical boxes.	50
PRBS24	Rigid box mounting bracket for 24" stud spacing; capacity of four electrical boxes.	25

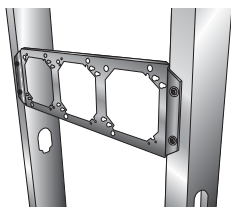

Order number of pieces required, in multiples of Standard Package Quantity.

Stud-Mounted Box Support Brackets



PSGB16A

- User-supplied self-tapping screws attach box to bracket
- Manufactured from pre-galvanized steel

Part Number	Description	Std. Pkg. Qty.
PSGB16A	Mounts 2 1/2" deep electrical boxes to studs on 16" centers.	50
PSGB24A	Mounts 2 1/2" deep electrical boxes to studs on 24" centers.	50

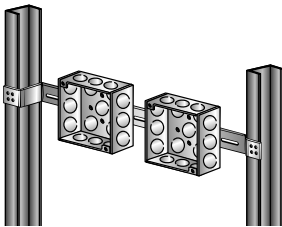

Floor-Mounted Box Support Bracket – Variable Height

- Bracket to support electrical boxes from floor or channels
- Break-away feature allows product to be used at three heights
- Manufactured from pre-galvanized steel

Part Number	Description	Std. Pkg. Qty.
PFBS18	Box support bracket to mount electrical boxes at 12", 16", or 18" heights.	50

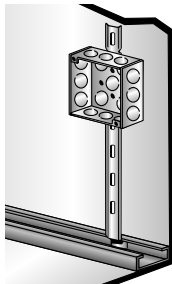

Floor-Mounted Box Bracket



- Supports electrical box at consistent spacing from floor level
- Features can be used to prevent electrical box from being pushed into wall cavity
- Mounts 4" or 4 11/16" wide electrical boxes; 1 1/2" or 2 1/8" deep
- Meets ADA (Americans with Disabilities Act) accessibility guidelines/standards

Part Number	Description	Std. Pkg. Qty.
PFMBS18	Floor-mounted box bracket to mount center of electrical box 18" off floor.	25

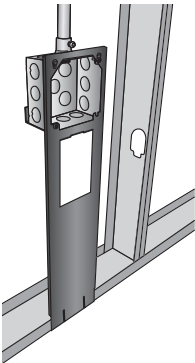

Cable Support Clip



- Used to maintain appropriate cable spacing behind dry wall to comply with NEC Article 300.4 (D) (reference pages K.1 – K.2 for details)
- Attaches to wood or metal stud with user-supplied screws
- Accommodates a variety of cable types

Part Number	Description	Std. Pkg. Qty.
PCJ6	Cable support clip to provide 1 1/2" spacing for cables behind dry wall.	100

Cable Type	Cables Per Clip	Cable Size
Non-metallic	6	14-2, 12-2, 10-2, 14-3, 12-3, 10-3 with ground
Non-metallic	4	8-2, 6-2 with ground
MC/AC	4	14-2, 12-2, 10-2, 14-3, 12-3, 10-3, 14-4, 12-4, 10-4 with ground

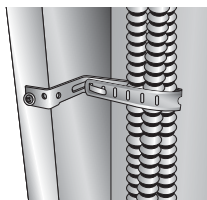

Order number of pieces required, in multiples of Standard Package Quantity.

Cable Support Clip for Single Cable



- Used to maintain appropriate cable spacing behind dry wall to comply with NEC Article 300.4 (D) (reference pages K.1 – K.2 for details)
- Provides 1 1/2" spacing for cables behind dry wall
- Attaches to wood or metal studs with hammer

Part Number	Description	Std. Pkg. Qty.
PFXC20	Accommodates MC/AC cable (12-2 through 10-3).	100

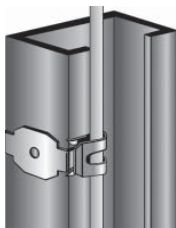

Through-Stud Conduit Supports



Image 1

- Designed to secure horizontal runs of conduit through metal studs
- Eliminate rattling conduit
- Available with push-fit (Image 1) or snap-close (Image 2) conduit fittings



Image 2

Part Number	Image No.	Fits EMT (In.)	Fits Rigid/IMC (In.)	Std. Pkg. Qty.
PFB8P	1	1/2	—	100
PFB12P	1	3/4	1/2	100
PFB6M	2	3/8	3/8	100
PFB812M	2	1/2 – 3/4	1/2 – 3/4	100

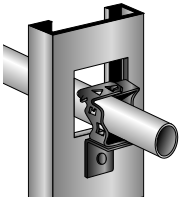

Metal Stud Grommets



MSG-1.3-C



MSGV-1.3-C

- Install in pre-punched hole in metal studs
- Protect cable within the building structure
- Utilize metal stud punch tool (see page D.18) to create suitable holes in specific locations

Part Number	Description	Std. Pkg. Qty.
MSG-1.3-C	Metal stud grommet.	100
MSGV-1.3-C	Metal stud grommet, anti-vibration tabs for 1/2" – 1" pipe.	100

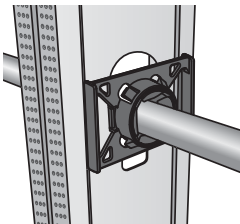

Cable Manager



- Installs in pre-punched hole in metal studs
- Protects cable within the building structure
- Utilizes metal stud punch tool (see page D.18) to create suitable holes in specific locations

Part Number	Description	Std. Pkg. Qty.
CSM-1.25-C	Cable stud manager for 1 1/4" cable spacing.	100

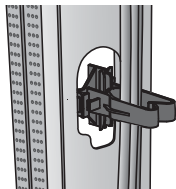

Metal Stud Punch Tool



- Punches 1 11/32" round hole in 25 gauge minimum to 20 gauge maximum mild steel studs
- Contoured handle allows for increased leverage
- Automatic hole centering on standard width (3 5/8") studs
- Replaceable punch and dies
- Self-stripping design that eliminates punch malfunctions

Part Number	Description	Std. Pkg. Qty.
MSPT-1.3	Metal stud punch tool.	1

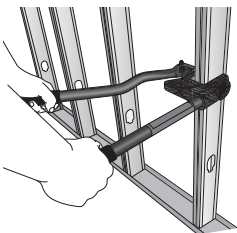

Order number of pieces required, in multiples of Standard Package Quantity.

Communication/Low Voltage

J-Pro™ Series Referenced Images

- UL listed for use in plenum or air handling spaces (such as ceiling voids and underfloor areas) per NEC Article 300.22 (C) and (D) (reference pages K.3 – K.4 for details)
- Complete horizontal and vertical 1" bend radius control



Image 1



Image 2



Image 3



Image 4



Image 5



Image 6



Image 7



Image 8



Image 9



Image 10



Image 11



Image 12

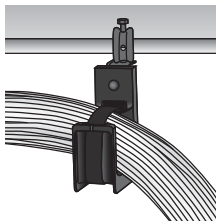

J-Pro™ JP75 Series

- Bundle capacity: 3/4"
- Cable capacity: Category 6A (5), Category 6A (SD) (8), Category 6 (8), Category 5e (10)

Part Number	Image No.	Description	Std. Pkg. Qty.
JP75W-L20	1	Wall mount – one 1/4" mounting hole.	50
JP75WP2B-L20	2	Wall mount for powder actuated fasteners – one 5/32" and one 1/4" mounting hole.	50
JP75CMB-L20	3	Ceiling mount – 3/16", 1/4", and 3/8" mounting holes.	50
JP75DW-L20	4	Drop wire and threaded rod clip mount.	50
JP75SBC50-L20	5	Screw-on beam clamp mount – up to 1/2" flange.	50
JP75SBC50RB-L20	6	Screw-on beam clamp mount – up to 1/2" flange. Rotates 360°.	50
JP75SBC87-L20	7	Screw-on beam clamp mount – up to 3/4" flange.	50
JP75SBC87RB-L20	8	Screw-on beam clamp mount – up to 3/4" flange. Rotates 360°.	50
JP75HBC25RB-L20	9	Hammer-on beam clamp mount – 1/8" - 1/4" flange. Rotates 360°.	50
JP75HBC50RB-L20	9	Hammer-on beam clamp mount – 5/16" – 1/2" flange. Rotates 360°.	50
JP75HBC75RB-L20	9	Hammer-on beam clamp mount – 9/16" – 3/4" flange. Rotates 360°.	50
JP75CP-L20	10	C-purlin clips for straight flanges up to 1/4" thick.	50
JP75ZP-L20	11	Z-purlin clips for angled flanges up to 1/4" thick.	50
JP75UF100-L20	12	Underfloor pedestal support clip for pedestal 7/8" square or 1 1/8" – 1 3/8" in diameter.	50

Order number of pieces required, in multiples of Standard Package Quantity.

J-Pro™ JP131 Series

- Bundle capacity: 1 5/6"
- Cable capacity: Category 6A (15), Category 6A (SD) (25), Category 6 (25), Category 5e (29)

Part Number	Image No.	Description	Std. Pkg. Qty.
JP131W-L20	1	Wall mount – one 1/4" mounting hole.	50
JP131WP2B-L20	2	Wall mount for powder actuated fasteners – one 5/32" and one 1/4" mounting hole.	50
JP131CMB-L20	3	Ceiling mount – 3/16", 1/4", and 3/8" mounting holes.	50
JP131DW-L20	4	Drop wire and threaded rod clip mount.	50
JP131SBC50-L20	5	Screw-on beam clamp mount – up to 1/2" flange.	50
JP131SBC50RBL20	6	Screw-on beam clamp mount – up to 1/2" flange. Rotates 360°.	50
JP131SBC87-L20	7	Screw-on beam clamp mount – up to 3/4" flange.	50
JP131SBC87RBL20	8	Screw-on beam clamp mount – up to 3/4" flange. Rotates 360°.	50
JP131HBC25RBL20	9	Hammer-on beam clamp mount – 1/8" – 1/4" flange. Rotates 360°.	50
JP131HBC50RBL20	9	Hammer-on beam clamp mount – 5/16" – 1/2" flange. Rotates 360°.	50
JP131HBC75RBL20	9	Hammer-on beam clamp mount – 9/16" – 3/4" flange. Rotates 360°.	50
JP131CP-L20	10	C-purlin clips for straight flanges up to 1/4" thick.	50
JP131ZP-L20	11	Z-purlin clips for angled flanges up to 1/4" thick.	50
JP131UF100-L20	12	Underfloor pedestal support clip for pedestal 7/8" square or 1 1/8" – 1 3/8" in diameter.	50

J-Pro™ JP2 Series

- Bundle capacity: 2"
- Cable capacity: Category 6A (30), Category 6A (SD) (46), Category 6 (46), Category 5e (55)

Part Number	Image No.	Description	Std. Pkg. Qty.
JP2W-L20	1	Wall mount – one 1/4" mounting hole.	50
JP2WP2B-L20	2	Wall mount for powder actuated fasteners – one 5/32" and one 1/4" mounting hole.	50
JP2CMB-L20	3	Ceiling mount – 3/16", 1/4", and 3/8" mounting holes.	50
JP2DW-L20	4	Drop wire and threaded rod clip mount.	50
JP2SBC50-L20	5	Screw-on beam clamp mount – up to 1/2" flange.	50
JP2SBC50RB-L20	6	Screw-on beam clamp mount – up to 1/2" flange. Rotates 360°.	50
JP2SBC87-L20	7	Screw-on beam clamp mount – up to 3/4" flange.	50
JP2SBC87RB-L20	8	Screw-on beam clamp mount – up to 3/4" flange. Rotates 360°.	50
JP2HBC25RB-L20	9	Hammer-on beam clamp mount – 1/8" – 1/4" flange. Rotates 360°.	50
JP2HBC50RB-L20	9	Hammer-on beam clamp mount – 5/16" – 1/2" flange. Rotates 360°.	50
JP2HBC75RB-L20	9	Hammer-on beam clamp mount – 9/16" – 3/4" flange. Rotates 360°.	50
JP2CP-L20	10	C-purlin clips for straight flanges up to 1/4" thick.	50
JP2ZP-L20	11	Z-purlin clips for angled flanges up to 1/4" thick.	50
JP2UF100-L20	12	Underfloor pedestal support clip for pedestal 7/8" square or 1 1/8" – 1 3/8" in diameter.	50

Order number of pieces required, in multiples of Standard Package Quantity.

J-Pro™ JP4 Series

- Bundle capacity: 4"
- Cable capacity: Category 6A (115), Category 6A (SD) (180), Category 6 (180), Category 5e (200)

Part Number	Image No.	Description	Std. Pkg. Qty.
JP4W-X20	1	Wall mount – one 1/4" mounting hole.	10
JP4WP2B-X20	2	Wall mount for powder actuated fasteners – one 5/32" and one 1/4" mounting hole.	10
JP4CMB-X20	3	Ceiling mount – 3/16", 1/4", and 3/8" mounting holes.	10
JP4SBC50-X20	5	Screw-on beam clamp mount – up to 1/2" flange.	10
JP4SBC50RB-X20	6	Screw-on beam clamp mount – up to 1/2" flange. Rotates 360°.	10
JP4SBC87-X20	7	Screw-on beam clamp mount – up to 3/4" flange.	10
JP4SBC87RB-X20	8	Screw-on beam clamp mount – up to 3/4" flange. Rotates 360°.	10
JP4HBC25RB-X20	9	Hammer-on beam clamp mount – 1/8" – 1/4" flange. Rotates 360°.	10
JP4HBC50RB-X20	9	Hammer-on beam clamp mount – 5/16" – 1/2" flange. Rotates 360°.	10
JP4HBC75RB-X20	9	Hammer-on beam clamp mount – 9/16" – 3/4" flange. Rotates 360°.	10
JP4CP-X20	10	C-purlin clips for straight flanges up to 1/4" thick.	10
JP4ZP-X20	11	Z-purlin clips for angled flanges up to 1/4" thick.	10
JP4UF100-X20	12	Underfloor pedestal support clip for pedestal 7/8" square or 1 1/8" – 1 3/8" in diameter.	10

J-Pro™ Extension Bracket



- Compatible with 3/4", 1 5/16", and 2" J-Pro™ products
- Allows multiple hooks to be installed utilizing one attachment point
- Includes 1/8", 1/4", and 3/8" mounting holes for various user-supplied hardware

Part Number	Description	Std. Pkg. Qty.
PCATHBA	Multi-tier bracket for J-Pro™ product line.	10



Order number of pieces required, in multiples of Standard Package Quantity.

J-Mod® Series Referenced Images

- UL listed for use in plenum or air handling spaces (such as ceiling voids and underfloor areas) per NEC Article 300.22 (C) and (D) (reference pages K.3 – K.4 for details)
- Complete horizontal and vertical 1" bend radius control



Image 1



Image 2



Image 3



Image 4



Image 5



Image 6



Image 7



Image 8



Image 9



Image 10



Image 11

J-Mod® Series Installation Instructions



Align snap lock attachment of J-hook with holes in chosen bracket and snap J-hook into place.



Align chaining bracket under the assembly.



Slide chaining bracket between J-hook and the metal bracket until it snaps.



Pull down to fully engage.



Attach J-hooks as explained in first-level installation above.



Final assembly is a second-level installation consisting of one threaded rod bracket, one chaining bracket, and two J-hooks for clarity.

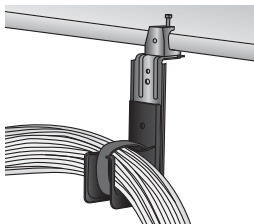

J-Mod® Series

- Bundle capacity: 2"
- Cable capacity: Category 6A (30), Category 6A (SD) (46), Category 6 (46), Category 5e (55)

Part Number	Image No.	Description	Std. Pkg. Qty.
JMJH2W-X20	1	J-hook for wall mount applications only; two 1/4" mounting holes for user supplied screws.	10
JMJH2-X20	2	J-hook for use with J-Mod® brackets.	10
JMCB-X	3	Chaining bracket to extend existing J-Mod® capacity; for use with single-level mounting brackets; three levels maximum.	10
JMCMB25-1-X	4	Single-level ceiling mount bracket with one 1/4" mounting hole.	10
JMCMB25-3-X	5	Three-level ceiling mount bracket with one 1/4" mounting hole.	10
JMDWB-1-X	6	Single-level drop wire bracket that attaches to #12 wire or 1/4" threaded rod.	10
JMDWB-3-X	7	Three-level drop wire bracket that attaches to #12 wire or 1/4" threaded rod.	10
JMTRB38-1-X	8	Single-level threaded rod bracket; accepts 1/4" – 3/8" threaded rod.	10
JMTRB38-3-X	9	Three-level threaded rod bracket; accepts 1/4" – 3/8" threaded rod.	10
JMSBCB87-1-X	10	Single-level screw-on beam clamp bracket for use with flanges up to 3/4" thick.	10
JMSBCB87-3-X	11	Three-level screw-on beam clamp bracket for use with flanges up to 3/4" thick.	10

Hook and Loop Cable Ties



Image 1

- Soft, premium material is safe for use on high-performance communication cable
- UL listed for use in plenum or air handling spaces (such as ceiling voids and underfloor areas) per NEC Article 300.22 (C) and (D) (reference pages K.3 – K.4 for details)

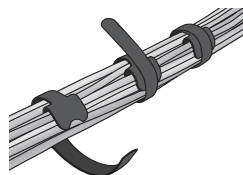

Image 2

- Material flammability rating: UL 94V-2
- Adjustable, releasable, and re-useable multiple times; ideal for moves, adds, and changes



Part Number	Image No.	Length (In.)	Width (In.)	Max. Bundle Dia. (In.)	Color	Std. Pkg. Qty.
HLTP2I-X12	1	8.00	0.50	1.91	Maroon	10
HLTP3I-X12	1	12.00	0.50	3.18	Maroon	10
HLTP2I-X0	1	8.00	0.50	1.91	Black	10
HLTP3I-X0	1	12.00	0.50	3.18	Black	10
HLSP1.5S-X12	2	6.00	0.75	1.50	Maroon	10
HLSP3S-X12	2	12.00	0.75	3.20	Maroon	10
HLSP5S-X12	2	18.00	0.75	5.00	Maroon	10
HLSP1.5S-X0	2	6.00	0.75	1.50	Black	10
HLSP3S-X0	2	12.00	0.75	3.20	Black	10
HLSP5S-X0	2	18.00	0.75	5.00	Black	10



Contractor Grade Hook and Loop Cable Ties



Image 1



Image 2

- Strong, low-profile, flexible material that is safe to use on high-performance cabling
- Cost-effective for general bundling
- Leaves no residue
- HLTT products include an adhesive on the leading edge to facilitate installing hook and loop with one hand
- Color: Black

Part Number	Image No.	Length	Width (In.)	Max. Bundle Dia. (In.)	Std. Pkg. Qty.
TTS-20R0	1	20.00"	0.75	Various	1 pkg. of 1 roll
TTS-35R3-0	1	35.00"	0.75	Various	1 pkg. of 3 rolls
TTS-35RX0	1	35.00"	0.75	Various	1 pkg. of 10 rolls
HLTT1.5S-Q20	2	7.00'	0.75	1.50	25 ties
HLTT1.5S-C20	2	7.00'	0.75	1.50	100 ties

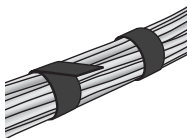

Bridle Rings Referenced Images

Image 1



Image 2



Image 3



Image 4



Image 5



Image 6

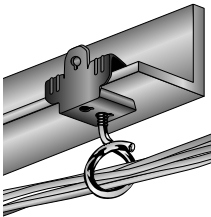

Bridle Rings

- Suitable for low-voltage cabling
- Not suitable for high-performance communication cabling
- Variety of mounting options available to support specific application requirements

Part Number	Image No.	Description	Std. Pkg. Qty.
BR-.50	1	1/2" capacity – #8 wire.	100
BR-.75	1	3/4" capacity – #8 wire.	100
BR-1.25	1	1 1/4" capacity – #8 wire.	100
BR-2.0	1	2" capacity – #8 wire.	100
BR-.50-10-24	2	1/2" capacity – mounts with 10-24 threads.	100
BR-.75-10-24	2	3/4" capacity – mounts with 10-24 threads.	100
BR-1.25-10-24	2	1 1/4" capacity – mounts with 10-24 threads.	100
BR-2.0-10-24	2	2" capacity – mounts with 10-24 threads.	100
BR-1.25-1/4-20	2	1 1/4" capacity – mounts with 1/4"-20 threads.	100
BR-2.0-1/4-20	2	2" capacity – mounts with 1/4"-20 threads.	100
BR-4.0-1/4-20	2	4" capacity – mounts with 1/4"-20 threads.	100
BR-1.25-14WS	3	1 1/4" capacity – mounts with #14 wood screw thread.	100
BR-2.0-14WS	3	2" capacity – mounts with #14 wood screw thread.	100
BR-1.5-PAF	4	1 1/2" capacity – mounts with powder actuated fastener.	100
BR-2.0-PAF	4	2" capacity – mounts with powder actuated fastener.	100
BR-1.5-SN	5	1 1/2" capacity – mounts with screws, nails, or other user supplied fasteners.	100
BR-2.0-SN	5	2" capacity – mounts with screws, nails, or other user supplied fasteners.	100
BR-1.5-TW	6	1 1/2" capacity – mounts with toggle screw.	100
BR-2.0-TW	6	2" capacity – mounts with toggle screw.	100

Cable/Conduit

Beam/Purlin

Hangers/Hanging
Systems

Stud Wall

Communication/
Low Voltage

Dry Wall

Acoustical

Miscellaneous

Sizing Information
Reference

Codes & Standards
Reference

Index

Notes

Dry Wall

Low-Voltage Mounting Brackets



Image 1

- Choose design styles for new or retrofit installations
- Available in both single and double gang configurations
- Manufactured from galvanized steel materials

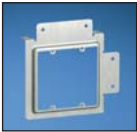

Image 2



Image 3



Image 4

Part Number	Image No.	Description	Std. Pkg. Qty.
LV-S-1G	1	Single gang, low-voltage mounting bracket for new installations.	25
LV-S-2G	2	Double gang, low-voltage mounting bracket for new installations.	25
LV-W-1G	3	Single gang, low-voltage mounting bracket for retrofit installations; suitable for wall material thicknesses for 1/2"– 1 1/2".	100
LV-W-2G	4	Double gang, low-voltage mounting bracket for retrofit installations; suitable for wall material thicknesses for 1/2"– 1 1/2".	50



Old Work Box Mount



- Prevents electrical box from pulling away from dry wall
- Supports box to dry wall to prevent mounting directly to stud
- Allows quick installation with no tools required
- Manufactured from pre-galvanized steel

Part Number	Description	Std. Pkg. Qty.
PDSI2A	Secures electrical box to dry wall.	100

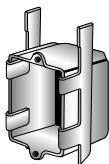

Wiring Device Retainer



- Provides stability and prevents broken cover plates
- Manufactured from pre-galvanized steel

Part Number	Description	Std. Pkg. Qty.
PRLC	Mounts standard outlet or switch in oversized openings.	100

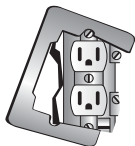

Acoustical

Troffer Fastener Clip



- Positive clip-on support for troffers/lay-in fixtures
- Fits round or rectangular head T-bars
- Complies with NEC Article 410.36 requirements (reference pages K.10 – K.11 for details)
- For upturned or straight lip fixtures



Part Number	Description	Std. Pkg. Qty.
P515A	T-bar clip for troffers.	100

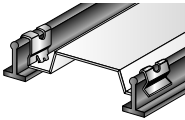

T-Bar Clip



- Supports outlet boxes above acoustical T-bar
- Top-mounted applications
- Used in conjunction with T-bar clip top-mount assemblies to eliminate the need for offset bending conduit
- Meets NEC Article 300.11 requirements (reference page K.2 for details)

Part Number	Description	Std. Pkg. Qty.
PATA4I	T-bar clip with 1/4-20 mounting hole.	100

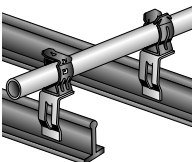

T-Bar Clip Top-Mount Assemblies



Image 1

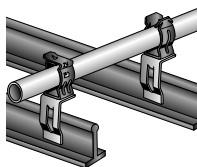

Image 2

- For supporting conduit above acoustical T-bar
- Top-mounted applications
- Used in conjunction with T-bar clips mounted to electrical boxes to eliminate the need for offset bending conduit
- Meet NEC Article 300.11 requirements (reference page K.2 for details)

Part Number	Image No.	Fits EMT (In.)	Fits Rigid/IMC (In.)	Std. Pkg. Qty.
P8PATA	1	1/2	—	100
P12PATA	1	3/4	1/2	100
P16PATA	1	1	3/4	100
P6MATA	2	3/8*	3/8	100
P812MATA	2	1/2 – 3/4	1/2 – 3/4	100
P16MATA	2	1	1	100

*Or 14-2 through 12-3 MC/AC cable.



Order number of pieces required, in multiples of Standard Package Quantity.

T-Bar Clip Side-Mount Assemblies



Image 1

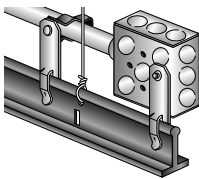

Image 2

- Support conduit above acoustical T-bar in side-mounted applications
- Used in conjunction with T-bar clips mounted to electrical boxes to eliminate the need for offset bending conduit
- Meets NEC Article 300.11 requirements (reference page K.2 for details)

Part Number	Image No.	Fits EMT (In.)	Fits Rigid/IMC (In.)	Std. Pkg. Qty.
P8PATS	1	1/2	—	100
P12PATS	1	3/4	1/2	100
P16PATS	1	1	3/4	100
P6MATS	2	3/8*	3/8	100
P812MATS	2	1/2 – 3/4	1/2 – 3/4	100
P16MATS	2	1	1	100

*Or 14-2 through 12-3 MC/AC cable.



T-Bar Drop Wire Clip



- Provides a means to support fixtures from building structure instead of T-bar
- Includes 5/8" stud and wing nut washer
- Accommodates 1" T-bar
- Manufactured from pre-galvanized materials



Part Number	Description	Static Load Rating (Lbs.)	Std. Pkg. Qty.
PIDS	T-bar drop wire clip for use with 1" T-bar.	65	50

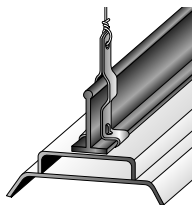

T-Bar Fastener



- Provides method of attaching conduit and electrical boxes above T-bar
- Allows secure screw attachment to T-bar
- Eliminates offset bend in conduit

Part Number	Description	Std. Pkg. Qty.
P4ACS	Conduit and box support for T-bar with 1/4-20 threaded impression.	100

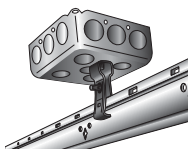

Order number of pieces required, in multiples of Standard Package Quantity.

Box to T-Bar Fasteners

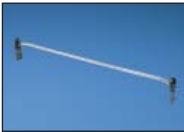

P512



P512A

- Accommodate 24" T-bar span
- Non-adjustable version has fitting suitable for flush or offset mount
- Adjustable version provides for 8" adjustments allowing the installation of double deep boxes, speaker cases, and emergency light fixtures above T-bar

Part Number	Description	Std. Pkg. Qty.
P512*	Box to T-bar fastener for flush or 3/4" offset mount.	50
P512A	Box to T-bar fastener allows up to 8" of height adjustment.	25

*UL and cUL listed.

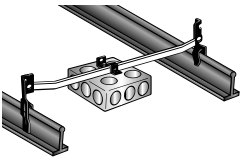

Heavy Duty Adjustable Box Mounting Bar Hangers



P512HDK

- Box fastener adjustable for 16" – 24" ceiling joist/stud spacing
- Allow versatility in installing electrical boxes along the length of the bar
- Install quickly and easily between ceiling joists or wall studs



P512HDT

Part Number	Description	Std. Pkg. Qty.
P512HDK	Installs in 1/2" knockouts in bottom of electrical box.	50
P512HDT	Includes 3/4" stud to accommodate fixture stems.	50



Order number of pieces required, in multiples of Standard Package Quantity.

T-Bar Assembly for Lighting Support



- Accommodates fixed 24" T-bar span
- Allows for adjustable fixture position
- Fits Lightolier 5 and Calculite* series fixtures

Part Number	Description	Std. Pkg. Qty.
P520	T-bar assembly that fits Lightolier 5 and Calculite* series fixtures.	25

*Lightolier and Calculite are trademarks of the Phillips group brand.

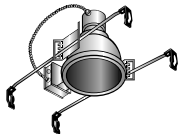

Twist-On T-Bar Hanger



- Easily twists onto T-bar to support electrical fixtures
- Accommodates T-bar 15/16" wide
- Includes 1" wing nut washer (see page H.3)



Part Number	Description	Static Load Rating (Lbs.)	Std. Pkg. Qty.
P4G16	Twist-on T-bar hanger with 1/4-20 x 5/8" long threaded stud.	50	100

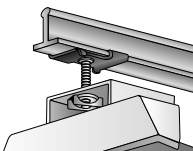

T-Bar Scissor Clips**PPT16**

- Support electrical fixtures or boxes to 1" wide T-bar
- Include 1" wing nut washer (see page H.3)
- Multiple stud lengths provided
- No tools required for installation

**P4G162**

Part Number	Description	Std. Pkg. Qty.
PPT16	T-bar scissor clip with 1/4-20 x 5/8" stud.	50
P4G162	T-bar scissor clip with 1/4-20 x 2" stud.	50

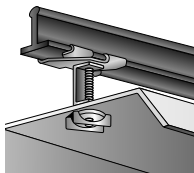

Independent Drop Wire Clips



PEC311



PEC3114Z34

- Prevent sway of dedicated drop wire
- Satisfy NEC Article 300.11 code requirements (reference page K.2 for details); consult local authority
- Yellow color provides easy identification by inspectors

Part Number	Description	Std. Pkg. Qty.
PEC311	Independent drop wire clip.	100
PEC3114Z34	Independent drop wire clip with spring steel drop wire clip.	100

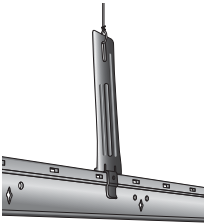

Cable/Conduit

Beam/Purlin

Hangers/Hanging
Systems

Stud Wall

Communication/
Low Voltage

Dry Wall

Acoustical

Miscellaneous

Sizing Information
Reference

Codes & Standards
Reference

Index

Notes

Miscellaneous

Rod Hangers with Threaded Impressions



- Prevent the need for additional nuts
- Include 1/4" mounting hole in top for assemblies
- Static load capacity: 160 lbs.

Part Number	Description	Std. Pkg. Qty.
P4TI	Accommodates 1/4-20 threaded rod.	100
P6TI	Accommodates 3/8-16 threaded rod.	100

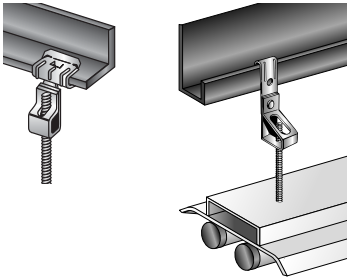

Rod Hanger for Non-Threaded Rod

- Friction fit prevents the need for additional hardware
- Static load capacity: 160 lbs.

Part Number	Description	Std. Pkg. Qty.
P6A	3/8" non-threaded rod.	100

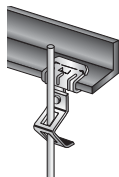
**Offset Bracket**

- Utilized for assemblies or a variety of other applications
- Prevents conduit bends to accommodate electrical boxes
- Static load capacity: 160 lbs.

Part Number	Description	Std. Pkg. Qty.
PAO	Offset bracket with two 1/4" non-threaded holes.	100

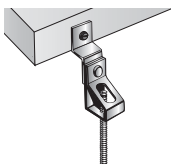

Order number of pieces required, in multiples of Standard Package Quantity.

Wing Nut Washer



- Used in conjunction with products with 1/4-20 stud
- Manufactured from pre-galvanized steel
- Suitable to be installed by hand; no tools required
- Not to exceed load rating of the corresponding fastener

Part Number	Description	Std. Pkg. Qty.
P4WN	Wing nut washer fits 1/4-20 stud.	100

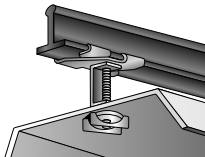

Cable/Conduit

Beam/Purlin

Hangers/Hanging
Systems

Stud Wall

Communication/
Low Voltage

Dry Wall

Acoustical

Miscellaneous

Sizing Information
Reference

Codes & Standards
Reference

Index

Notes

Order number of pieces required, in multiples of Standard Package Quantity.

Convenient Sizing Information

Electrical Metallic Tubing (EMT)

Trade Size (In.)	Nominal Inside Dia.* (In.)	Nominal Outside Dia. (In.)	Min. Weight Per 100 Ft. w/ Couplings Attached (Lbs.)	Weight of Conduit and Conductors Per 100 Ft. (Lbs.)
0.38	0.49	0.58	23.00	36.60
0.50	0.62	0.71	28.50	50.60
0.75	0.82	0.92	43.50	84.30
1.00	1.05	1.16	64.00	130.30
1.25	1.38	1.51	95.00	212.30
1.50	1.61	1.74	110.00	269.80
2.00	2.07	2.20	140.00	401.80
2.50	2.73	2.88	205.00	579.00
3.00	3.36	3.50	250.00	826.30
3.50	3.83	4.00	325.00	1098.00
4.00	4.33	4.50	370.00	1364.00

*Per UL table NAE.3.

Intermediate Metal Conduit (IMC)

Trade Size (In.)	Nominal Inside Dia.* (In.)	Nominal Outside Dia. (In.)	Min. Weight Per 100 Ft. w/ Couplings Attached (Lbs.)	Weight of Conduit and Conductors Per 100 Ft. (Lbs.)
0.50	0.68	0.82	60.00	82.10
0.75	0.88	1.03	82.00	122.80
1.00	1.12	1.29	116.00	182.30
1.25	1.47	1.64	150.00	267.30
1.50	1.70	1.88	182.00	341.80
2.00	2.17	2.36	242.00	503.80
2.50	2.60	2.86	401.00	775.00
3.00	3.22	3.48	493.00	1069.00
3.50	3.71	3.97	573.00	1346.00
4.00	4.21	4.47	638.00	1632.00

*Per UL table NAE.3.

Rigid Steel Conduit

Trade Size (In.)	Nominal Inside Dia.* (In.)	Nominal Outside Dia. (In.)	Min. Weight Per 100 Ft. w/ Couplings Attached (Lbs.)	Weight of Conduit and Conductors Per 100 Ft. (Lbs.)
0.38	0.49	0.68	51.50	65.10
0.50	0.63	0.84	79.00	101.00
0.75	0.84	1.05	105.00	145.80
1.00	1.06	1.32	153.00	219.30
1.25	1.39	1.66	201.00	318.30
1.50	1.62	1.90	249.00	408.80
2.00	2.08	2.38	332.00	593.80
2.50	2.49	2.88	527.00	901.00
3.00	3.09	3.50	682.60	1259.00
3.50	3.57	4.00	831.00	1604.00
4.00	4.05	4.50	972.30	1967.00

*Per UL table NAE.3.

Rigid Aluminum Conduit

Trade Size (In.)	Nominal Inside Dia.* (In.)	Nominal Outside Dia. (In.)	Min. Weight Per 100 Ft. w/ Couplings Attached (Lbs.)	Weight of Conduit and Conductors Per 100 Ft. (Lbs.)
0.50	0.63	0.84	27.40	49.50
0.75	0.84	1.05	36.40	77.20
1.00	1.06	1.32	53.00	119.30
1.25	1.39	1.66	69.60	186.90
1.50	1.62	1.90	82.20	242.00
2.00	2.08	2.38	115.70	377.50
2.50	2.49	2.88	182.50	556.50
3.00	3.09	3.50	238.90	815.20
3.50	3.57	4.00	287.70	1061.00
4.00	4.05	4.50	340.00	1334.00
5.00	5.07	5.56	465.40	2028.00
6.00	6.09	6.63	612.50	2870.00

*Per UL table NAE.3.

Order number of pieces required, in multiples of Standard Package Quantity.

Electrical Non-Metallic Tubing (ENT)

Trade Nominal Size (In.)	Nominal Inside Dia.* (In.)	Nominal Outside Dia. (In.)	Min. Weight of Conduit Per 100 Ft. (Lbs.)	Weight of Conduit and Conductors Per 100 Ft. (Lbs.)
0.50	0.56	0.84	11.00	33.10
0.75	0.76	1.05	14.00	54.80
1.00	1.00	1.32	20.00	86.30
1.25	1.40	1.66	19.00	136.30
1.50	1.55	1.99	27.00	186.80
2.00	2.03	2.38	32.00	261.80

*Per UL table NAE.3.

Schedule 40 PVC Plastic Pipe

Nominal Pipe Size (In.)	Outside Dia. (In.)	Wall Thickness (In.)	Weight of Pipe Per Ft. (Lbs.)	Weight of Water Per Ft. (Lbs.)
0.13	0.41	0.07	0.04	0.02
0.25	0.54	0.09	0.07	0.04
0.38	0.68	0.09	0.10	0.08
0.50	0.84	0.11	0.15	0.1
0.75	1.05	0.11	0.20	0.20
1.00	1.32	0.13	0.30	0.40
1.25	1.66	0.14	0.40	0.60
1.50	1.90	0.15	0.50	0.90
2.00	2.38	0.15	0.60	1.40
2.50	2.88	0.20	1.00	2.10
3.00	3.50	0.22	1.30	3.20
3.50	4.00	0.23	1.60	4.30
4.00	4.50	0.24	1.90	5.50

All Threaded Rod (ATR)

Nominal Size and Thread	Root Area		Design Load SF = 5	
	In. ²	cm ²	Lbs.	kN
1/4-20	0.03	0.17	240.00	1.07
5/16-18	0.05	0.29	400.00	1.78
3/8-16	0.07	0.44	610.00	2.71

MC Cable

AWG Size	Insulated Ground Nominal Outside Dia. (In.)	Bare Ground Nominal Outside Dia. (In.)
14-2 Solid	0.45	0.43
14-3 Solid	0.48	0.44
14-4 Solid	0.51	0.49
12-2 Solid	0.50	0.47
12-3 Solid	0.53	0.50
12-4 Solid	0.57	0.56
10-2 Solid	0.56	0.52
10-3 Solid	0.60	0.55
10-4 Solid	0.65	0.62
8-2 Stranded	0.71	0.68
8-3 Stranded	0.77	0.71
8-4 Stranded	0.84	0.77
6-2 Stranded	0.80	0.76
6-3 Stranded	0.87	0.80
6-4 Stranded	0.95	0.87
4-2 Stranded	0.95	0.90
4-3 Stranded	1.04	0.95
4-4 Stranded	1.14	1.10
2-2 Stranded	1.08	1.00
2-3 Stranded	1.18	1.08
2-4 Stranded	1.30	1.18

AC Cable

Type of Armored Cable	Type of Circuit Conductors	AWG Size of Circuit Conductors	Minimum External Diameter of Armor									
			Cable with Two Circuit Conductors and No Grounding and a Grounding Conductor (in.)		Cable with Three Circuit Conductors and No Grounding and a Grounding Conductor, and Cable with Two Circuit Conductors and a Grounding Conductor (in.)		Cable with Four Circuit Conductors and No Grounding and a Grounding Conductor, and Cable with Three Circuit Conductors and a Grounding Conductor (in.)		Cable with Four Circuit Conductors and a Grounding Conductor (in.)			
			Solid	Stranded	Solid	Stranded	Solid	Stranded	Solid	Stranded	Solid	Stranded
ACTMM	THHN	14	0.43	—	0.45	—	0.49	—	0.52	—	0.52	—
		12	0.48	—	0.49	—	0.52	—	0.55	—	0.55	—
		10	0.48	—	0.50	—	0.54	—	0.59	—	0.59	—
		8	0.57	0.60	0.60	0.64	0.65	0.70	0.71	0.76	0.71	0.76
		6	—	0.70	—	0.74	—	0.81	—	0.88	—	0.88
		4	—	0.84	—	0.89	—	0.97	—	1.07	—	1.07
		2	—	0.96	—	1.01	—	1.12	—	1.23	—	

Type NM – Non-Metallic Sheathed Cable

AWG Size	No. of Strands	Ground Wire Size	Approximate Outside Dia. (In.)	Approximate Weight Per 100 Ft. (Lbs.)
----------	----------------	------------------	--------------------------------	---------------------------------------

Without Ground Wire

14-2	Solid	—	0.17 x 0.37	5.30
12-2	Solid	—	0.19 x 0.40	7.00
10-2	Solid	—	0.22 x 0.45	10.10
14-3	Solid	—	0.30	8.20
12-3	Solid	—	0.33	10.90
10-3	Solid	—	0.40	15.70
8-3	7	—	0.54	27.80
6-3	7	—	0.61	42.20

With Ground Wire

14-2	Solid	14	0.17 x 0.37	6.40
12-2	Solid	12	0.19 x 0.41	9.00
10-2	Solid	10	0.22 x 0.49	13.30
8-2	7	10	0.28 x 0.61	21.50
6-2	7	10	0.32 x 0.73	31.30
14-3	Solid	14	0.32	9.30
12-3	Solid	12	0.36	12.90
10-3	Solid	10	0.44	18.70
14-4	Solid	14	0.45	11.60
12-4	Solid	12	0.49	16.10
10-4	Solid	10	0.55	23.30
8-3	7	10	0.55	30.50
6-3	7	10	0.61	45.00
4-3	7	8	0.82	66.40
2-3	7	8	0.95	93.00

Order number of pieces required, in multiples of Standard Package Quantity.

Type THHN – Insulated Single Conductor Building Wire

Size (AWG)	Armor Outside Dia. (In.)	Approximate Weight Per 100 Ft. (Lbs.)
14	0.11	1.70
12	0.13	2.50
10	0.16	4.00
8	0.22	6.50
6	0.25	9.70
4	0.32	15.50
3	0.35	19.10
2	0.38	23.60
1	0.45	30.40
1/0	0.49	37.50

Cable/Conduit

Beam/Purlin

Hangers/Hanging Systems

Stud Wall

Communication/ Low Voltage

Dry Wall

Acoustical

Miscellaneous

Sizing Information Reference

Codes & Standards Reference

Index

Communication Cable

Cable Type	Diameter (In.)
Category 6A	0.300
Category 6A (SD)	0.240
Category 6	0.240
Category 5e	0.225

J-Pro™ Capacity

J-Pro™ Family	Category 6A (0.300")	Category 6A (SD) (0.240")	Category 6 (0.240")	Category 5e (0.225")
JP75	5	8	8	10
JP131	15	25	25	29
JP2	30	46	46	55
JP4	115	180	180	200

Note: The above cable diameters represent the nominal Panduit cable diameter per performance level. For specific cable fill information based on specific part numbers, please contact customer service.

Codes and Standards

NFPA 70; National Electric Code; 2011 Revision

90.4 Enforcement. This Code is intended to be suitable for mandatory application by governmental bodies that exercise legal jurisdiction over electrical installations, including signaling and communications systems, and for use by insurance inspectors. The authority having jurisdiction for enforcement of the Code has the responsibility for making interpretations of the rules, for deciding on the approval of equipment and materials, and for granting the special permission contemplated in a number of the rules.

By special permission, the authority having jurisdiction may waive specific requirements in this Code or permit alternative methods where it is assured that equivalent objectives can be achieved by establishing and maintaining effective safety.

This Code may require new products, constructions, or materials that may not yet be available at the time the Code is adopted. In such event, the authority having jurisdiction may permit the use of the products, constructions, or materials that comply with the most recent previous edition of this Code adopted by the jurisdiction.

300.4 Protection Against Physical Damage.

(B) Nonmetallic-Sheathed Cables and Electrical Nonmetallic Tubing through Metal Framing Members.

(1) Nonmetallic-Sheathed Cable. In both exposed and concealed locations where nonmetallic-sheathed cables pass through either factory- or field-punched, cut, or drilled slots or holes in metal members, the cable shall be protected by listed bushings or listed grommets covering all metal edges that are securely fastened in the opening prior to installation of the cable.

(D) Cables and Raceways Parallel to Framing Members and Furring Strips.

In both exposed and concealed locations, where a cable- or raceway-type wiring method is installed parallel to framing members, such as joists, rafters, or studs, or is installed parallel to furring strips, the cable or raceway shall be installed and supported so that the nearest outside surface of the cable or raceway is not less than 32mm (1 1/4 in.) from the nearest edge of the framing member or furring strips where nails or screws are likely to penetrate. Where this distance cannot be maintained, the cable or raceway shall be protected from penetration by nails or screws by a steel plate, sleeve, or equivalent at least 1.6mm (1/16 in.) thick.

Exception No. 1: *Steel plates, sleeves, or the equivalent shall not be required to protect rigid metal conduit, intermediate metal conduit, rigid nonmetallic conduit, or electrical metallic tubing.*

Exception No. 2: *For concealed work in finished buildings, or finished panels for prefabricated buildings where such supporting is impracticable, it shall be permissible to fish the cables between access points.*

Exception No. 3: *A listed and marked steel plate less than 1.6mm (1/16 in.) thick that provides equal or better protection*

PANDUIT®

NFPA 70; National Electric Code; 2011 Revision (continued)

against nail or screw penetration shall be permitted.

300.11 Securing and Supporting.

(A) Secured in Place. Raceways, cable assemblies, boxes, cabinets, and fittings shall be securely fastened in place. Support wires that do not provide secure support shall not be permitted as the sole support. Support wires and associated fittings that provide secure support and that are installed in addition to the ceiling grid support wires shall be permitted as the sole support. Where independent support wires are used, they shall be secured at both ends. Cables and raceways shall not be supported by ceiling grids.

(1) Fire-Rated Assemblies. Wiring located within the cavity of a fire-rated floor-ceiling or roof-ceiling assembly shall not be secured to, or supported by, the ceiling assembly, including the ceiling support wires. An independent means of secure support shall be provided and shall be permitted to be attached to the assembly. Where independent support wires are used, they shall be distinguishable by color, tagging, or other effective means from those that are part of the fire-rated design.

Exception: The ceiling support system shall be permitted to support wiring and equipment that have been tested as part of the fire-rated assembly.

Informational Note: One method of determining fire rating is testing in accordance with NFPA 251-2006, *Standard Methods of Tests of Fire Resistance of Building Construction and Materials*.

(2) Non-Fire-Rated Assemblies. Wiring located within the cavity of a non-fire-rated floor-ceiling or roof-ceiling assembly shall not be secured to, or supported by, the ceiling assembly, including the ceiling support wires. An independent means of secure support shall be provided and shall be permitted to be attached to the assembly. Where independent support wires are used, they shall be distinguishable by color, tagging, or other effective means.

Exception: The ceiling support system shall be permitted to support branch-circuit wiring and associated equipment where installed in accordance with the ceiling system manufacturer's instructions.

300.22 Wiring in Ducts not used for Air Handling, Fabricated Ducts for Environmental Air, and other Spaces for Environmental Air (Plenums). The provisions of this section shall apply to the installation and uses of electrical wiring and equipment in ducts used for dust, loose stock, or vapor removal; ducts specifically fabricated for environmental air; and other spaces used for environmental air (plenums).

Informational Note: See Article 424, Part VI, for duct heaters.

(A) Ducts for Dust, Loose Stock, or Vapor Removal. No wiring systems of any type shall be installed in ducts used to transport dust, loose stock, or flammable vapors. No wiring system of any

Order number of pieces required, in multiples of Standard Package Quantity.

NFPA 70; National Electric Code; 2011 Revision (continued)

type shall be installed in any duct, or shaft containing only such ducts, used for vapor removal or for ventilation of commercial-type cooking equipment.

(B) Ducts Specifically Fabricated for Environmental Air.

Only wiring methods consisting of Type MI cable, Type MC cable employing a smooth or corrugated impervious metal sheath without an overall nonmetallic covering, electrical metallic tubing, flexible metallic tubing, intermediate metal conduit, or rigid metal conduit without an overall nonmetallic covering shall be installed in ducts specifically fabricated to transport environmental air. Flexible metal conduit shall be permitted, in lengths not to exceed 1.2m (4 ft.), to connect physically adjustable equipment and devices permitted to be in these fabricated ducts. The connectors used with flexible metal conduit shall effectively close any openings in the connection. Equipment and devices shall be permitted within such ducts only if necessary for the direct action upon, or sensing of, the contained air. Where equipment or devices are installed and illumination is necessary to facilitate maintenance and repair, enclosed gasketed-type luminaires shall be permitted.

(C) Other Spaces Used for Environmental Air (Plenums).

This section shall apply to spaces not specifically fabricated for environmental air-handling purposes but used for air-handling purposes as a plenum. This section shall not apply to habitable rooms or areas of buildings, the prime purpose of which is not air handling.

Informational Note No. 1: The space over a hung ceiling used for environmental air-handling purposes is an example of the type of other space to which this section applies.

Informational Note No. 2: The phrase "Other Spaces Used for Environmental Air (Plenum)" as used in this section correlates with the use of the term "plenum" in NFPA 90A-2009, *Standard for the Installation of Air-Conditioning and Ventilating Systems*, and other mechanical codes where the plenum is used for return air purposes, as well as some other air-handling spaces.

Exception: This section shall not apply to the joist or stud spaces of dwelling units where the wiring passes through such spaces perpendicular to the long dimension of such spaces.

(1) Wiring Methods. The wiring methods for such other space shall be limited to totally enclosed, nonventilated, insulated busway having no provisions for plug-in connections, Type MI cable, Type MC cable without an overall nonmetallic covering, Type AC cable, or other factory-assembled multiconductor control or power cable that is specifically listed for use within an air-handling space, or listed prefabricated cable assemblies of metallic manufactured wiring systems without nonmetallic sheath. Other types of cables, conductors, and raceways shall be permitted to be installed in electrical metallic tubing, flexible metallic tubing, intermediate metal conduit, rigid metal conduit without an overall nonmetallic covering, flexible metal conduit, or, where accessible, surface metal raceway or metal wireway

NFPA 70; National Electric Code; 2011 Revision (continued)

with metal covers.

2) Cable Tray Systems. The provisions in (a) or (b) shall apply to the use of metallic cable tray systems in other spaces used for environmental air (plenums), where accessible, as follows:

(a) *Metal Cable Tray Systems.* Metal cable tray systems shall be permitted to support the wiring methods in 300.22 (C)(1).

(b) *Solid Side and Bottom Metal Cable Tray Systems.*

Solid side and bottom metal cable tray systems with solid metal covers shall be permitted to enclose wiring methods and cables, not already covered in 300.22 (C)(1), in accordance with 392.10 (A) and (B).

(3) Equipment. Electrical equipment with a metal enclosure, or electrical equipment with a nonmetallic enclosure listed for use within an air-handling space and having adequate fire-resistant and low-smoke-producing characteristics, and associated wiring material suitable for the ambient temperature shall be permitted to be installed in such other space unless prohibited elsewhere in this Code.

Informational Note: One method of defining adequate fire-resistant and low-smoke producing characteristics for electrical equipment with a nonmetallic enclosure is in ANSI/UL 2043-2008, *Fire Test for Heat and Visible Smoke Release for Discrete Products and Their Accessories Installed in Air-Handling Spaces.*

Exception: Integral fan systems shall be permitted where specifically identified for use within an air-handling space.

(D) Information Technology Equipment. Electrical wiring in air-handling areas beneath raised floors for information technology equipment shall be permitted in accordance with Article 645.

310.15 Ampacities for Conductors Rated 0–2000 Volts.

(B) Tables...

(3) Adjustment Factors.

(a) *More Than Three Current-Carrying Conductors in a Raceway or Cable.* Where the number of current-carrying conductors in a raceway or cable exceeds three, or where single conductors or multiconductor cables are installed without maintaining spacing for a continuous length longer than 600mm (24 in.) and are not installed in raceways, the allowable ampacity of each conductor shall be reduced as shown in Table 310.15 (B)(3)(a). Each current-carrying conductor of a paralleled set of conductors shall be counted as a current-carrying conductor.

Where conductors of different systems, as provided in 300.3, are installed in a common raceway or cable, the adjustment factors shown in Table 310.15 (B)(3)(a) shall apply only to the number of power and lighting conductors (Articles 210, 215, 220, and 230). Informational Note No. 1: See Annex B, Table B.310.15 (B)(2)(11), for adjustment factors for more than three current-carrying conductors in a raceway or cable with load diversity.

Informational Note No. 2: See 366.23 (A) for adjustment factors for conductors in sheet metal auxiliary gutters and 376.22 (B) for

Order number of pieces required, in multiples of Standard Package Quantity.

NFPA 70; National Electric Code; 2011 Revision (continued)

adjustment factors for conductors in metal wireways.

(4) Adjustment factors shall not apply to Type AC cable or to Type MC cable under the following conditions:

- a. The cables do not have an overall outer jacket.
- b. Each cable has not more than three current-carrying conductors.
- c. The conductors are 12 AWG copper.
- d. Not more than 20 current-carrying conductors are installed without maintaining spacing, are stacked, or are supported on “bridle rings.”

(5) An adjustment factor of 60 percent shall be applied to Type AC cable or Type MC cable under the following conditions:

- a. The cables do not have an overall outer jacket.
- b. The number of current carrying conductors exceeds 20.
- c. The cables are stacked or bundled longer than 600mm (24 in.) without spacing being maintained.

314.23 Supports. Enclosures within the scope of this article shall be supported in accordance with one or more of the provisions in 314.23 (A) through (H).

(C) Mounting in Finished Surfaces. An enclosure mounted in a finished surface shall be rigidly secured thereto by clamps, anchors, or fittings identified for the application.

(D) Suspended Ceilings. An enclosure mounted to structural or supporting elements of a suspended ceiling shall be not more than 1650cm³ (100 in.³) in size and shall be securely fastened in place in accordance with either (D)(1) or (D)(2).

(1) Framing Members. An enclosure shall be fastened to the framing members by mechanical means such as bolts, screws, or rivets, or by the use of clips or other securing means identified for use with the type of ceiling framing member(s) and enclosure(s) employed. The framing members shall be adequately supported and securely fastened to each other and to the building structure.

2) Support Wires. The installation shall comply with the provisions of 300.11 (A). The enclosure shall be secured, using methods identified for the purpose, to ceiling support wire(s), including any additional support wire(s) installed for that purpose. Support wire(s) used for enclosure support shall be fastened at each end so as to be taut within the ceiling cavity.

(E) Raceway Supported Enclosure, without Devices, Luminaires, or Lampholders. An enclosure that does not contain a device(s) other than splicing devices or support a luminaire(s), lampholder, or other equipment and is supported by entering raceways shall not exceed 1650cm³ (100 in.³) in size. It shall have threaded entries or have hubs identified for the purpose. It shall be supported by two or more conduits threaded wrenchtight into the enclosure or hubs. Each conduit shall be secured within 900mm (3 ft.) of the enclosure, or within 450mm (18 in.) of the enclosure if all conduit entries are on the same side.

Exception: The following wiring methods shall be permitted to support a conduit body of any size, including a conduit body constructed with only one conduit entry, if the trade size of the

NFPA 70; National Electric Code; 2011 Revision (continued)

conduit body is not larger than the largest trade size of the conduit or tubing:

- (1) Intermediate metal conduit, Type IMC
- (2) Rigid metal conduit, Type RMC
- (3) Rigid polyvinyl chloride conduit, Type PVC
- (4) Reinforced thermosetting resin conduit, Type RTRC
- (5) Electrical metallic tubing, Type EMT

(F) Raceway-Supported Enclosures, with Devices, Luminaires, or Lampholders. An enclosure that contains a device(s), other than splicing devices, or supports a luminaire(s), lampholder, or other equipment and is supported by entering raceways shall not exceed 1650cm³ (100 in.³) in size. It shall have threaded entries or have hubs identified for the purpose. It shall be supported by two or more conduits threaded wrenchtight into the enclosure or hubs. Each conduit shall be secured within 450mm (18 in.) of the enclosure.
Exception No. 1: Rigid metal or intermediate metal conduit shall be permitted to support a conduit body of any size, including a conduit body constructed with only one conduit entry, provided the trade size of the conduit body is not larger than the largest trade size of the conduit.

Exception No. 2: An unbroken length(s) of rigid or intermediate metal conduit shall be permitted to support a box used for luminaire or lampholder support, or to support a wiring enclosure that is an integral part of a luminaire and used in lieu of a box in accordance with 300.15 (B), where all of the following conditions are met:

- (a) The conduit is securely fastened at a point so that the length of conduit beyond the last point of conduit support does not exceed 900mm (3 ft.).
- (b) The unbroken conduit length before the last point of conduit support is 300mm (12 in.) or greater, and that portion of the conduit is securely fastened at some point not less than 300mm (12 in.) from its last point of support.
- (c) Where accessible to unqualified persons, the luminaire or lampholder, measured to its lowest point, is at least 2.5m (8 ft.) above grade or standing area and at least 900mm (3 ft.) measured horizontally to the 2.5m (8 ft.) elevation from windows, doors, porches, fire escapes, or similar locations.
- (d) A luminaire supported by a single conduit does not exceed 300mm (12 in.) in any direction from the point of conduit entry.
- (e) The weight supported by any single conduit does not exceed 9 kg (20 lbs.).
- (f) At the luminaire or lampholder end, the conduit(s) is threaded wrenchtight into the box, conduit body, or integral wiring enclosure, or into hubs identified for the purpose. Where a box or conduit body is used for support, the luminaire shall be secured directly to the box or conduit body, or through a threaded conduit nipple not over 75mm (3 in.) long.

314.27 Outlet Boxes.

(A) Boxes at Luminaire or Lampholder Outlets. Outlet boxes or

Order number of pieces required, in multiples of Standard Package Quantity.

NFPA 70; National Electric Code; 2011 Revision (continued)

fittings designed for the support of luminaires and lampholders, and installed as required by 314.23, shall be permitted to support a luminaire or lampholder.

(2) Ceiling Outlets. At every outlet used exclusively for lighting, the box shall be designed or installed so that a luminaire or lampholder may be attached. Boxes shall be required to support a luminaire weighing a minimum of 23 kg (50 lbs.). A luminaire that weighs more than 23 kg (50 lbs.) shall be supported independently of the outlet box, unless the outlet box is listed and marked for the maximum weight to be supported.

320.2 Definition.

Armored Cable, Type AC.

A fabricated assembly of insulated conductors in a flexible interlocked metallic armor. See 320.100.

320.17 Through or Parallel to Framing Members. Type AC cable shall be protected in accordance with 300.4 (A), (C), and (D) where installed through or parallel to framing members.

320.30 Securing and Supporting.

(A) General. Type AC cable shall be supported and secured by staples, cable ties, straps, hangers, or similar fittings, designed and installed so as not to damage the cable.

(B) Securing. Unless otherwise permitted, Type AC cable shall be secured within 300mm (12 in.) of every outlet box, junction box, cabinet, or fitting and at intervals not exceeding 1.4m (4 1/2 ft.) where installed on or across framing members.

(C) Supporting. Unless otherwise permitted, Type AC cable shall be supported at intervals not exceeding 1.4m (4 1/2 ft.).

Horizontal runs of Type AC cable installed in wooden or metal framing members or similar supporting means shall be considered supported where such support does not exceed 1.4m (4 1/2 ft.) intervals.

330.2 Definition.

Metal Clad Cable, Type MC. A factory assembly of one or more insulated circuit conductors with or without optical fiber members enclosed in an armor of interlocking metal tape, or a smooth or corrugated metallic sheath.

330.17 Through or Parallel to Framing Members.

Type MC cable shall be protected in accordance with 300.4 (A), (C), and (D) where installed through or parallel to framing members.

330.30 Securing and Supporting.

(A) General. Type MC cable shall be supported and secured by staples, cable ties, straps, hangers, or similar fittings or other approved means designed and installed so as not to damage the cable.

(B) Securing. Unless otherwise provided, cables shall be secured

NFPA 70; National Electric Code; 2011 Revision (continued)

at intervals not exceeding 1.8m (6 ft.). Cables containing four or fewer conductors sized no larger than 10 AWG shall be secured within 300mm (12 in.) of every box, cabinet, fitting, or other cable termination.

(C) Supporting. Unless otherwise provided, cables shall be supported at intervals not exceeding 1.8m (6 ft.). Horizontal runs of Type MC cable installed in wooden or metal framing members or similar supporting means shall be considered supported and secured where such support does not exceed 1.8m (6 ft.) intervals.

334.2 Definitions.

Nonmetallic-Sheathed Cable. A factory assembly of two or more insulated conductors enclosed within an overall nonmetallic jacket.

334.17 Through or Parallel to Framing Members.

Types NM, NMC, or NMS cable shall be protected in accordance with 300.4 where installed through or parallel to framing members. Grommets used as required in 300.4 (B)(1) shall remain in place and be listed for the purpose of cable protection.

334.30 Securing and Supporting.

Nonmetallic-sheathed cable shall be supported and secured by staples, cable ties, straps, hangers, or similar fittings designed and installed so as not to damage the cable, at intervals not exceeding 1.4m (4 1/2 ft.) and within 300mm (12 in.) of every outlet box, junction box, cabinet, or fitting. Flat cables shall not be stapled on edge.

Sections of cable protected from physical damage by raceway shall not be required to be secured within the raceway.

(A) Horizontal Runs Through Holes and Notches.

In other than vertical runs, cables installed in accordance with 300.4 shall be considered to be supported and secured where such support does not exceed 1.4m (4 1/2 ft.) intervals and the nonmetallic-sheathed cable is securely fastened in place by an approved means within 300mm (12 in.) of each box, cabinet, conduit body, or other nonmetallic-sheathed cable termination.

Informational Note: See 314.17 (C) for support where nonmetallic boxes are used.

342.30 Securing and Supporting.

IMC shall be installed as a complete system in accordance with 300.18 and shall be securely fastened in place and supported in accordance with 342.30 (A) and (B).

(A) Securely Fastened. IMC shall be secured in accordance with one of the following:

(1) IMC shall be securely fastened within 900mm (3 ft.) of each outlet box, junction box, device box, cabinet, conduit body, or other conduit termination.

(2) Where structural members do not readily permit fastening within 900mm (3 ft.), fastening shall be permitted to be increased

NFPA 70; National Electric Code; 2011 Revision (continued)

to a distance of 1.5m (5 ft.).

(3) Where approved, conduit shall not be required to be securely fastened within 900mm (3 ft.) of the service head for above-the-roof termination of a mast.

(B) Supports. IMC shall be supported in accordance with one of the following:

(1) Conduit shall be supported at intervals not exceeding 3m (10 ft.).

(2) The distance between supports for straight runs of conduit shall be permitted in accordance with Table 344.30 (B)(2), provided the conduit is made up with threaded couplings and such supports prevent transmission of stresses to termination where conduit is deflected between supports.

344.30 Securing and Supporting. RMC shall be installed as a complete system in accordance with 300.18 and shall be securely fastened in place and supported in accordance with 344.30 (A) and (B).

(A) Securely Fastened. RMC shall be securely fastened within 900mm (3 ft.) of each outlet box, junction box, device box, cabinet, conduit body, or other conduit termination. Fastening shall be permitted to be increased to a distance of 1.5m (5 ft.) where structural members do not readily permit fastening within 900mm (3 ft.). Where approved, conduit shall not be required to be securely fastened within 900mm (3 ft.) of the service head for above-the-roof termination of a mast.

(B) Supports. RMC shall be supported in accordance with one of the following:

(1) Conduit shall be supported at intervals not exceeding 3m (10 ft.).

(2) The distance between supports for straight runs of conduit shall be permitted in accordance with Table 344.30 (B)(2), provided the conduit is made up with threaded couplings and such supports prevent transmission of stresses to termination where conduit is deflected between supports.

348.30 Securing and Supporting. FMC shall be securely fastened in place and supported in accordance with 348.30 (A) and (B).

(A) Securely Fastened. FMC shall be securely fastened in place by an approved means within 300mm (12 in.) of each box, cabinet, conduit body, or other conduit termination and shall be supported and secured at intervals not to exceed 1.4m (4 1/2 ft.).

(B) Supports. Horizontal runs of FMC supported by openings through framing members at intervals not greater than 1.4m (4 1/2 ft.) and securely fastened within 300mm (12 in.) of termination points shall be permitted.

358.30 Securing and Supporting. EMT shall be installed as a complete system in accordance with 300.18 and shall be

NFPA 70; National Electric Code; 2011 Revision (continued)

securely fastened in place and supported in accordance with 358.30 (A) and (B).

(A) Securely Fastened. EMT shall be securely fastened in place at least every 3m (10 ft.). In addition, each EMT run between termination points shall be securely fastened within 900mm (3 ft.) of each outlet box, junction box, device box, cabinet, conduit body, or other tubing termination.

Exception No. 1: Fastening of unbroken lengths shall be permitted to be increased to a distance of 1.5m (5 ft.) where structural members do not readily permit fastening within 900mm (3 ft.).

Exception No. 2: For concealed work in finished buildings or prefinished wall panels where such securing is impracticable, unbroken lengths (without coupling) of EMT shall be permitted to be fished.

(B) Supports. Horizontal runs of EMT supported by openings through framing members at intervals not greater than 3m (10 ft.) and securely fastened within 900mm (3 ft.) of termination points shall be permitted.

362.2 Definition.

Electrical Nonmetallic Tubing (ENT). A nonmetallic, pliable, corrugated raceway of circular cross section with integral or associated couplings, connectors, and fittings for the installation of electrical conductors. ENT is composed of a material that is resistant to moisture and chemical atmospheres and is flame retardant.

A pliable raceway is a raceway that can be bent by hand with a reasonable force but without other assistance.

362.30 Securing and Supporting. ENT shall be installed as a complete system in accordance with 300.18 and shall be securely fastened in place and supported in accordance with 362.30 (A) and (B).

(A) Securely Fastened. ENT shall be securely fastened at intervals not exceeding 900mm (3 ft.). In addition, ENT shall be securely fastened in place within 900mm (3 ft.) of each outlet box, device box, junction box, cabinet, or fitting where it terminates.

Exception No. 1: Lengths not exceeding a distance of 1.8m (6 ft.) from a luminaire terminal connection for tap connections to lighting luminaires shall be permitted without being secured.

Exception No. 2: Lengths not exceeding 1.8m (6 ft.) from the last point where the raceway is securely fastened for connections within an accessible ceiling to luminaire(s) or other equipment.

Exception No. 3: For concealed work in finished buildings or prefinished wall panels where such securing is impracticable, unbroken lengths (without coupling) of ENT shall be permitted to be fished.

410.36 Means of Support.

(A) Outlet Boxes. Outlet boxes or fittings installed as required by 314.23 and complying with the provisions of 314.27 (A)(1) and 314.27

Order number of pieces required, in multiples of Standard Package Quantity.

NFPA 70; National Electric Code; 2011 Revision (continued)

(A)(2) shall be permitted to support luminaires.

(B) Suspended Ceilings. Framing members of suspended ceiling systems used to support luminaires shall be securely fastened to each other and shall be securely attached to the building structure at appropriate intervals. Luminaires shall be securely fastened to the ceiling framing member by mechanical means such as bolts, screws, or rivets. Listed clips identified for use with the type of ceiling framing member(s) and luminaire(s) shall also be permitted.

410.154 Fastening. Lighting track shall be securely mounted so that each fastening is suitable for supporting the maximum weight of luminaires that can be installed. Unless identified for supports at greater intervals, a single section 1.2m (4 ft.) or shorter in length shall have two supports, and, where installed in a continuous row, each individual section of not more than 1.2m (4 ft.) in length shall have one additional support.

590.4 General.

(J) Support. Cable assemblies and flexible cords and cables shall be supported in place at intervals that ensure that they will be protected from physical damage. Support shall be in the form of staples, cable ties, straps, or similar type fittings installed so as not to cause damage. Vegetation shall not be used for support of overhead spans of branch circuits or feeders.

Exception: For holiday lighting in accordance with 590.3 (B), where the conductors or cables are arranged with strain relief devices, tension take-up devices, or other approved means to avoid damage from the movement of the live vegetation, trees shall be permitted to be used for support of overhead spans of branch-circuit conductors or cables.

604.7 Installation. Manufactured wiring systems shall be secured and supported in accordance with the applicable cable or conduit article for the cable or conduit type employed.

725.24 Mechanical Execution of Work. Class 1, Class 2, and Class 3 circuits shall be installed in a neat and workmanlike manner. Cables and conductors installed exposed on the surface of ceilings and sidewalls shall be supported by the building structure in such a manner that the cable will not be damaged by normal building use. Such cables shall be supported by straps, staples, hangers, cable ties, or similar fittings designed and installed so as not to damage the cable. The installation shall also comply with 300.4 (D).

760.24 Mechanical Execution of Work. Fire alarm circuits shall be installed in a neat workmanlike manner. Cables and conductors installed exposed on the surface of ceilings and sidewalls shall be supported by the building structure in such a manner that the cable will not be damaged by normal building use. Such cables

NFPA 70; National Electric Code; 2011 Revision (continued)

shall be supported by straps, staples, cable ties, hangers, or similar fittings designed and installed so as not to damage the cable. The installation shall also comply with 300.4 (D).

800.24 Mechanical Execution of Work.

Communications circuits and equipment shall be installed in a neat and workmanlike manner. Cables installed exposed on the surface of ceilings and sidewalls shall be supported by the building structure in such a manner that the cable will not be damaged by normal building use. Such cables shall be secured by hardware, including straps, staples, cable ties, hangers, or similar fittings designed and installed so as not to damage the cable. The installation shall also conform to 300.4 (D) and 300.11.

Informational Note No. 1: Accepted industry practices are described in ANSI/NECA/BICSI 568-2006, *Standard for Installing Commercial Building Telecommunications Cabling*; ANSI/TIA/EIA-568-B.1-2004 — Part 1, General Requirements Commercial Building Telecommunications Cabling Standard; ANSI/TIA-569-B-2004, *Commercial Building Standard for Telecommunications Pathways and Spaces*; ANSI/TIA-570-B, *Residential Telecommunications Infrastructure*, and other ANSI-approved installation standards.

Informational Note No. 2: See NFPA 90A-2009, *Standard for Installation of Air-Conditioning and Ventilating Systems*, for discrete combustible components installed in accordance with 300.22 (B) and (C).

Telecommunications Pathways and Spaces; ANSI/TIA-569-C; Revision May, 2012

6.7.6 Low-Voltage Mounting Bracket

A low-voltage mounting bracket is similar to a plaster ring and may be used in place of an outlet box where permitted by code.

9.3.2 Telecommunications Pathway Separation From Lighting

Balanced twisted-pair cabling should be separated from fluorescent lamps and associated fixtures by a minimum of 125mm (5 in.).

9.4.2.1 Planning

The design shall provide a suitable means and method for supporting cables. Cable shall not be laid directly on the ceiling tile or rails.

9.4.2.2 Clearance

A minimum of 75mm (3 in.) clear vertical space shall be available above the ceiling tiles for the cabling and pathway.

9.5.4.3 Cable Management

Providing physical management for cabling placed within the access floor system lessens the chance of damage or reduced performance over the cable's life cycle. A method of physical management for major runs of cabling shall be provided. Management systems such as raceways, cable tray, and non-continuous cable supports may be used.

9.7 Non-Continuous Support

Non-continuous supports shall be located at intervals not to exceed 1.5m (5 ft.). Non-continuous supports shall be selected to accommodate the immediate and anticipated quantity, weight, and performance requirements of cables.

Steel, masonry, independent rods, independent support wires or other structural parts of the building shall be used for cable support attachment points up to the total weight for which the fastener is approved. Rods or wires that are currently employed for other functions (e.g., suspended ceiling grid support) shall not be utilized as attachment points for non-continuous supports.

NOTE: A weight of 1 kg (2.2 lbs.) (or 0.7 kg/m [0.5 lb./ft.] with spacing of support wire/rod at 1.5m [5 ft.]) is equivalent to a bundle of sixteen 4-pair 24 AWG UTP cables, including fasteners.

9.8.3.1 Conduit Termination

Conduits shall be reamed to eliminate sharp edges. Metallic conduit shall be terminated with an insulated bushing.

BICSI TDMM, 12th Edition; 2009 Revision

Page 5-1: Introduction

Horizontal pathways include:

- Continuous pathways (e.g., conduit cable tray and cable matting) used for containment of telecommunications cabling
- Non-continuous pathways (e.g., the space between open-top cable supports [J-hooks]) through which cable is placed between physical support or containment components

Pages 5-39-5-41: Pathway and Cable Support

Every ceiling distribution system must provide proper support for cables from the telecommunications space to the work areas served. Ceiling panels, support channels (T-bars), and suspended ceiling support wires are not proper cabling supports.

Ceiling conduits, raceways, cable trays, and cabling must be suspended from or attached to the structural ceiling or walls with hardware or other installation aids specifically designed to support their weight.

The pathways must:

- Have adequate support to withstand cable pulling
- Be installed with at least 75mm (3 in.) of clear vertical space above the ceiling tiles and support channels (T-bars) to ensure accessibility

Horizontal pathways or cable should not rest directly on or be supported by:

- Ceiling panels
- Support channels (T-bars)
- Ceiling support wires
- Other components of the suspended ceiling

It is important to provide sufficient space between the suspended ceiling structure and the telecommunications pathways/cables to install, maneuver, and store ceiling tiles during service. When sufficient space is available above the pathway, up to 150mm (6 in.) should be provided between the suspended ceiling and the cabling pathways.

Where building codes permit telecommunications cable to be placed in suspended ceiling spaces without conduit, ceiling zone distribution pathways may consist of:

- Cable trays
- Open-top supports (e.g., J-hooks)

NOTE: J-hooks should be located 1.5m (5 ft.) apart at the maximum to adequately support and distribute the cable's weight. The manufacturer's specifications for cable loading should be followed.

BICSI TDMM, 12th Edition; 2009 Revision (continued)

Cable support devices that have narrow surface areas to support the cable laying horizontally inside or on top may have a detrimental effect on the transmissions performance of higher performance cabling systems.

If possible, a wider surface area should be chosen to support the cable as a precaution against potential problems. Another precaution would be to reduce the distance between the support devices.

Suspended cables must be installed with at least 75mm (3 in.) of clear vertical space above the ceiling tiles and support channels (T-bars).

For large quantities of cables (50 or more) that converge at the ER, TR, and other areas, provide cable trays or other special supports that are specifically designed to support the required cable weight and volume.

Page 5-57: Telecommunications Outlets/Connectors

Telecommunications outlet/connector boxes must be used in fire-rated wall installations and must be firestopped appropriately. Low-voltage mounting brackets (e.g., also known as mud ring, plaster ring, square-drawn cover, and box eliminator) may be used where the wall is not fire rated, and are typically used for work associated with MACs.

Telecommunications outlet/connector boxes installed in dry wall, plaster, or concrete block wall are available in an array of shapes and sizes. The size of each telecommunications outlet/connector box must be of a size that is adequate to accommodate the type and density of cabling to be installed.

Telecommunications outlet/connector boxes should not be placed back to back to serve adjacent rooms. This can compromise the effectiveness of the wall as a sound barrier and as a firestop.

**J-Pro™ Cable Support System –
Frequently Asked Questions****Question:****What references define how and where J-hooks are used?****Answer:**

J-hooks are a horizontal pathway promoted in the BICSI® TDM manual as a means to route cable bundles (see catalog pages K.14 – K.15). Furthermore, the TIA-569-C standard promotes non-continuous supports as a means to route cable bundles as well (see catalog page K.13). According to Underwriters Laboratories Inc. (UL), the portion of the NEC® that defines the requirements of this cabling pathway is found in Section 300.22 of the NEC (see catalog pages K.2 – K.4).

Question:**What is the difference between plenum space and air handling space?****Answer:**

The industry-wide confusion regarding the definition of a *plenum space* versus an *air handling space* is very common as the area above a drop ceiling is mistakenly referred to as a plenum.

Simply stated, the NEC defines a plenum area as, “a compartment or chamber to which one or more air ducts are connected and that forms part of the air distribution system.” They also reference, “the space over a hung ceiling used for environmental air-handling purposes,” and, “areas beneath raised floors for information technology equipment,” as air handling space (NEC pg. 70-144 and 70-145; see catalog pages K.2 – K.4). Often, the NEC definition of these terms differs from their common use in the industry – however, UL is compatible with the NEC terms and definitions. Therefore, the space above a hung (or drop/suspended) ceiling utilized as an air return to the HVAC unit is considered an air handling space. Additionally, the area below a raised floor used to supply conditioned air is also considered an air handling space.

Question:**Is the J-Pro™ Cable Support System approved by UL for use in air handling spaces in the United States?****Answer:**

Yes, during the development of the J-Pro™ Cable Support System, Panduit coordinated testing and evaluation with UL for approval of the following statement on all the J-Pro™ Cable Support System products to reduce confusion in the market: “Suitable for use in air handling spaces in accordance with Section 300.22 (C) and (D) of the NEC....” This statement is engraved and is visible on the side or bottom of each part. According to this phrase, the J-Pro™ Cable

Order number of pieces required, in multiples of Standard Package Quantity.

J-Pro™ Cable Support System – Frequently Asked Questions (continued)

Support System can be utilized in the area above the suspended ceiling (300.22 [C]) or below a raised floor (300.22 [D]), but it cannot be utilized within ductwork (300.22 [A] and [B]) (see catalog pages K.2 – K.4). Approval to use J-Pro™ Cable Support System above the suspended ceiling and below the raised floor was a result of completing/passing testing of the J-Pro™ Cable Support System per the UL standard UL2043, Fire Test for Visible Heat and Smoke Release for Discrete Products and their Accessories Installed in Air-Handling Spaces. This test requires product to meet certain criteria for heat release and smoke density and the values measured correlate back to the maximum flame spread and smoke index of the mechanical code. The basic standard used to investigate products in this category is ANSI/UL 1565, “Positioning Devices”. The J-Pro™ Cable Support System product line is UL listed within UL file number E136577.

Question:

Is the J-Pro™ Cable Support System approved by Underwriters’ Laboratories of Canada (ULC) for use in air handling spaces?

Answer:

Yes, for applications within Canada, the J-Pro™ Cable Support System was tested and evaluated by ULC for approval of the following statement, “In accordance with CAN/ULC S102.2 in single units or pairs. 4-foot minimum spacing, FSR = 0, SDC = 35.” This statement is engraved and visible on the side or bottom of each part. According to this phrase, the J-Pro™ Cable Support System is approved for the same air handling spaces as defined by the NEC Article 300.22 (C) and (D) (above the suspended ceiling or below a raised floor) and meets the S102.2 (Standard Method of Test for Surface Burning Characteristics of Floor Coverings, and Miscellaneous Material and Assemblies) requirements as stated in the National Building Code of Canada. The J-Pro™ Cable Support System product line is ULC listed within ULC file number R21673.

UL
File E136577
Volume 2, Section 2
Page 1

ULC
File R21673
Volume 1

Description

Product Covered:
 USL, CNL – Positioning Devices – Model JP2, JP4, JP75, JP131

General Description:
 USL, CNL – Indicates that the products have been evaluated in accordance with the requirements in UL 1565 and CAN/CSA C22.2 No. 18.5-02 Standards for Positioning Devices.

These devices are a J-Pro™ J-hook, and are used in applications where zone conduit, cable trays, or ladder racks are not available or applicable.

The J-Pro™ J-hook contains a family of parts. This system has several other brackets and/or components, manufactured from a high-carbon plated steel, riveted to the JP2, JP4, JP75, and JP131 for a variety of applications.

Table 1

Family of Part Numbers	J-Pro™ Cable Support System Description
JP2	J-Pro™ J-hook

Ratings:

These devices are rated 60°C, for indoor use, suitable for use in air handling spaces in accordance with Sec. 300.22 (C) and (D) of the National Electrical Code in single units or pairs, and 30 lb. maximum load rating.

Table 3

Family of Part Numbers	J-Pro™ Cable Support System Description
JP4	J-Pro™ J-hook

Ratings:

These devices are rated 60°C, for indoor use, suitable for use in air handling spaces in accordance with Sec. 300.22 (C) and (D) of the National Electrical Code, and 100 lb. maximum load rating in single unit configuration only.

Order number of pieces required, in multiples of Standard Package Quantity.

Table 4

Family of Part Numbers	J-Pro™ Cable Support System Description
JP75	J-Pro™ J-hook

Ratings:

These devices are rated 60°C, for indoor use, suitable for use in air handling spaces in accordance with Sec. 300.22 (C) and (D) of the National Electrical Code in single units or pairs, and 15 lb. maximum load rating.

Table 5

Family of Part Numbers	J-Pro™ Cable Support System Description
JP131	J-Pro™ J-hook

Ratings:

These devices are rated 60°C, for indoor use, suitable for use in air handling spaces in accordance with Sec. 300.22 (C) and (D) of the National Electrical Code in single units or pairs, and 20 lb. maximum load rating.

Scope for UL 1565 Positioning Devices
1 Scope

1:1 This standard applies to those metallic and nonmetallic devices used for positioning – which may include bundling and securing – or to a limited extent supporting cable, wire, conduit, or tubing of a wiring system in electrical installations, to reduce the risk of fire, electric shock, or injury to persons. This standard applies to, but is not limited to, cable ties, cable tie mounting blocks, cable clamps, cable and conduit clips, and non-raceway ducts.

Standard Method of Test for Surface Burning Characteristics of Floor Coverings, and Miscellaneous Material and Assemblies, CAN/ULC-S102.2-M88.

On April 1, 2004, fire tests were conducted at our ULC Toronto facilities in accordance with the Standard CAN/ULC-S102.2-03, Standard Method of Test for Surface Burning Characteristics of Floor Covering, and Miscellaneous Materials and Assemblies.



LISTED
Plastic
Materials
15KH

Listed in accordance with CAN/ULC-S102.2

Flame	Smoke
<u>Spread</u>	<u>Developed</u>
0	35

15KH = The control number assigned by ULC.

0 = The Flame Spread rating assigned by ULC.

35 = The Smoke Developed value assigned by ULC.

The J-Pro™ (JP2 and JP2W) products may be marked with the Flame Spread and Smoke Developed values as shown above when mounted as single units or pairs with a minimum spacing of 1220mm.

These parts may be fastened to metal clips to product the following part number (with the same mounting requirements above), which may also bear the ULC mark:

JP2HBC25RB-	JP75DW-	JP75SBC87-	JP131CP-
JP4HBC50RB-	JP2HBC50RB-	JP75SBC50-	JP75SBC87RB-
JP131UF100-	JP4HBC75RB-	JP2HBC75RB-	JP75SBC50RB-
JP131CMB-	JP131WP2B-	JP4ZP-	JP2HBC25RB-
JP2ZP-	JP75HBC25RB-	JP131DW-	JP131SBC87-
JP4CP-	JP2HBC50RB-	JP2CP-	JP75HBC50RB-
JP131SBC50-	JP131SBC87RB-	JP4UF100-	JP2HBC75RB-
JP2UF100-	JP75HBC75RB-	JP131SBC50RB-	JP4W-
JP4WP2B-	JP2CMB-	JP2WP2B-	JP75ZP-
JP131HBC25RB-	JP4CMB-	JP4SBC87-	JP2DW-
JP2SBC87-	JP75CP-	JP131HBC50RB-	JP4SBC50-
JP4SBC87RB-	JP2SBC50-	JP2SBC87RB-	JP75UF100-
JP131HBC75RB-	JP4SBC50RB-	JP2SBC50RB-	JP75CMB-
JP75WP2B-	JP131ZP-	JP4HBC25RB-	

Order number of pieces required, in multiples of Standard Package Quantity.

Part Number Index

Part Number	Page Number	Part Number	Page Number
B			
BR-1.5-PAF	E.13	JP2SBC50RB-L20	E.4
BR-1.5-SN	E.13	JP2SBC87-L20	E.4
BR-1.5-TW	E.13	JP2SBC87RB-L20	E.4
BR-1.25	E.13	JP2UF100-L20	E.4
BR-1.25-1/4-20	E.13	JP2W-L20	E.4
BR-1.25-10-24	E.13	JP2WP2B-L20	E.4
BR-1.25-14WS	E.13	JP2ZP-L20	E.4
BR-2.0	E.13	JP4CMB-X20	E.5
BR-2.0-1/4-20	E.13	JP4CP-X20	E.5
BR-2.0-10-24	E.13	JP4HBC25RB-X20	E.5
BR-2.0-14WS	E.13	JP4HBC50RB-X20	E.5
BR-2.0-PAF	E.13	JP4HBC75RB-X20	E.5
BR-2.0-SN	E.13	JP4SBC50RB-X20	E.5
BR-2.0-TW	E.13	JP4SBC50-X20	E.5
BR-4.0-1/4-20	E.13	JP4SBC87RB-X20	E.5
BR-.50	E.13	JP4SBC87-X20	E.5
BR-.50-10-24	E.13	JP4UF100-X20	E.5
BR-.75	E.13	JP4WP2B-X20	E.5
BR-.75-10-24	E.13	JP4W-X20	E.5
C			
CSM-1.25-C	D.18	JP4ZP-X20	E.5
H			
HLSP1.5S-X0	E.10	JP75CMB-L20	E.2
HLSP1.5S-X12	E.10	JP75CP-L20	E.2
HLSP3S-X0	E.10	JP75DW-L20	E.2
HLSP3S-X12	E.10	JP75HBC25RB-L20	E.2
HLSP5S-X0	E.10	JP75HBC50RB-L20	E.2
HLSP5S-X12	E.10	JP75HBC75RB-L20	E.2
HLTP2I-X0	E.10	JP75SBC50-L20	E.2
HLTP2I-X12	E.10	JP75SBC50RB-L20	E.2
HLTP3I-X0	E.10	JP75SBC87-L20	E.2
HLTP3I-X12	E.10	JP75SBC87RB-L20	E.2
HLTT1.5S-C20	E.11	JP75UF100-L20	E.2
HLTT1.5S-Q20	E.11	JP75W-L20	E.2
J			
JMCB-X	E.9	JP75WP2B-L20	E.2
JMCMB25-1-X	E.9	JP75ZP-L20	E.2
JMCMB25-3-X	E.9	JP131CMB-L20	E.3
JMDWB-1-X	E.9	JP131CP-L20	E.3
JMDWB-3-X	E.9	JP131DW-L20	E.3
JMJH2W-X20	E.9	JP131HBC25RBL20	E.3
JMJH2-X20	E.9	JP131HBC50RBL20	E.3
JMSBCB87-1-X	E.9	JP131HBC75RBL20	E.3
JMSBCB87-3-X	E.9	JP131SBC50-L20	E.3
JMTRB38-1-X	E.9	JP131SBC50RBL20	E.3
JMTRB38-3-X	E.9	JP131SBC87-L20	E.3
JP2CMB-L20	E.4	JP131SBC87RBL20	E.3
JP2CP-L20	E.4	JP131SBC87RBL20	E.3
JP2DW-L20	E.4	JP131UF100-L20	E.3
JP2HBC25RB-L20	E.4	JP131W-L20	E.3
JP2HBC50RB-L20	E.4	JP131WP2B-L20	E.3
JP2HBC75RB-L20	E.4	JP131ZP-L20	E.3
JP2SBC50-L20	E.4	L	
M			
		LV-S-1G	F.1
		LV-S-2G	F.1
		LV-W-1G	F.1
		LV-W-2G	F.1
		MSG-1.3-C	D.17
		MSGV-1.3-C	D.17

Cable/Conduit
Beam/Purlin
Hangers/Hanging Systems
Stud Wall
Communication/Low Voltage
Dry Wall
Acoustical
Miscellaneous
Sizing Information Reference
Codes & Standards Reference
Index

Part Number	Page Number	Part Number	Page Number
MSPT-1.3	D.18	P32M	A.1
P			
P122	B.8	P32M24	A.3
P123	B.8	P32M24SM	A.4
P1224TI	B.11	P32M58	A.3
P1226T	B.11	P32M58SM	A.4
P1226TI	B.11	P32M912	A.3
P1236M	B.10	P32M912SM	A.4
P1238P	B.10	P449	A.15
P12312P	B.10	P4ACS	G.4
P12316M	B.10	P4G16	G.7
P12316P	B.10	P4G162	G.8
P12320M	B.10	P4H24	B.2
P123812M	B.10	P4H58	B.2
P12P	A.2	P4H912	B.2
P12P12P	A.9	P4TI	H.1
P12P16P	A.9	P4TI24	B.6
P12P24	A.5	P4TI58	B.6
P12P24SM	A.5	P4TI912	B.6
P12P58	A.5	P4TIB	C.1
P12P58SM	A.5	P4TIO	C.1
P12P912	A.5	P4WN	H.3
P12P912SM	A.5	P4Z34	A.8
P166M	A.9	P4Z348P	A.8
P1616M	A.9	P4Z3412P	A.8
P1620M	A.9	P4Z3416M	A.8
P1624M	A.9	P4Z3416P	A.8
P16812M	A.9	P4Z34812M	A.8
P16M	A.1	P6A	H.2
P16M24	A.3	P6A24	B.6
P16M24SM	A.4	P6A58	B.6
P16M58	A.3	P6A912	B.6
P16M58SM	A.4	P6AO	C.1
P16M912	A.3	P6M	A.1
P16M912SM	A.4	P6M24	A.3
P16MB18	A.13	P6M24SM	A.4
P16MB18A	A.13	P6M58	A.3
P16P	A.2	P6M58SM	A.4
P16P16P	A.9	P6M912	A.3
P16P24	A.5	P6M912SM	A.4
P16P24SM	A.5	P6MATA	G.2
P16P58	A.5	P6MATS	G.3
P16P58SM	A.5	P6MB18	A.12
P16P912	A.5	P6MB18A	A.12
P16P912SM	A.5	P6MF	D.5
P20M	A.1	P6TA24	B.6
P20M24	A.3	P6TA58	B.6
P20M24SM	A.4	P6TB	C.1
P20M58	A.3	P6TI	H.1
P20M58SM	A.4	P6TI24	B.6
P20M912	A.3	P6TI58	B.6
P20M912SM	A.4	P6TI912	B.6
P24M	A.1	P6TIB	C.1
P24M24	A.3	P6TIO	C.1
P24M24SM	A.4	P6TO	C.1
P24M58	A.3	P6Z34	A.8
P24M58SM	A.4	P812M	A.1
P24M912	A.3	P812M4I	A.1
P24M912SM	A.4	P812M24	A.3
		P812M24SM	A.4
		P812M58	A.3

Order number of pieces required, in multiples of Standard Package Quantity.

Part Number	Page Number	Part Number	Page Number
P812M58SM	A.4	PBC16P	B.4
P812M912	A.3	PBC16PSM	B.4
P812M912SM	A.4	PBC20M	B.4
P812MB18	A.12	PBC20MSM	B.4
P812MB18A	A.12	PBC24M	B.4
P812MB18S	A.13	PBC24MSM	B.4
P812MB1824	A.12	PBC32M	B.4
P8P	A.2	PBC32MSM	B.4
P8P8P	A.9	PBC200	B.1
P8P12P	A.9	PBC200CD1B	B.5
P8P16P	A.9	PBC200CD2.5B	B.5
P8P24	A.5	PBC200CD2B	B.5
P8P24SM	A.5	PBC200CD3B	B.5
P8P58	A.5	PBC200CD4B	B.5
P8P58SM	A.5	PBC200CD5B	B.5
P8P912	A.5	PBC400	B.1
P8P912SM	A.5	PBC812M	B.4
P8PATA	G.2	PBC812MSM	B.4
P8PATS	G.3	PCATHBA	E.6
P8PF	D.5	PCD0B	A.2
P12PATA	G.2	PCD1B	A.2
P12PATS	G.3	PCD2.5B	A.2
P12PF	D.5	PCD2B	A.2
P16MATA	G.2	PCD3B	A.2
P16MATS	G.3	PCD4B	A.2
P16MF	D.5	PCD5B	A.2
P16PATA	G.2	PCD6B	A.2
P16PATS	G.3	PCD7B	A.2
P16PF	D.5	PCD8B	A.2
P304B2	D.2	PCD9B	A.2
P350	D.6	PCJ6	D.14
P512	G.5	PCNB8P	A.17
P512A	G.5	PCNB12P	A.17
P512HDK	G.6	PCNB812M	A.17
P512HDT	G.6	PCS16	D.2
P515A	G.1	PCS812D	D.2
P520	G.7	PCS812	D.2
P766	D.8	PDSI2A	F.2
P766PMD	D.8	PEC311	G.9
P812MATA	G.2	PEC3114Z34	G.9
P812MATS	G.3	PFB6M	D.16
P812MF	D.5	PFB8P	D.16
P3508P	D.7	PFB12P	D.16
P35012P	D.7	PFB812M	D.16
P35016M	D.7	PFBS18	D.12
P35016P	D.7	PFMBS18	D.13
P350812M	D.7	PFXC20	D.15
PAF14	B.7	PH4	D.1
PAO	H.2	PH6	D.1
PAOL8P	A.18	PH23	D.1
PAOL12P	A.18	PIDS	G.4
PAOL16P	A.18	PJ1A4	D.8
PATA4I	G.1	PJ1A6	D.8
PBC	B.1	PJ1A25	D.8
PBC8P	B.4	PJ1A35	D.8
PBC8PSM	B.4	PK8	A.6, A.7
PBC12P	B.4	PK12	A.7
PBC12PSM	B.4	PK16	A.7
PBC16M	B.4	PK20	A.7
PBC16MSM	B.4	PKX	A.6

Part Number	Page Number	Part Number	Page Number
PM24	B.3	PSCH72B	A.10
PM24S	B.3	PSGB16A	D.11
PM58	B.3	PSGB24A	D.11
PM58S	B.3	PSK85I	A.11
PM912	B.3	PSK125I	A.11
PM912S	B.3	PSK165I	A.11
PMCS50	A.16	PSK205I	A.11
PMCS100	A.16	PSK245I	A.11
PMCS101	A.16	PSK325I	A.11
PMEB1	D.1	PSK405I	A.11
PMF250	D.4	PSK485I	A.11
PMF375	D.4	PSK565I	A.11
PMF500	D.4	PSK645I	A.11
PMF625	D.4	PTSGB16	D.9
PMF750	D.4	PTSGB24	D.9
PMFO	D.3	PVF14	B.7
PMFS	D.3	PVF144TI	B.9
PMSF	D.3	PVF146T	B.9
PMSR24	C.2	PVF146TI	B.9
PMSR58	C.2	PWMX3	A.15
PMSR912	C.2	PWMX6	A.15
PMSS24	C.2		
PMSS58	C.2		
PMSS912	C.2		
PPT16	G.8		
PRBS16	D.10		
PRBS24	D.10		
PRLC	F.2		
PSC2A	A.14		
PSC2B	A.14		
PSC2C	A.14		
PSC2D	A.14		
PSC2E	A.14		
PSC2F	A.14		
PSC2G	A.14		
PSC4A	A.14		
PSC4B	A.14		
PSC4C	A.14		
PSC4D	A.14		
PSC4E	A.14		
PSC4F	A.14		
PSC4G	A.14		
PSC8A	A.14		
PSC8B	A.14		
PSC8C	A.14		
PSC8D	A.14		
PSC8E	A.14		
PSC8F	A.14		
PSC8G	A.14		
PSCH6B	A.10		
PSCH8B	A.10		
PSCH12B	A.10		
PSCH16B	A.10		
PSCH20B	A.10		
PSCH24B	A.10		
PSCH32B	A.10		
PSCH40B	A.10		
PSCH48B	A.10		
PSCH56B	A.10		
PSCH64B	A.10		

T

TTS-20R0	E.11
TTS-35R3-0	E.11
TTS-35RX0	E.11

Order number of pieces required, in multiples of Standard Package Quantity.

Panduit is a global leader in cabling and communication products, delivering end-to-end solutions in support of demanding electrical and networking requirements.

Panduit Catalogs

Electrical Solutions

SA-ELCB10



- **Bundle**
 - Cable Ties
 - Cable Accessories
 - Stainless Steel Cable Ties and Accessories
- **Route/Protect**
 - Wiring Duct
 - Surface Raceway
 - Abrasion Protection
 - Cable Management
- **Terminate**
 - Terminals
 - Power Connectors
 - Grounding Connectors
- **Identification and Safety Solutions**
 - Labeling Systems
 - Labels
 - Pre-Printed and Write-On Markers
 - Permanent Identification
 - Lockout/Tagout and Safety Solutions

Network Connectivity

SA-NCCB51



- Copper Systems
- Fiber Optic Systems
- Power over Ethernet
- Zone Cabling
- Wireless
- Outlets
- Media Distribution
- Physical Infrastructure Management
- Overhead and Underfloor Routing
- Surface Raceway
- Cabinets, Racks, and Cable Management
- Grounding and Bonding
- Industrial
- Labeling and Identification
- Cable Management Accessories

PANDUIT®



Panduit Corporate World Headquarters

Tinley Park, Illinois 60487

For more information

Visit us at www.panduit.com

Contact Customer Service by email: cs@panduit.com

or by phone: 800-777-3300



(1P)WACB24--SA-ENG

© 2014 Panduit Corp.
ALL RIGHTS RESERVED
Printed in the U.S.A.
Catalog Number **WACB24--SA-ENG**
3/2014

Компания «Океан Электроники» предлагает заключение долгосрочных отношений при поставках импортных электронных компонентов на взаимовыгодных условиях!

Наши преимущества:

- Поставка оригинальных импортных электронных компонентов напрямую с производств Америки, Европы и Азии, а так же с крупнейших складов мира;
- Широкая линейка поставок активных и пассивных импортных электронных компонентов (более 30 млн. наименований);
- Поставка сложных, дефицитных, либо снятых с производства позиций;
- Оперативные сроки поставки под заказ (от 5 рабочих дней);
- Экспресс доставка в любую точку России;
- Помощь Конструкторского Отдела и консультации квалифицированных инженеров;
- Техническая поддержка проекта, помощь в подборе аналогов, поставка прототипов;
- Поставка электронных компонентов под контролем ВП;
- Система менеджмента качества сертифицирована по Международному стандарту ISO 9001;
- При необходимости вся продукция военного и аэрокосмического назначения проходит испытания и сертификацию в лаборатории (по согласованию с заказчиком);
- Поставка специализированных компонентов военного и аэрокосмического уровня качества (Xilinx, Altera, Analog Devices, Intersil, Interpoint, Microsemi, Actel, Aeroflex, Peregrine, VPT, Syfer, Eurofarad, Texas Instruments, MS Kennedy, Miteq, Cobham, E2V, MA-COM, Hittite, Mini-Circuits, General Dynamics и др.);

Компания «Океан Электроники» является официальным дистрибьютором и эксклюзивным представителем в России одного из крупнейших производителей разъемов военного и аэрокосмического назначения «JONHON», а так же официальным дистрибьютором и эксклюзивным представителем в России производителя высокотехнологичных и надежных решений для передачи СВЧ сигналов «FORSTAR».



JONHON

«JONHON» (основан в 1970 г.)

Разъемы специального, военного и аэрокосмического назначения:

(Применяются в военной, авиационной, аэрокосмической, морской, железнодорожной, горно- и нефтедобывающей отраслях промышленности)

«FORSTAR» (основан в 1998 г.)

ВЧ соединители, коаксиальные кабели,
кабельные сборки и микроволновые компоненты:

(Применяются в телекоммуникациях гражданского и специального назначения, в средствах связи, РЛС, а так же военной, авиационной и аэрокосмической отраслях промышленности).



Телефон: 8 (812) 309-75-97 (многоканальный)

Факс: 8 (812) 320-03-32

Электронная почта: ocean@oceanchips.ru

Web: <http://oceanchips.ru/>

Адрес: 198099, г. Санкт-Петербург, ул. Калинина, д. 2, корп. 4, лит. А