

DATA SHEET

SKY66294-11: 2000 to 2300 MHz High-Efficiency 4 W Power Amplifier

Applications

- FDD and TDD 2G/3G/4G LTE systems
- 3GPP band 1, 4, 10, and 23 small-cell base stations
- Driver amplifier for micro-base and macro-base stations
- Active antenna array and massive MIMO

Features

- High-efficiency: PAE = 37.3% @ +28 dBm
- High linearity: +28 dBm with -50 dBc ACLR with pre-distortion (20 MHz LTE, 8.5 dB PAR signal)
- High gain: 35.5 dB
- Excellent input and output return loss: to 50 Ω system
- Integrated active bias: performance compensated over temp
- Integrated enable On/Off function: PAEN = 1.7 to 2.5 V
- Single supply voltage: 5.0 V
- Pin-to-pin compatible PA family supporting all 3GPP bands
- Compact (16-pin, 5 x 5 x 1.3 mm) package (MSL3, 260 °C per JEDEC J-STD-020)



Skyworks Green™ products are compliant with all applicable legislation and are halogen-free. For additional information, refer to *Skyworks Definition of Green™*, document number SQ04-0074.

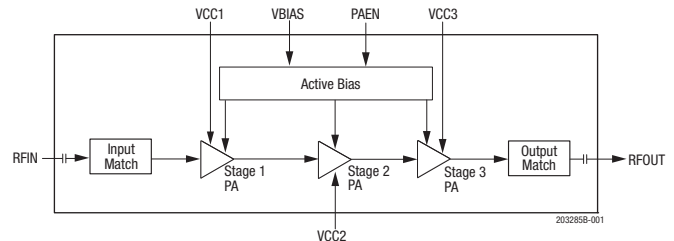

Figure 1. SKY66294-11 Block Diagram

Description

SKY66294-11 is a high-efficiency fully input/output matched power amplifier (PA) with high gain and linearity. The compact 5 x 5 mm PA is designed for FDD and TDD 2G/3G/4G LTE small cell base stations operating from 2000 to 2300 MHz. The active biasing circuitry is integrated to compensate PA performance over temperature, voltage, and process variation.

The SKY66294-11 is part of high-efficiency, pin-to-pin compatible PA family supporting all 3GPP bands.

A block diagram of the SKY66294-11 is shown in Figure 1. Table 1 lists the pin-to-pin compatible parts in the PA family. The device package and pinout are shown in Figure 2. Signal pin assignments and functional pin descriptions are described in Table 2.

Table 1. Pin-to-Pin Compatible PA Family

| Part Number | Frequency (MHz) | 3GPP Band |
|-------------|-----------------|----------------------------------|
| SKY66296-11 | 700 to 800 | Bands 12, 13, 14, 17, 29, and 44 |
| SKY66289-11 | 791 to 821 | Band 20 |
| SKY66295-11 | 800 to 900 | Bands 5, 18, 19, 26 and 27 |
| SKY66298-11 | 900 to 990 | Band 8 |
| SKY66291-11 | 1805 to 1880 | Bands 3 and 9 |
| SKY66299-11 | 1900 to 2000 | Bands 2, 25, 33, 36, and 37 |
| SKY66294-11 | 2000 to 2300 | Bands 1, 4, 10, and 23 |
| SKY66292-11 | 2300 to 2400 | Bands 30, 40 |
| SKY66297-11 | 2490 to 2690 | Bands 7, 38, and 41 |
| SKY66293-21 | 3400 to 3800 | CBRS, Bands 22, 42, 43, and 48 |
| SKY66288-11 | 5150 to 5925 | Band 46 |

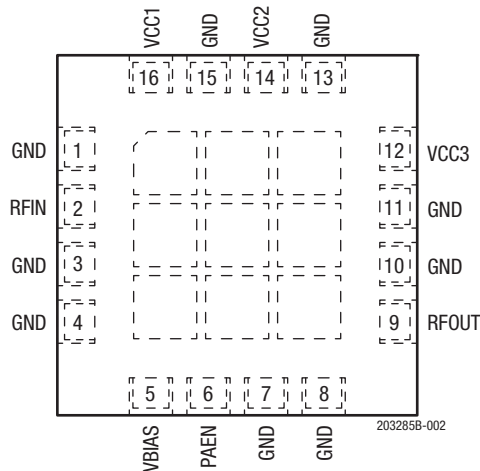

Figure 2. SKY66294-11 Pinout (Top View)

Table 2. SKY66294-11 Signal Descriptions¹

| Pin | Name | Description | Pin | Name | Description |
|-----|-------|---------------|-----|-------|---------------------------|
| 1 | GND | Ground | 9 | RFOUT | RF output port |
| 2 | RFIN | RF input port | 10 | GND | Ground |
| 3 | GND | Ground | 11 | GND | Ground |
| 4 | GND | Ground | 12 | VCC3 | Stage 3 collector voltage |
| 5 | VBIAS | Bias voltage | 13 | GND | Ground |
| 6 | PAEN | PA enable | 14 | VCC2 | Stage 2 collector voltage |
| 7 | GND | Ground | 15 | GND | Ground |
| 8 | GND | Ground | 16 | VCC1 | Stage 1 collector voltage |

¹ The center ground pad must have a low inductance and low thermal resistance connection to the application's printed circuit board ground plane.

Technical Description

The matching circuits are contained within the device. An on-chip active bias circuit is included within the device for both input and output stages, which provides excellent gain tracking over temperature and voltage variations.

The SKY66294-11 is internally matched for maximum output power and efficiency. The input and output stages are independently supplied using the VCC1, VCC2, and VCC3 supply lines (pins 16, 14, and 12, respectively). The DC control voltage that sets the bias is supplied by the VCBIAS signal (pin 5).

Electrical and Mechanical Specifications

The absolute maximum ratings of the SKY66294-11 are provided in Table 3. Recommended operating conditions are specified in Table 4 and electrical specifications are provided in Table 5.

Typical performance characteristics are shown in Figures 3 through 19.

Table 3. SKY66294-11 Absolute Maximum Ratings¹

| Parameter | Symbol | Minimum | Maximum | Units |
|--|-----------------|---------|---------|-------|
| RF input power (CW) | P _{IN} | | +10 | dBm |
| Supply voltage (VCC1, VCC2, VCC3, VBIAS) | V _{CC} | | 5.5 | V |
| PA enable | V _{EN} | | 3 | V |
| Operating temperature | T _C | -40 | +100 | °C |
| Storage temperature | T _{ST} | -55 | +125 | °C |
| Junction temperature | T _J | | +150 | °C |
| Power dissipation | P _D | | 1.4 | W |
| Device thermal resistance | θ _{JC} | | 16.7 | °C/W |
| Electrostatic discharge: | ESD | | | |
| Charged Device Model (CDM) | | | 500 | V |
| Human Body Model (HBM) | | | 1000 | V |

¹ Exposure to maximum rating conditions for extended periods may reduce device reliability. There is no damage to device with only one parameter set at the limit and all other parameters set at or below their nominal value. Exceeding any of the limits listed here may result in permanent damage to the device.

ESD HANDLING: *Although this device is designed to be as robust as possible, electrostatic discharge (ESD) can damage this device. This device must be protected at all times from ESD when handling or transporting. Static charges may easily produce potentials of several kilovolts on the human body or equipment, which can discharge without detection. Industry-standard ESD handling precautions should be used at all times.*

Table 4. SKY66294-11 Recommended Operating Conditions

| Parameter | Symbol | Minimum | Typical | Maximum | Units |
|--|--|---------|---------|---------|-------|
| Supply voltage (VCC1, VCC2, VCC3, VBIAS) | V _{CC1} , V _{CC2} , V _{CC3} , V _{BIAS} | 4.75 | 5 | 5.25 | V |
| PA enable: | PAEN | | | | |
| ON | | 1.7 | 2.0 | 2.5 | V |
| OFF | | | 0 | 0.5 | V |
| PA enable current | I _{ENABLE} | | 1 | 12 | μA |
| Operating frequency | f | 2000 | | 2300 | MHz |
| Operating temperature | T _C | -40 | +25 | +85 | °C |

Table 5. SKY66294-11 Electrical Specifications¹

(Vcc1 = Vcc2 = Vcc3 = VBIAS = 5 V, PAEN = 2.0 V, f = 2140 MHz, Tc = +25 °C, Input/Output Load = 50 Ω, Unless Otherwise Noted)

| Parameter | Symbol | Test Condition | Min | Typical | Max | Units |
|--------------------------------------|----------------|---|-------|---------|-------|-------|
| Frequency | f | | 2110 | | 2170 | MHz |
| Small signal gain | IS21I | PIN = -30 dBm | 34.5 | 36 | | dB |
| Gain @ +28 dBm | IS21I@ +28 dBm | POUT = +28 dBm | 34 | 35.5 | | dB |
| Input return loss | IS11I | PIN = -20 dBm | 12 | 18 | | dB |
| Output return loss | IS22I | PIN = -20 dBm | 12 | 17.5 | | dB |
| Reverse isolation (Note 2) | IS12I | PIN = -30 dBm | | 54 | | dB |
| ACLR @ +28 dBm | ACLR | POUT = +28dBm (20 MHz LTE, 8.5 dB PAR signal) | | -34 | -31.5 | dBc |
| Saturated output power | PSAT | CW, PIN = 8 dBm | +35.7 | +36.3 | | dBm |
| Output power at 3dB gain compression | P3dB | CW, reference to small signal gain | +35 | +36 | | dBm |
| 2 nd harmonic | 2fo | CW, POUT = +28 dBm | | -47 | -41 | dBc |
| 3 rd harmonic | 3fo | CW, POUT = +28 dBm | | -65 | -59 | dBc |
| Power added efficiency | PAE | CW, POUT = +28 dBm | 34 | 36.6 | | % |
| Quiescent current | ICCQ | No RF signal | | 75 | 95 | mA |

¹ Performance is guaranteed only under the conditions listed in this table.

² Not tested in production. Verified by design.

Typical Performance Characteristics

(Vcc1 = Vcc2 = Vcc3 = VBIAS = 5 V, PAEN = 2.0 V, f = 2140 MHz, Tc = +25 °C, Unless Otherwise Noted)

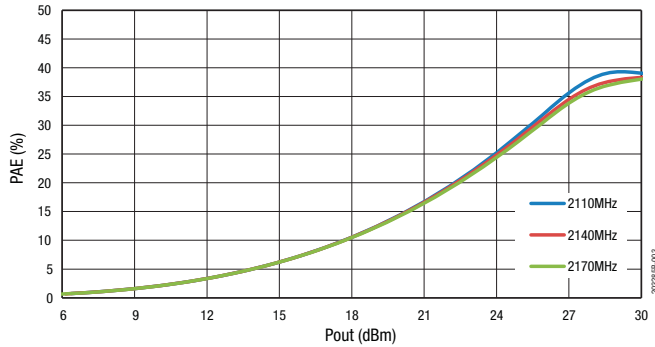

Figure 3. PAE vs Pout Across Frequency

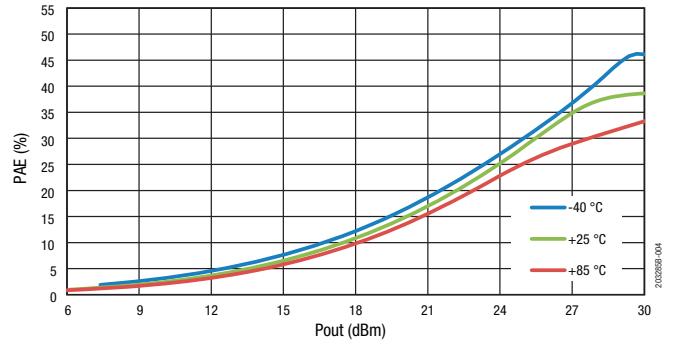

Figure 4. PAE vs Pout Across Temperature

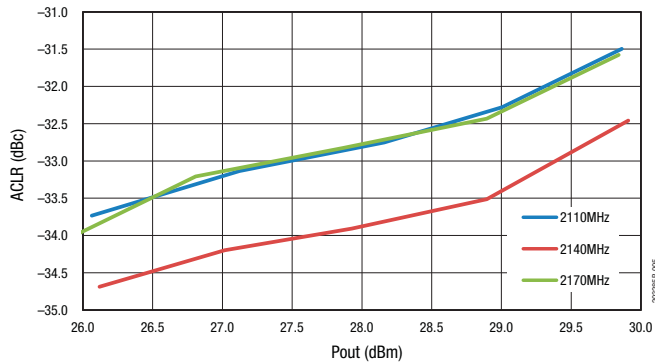

Figure 5. ACLR vs Pout Across Frequency (20 MHz LTE, 8.5 dB PAR Signal)

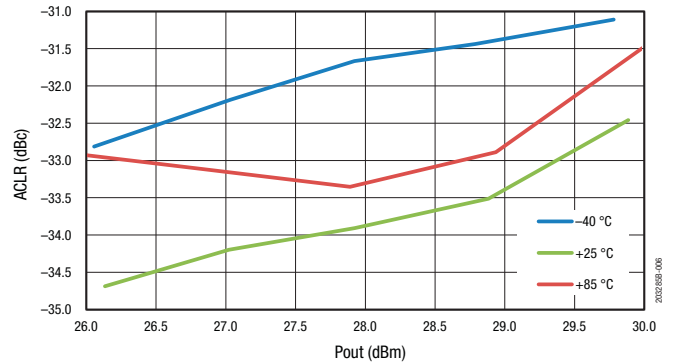

Figure 6. ACLR vs Pout Across Temperature (20 MHz LTE, 8.5 dB PAR Signal)

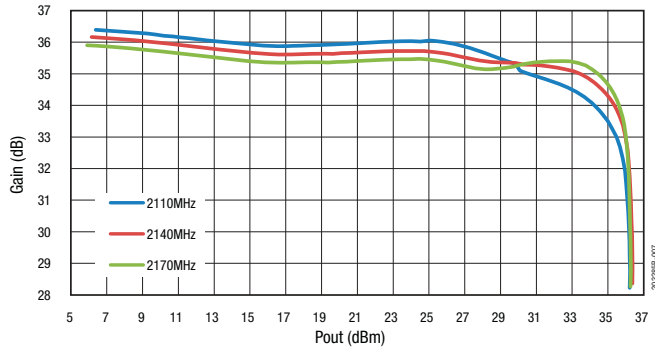

Figure 7. Gain vs Pout Across Frequency

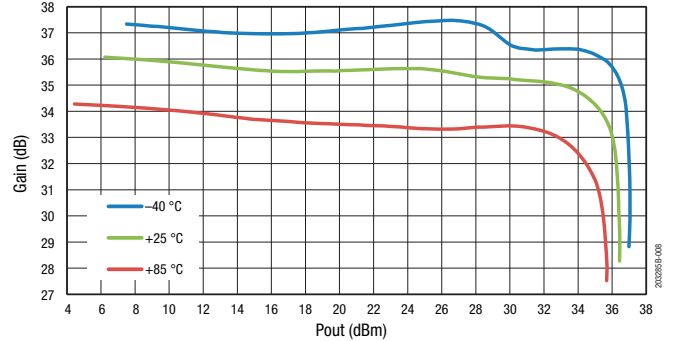

Figure 8. Gain vs Pout Across Temperature

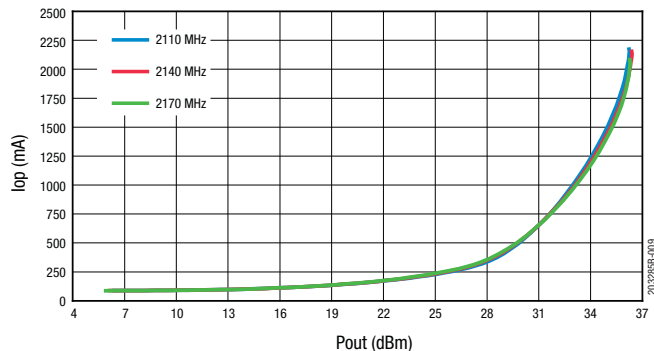

Figure 9. Iop vs Pout Across Frequency

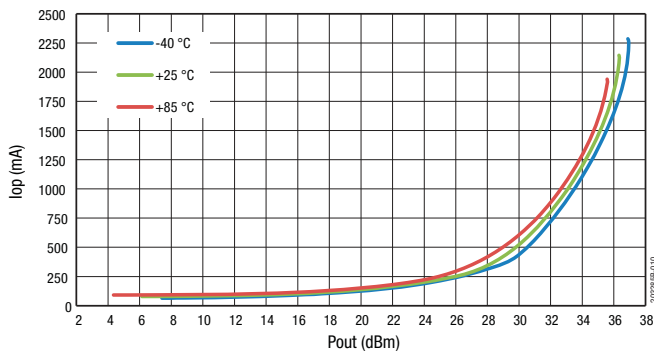

Figure 10. Iop vs Pout Across Temperature

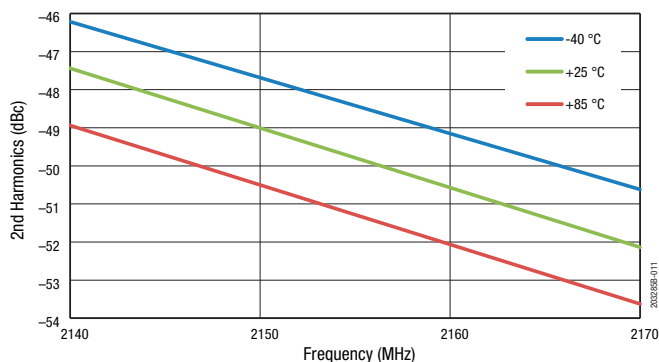

Figure 11. 2nd Harmonic @ +28 dBm vs Frequency Across Temperature

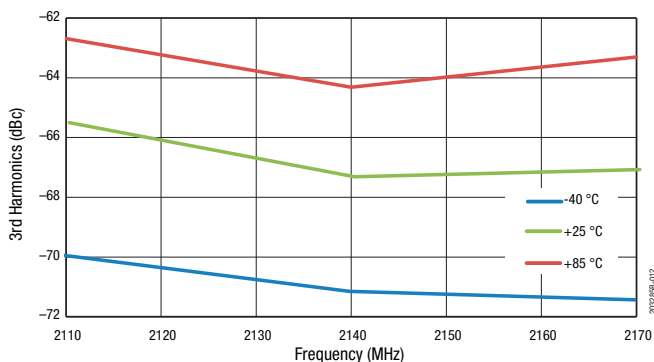

Figure 12. 3rd Harmonic @ +28 dBm vs Frequency Across Temperature

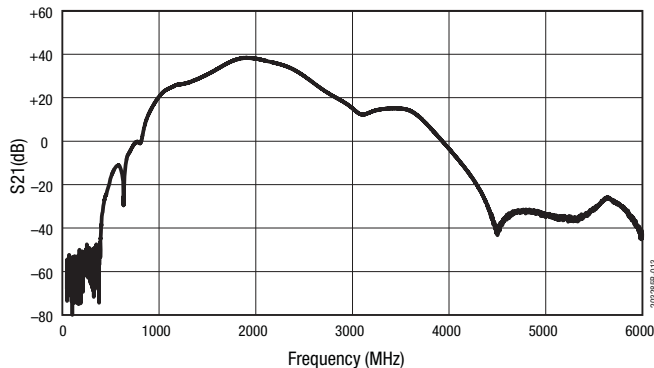

Figure 13. Gain vs Frequency (Small Signal, Pin = -30 dBm)

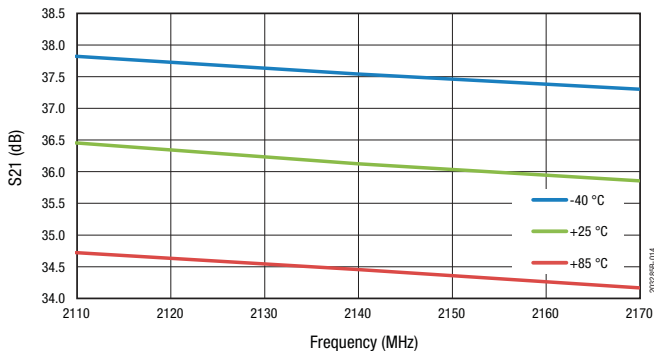

Figure 14. Gain vs Frequency Across Temperature (Small Signal, Pin = -30 dBm)

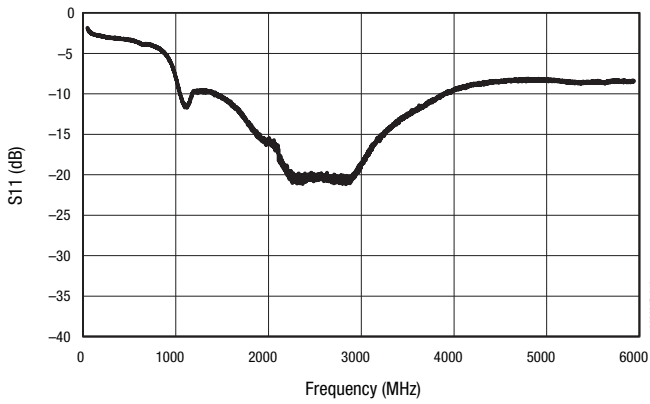

Figure 15. Input Return Loss vs Frequency (Small Signal, P_{IN} = -30 dBm)

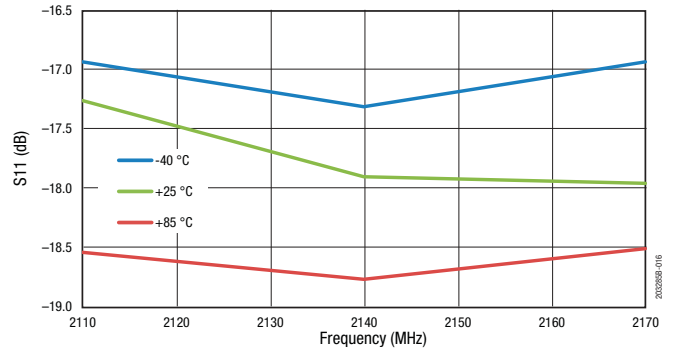

Figure 16. Input Return Loss vs Frequency Across Temperature (Small Signal, P_{IN} = -30 dBm)

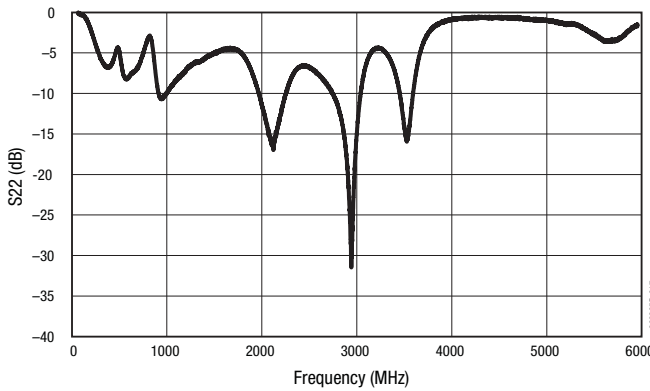

Figure 17. Output Return Loss vs Frequency (Small Signal, P_{IN} = -30 dBm)

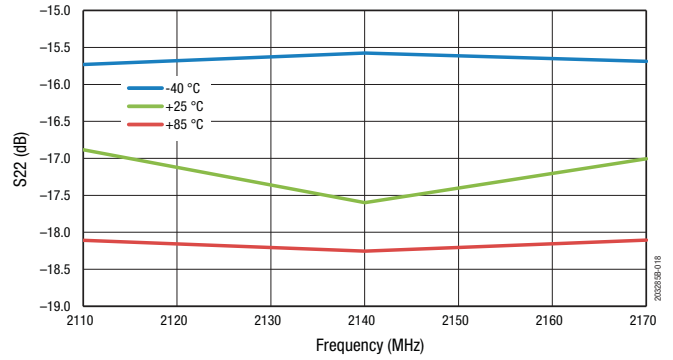

Figure 18. Output Return Loss vs Frequency Across Temperature (Small Signal, P_{IN} = -30 dBm)

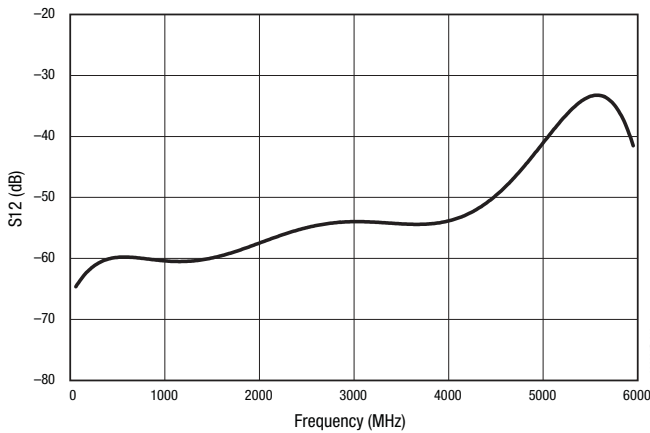

Figure 19. Reverse Isolation vs Frequency (Small Signal, P_{IN} = -30 dBm)

Evaluation Board Description

The SKY66294-11 Evaluation Board is used to test the performance of the SKY66294-11 PA. An Evaluation Board schematic is provided in Figure 20. Table 6 provides the Bill of Materials (BOM) list for Evaluation Board components.

An assembly drawing for the Evaluation Board is shown in Figure 21. Board layer details are shown in Figure 22. Layer detail physical characteristics are noted in Figure 23.

Circuit Design Considerations

The following design considerations are general in nature and must be followed regardless of final use or configuration:

- Paths to ground should be made as short as possible.
- The ground pad of the SKY66294-11 has special electrical and thermal grounding requirements. This pad is the main thermal conduit for heat dissipation. Because the circuit board acts as the heat sink, it must shunt as much heat as possible from the device.

Therefore, design the connection to the ground pad to dissipate the maximum wattage produced by the circuit board. Multiple vias to the grounding layer are required.

NOTE: A poor connection between the ground pad and ground increases junction temperature (T_J), which reduces the life of the device.

Evaluation Board Test Procedure

Turn-On Sequence

1. Connect 50 Ω Test Equipment or Load to the input and output RF ports of the Evaluation Board.
2. Connect the DC ground.
3. Connect all VCCs and VBIAS lines to a +5 V supply. Connect PAEN to a 2.0 V supply.
4. Without applying RF, turn on the 5 V supply, then turn on the 2 V PAEN.
5. Apply RF signal data at -30 dBm and observe that the gain of the device is approximately 36 dB. Begin measurements.

Turn-Off Sequence

1. Turn off the RF input to the device.
2. Turn off PAEN (set to 0 V).
3. Turn off all VCCs and VBIAS.

NOTE: It is important to adjust the VCC voltage sources so that +5 V is measured at the board. High collector currents drop the collector voltage significantly if long leads are used. Adjust the bias voltage to compensate.

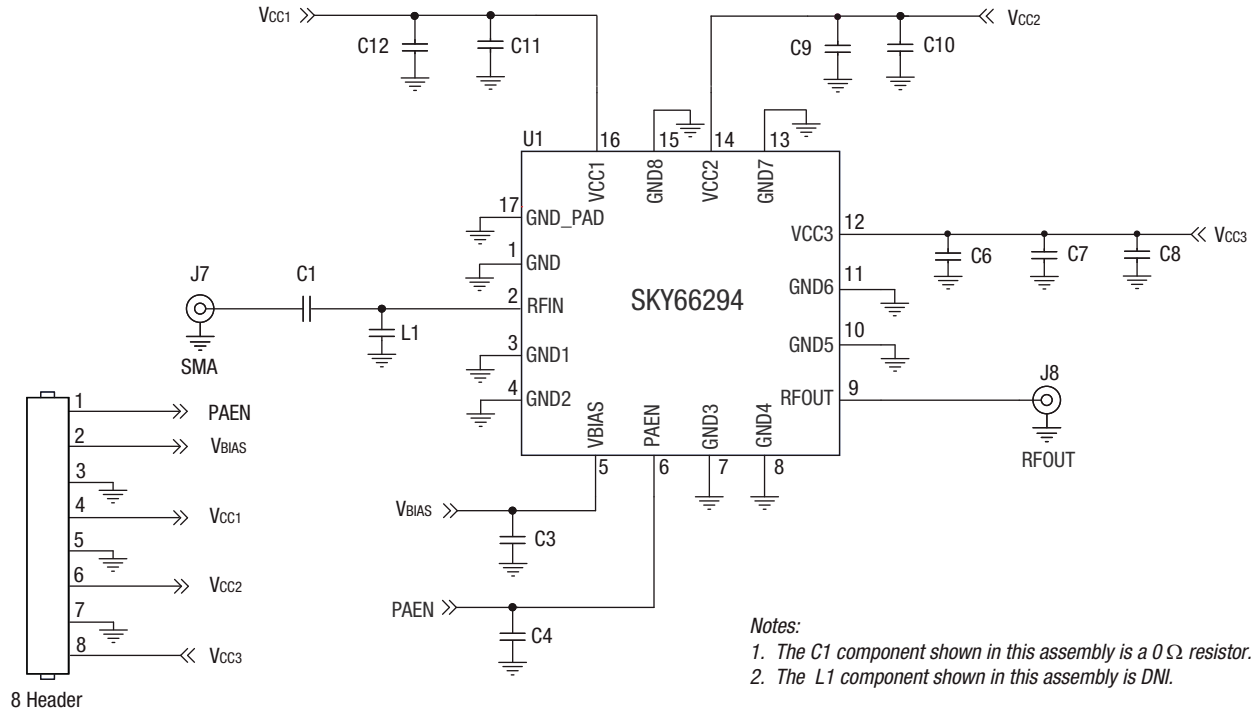

203285B-020

Figure 20. SKY66294-11 Evaluation Board Schematic

Table 6. SKY66294-11 Evaluation Board Bill of Materials (BOM)

| Component | Description | Size |
|-----------------|--|------|
| C1 | Resistor, 0 Ω , 0.063 W | 0402 |
| C3 | Ceramic capacitor, 1 μ F, 16 V, \pm 10% | 0402 |
| C4, C7, C9, C11 | Ceramic capacitor, 3300 pF, X7R, \pm 10%, 50 V | 0402 |
| C6 | Ceramic capacitor, 100 pF | 0402 |
| C8, C10, C12 | Ceramic capacitor, 10 μ F, 16 V, \pm 10% , X7R | 1206 |
| L1 | DNI | 0402 |
| TW21-D690-021 | Evaluation Board | - |

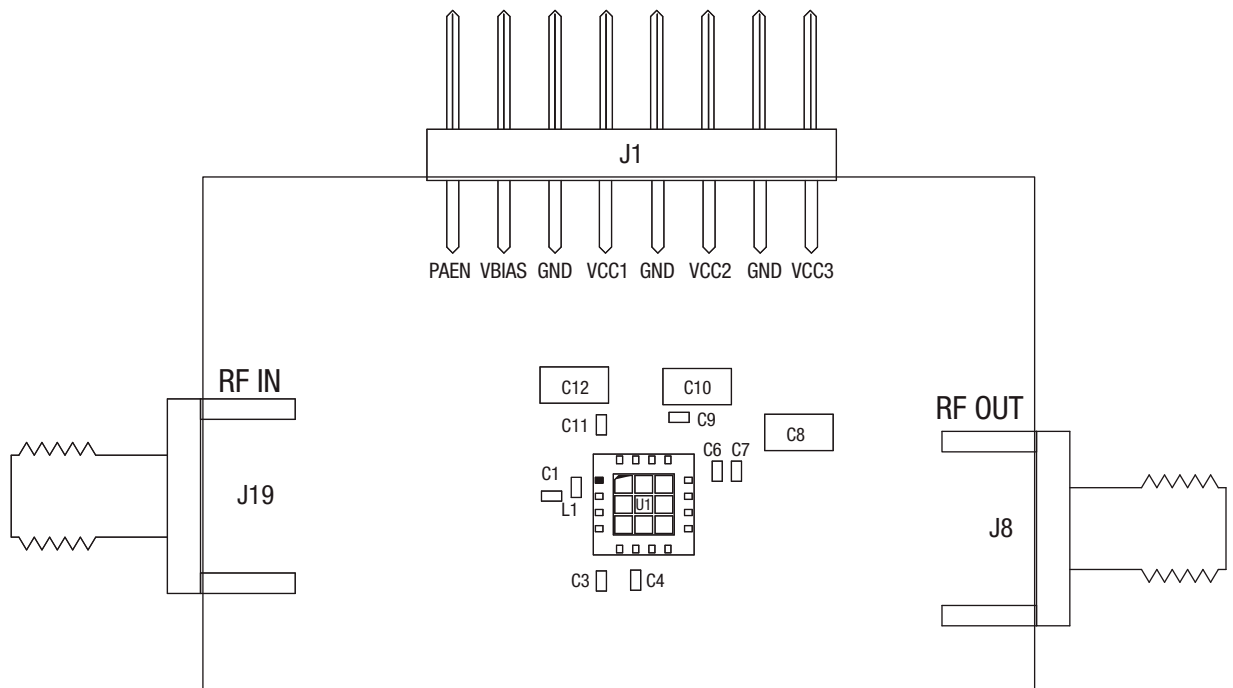

Notes:

1. Evaluation Board Gerber files are available on request.
2. The C1 component shown in this assembly is a 0 Ω resistor.
3. The L1 component shown in this assembly is DNI.

Figure 21. Evaluation Board Assembly Drawing

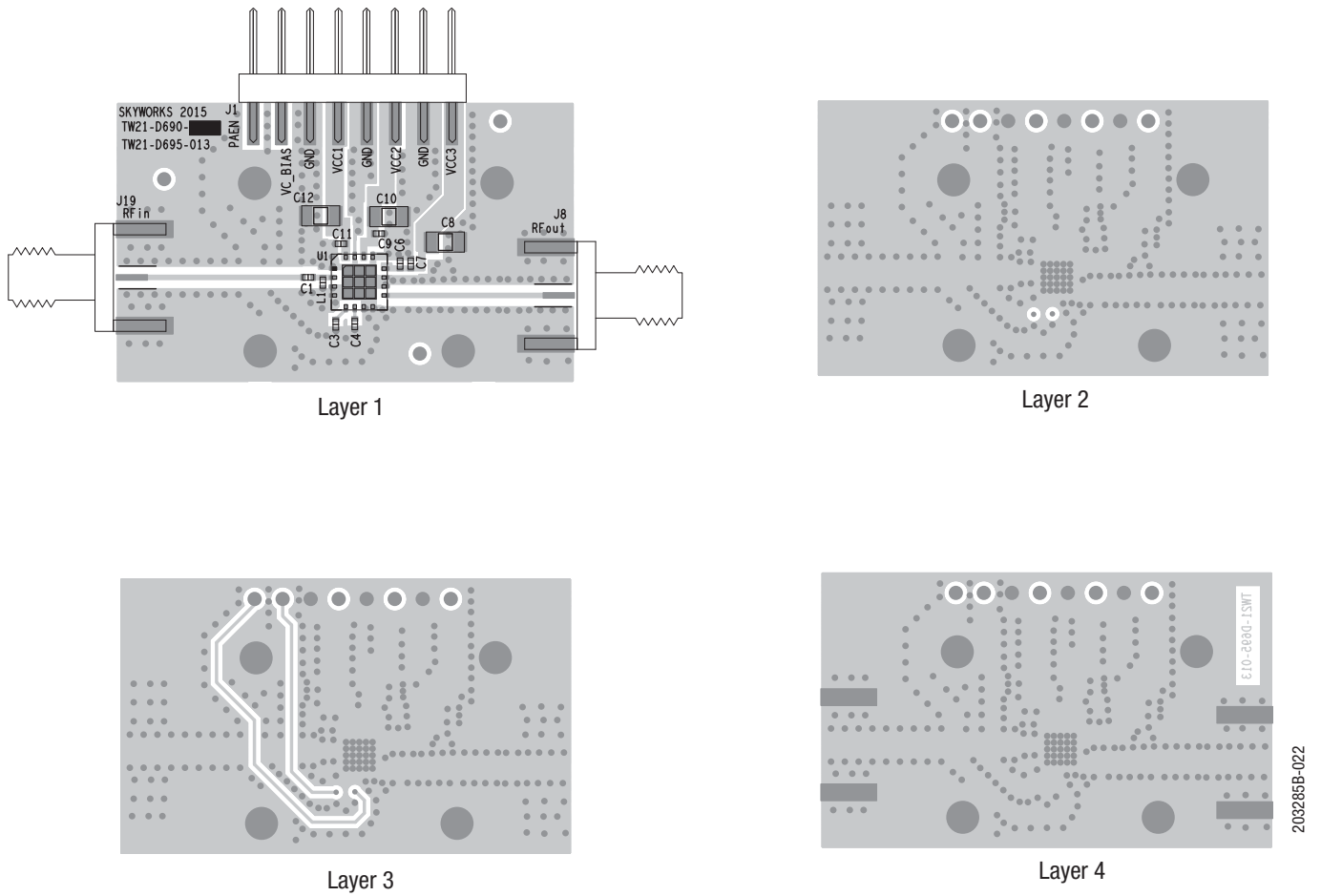

Figure 22. Board Layer Detail

| 50 Ohm | Cross Section | Name | Thickness (mm) | Materials |
|--------------|---------------|------------|----------------|---------------|
| W = 0.500 mm | | TMask | 0.010 | Solder Resist |
| | | L1 | 0.035 | Cu, 1 oz. |
| | | Dielectric | : 0.250 | R04350 |
| | | L2 | 0.035 | Cu, 1 oz. |
| | | Dielectric | : 0.350 | FR4 |
| | | L3 | 0.035 | Cu, 1 oz. |
| | | Dielectric | : 0.250 | FR4 |
| | | L4 | 0.035 | Cu, 1 oz. |
| | | BMask | 0.010 | Solder Resist |

203285B-023

Figure 23. Layer Detail Physical Characteristics

Application Circuit Notes

Center Ground. It is extremely important to sufficiently ground the bottom ground pad of the device for both thermal and stability reasons. Multiple small vias are acceptable and work well under the device if solder migration is an issue.

GND (pins 1, 3, 4, 7, 8, 10, 11, 13, and 15). Attach all ground pins to the RF ground plane with the largest diameter and lowest inductance via that the layout allows. Multiple small vias are acceptable and will work well under the device if solder migration is an issue.

VCBIAS (pin 5). The bias supply voltage for each stage, nominally set to +5 V.

RFOUT (pin 9). Amplifier RF output pin ($Z_0 = 50 \Omega$). The module includes an internal DC blocking capacitor. All impedance matching is provided internal to the module.

VCC1, VCC2, and VCC3 (pin 16, 15, and 12, respectively). Supply voltage for each stage collector bias is nominally set to 5 V. Bypass and decoupling capacitors C6 through C12 should be placed in the approximate location shown on the evaluation board assembly drawing, although exact placement is not critical.

RFIN (pin 2). Amplifier RF input pin ($Z_0 = 50 \Omega$). All impedance matching is provided internal to the module.

Package Dimensions

Typical part marking for the SKY66294-11 is shown in Figure 24. The PCB layout footprint for the SKY66294-11 is shown in Figure 25. Package dimensions are shown in Figure 26, and tape and reel dimensions are provided in Figure 27.

Package and Handling Information

Since the device package is sensitive to moisture absorption, it is baked and vacuum packed before shipping. Instructions on the shipping container label regarding exposure to moisture after the container seal is broken must be followed. Otherwise, problems related to moisture absorption may occur when the part is subjected to high temperature during solder assembly.

The SKY66294-11 is rated to Moisture Sensitivity Level 3 (MSL3) at 250 °C. It can be used for lead or lead-free soldering. For additional information, refer to Skyworks Application Note, *PCB Design and SMT Assembly/Rework Guidelines for MCM-L Packages*, document number 101752.

Care must be taken when attaching this product, whether it is done manually or in a production solder reflow environment. Production quantities of this product are shipped in a standard tape and reel format.

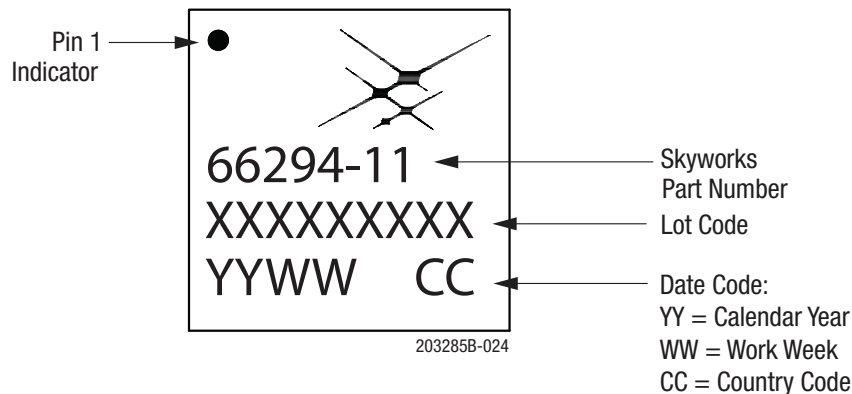
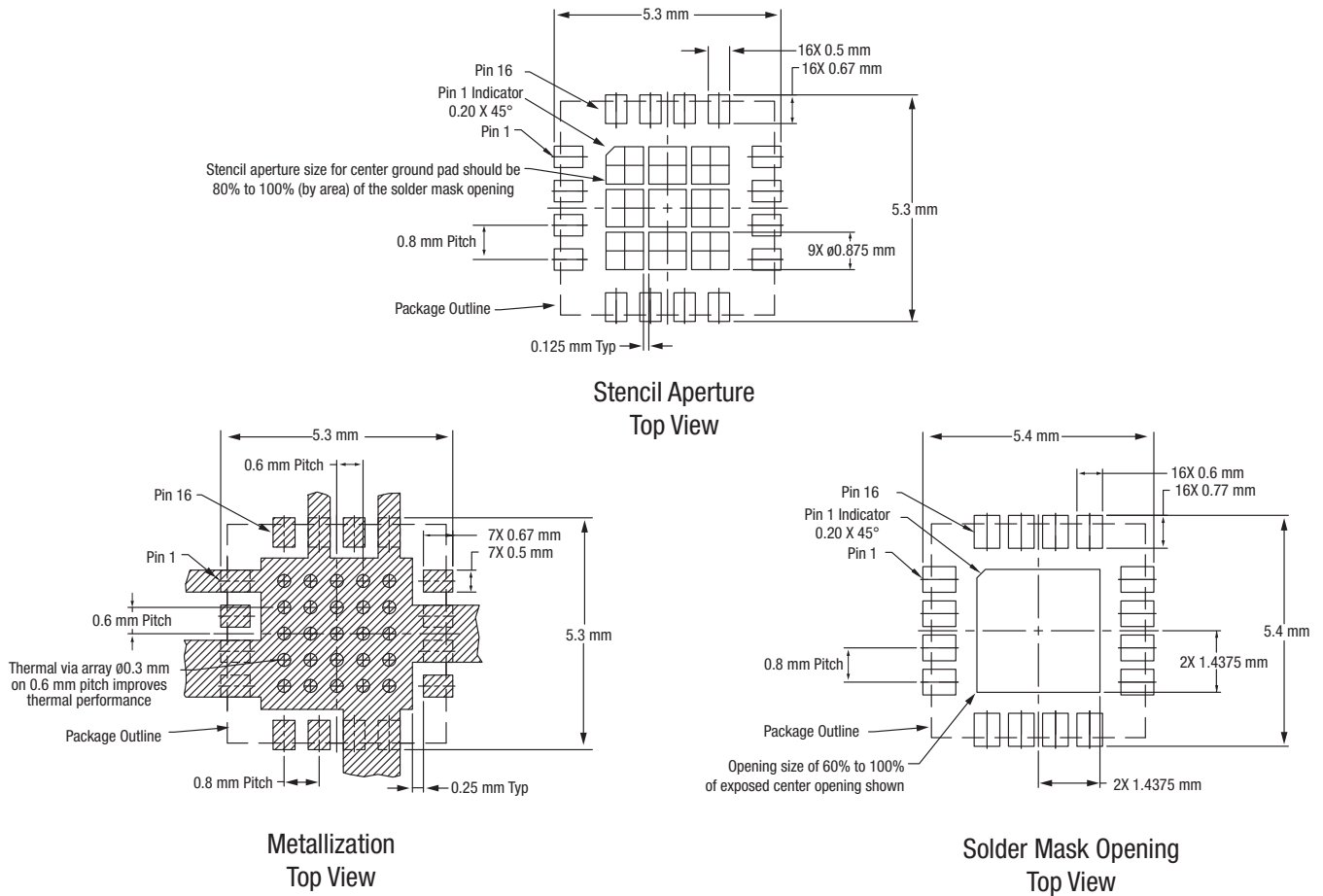

Figure 24. Typical Part Marking for the SKY66294-11



Notes:

1. Thermal vias should be resin filled and capped in accordance with IPC-4761 type VII vias.
2. Recommended Cu thickness is 30 to 35 μm .

203285B-025

Figure 25. SKY66294-11 PCB Layout Footprint

DATA SHEET • SKY66294-11: 2000 TO 2300 MHz HIGH-EFFICIENCY 4 W POWER AMPLIFIER

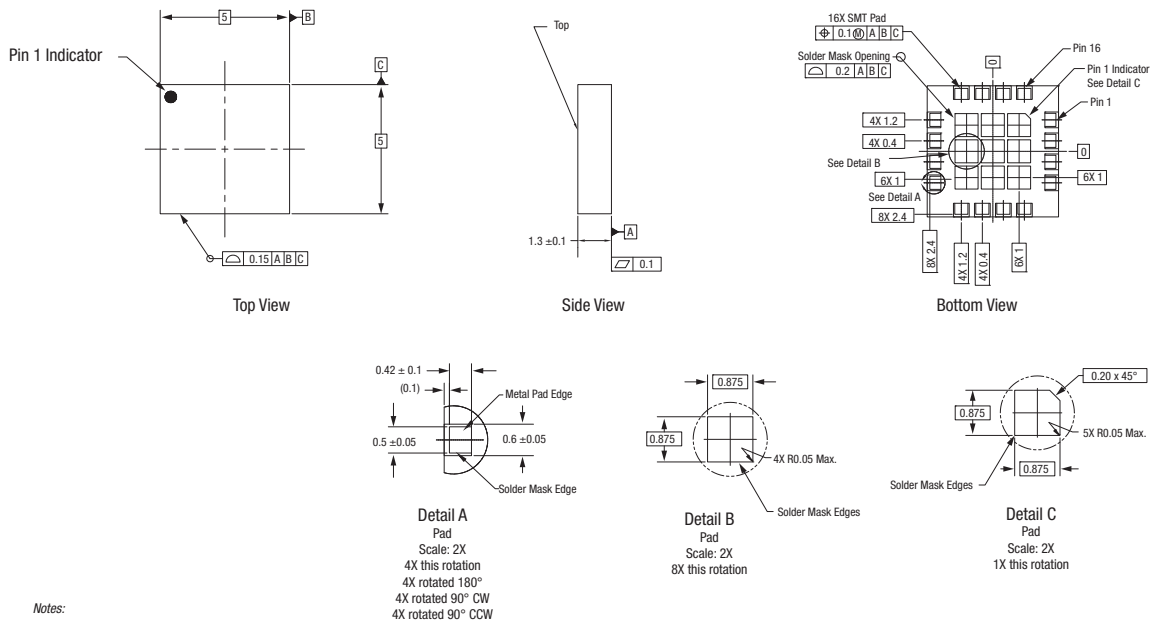

203285B-026

Figure 26. SKY66294-11 Package Dimensions

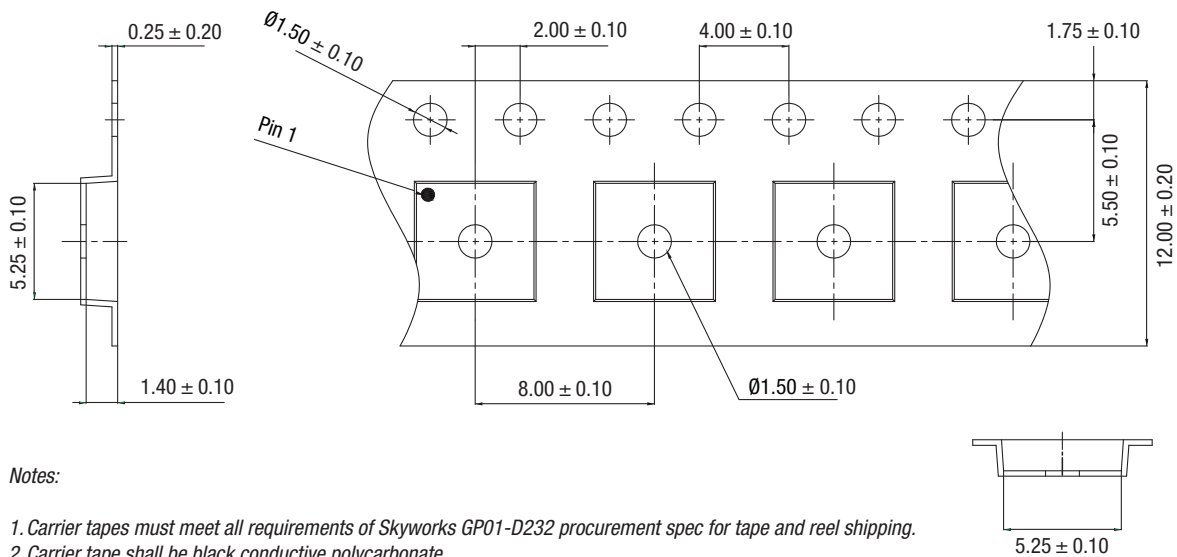

203285B-027

Figure 27. SKY66294-11 Tape and Reel Dimensions

Ordering Information

| Model Name | Manufacturing Part Number | Evaluation Board Part Number |
|---|---------------------------|------------------------------|
| SKY66294-11: 2000 to 2300 MHz High-Efficiency 4 W Power Amplifier | SKY66294-11 | SKY66294-11-EVB |

Copyright © 2013-2014, 2016-2017 Skyworks Solutions, Inc. All Rights Reserved.

Information in this document is provided in connection with Skyworks Solutions, Inc. (“Skyworks”) products or services. These materials, including the information contained herein, are provided by Skyworks as a service to its customers and may be used for informational purposes only by the customer. Skyworks assumes no responsibility for errors or omissions in these materials or the information contained herein. Skyworks may change its documentation, products, services, specifications or product descriptions at any time, without notice. Skyworks makes no commitment to update the materials or information and shall have no responsibility whatsoever for conflicts, incompatibilities, or other difficulties arising from any future changes.

No license, whether express, implied, by estoppel or otherwise, is granted to any intellectual property rights by this document. Skyworks assumes no liability for any materials, products or information provided hereunder, including the sale, distribution, reproduction or use of Skyworks products, information or materials, except as may be provided in Skyworks Terms and Conditions of Sale.

THE MATERIALS, PRODUCTS AND INFORMATION ARE PROVIDED “AS IS” WITHOUT WARRANTY OF ANY KIND, WHETHER EXPRESS, IMPLIED, STATUTORY, OR OTHERWISE, INCLUDING FITNESS FOR A PARTICULAR PURPOSE OR USE, MERCHANTABILITY, PERFORMANCE, QUALITY OR NON-INFRINGEMENT OF ANY INTELLECTUAL PROPERTY RIGHT; ALL SUCH WARRANTIES ARE HEREBY EXPRESSLY DISCLAIMED. SKYWORKS DOES NOT WARRANT THE ACCURACY OR COMPLETENESS OF THE INFORMATION, TEXT, GRAPHICS OR OTHER ITEMS CONTAINED WITHIN THESE MATERIALS. SKYWORKS SHALL NOT BE LIABLE FOR ANY DAMAGES, INCLUDING BUT NOT LIMITED TO ANY SPECIAL, INDIRECT, INCIDENTAL, STATUTORY, OR CONSEQUENTIAL DAMAGES, INCLUDING WITHOUT LIMITATION, LOST REVENUES OR LOST PROFITS THAT MAY RESULT FROM THE USE OF THE MATERIALS OR INFORMATION, WHETHER OR NOT THE RECIPIENT OF MATERIALS HAS BEEN ADVISED OF THE POSSIBILITY OF SUCH DAMAGE.

Skyworks products are not intended for use in medical, lifesaving or life-sustaining applications, or other equipment in which the failure of the Skyworks products could lead to personal injury, death, physical or environmental damage. Skyworks customers using or selling Skyworks products for use in such applications do so at their own risk and agree to fully indemnify Skyworks for any damages resulting from such improper use or sale.

Customers are responsible for their products and applications using Skyworks products, which may deviate from published specifications as a result of design defects, errors, or operation of products outside of published parameters or design specifications. Customers should include design and operating safeguards to minimize these and other risks. Skyworks assumes no liability for applications assistance, customer product design, or damage to any equipment resulting from the use of Skyworks products outside of stated published specifications or parameters.

Skyworks and the Skyworks symbol are trademarks or registered trademarks of Skyworks Solutions, Inc., in the United States and other countries. Third-party brands and names are for identification purposes only, and are the property of their respective owners. Additional information, including relevant terms and conditions, posted at www.skyworksinc.com, are incorporated by reference.

Компания «Океан Электроники» предлагает заключение долгосрочных отношений при поставках импортных электронных компонентов на взаимовыгодных условиях!

Наши преимущества:

- Поставка оригинальных импортных электронных компонентов напрямую с производств Америки, Европы и Азии, а так же с крупнейших складов мира;
- Широкая линейка поставок активных и пассивных импортных электронных компонентов (более 30 млн. наименований);
- Поставка сложных, дефицитных, либо снятых с производства позиций;
- Оперативные сроки поставки под заказ (от 5 рабочих дней);
- Экспресс доставка в любую точку России;
- Помощь Конструкторского Отдела и консультации квалифицированных инженеров;
- Техническая поддержка проекта, помощь в подборе аналогов, поставка прототипов;
- Поставка электронных компонентов под контролем ВП;
- Система менеджмента качества сертифицирована по Международному стандарту ISO 9001;
- При необходимости вся продукция военного и аэрокосмического назначения проходит испытания и сертификацию в лаборатории (по согласованию с заказчиком);
- Поставка специализированных компонентов военного и аэрокосмического уровня качества (Xilinx, Altera, Analog Devices, Intersil, Interpoint, Microsemi, Actel, Aeroflex, Peregrine, VPT, Syfer, Eurofarad, Texas Instruments, MS Kennedy, Miteq, Cobham, E2V, MA-COM, Hittite, Mini-Circuits, General Dynamics и др.);

Компания «Океан Электроники» является официальным дистрибьютором и эксклюзивным представителем в России одного из крупнейших производителей разъемов военного и аэрокосмического назначения «JONHON», а так же официальным дистрибьютором и эксклюзивным представителем в России производителя высокотехнологичных и надежных решений для передачи СВЧ сигналов «FORSTAR».



JONHON

«JONHON» (основан в 1970 г.)

Разъемы специального, военного и аэрокосмического назначения:

(Применяются в военной, авиационной, аэрокосмической, морской, железнодорожной, горно- и нефтедобывающей отраслях промышленности)

«FORSTAR» (основан в 1998 г.)

ВЧ соединители, коаксиальные кабели,
кабельные сборки и микроволновые компоненты:

(Применяются в телекоммуникациях гражданского и специального назначения, в средствах связи, РЛС, а так же военной, авиационной и аэрокосмической отраслях промышленности).



Телефон: 8 (812) 309-75-97 (многоканальный)

Факс: 8 (812) 320-03-32

Электронная почта: ocean@oceanchips.ru

Web: <http://oceanchips.ru/>

Адрес: 198099, г. Санкт-Петербург, ул. Калинина, д. 2, корп. 4, лит. А