

## Normally – OFF Silicon Carbide Super Junction Transistor

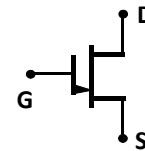
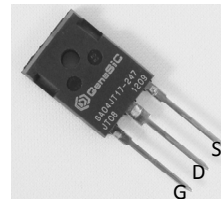
|              |   |        |
|--------------|---|--------|
| $V_{DS}$     | = | 1700 V |
| $V_{DS(ON)}$ | = | 2.0 V  |
| $I_D$        | = | 4 A    |
| $R_{DS(ON)}$ | = | 500 mΩ |

### Features

- 175 °C maximum operating temperature
- Temperature independent switching performance
- Gate oxide free SiC switch
- Suitable for connecting an anti-parallel diode
- Positive temperature coefficient for easy paralleling
- Low gate charge
- Low intrinsic capacitance

### Package

- RoHS Compliant



**TO-247AB**

### Advantages

- Low switching losses
- Higher efficiency
- High temperature operation
- High short circuit withstand capability

### Applications

- Down Hole Oil Drilling, Geothermal Instrumentation
- Hybrid Electric Vehicles (HEV)
- Solar Inverters
- Switched-Mode Power Supply (SMPS)
- Power Factor Correction (PFC)
- Induction Heating
- Uninterruptible Power Supply (UPS)
- Motor Drives

### Maximum Ratings unless otherwise specified

| Parameter                      | Symbol    | Conditions                       | Values     | Unit       |
|--------------------------------|-----------|----------------------------------|------------|------------|
| Drain – Source Voltage         | $V_{DS}$  | $V_{GS} = 0 V$                   | 1700       | V          |
| Continuous Drain Current       | $I_D$     | $T_{C,MAX} = 95\text{ }^\circ C$ | 4          | A          |
| Gate Peak Current              | $I_{GM}$  |                                  | 5          | A          |
| Reverse Gate – Source Voltage  | $V_{SG}$  |                                  | 60         | V          |
| Reverse Drain – Source Voltage | $V_{SD}$  |                                  | 50         | V          |
| Power Dissipation              | $P_{tot}$ | $T_C = 25\text{ }^\circ C$       | 91         | W          |
| Storage Temperature            | $T_{stg}$ |                                  | -55 to 175 | $^\circ C$ |

### Electrical Characteristics at $T_j = 175\text{ }^\circ C$ , unless otherwise specified

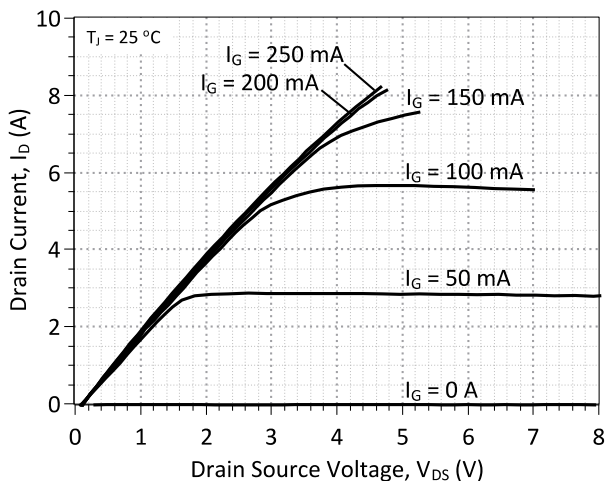
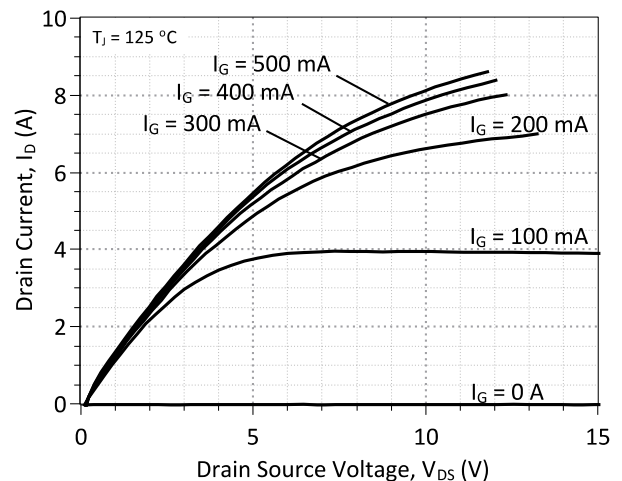
| Parameter                    | Symbol        | Conditions  | Values |      |      | Unit    |
|------------------------------|---------------|---|--------|------|------|---------|
|                              |               |   | min.   | typ. | max. |         |
| <b>On Characteristics</b>    |               |   |        |      |      |         |
| Drain – Source On Voltage    | $V_{DS(ON)}$  | $I_D = 4 A, I_G = 250 mA, T_j = 25\text{ }^\circ C$     | 2.0    |      |      | V       |
|                              |               | $I_D = 4 A, I_G = 500 mA, T_j = 125\text{ }^\circ C$    | 3.3    |      |      |         |
|                              |               | $I_D = 4 A, I_G = 500 mA, T_j = 175\text{ }^\circ C$    | 4.5    |      |      |         |
| Drain – Source On Resistance | $R_{DS(ON)}$  | $I_D = 4 A, I_G = 250 mA, T_j = 25\text{ }^\circ C$     | 500    |      |      | mΩ      |
|                              |               | $I_D = 4 A, I_G = 500 mA, T_j = 125\text{ }^\circ C$    | 800    |      |      |         |
|                              |               | $I_D = 4 A, I_G = 500 mA, T_j = 175\text{ }^\circ C$    | 1100   |      |      |         |
| Gate Forward Voltage         | $V_{GS(FWD)}$ | $I_G = 500 mA, T_j = 25\text{ }^\circ C$                | 3.3    |      |      | V       |
|                              |               | $I_G = 500 mA, T_j = 175\text{ }^\circ C$               | 3.2    |      |      |         |
| DC Current Gain              | $\beta$       | $V_{DS} = 5 V, I_D = 4 A, T_j = 25\text{ }^\circ C$     | 60     |      |      |         |
|                              |               | $V_{DS} = 5 V, I_D = 4 A, T_j = 175\text{ }^\circ C$    | 35     |      |      |         |
| <b>Off Characteristics</b>   |               |   |        |      |      |         |
| Drain Leakage Current        | $I_{DSS}$     | $V_R = 1700 V, V_{GS} = 0 V, T_j = 25\text{ }^\circ C$  | 0.5    |      |      | $\mu A$ |
|                              |               | $V_R = 1700 V, V_{GS} = 0 V, T_j = 125\text{ }^\circ C$ | 1.0    |      |      |         |
|                              |               | $V_R = 1700 V, V_{GS} = 0 V, T_j = 175\text{ }^\circ C$ | 2.0    |      |      |         |

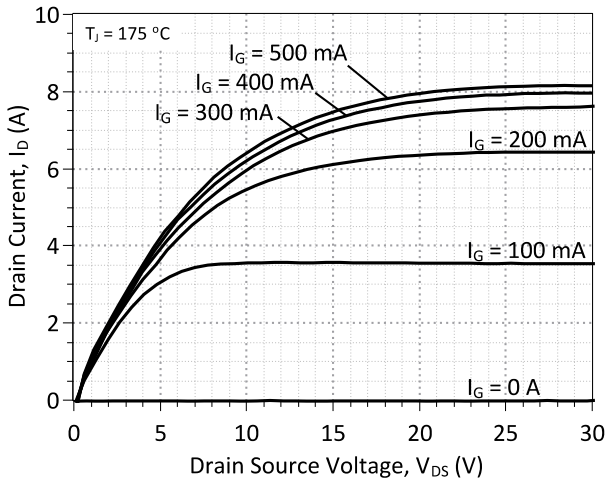
**Electrical Characteristics at  $T_j = 175\text{ }^\circ\text{C}$ , unless otherwise specified**

| Parameter                        | Symbol       | Conditions  | Values   |      |      | Unit          |               |
|----------------------------------|--------------|---|--|------|------|---------------|---------------|
|                                  |              |   | min.   | typ. | max. |               |               |
| <b>Switching Characteristics</b> |              |   |  |      |      |               |               |
| Turn On Delay Time               | $t_{d(on)}$  | $V_{DD} = 1100\text{ V}$ , $I_D = 4\text{ A}$ ,<br>$R_{G(on)} = R_{G(off)} = 44\ \Omega$ ,<br>$V_{GS} = -8/15\text{ V}$ , $L = 1.1\text{ mH}$ ,<br>FWD = GB05SLT12,<br>$T_j = 25\text{ }^\circ\text{C}$ |  | 35   |      | ns            |               |
| Rise Time                        | $t_r$        |   |  | 28   |      | ns            |               |
| Turn Off Delay Time              | $t_{d(off)}$ |   |  | 60   |      | ns            |               |
| Fall Time                        | $t_f$        |   |  | 50   |      | ns            |               |
| Turn-On Energy Per Pulse         | $E_{on}$     |   | Refer to Figure 11 for gate current waveform   |      | 323  |               | $\mu\text{J}$ |
| Turn-Off Energy Per Pulse        | $E_{off}$    |   |  |      | 60   |               | $\mu\text{J}$ |
| Total Switching Energy           | $E_{ts}$     |   |  |      | 383  |               | $\mu\text{J}$ |
| Turn On Delay Time               | $t_{d(on)}$  |   |  |      | 30   |               | ns            |
| Rise Time                        | $t_r$        |   |  |      | 14   |               | ns            |
| Turn Off Delay Time              | $t_{d(off)}$ |   | $V_{DD} = 1100\text{ V}$ , $I_D = 4\text{ A}$ ,<br>$R_{G(on)} = R_{G(off)} = 44\ \Omega$ ,<br>$V_{GS} = -8/15\text{ V}$ , $L = 1.1\text{ mH}$ ,<br>FWD = GB05SLT12,<br>$T_j = 175\text{ }^\circ\text{C}$ |      | 73   |               | ns            |
| Fall Time                        | $t_f$        |   |  | 58   |      | ns            |               |
| Turn-On Energy Per Pulse         | $E_{on}$     |   |  | 172  |      | $\mu\text{J}$ |               |
| Turn-Off Energy Per Pulse        | $E_{off}$    |   |  | 73   |      | $\mu\text{J}$ |               |
| Total Switching Energy           | $E_{ts}$     |   |  | 245  |      | $\mu\text{J}$ |               |

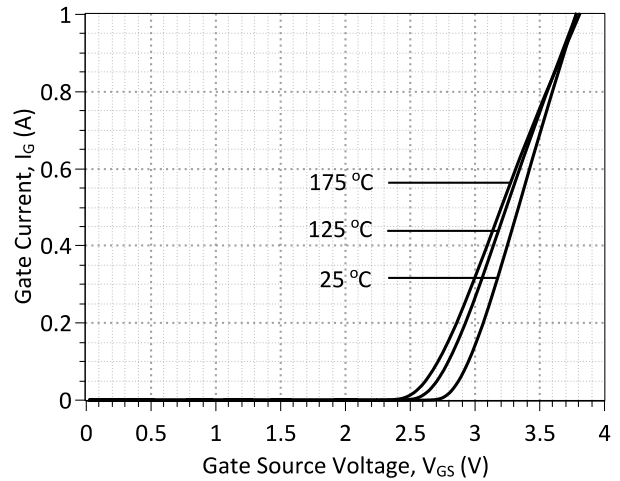
**Thermal Characteristics**

|                                     |            |      |                    |
|-------------------------------------|------------|------|--------------------|
| Thermal resistance, junction - case | $R_{thJC}$ | 1.64 | $^\circ\text{C/W}$ |
|-------------------------------------|------------|------|--------------------|

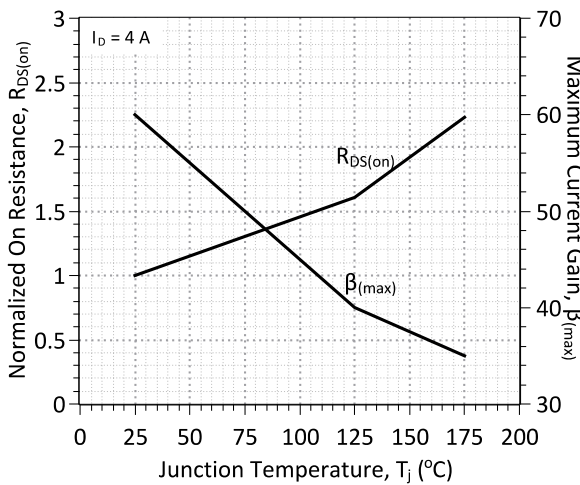

**Figure 1: Typical Output Characteristics at  $25\text{ }^\circ\text{C}$** 

**Figure 2: Typical Output Characteristics at  $125\text{ }^\circ\text{C}$**



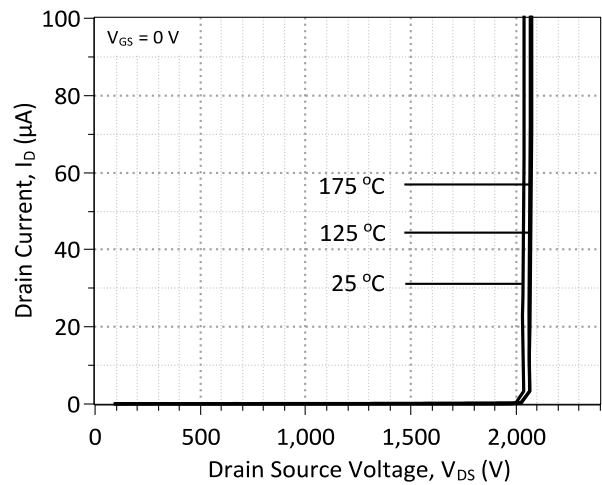
**Figure 3: Typical Output Characteristics at 175 °C**



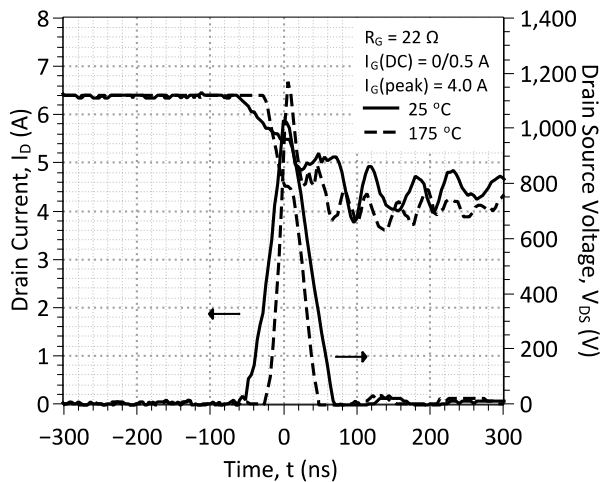
**Figure 4: Typical Gate Source I-V Characteristics vs. Temperature**



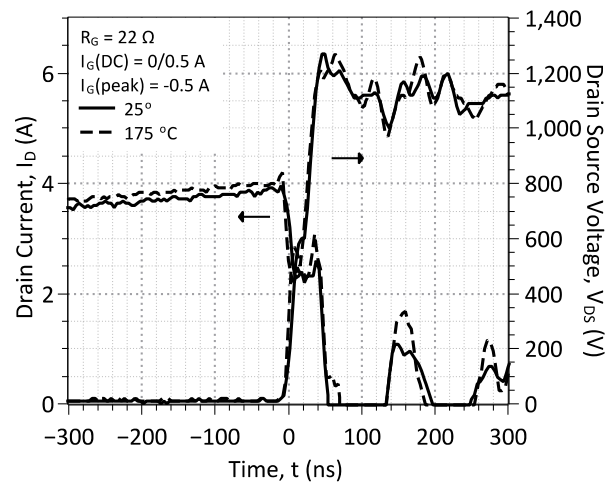
**Figure 5: Normalized On-Resistance and Current Gain vs. Temperature**



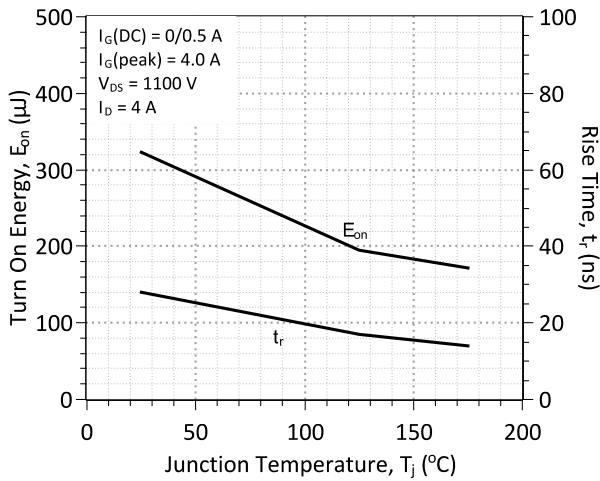
**Figure 6: Typical Blocking Characteristics**



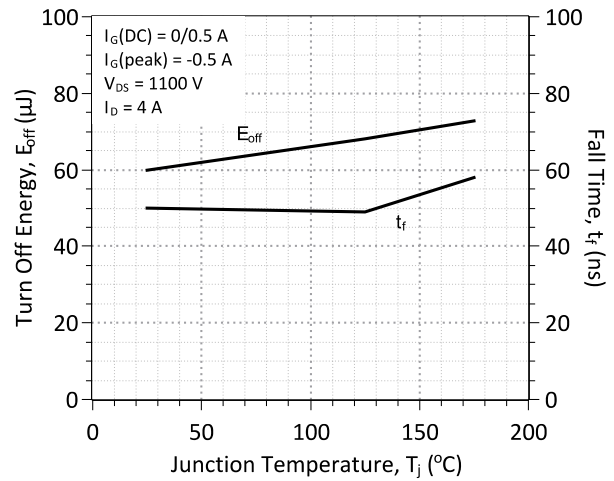
**Figure 7: Typical Hard-switched Turn On Waveforms**



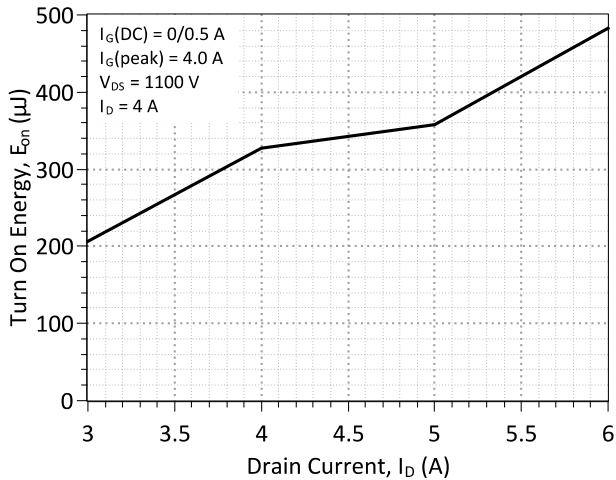
**Figure 8: Typical Hard-switched Turn Off Waveforms**



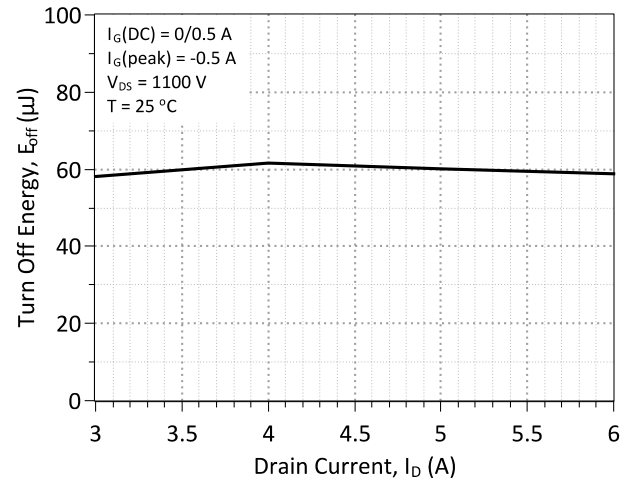
**Figure 9: Typical Turn On Energy Losses and Switching Times vs. Temperature**



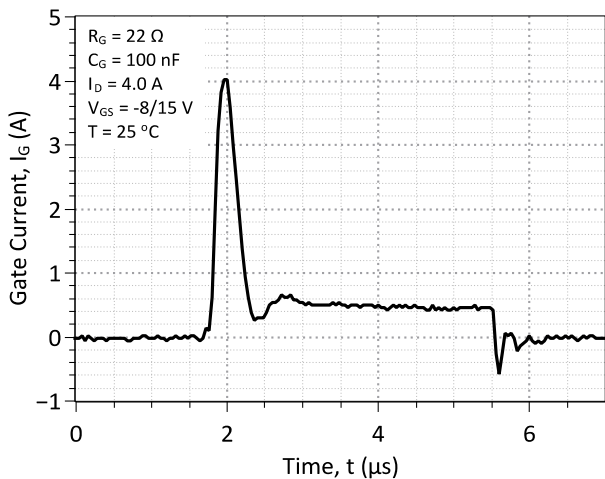
**Figure 10: Typical Turn Off Energy Losses and Switching Times vs. Temperature**



**Figure 11: Typical Turn On Energy Losses vs. Drain Current**



**Figure 12: Typical Turn Off Energy Losses vs. Drain Current**



**Figure 13: Typical Gate Current Waveform**

### Gate Drive Technique (Option #1)

To drive the GA04JT17-247 with the lowest gate drive losses, a custom-designed, dual voltage source gate drive configuration is recommended [for example, see Figure 5(a) in J. Rabkowski et al. IEEE Trans. Power Electronics 27(5), 2633-2642 (2012)]. More details on using this optimized gate drive technique will be made available shortly. An effective simple alternative for ultra-fast switching of the GA04JT17-247 is available below.

### Gate Drive Technique (Option #2)

The GA04JT17-247 can be effectively driven using the IXYS IXDN614 / IXDD614 non-inverting gate driver IC or a comparable product. A typical gate driver configuration along with component values using this driver is offered below. Additional information is available from the manufacturer at [www.ixys.com](http://www.ixys.com).

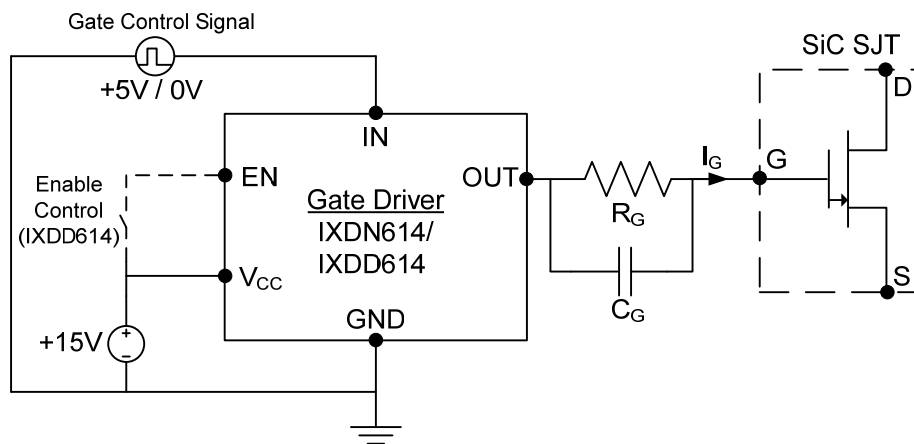
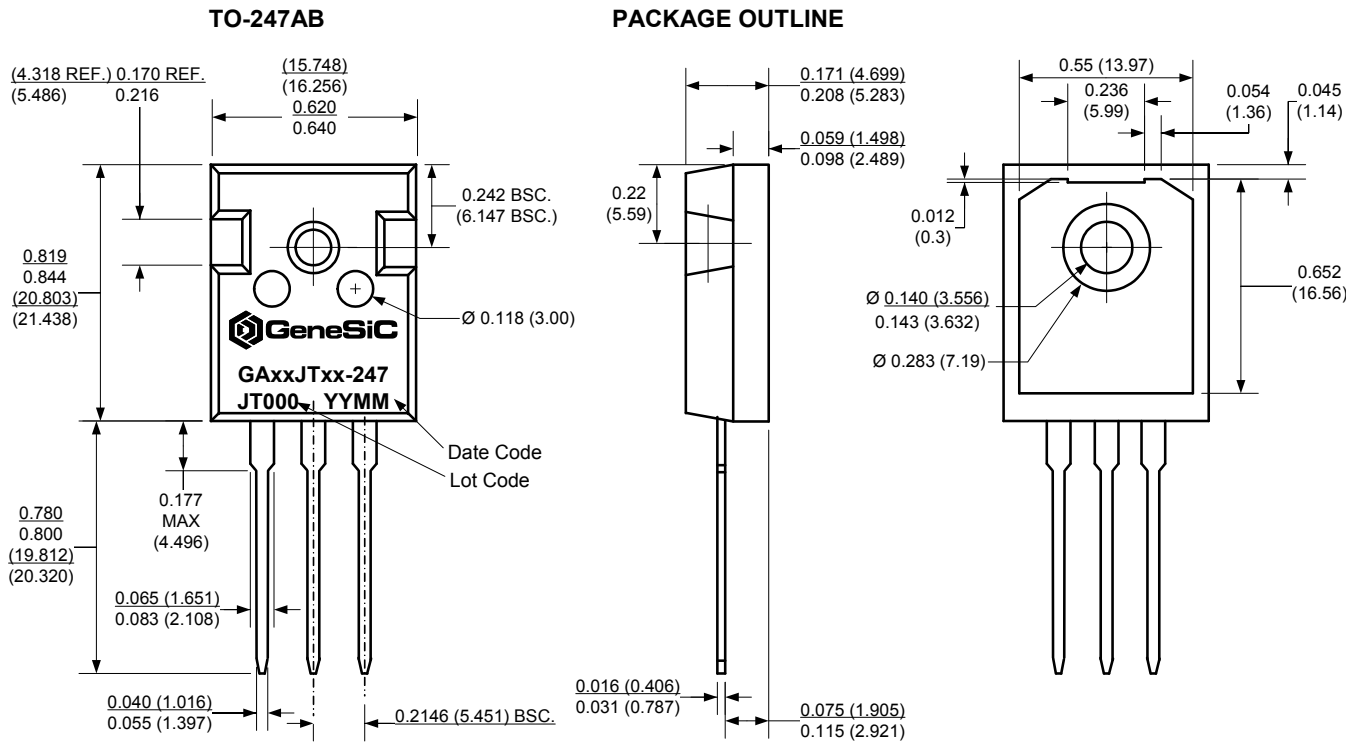


Figure 14: Recommended Gate Diver Configuration (Option #2)

| Parameter                                 | Symbol    | Conditions          | Values             |      |                    | Unit     |
|---|-----------|---------------------|--------------------|------|--------------------|----------|
|   |           |                     | min.               | typ. | max.               |          |
| <b>Gate Driver Pins (IXDD614/IXDN614)</b> |           |                     |                    |      |                    |          |
| Supply Voltage                            | $V_{CC}$  |                     | -0.3               | 15   | 40                 | V        |
| Gate Control Input Signal, Low            | IN        |                     | -5.0               | 0    | 0.8                | V        |
| Gate Control Input Signal, High           | IN        |                     | 3.0                | 5.0  | $V_{CC}+0.3$       | V        |
| Enable, Low                               | EN        | IXDD614 Only        |                    |      | $1/3 \cdot V_{CC}$ | V        |
| Enable, High                              | EN        | IXDD614 Only        | $2/3 \cdot V_{CC}$ |      |                    | V        |
| Output Voltage, Low                       | $V_{OUT}$ |                     |                    |      | 0.025              | V        |
| Output Voltage, High                      | $V_{OUT}$ |                     | $V_{CC}-0.025$     |      |                    | V        |
| Output Current, Peak                      | $I_{OUT}$ | Package Limited     |                    | 4.5  | 14                 | A        |
| Output Current, Continuous                | $I_{OUT}$ |                     |                    | 0.5  | 4.0                | A        |
| <b>Passive Gate Components</b>            |           |                     |                    |      |                    |          |
| Gate Resistance                           | $R_G$     | $I_G \approx 0.5$ A | 5                  | 22   |                    | $\Omega$ |
| Gate Capacitance                          | $C_G$     | $I_G \approx 0.5$ A |                    | 100  |                    | nF       |

**Package Dimensions:**



- NOTE**
1. CONTROLLED DIMENSION IS INCH. DIMENSION IN BRACKET IS MILLIMETER.
  2. DIMENSIONS DO NOT INCLUDE END FLASH, MOLD FLASH, MATERIAL PROTRUSIONS

| Revision History |          |                                    |            |
|------------------|----------|------------------------------------|------------|
| Date             | Revision | Comments                           | Supersedes |
| 2013/02/21       | 1        | Revised electrical characteristics |            |
| 2012/12/03       | 0        | Initial release                    |            |

Published by  
 GeneSiC Semiconductor, Inc.  
 43670 Trade Center Place Suite 155  
 Dulles, VA 20166

GeneSiC Semiconductor, Inc. reserves right to make changes to the product specifications and data in this document without notice.

GeneSiC disclaims all and any warranty and liability arising out of use or application of any product. No license, express or implied to any intellectual property rights is granted by this document.

Unless otherwise expressly indicated, GeneSiC products are not designed, tested or authorized for use in life-saving, medical, aircraft navigation, communication, air traffic control and weapons systems, nor in applications where their failure may result in death, personal injury and/or property damage.

Компания «Океан Электроники» предлагает заключение долгосрочных отношений при поставках импортных электронных компонентов на взаимовыгодных условиях!

Наши преимущества:

- Поставка оригинальных импортных электронных компонентов напрямую с производств Америки, Европы и Азии, а так же с крупнейших складов мира;
- Широкая линейка поставок активных и пассивных импортных электронных компонентов (более 30 млн. наименований);
- Поставка сложных, дефицитных, либо снятых с производства позиций;
- Оперативные сроки поставки под заказ (от 5 рабочих дней);
- Экспресс доставка в любую точку России;
- Помощь Конструкторского Отдела и консультации квалифицированных инженеров;
- Техническая поддержка проекта, помощь в подборе аналогов, поставка прототипов;
- Поставка электронных компонентов под контролем ВП;
- Система менеджмента качества сертифицирована по Международному стандарту ISO 9001;
- При необходимости вся продукция военного и аэрокосмического назначения проходит испытания и сертификацию в лаборатории (по согласованию с заказчиком);
- Поставка специализированных компонентов военного и аэрокосмического уровня качества (Xilinx, Altera, Analog Devices, Intersil, Interpoint, Microsemi, Actel, Aeroflex, Peregrine, VPT, Syfer, Eurofarad, Texas Instruments, MS Kennedy, Miteq, Cobham, E2V, MA-COM, Hittite, Mini-Circuits, General Dynamics и др.);

Компания «Океан Электроники» является официальным дистрибьютором и эксклюзивным представителем в России одного из крупнейших производителей разъемов военного и аэрокосмического назначения «JONHON», а так же официальным дистрибьютором и эксклюзивным представителем в России производителя высокотехнологичных и надежных решений для передачи СВЧ сигналов «FORSTAR».



## JONHON

«JONHON» (основан в 1970 г.)

Разъемы специального, военного и аэрокосмического назначения:

(Применяются в военной, авиационной, аэрокосмической, морской, железнодорожной, горно- и нефтедобывающей отраслях промышленности)

«FORSTAR» (основан в 1998 г.)

ВЧ соединители, коаксиальные кабели, кабельные сборки и микроволновые компоненты:

(Применяются в телекоммуникациях гражданского и специального назначения, в средствах связи, РЛС, а так же военной, авиационной и аэрокосмической отраслях промышленности).



Телефон: 8 (812) 309-75-97 (многоканальный)

Факс: 8 (812) 320-03-32

Электронная почта: [ocean@oceanchips.ru](mailto:ocean@oceanchips.ru)

Web: <http://oceanchips.ru/>

Адрес: 198099, г. Санкт-Петербург, ул. Калинина, д. 2, корп. 4, лит. А