

Optocoupler, Phototriac Output, High dV/dt, Low Input Current

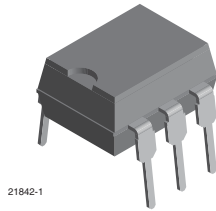

21842-1

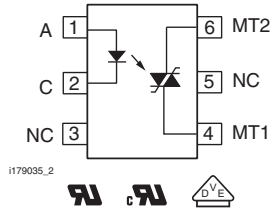

1179035_2



DESCRIPTION

The IL420 and IL4208 consists of a GaAs IRLED optically coupled to a photosensitive non-zero crossing TRIAC network. The TRIAC consists of two inverse parallel connected monolithic SCRs. These three semiconductors are assembled in a six pin dual in-line package.

High input sensitivity is achieved by using an emitter follower phototransistor and a cascaded SCR predriver resulting in an LED trigger current of less than 2 mA (DC).

The use of a proprietary dV/dt clam results in a static dV/dt of greater than 10 kV/μs. This clamp circuit has a MOSFET that is enhanced when high dV/dt spikes occur between MT1 and MT2 of the TRIAC. When conducting, the FET clamps the base of the phototransistors, disabling the first stage SCR predriver.

The 600 V, 800 V blocking voltage permits control of offline voltages up to 240 V_{AC}, with a safety factor of more than two, and is sufficient for as much as 380 V_{AC}.

The IL420, IL4208 isolates low-voltage logic from 120 V_{AC}, 240 V_{AC}, and 380 V_{AC} lines to control resistive, inductive, or capacitive loads including motors, solenoids, high current thyristors or TRIAC and relays.

FEATURES

- High input sensitivity $I_{FT} = 2 \text{ mA}$
- 600 V, 800 V blocking voltage
- 300 mA on-state current
- High static dV/dt 10 kV/μs
- Very low leakage $< 10 \mu\text{A}$
- Isolation test voltage 5300 V_{RMS}
- Small 6-pin DIP package
- Compliant to RoHS Directive 2002/95/EC and in accordance to WEEE 2002/96/EC

RoHS
COMPLIANT

APPLICATIONS

- Solid state relays
- Industrial controls
- Office equipment
- Consumer appliances

AGENCY APPROVALS

- UL1577, file no. E52744 system code H, double protection
- CSA 93751
- DIN EN 60747-5-2 (VDE 0884)/DIN EN 60747-5-5 (pending), available with option 1

ORDERING INFORMATION

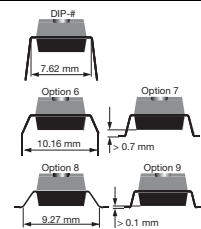
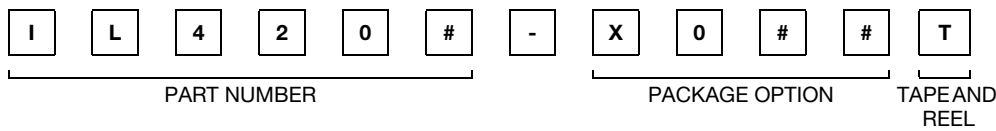

| AGENCY CERTIFIED/PACKAGE | BLOCKING VOLTAGE V_{DRM} (V) | |
|--------------------------|--------------------------------|-----------------------------|
| UL, cUL | 600 | 800 |
| DIP-6 | IL420 | IL4208 |
| DIP-6, 400 mil, option 6 | IL420-X006 | - |
| SMD-6, option 7 | IL420-X007T ⁽¹⁾ | IL4208-X007T ⁽¹⁾ |
| SMD-6, option 8 | IL420-X008T | - |
| SMD-6, option 9 | IL420-X009T ⁽¹⁾ | IL4208-X009T ⁽¹⁾ |
| VDE, UL, cUL | 600 | 800 |
| DIP-6 | IL420-X001 | - |
| DIP-6, 400 mil, option 6 | IL420-X016 | - |
| SMD-6, option 7 | IL420-X017T ⁽¹⁾ | - |

Note

⁽¹⁾ Also available in tubes, do not put T on the end.

| ABSOLUTE MAXIMUM RATINGS ($T_{amb} = 25\text{ }^{\circ}\text{C}$, unless otherwise specified) | | | | | |
|--|--|--------|------------|----------------|-----------|
| PARAMETER | TEST CONDITION | PART | SYMBOL | VALUE | UNIT |
| INPUT | | | | | |
| Reverse voltage | | | V_R | 6 | V |
| Forward current | | | I_F | 60 | mA |
| Surge current | | | I_{FSM} | 2.5 | A |
| Power dissipation | | | P_{diss} | 100 | mW |
| Derate from 25 °C | | | | 1.33 | mW/°C |
| OUTPUT | | | | | |
| Peak off-state voltage | | IL420 | V_{DRM} | 600 | V |
| | | IL4208 | V_{DRM} | 800 | V |
| RMS on-state current | | | I_{TM} | 300 | mA |
| Single cycle surge current | | | I_{TSM} | 3 | A |
| Power dissipation | | | P_{diss} | 500 | mW |
| Derate from 25 °C | | | | 6.6 | mW/°C |
| COUPLER | | | | | |
| Isolation test voltage between emitter and detector | $t = 1\text{ s}$ | | V_{ISO} | 5300 | V_{RMS} |
| Pollution degree (DIN VDE 0109) | | | | 2 | |
| Creepage distance | | | | ≥ 7 | mm |
| Clearance distance | | | | ≥ 7 | mm |
| Comparative tracking ⁽¹⁾ | | | | ≥ 175 | |
| Isolation resistance | $V_{IO} = 500\text{ V}, T_{amb} = 25\text{ }^{\circ}\text{C}$ | | R_{IO} | $\geq 10^{12}$ | Ω |
| | $V_{IO} = 500\text{ V}, T_{amb} = 100\text{ }^{\circ}\text{C}$ | | R_{IO} | $\geq 10^{11}$ | Ω |
| Storage temperature range | | | T_{stg} | - 55 to + 150 | °C |
| Ambient temperature range | | | T_{amb} | - 55 to + 100 | °C |
| Soldering temperature ⁽²⁾ | max. $\leq 10\text{ s}$ dip soldering $\geq 0.5\text{ mm}$ from case bottom | | T_{sld} | 260 | °C |

Notes

- Stresses in excess of the absolute maximum ratings can cause permanent damage to the device. Functional operation of the device is not implied at these or any other conditions in excess of those given in the operational sections of this document. Exposure to absolute maximum ratings for extended periods of the time can adversely affect reliability.

⁽¹⁾ Index per DIN IEC60112/VDE 0303 part 1, group IIIa per DIN VDE 6110.

⁽²⁾ Refer to reflow profile for soldering conditions for surface mounted devices (SMD). Refer to wave profile for soldering conditions for through hole devices (DIP).



Optocoupler, Phototriac Output, Vishay Semiconductors
High dV/dt, Low Input Current

| ELECTRICAL CHARACTERISTICS (T _{amb} = 25 °C, unless otherwise specified) | | | | | | | |
|---|--|------|-----------------------------------|--------------------|------|------|-------|
| PARAMETER | TEST CONDITION | PART | SYMBOL | MIN. | TYP. | MAX. | UNIT |
| INPUT | | | | | | | |
| Forward voltage | I _F = 10 mA | | V _F | | 1.16 | 1.35 | V |
| Reverse current | V _R = 6 V | | I _R | | 0.1 | 10 | μA |
| Input capacitance | V _F = 0 V, f = 1 MHz | | C _{IN} | | 40 | | pF |
| Thermal resistance, junction to ambient | | | R _{thja} | | 750 | | °C/W |
| OUTPUT | | | | | | | |
| Off-state current | V _D = V _{DRM} , T _{amb} = 100 °C | | I _{DRM} | | 10 | 100 | μA |
| On-state voltage | I _T = 300 mA | | V _{TM} | | 1.7 | 3 | V |
| Surge (non-repetitive), on-state current | f = 50 Hz | | I _{TSM} | | | 3 | A |
| Holding current | | | I _H | | 65 | 500 | μA |
| Latching current | V _T = 2.2 V | | I _L | | | 500 | μA |
| LED trigger current | V _D = 5 V | | I _{FT} | | 1 | 2 | mA |
| Trigger current temperature gradient | | | ΔI _{FT} /ΔT _j | | 7 | 14 | μA/°C |
| Critical rate of rise off-state voltage | V _D = 0.67 V _{DRM} , T _j = 25 °C | | dV/dt _{cr} | 10 000 | | | V/μs |
| | V _D = 0.67 V _{DRM} , T _j = 80 °C | | dV/dt _{cr} | 5000 | | | V/μs |
| Critical rate of rise of voltage at current commutation | V _D = 230 V _{RMS} , I _D = 300 mA _{RMS} , T _J = 25 °C | | dV/dt _{crq} | | 8 | | V/μs |
| | V _D = 230 V _{RMS} , I _D = 300 mA _{RMS} , T _J = 85 °C | | dV/dt _{crq} | | 7 | | V/μs |
| Critical rate of rise of on-state current commutation | | | dI/dt _{crq} | | 12 | | A/ms |
| Thermal resistance, junction to ambient | | | R _{thja} | | 150 | | °C/W |
| COUPLER | | | | | | | |
| Critical rate of rise of coupled input/output voltage | I _T = 0 A, V _{RM} = V _{DM} = V _{DRM} | | dV/dt | | 5000 | | V/μs |
| Capacitance (input to output) | f = 1 MHz, V _{IO} = 0 V | | C _{IO} | | 0.8 | | pF |
| Isolation resistance | V _{IO} = 500 V, T _{amb} = 25 °C | | R _{IO} | ≥ 10 ¹² | | | Ω |
| | V _{IO} = 500 V, T _{amb} = 100 °C | | R _{IO} | ≥ 10 ¹¹ | | | Ω |

Note

- Minimum and maximum values are testing requirements. Typical values are characteristics of the device and are the result of engineering evaluation. Typical values are for information only and are not part of the testing requirements.

| SWITCHING CHARACTERISTICS (T _{amb} = 25 °C, unless otherwise specified) | | | | | | |
|--|--|-----------------|------|------|------|------|
| PARAMETER | TEST CONDITION | SYMBOL | MIN. | TYP. | MAX. | UNIT |
| Turn-on time | V _{RM} = V _{DM} = V _{DRM} | t _{on} | | 35 | | μs |

| SAFETY AND INSULATION RATINGS ($T_{amb} = 25\text{ }^{\circ}\text{C}$, unless otherwise specified) | | | | | | |
|--|-----------------|--------|------|-----------|------|--------------------|
| PARAMETER | TEST CONDITION | SYMBOL | MIN. | TYP. | MAX. | UNIT |
| Climatic classification (according to IEC68 part 1) | | | | 55/100/21 | | |
| Comparative tracking index | | CTI | 175 | | 399 | |
| V_{IOTM} | | | 8000 | | | V |
| V_{IORM} | | | 630 | | | V |
| P_{SO} | | | | | 500 | mW |
| I_{SI} | | | | | 250 | mA |
| T_{SI} | | | | | 175 | $^{\circ}\text{C}$ |
| Creepage distance | Standard DIP-8 | | 7 | | | mm |
| Clearance distance | Standard DIP-8 | | 7 | | | mm |
| Creepage distance | 400 mil DIP-8 | | 8 | | | mm |
| Clearance distance | 400 mil DIP-8 | | 8 | | | mm |
| Insulation thickness | For IL4208 only | | 0.4 | | | mm |

Note

- As per IEC60747-5-2, § 7.4.3.8.1, this optocoupler is suitable for “safe electrical insulation” only within the safety ratings. Compliance with the safety ratings shall be ensured by means of protective circuits.

TYPICAL CHARACTERISTICS ($T_{amb} = 25\text{ }^{\circ}\text{C}$, unless otherwise specified)

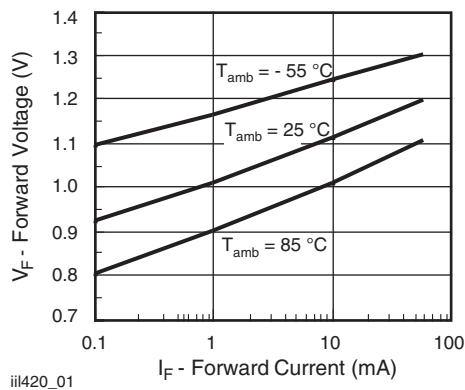

Fig. 1 - Forward Voltage vs. Forward Current

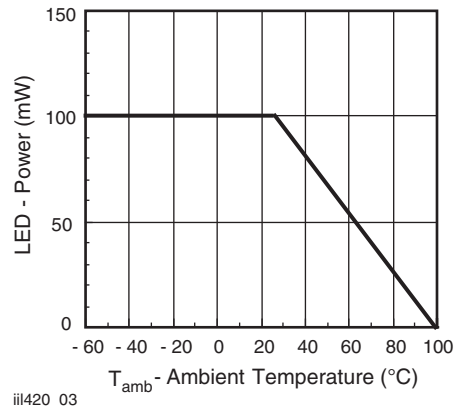

Fig. 3 - Maximum LED Power Dissipation

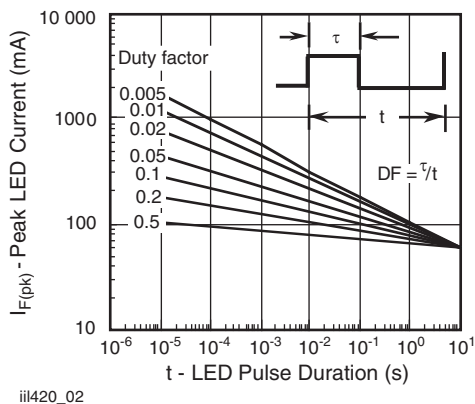

Fig. 2 - Peak LED Current vs. Duty Factor, τ

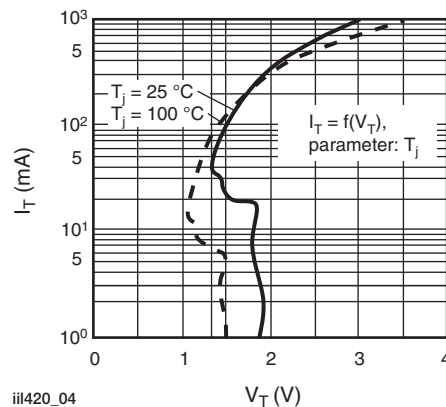
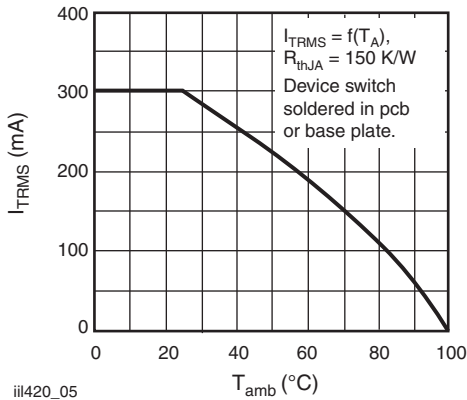
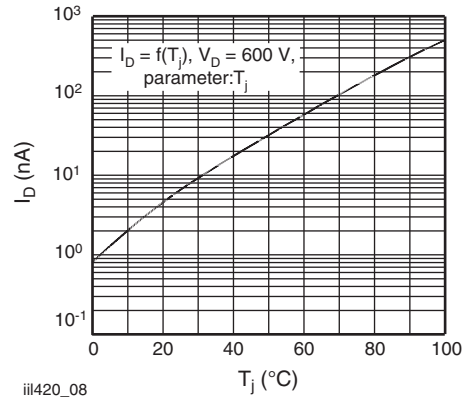
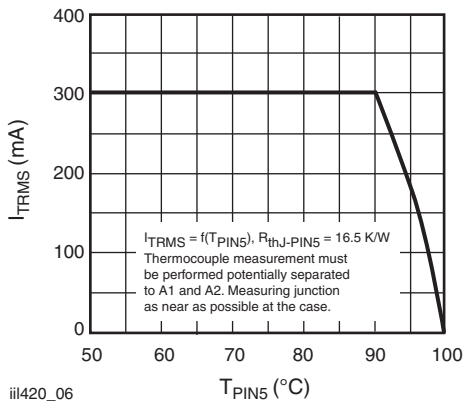
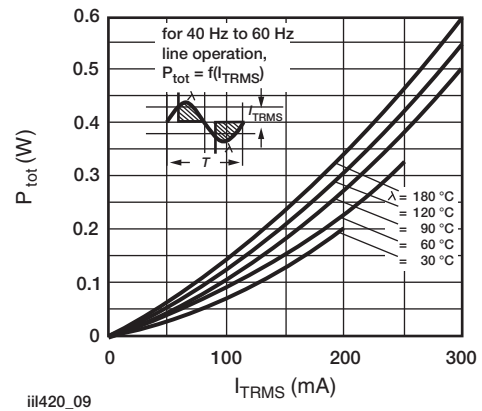
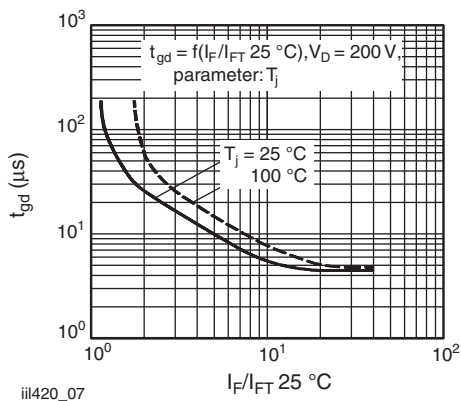
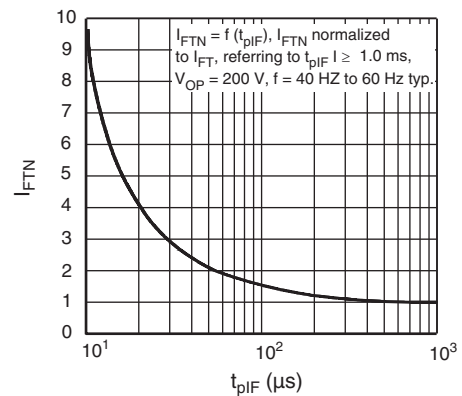

Fig. 4 - Typical Output Characteristics

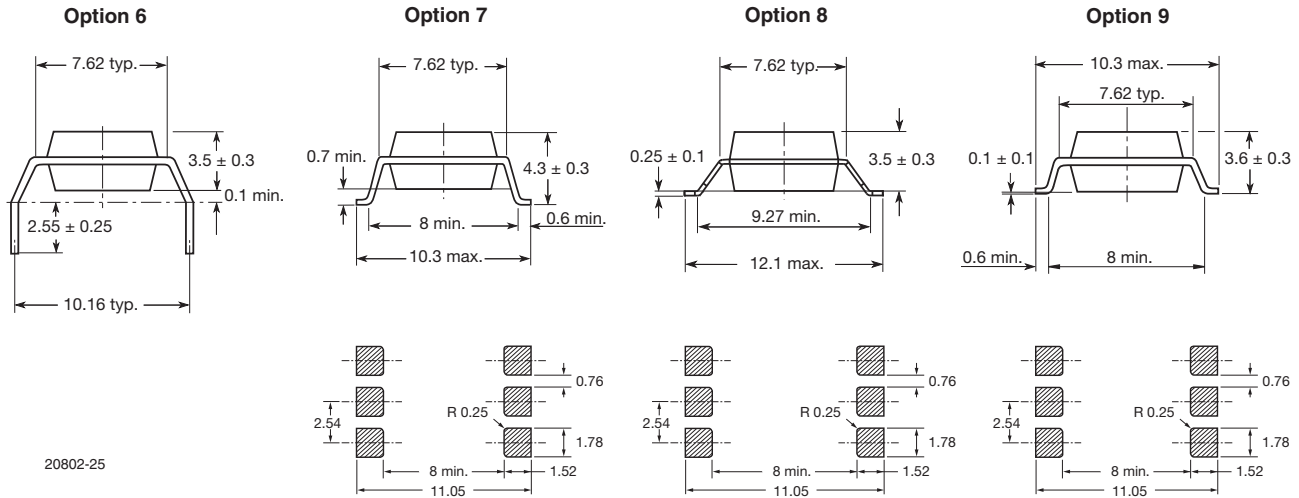
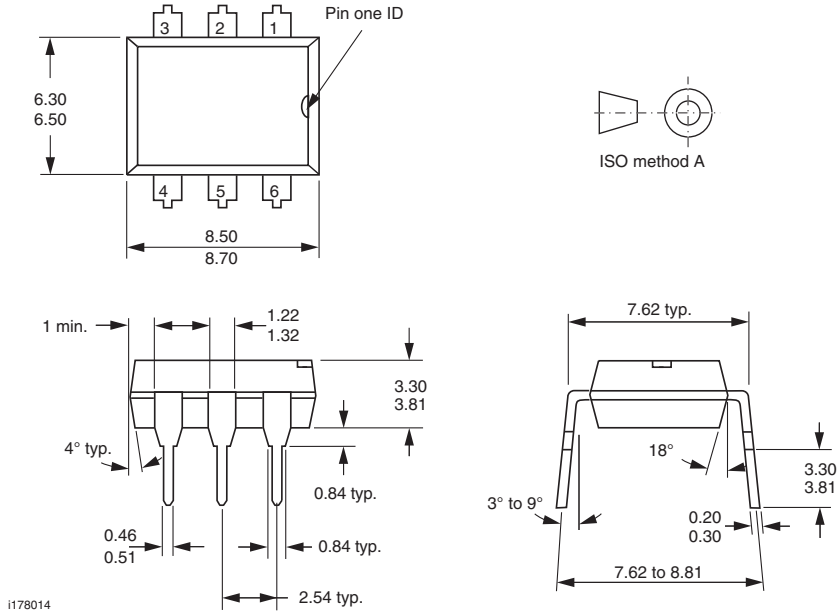

Fig. 5 - Current Reduction

Fig. 8 - Typical Off-State Current

Fig. 6 - Current Reduction

Fig. 9 - Power Dissipation

Fig. 7 - Typical Trigger Delay Time

Fig. 10 - Pulse Trigger Current

IL420, IL4208



Vishay Semiconductors Optocoupler, Phototriac Output,
High dV/dt, Low Input Current

PACKAGE DIMENSIONS in millimeters



PACKAGE MARKING (example)



Notes

- Only options 1, 7, and 8 are reflected in the package marking.
- The VDE Logo is only marked on option 1 parts.
- Tape and reel suffix (T) is not part of the package marking.



Disclaimer

ALL PRODUCT, PRODUCT SPECIFICATIONS AND DATA ARE SUBJECT TO CHANGE WITHOUT NOTICE TO IMPROVE RELIABILITY, FUNCTION OR DESIGN OR OTHERWISE.

Vishay Intertechnology, Inc., its affiliates, agents, and employees, and all persons acting on its or their behalf (collectively, "Vishay"), disclaim any and all liability for any errors, inaccuracies or incompleteness contained in any datasheet or in any other disclosure relating to any product.

Vishay makes no warranty, representation or guarantee regarding the suitability of the products for any particular purpose or the continuing production of any product. To the maximum extent permitted by applicable law, Vishay disclaims (i) any and all liability arising out of the application or use of any product, (ii) any and all liability, including without limitation special, consequential or incidental damages, and (iii) any and all implied warranties, including warranties of fitness for particular purpose, non-infringement and merchantability.

Statements regarding the suitability of products for certain types of applications are based on Vishay's knowledge of typical requirements that are often placed on Vishay products in generic applications. Such statements are not binding statements about the suitability of products for a particular application. It is the customer's responsibility to validate that a particular product with the properties described in the product specification is suitable for use in a particular application. Parameters provided in datasheets and/or specifications may vary in different applications and performance may vary over time. All operating parameters, including typical parameters, must be validated for each customer application by the customer's technical experts. Product specifications do not expand or otherwise modify Vishay's terms and conditions of purchase, including but not limited to the warranty expressed therein.

Except as expressly indicated in writing, Vishay products are not designed for use in medical, life-saving, or life-sustaining applications or for any other application in which the failure of the Vishay product could result in personal injury or death. Customers using or selling Vishay products not expressly indicated for use in such applications do so at their own risk and agree to fully indemnify and hold Vishay and its distributors harmless from and against any and all claims, liabilities, expenses and damages arising or resulting in connection with such use or sale, including attorneys fees, even if such claim alleges that Vishay or its distributor was negligent regarding the design or manufacture of the part. Please contact authorized Vishay personnel to obtain written terms and conditions regarding products designed for such applications.

No license, express or implied, by estoppel or otherwise, to any intellectual property rights is granted by this document or by any conduct of Vishay. Product names and markings noted herein may be trademarks of their respective owners.

Material Category Policy

Vishay Intertechnology, Inc. hereby certifies that all its products that are identified as RoHS-Compliant fulfill the definitions and restrictions defined under Directive 2011/65/EU of The European Parliament and of the Council of June 8, 2011 on the restriction of the use of certain hazardous substances in electrical and electronic equipment (EEE) - recast, unless otherwise specified as non-compliant.

Please note that some Vishay documentation may still make reference to RoHS Directive 2002/95/EC. We confirm that all the products identified as being compliant to Directive 2002/95/EC conform to Directive 2011/65/EU.

Компания «Океан Электроники» предлагает заключение долгосрочных отношений при поставках импортных электронных компонентов на взаимовыгодных условиях!

Наши преимущества:

- Поставка оригинальных импортных электронных компонентов напрямую с производств Америки, Европы и Азии, а так же с крупнейших складов мира;
- Широкая линейка поставок активных и пассивных импортных электронных компонентов (более 30 млн. наименований);
- Поставка сложных, дефицитных, либо снятых с производства позиций;
- Оперативные сроки поставки под заказ (от 5 рабочих дней);
- Экспресс доставка в любую точку России;
- Помощь Конструкторского Отдела и консультации квалифицированных инженеров;
- Техническая поддержка проекта, помощь в подборе аналогов, поставка прототипов;
- Поставка электронных компонентов под контролем ВП;
- Система менеджмента качества сертифицирована по Международному стандарту ISO 9001;
- При необходимости вся продукция военного и аэрокосмического назначения проходит испытания и сертификацию в лаборатории (по согласованию с заказчиком);
- Поставка специализированных компонентов военного и аэрокосмического уровня качества (Xilinx, Altera, Analog Devices, Intersil, Interpoint, Microsemi, Actel, Aeroflex, Peregrine, VPT, Syfer, Eurofarad, Texas Instruments, MS Kennedy, Miteq, Cobham, E2V, MA-COM, Hittite, Mini-Circuits, General Dynamics и др.);

Компания «Океан Электроники» является официальным дистрибьютором и эксклюзивным представителем в России одного из крупнейших производителей разъемов военного и аэрокосмического назначения «**JONHON**», а так же официальным дистрибьютором и эксклюзивным представителем в России производителя высокотехнологичных и надежных решений для передачи СВЧ сигналов «**FORSTAR**».



JONHON

«**JONHON**» (основан в 1970 г.)

Разъемы специального, военного и аэрокосмического назначения:

(Применяются в военной, авиационной, аэрокосмической, морской, железнодорожной, горно- и нефтедобывающей отраслях промышленности)

«**FORSTAR**» (основан в 1998 г.)

ВЧ соединители, коаксиальные кабели,
кабельные сборки и микроволновые компоненты:

(Применяются в телекоммуникациях гражданского и специального назначения, в средствах связи, РЛС, а так же военной, авиационной и аэрокосмической отраслях промышленности).



Телефон: 8 (812) 309-75-97 (многоканальный)

Факс: 8 (812) 320-03-32

Электронная почта: ocean@oceanchips.ru

Web: <http://oceanchips.ru/>

Адрес: 198099, г. Санкт-Петербург, ул. Калинина, д. 2, корп. 4, лит. А