

Other parameters to be aware of:	
Component Size	Temperature Coefficient
Power Rating Required	Resistance Tolerance
Pin Configuration	Current Rating
Voltage Rating	Ohmic Value Range

Precision Resistors

Product Overview

The well established Holsworthy (Holco) range of precision resistors encompasses technology in Thin Film (Metal Film), Wirewound and Thick Film technologies. Products are available in both surface mount and leaded styles ranging from small 0402 size chip resistors to 14 watt leaded devices, thereby combining precision technologies and requirements for power in a range of products.

Additionally many of these products are offered with low MOQ's making these products available to a very wide range of customers.

- Surface mount products down to 0402 size
- Tolerances to 0.01%, TCR to 5ppm
- Standard range high precision surface mount at 0.1% 10ppm available from catalogue distribution
- Some products released to BS CECC specifications
- Small quantities available on many parts
- "Holco" leaded resistors (H8, H4, H4P) can also be offered with tolerance and TCR matching of resistors in sets
- Wirewound precision available up to 14 watt power rating

Value Range	Max Power	Lowest TCR	Tightest Tolerance	Family	Page
5R11 - 470K	0.125W	5ppm	0.01%	RN73	6-7
5R1 - 5M0	0.25W	10ppm	0.1%	RP73	8-9
4R7 - 1M0	0.125W	15ppm	0.1%	CPF	10-11
10R - 4M7	0.125W	50ppm	0.5%	CPG	12-13
1R - 2M0	0.5W	10ppm	0.005%	SU	14-15
10R - 330K	0.063W	25ppm	0.10%	MRS	16
1R0 - 4M0	1W	5ppm	0.05%	Holco	17-19
4M0 - 10M	1W	25ppm	0.10%	H2	20
10R - 1M0	0.5W	15ppm	0.10%	R	21
R10 - 275K	14W	20ppm	0.01%	KC	22
R10 - 2M0	0.5W	5ppm	0.005%	UPW	23

Type RN73 Series

Type RN73 Series

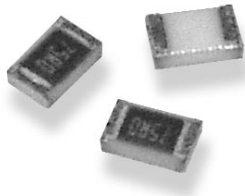

The RN73 Resistor Series is a high stability precision chip resistor range offering various power dissipations relating to chip size, TCR's down to 5ppm/°C and resistance tolerances to 0.1%. The resistor is produced with three sputtered layers giving optimum performance. Values are restricted to the E96 and E24 value grids. The RN73 Resistor has accurate and uniform physical dimensions to facilitate placement.

Key Features

- High Precision - TCR 5ppm/°C and 10ppm/°C
- Tolerance of 0.1%
- Thin Film (Nichrome)
- Choice of Packages (0805 STD)
- Stable High Frequency Performance
- 100V DC Operating Voltage
- Temperature Range -55°C to +125°C

Characteristics - Electrical

	0402 (1E)	0603 (1J)	0805 (2A)	1206 (2B)
Rated Power:	0.063W	0.063W	0.1W	0.125W
Maximum Working Voltage:	25V	50V	100V	150V
Maximum Overload Voltage:	50V	100V	200V	300V
Working Temperature Range:	-55°C ~ +125°C			
Rated Ambient Temperature:	70°C			

Resistance Value Range

Package Size	Package Code	T.C.R. (ppm/°C)	Resistance Range E-24, E-96 series
0402	1E	C (±10)	47R - 100K
0603	1J	C (±10)	10R - 270K *
0805	2A	A (±5)	10R - 150K
0805	2A	C (±10)	5R11 - 470K *
1206	2B	A (±5)	5R11 - 470K
1206	2B	C (±10)	5R11 - 470K *

Tolerances greater than 0.1% previously supplied under the RN73 Series, are now branded CPF. Please request the CPF Series datasheet.

TCR's greater than 10ppm previously supplied under the RN73 Series, are now branded CPF. Please request the CPF Series datasheet.

* Limited value range available in non RoHS compliant version

Power Derating Curve

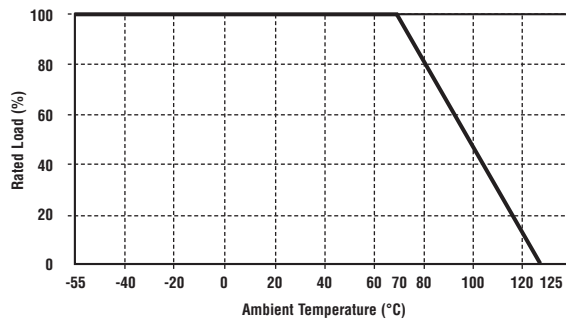

For temperatures in excess of 70°C the load shall be derated in accordance with this curve.

Type RN73 Series (continued)

Dimensions

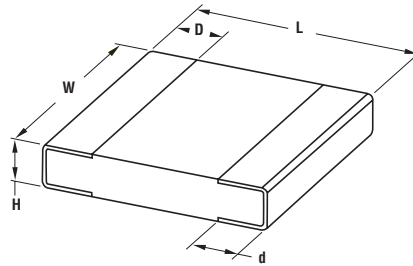

Type	L ±0.2	W ±0.2	D	d ± ^{0.2} / _{0.1}	H ± 0.1
RN73 1E	1.0	0.5	0.2	0.2	0.35
RN73 1J	1.6	0.8	0.3 ± 0.2	0.3	0.4
RN73A*	2.0	1.25	0.4 ± 0.2	0.3	0.5
RN73B	3.2	1.6	0.5 ± 0.3	0.4	0.6

How to Order

RN73	C	2A	100K	B	TDF
Common Part	Temp. Coefficient	Chip Size	Resistance Value	Tolerance	Pack Quantity
RN73 - High Precision Resistors (RoHS Compliant) NR73 - High Precision Resistors (Non RoHS Compliant)	A - ±5ppm/°C C - ±10ppm/°C	1E - 04:02 1J - 06:03 *2A - 08:05 2B - 12:06 *Preferred Stock Item	100 ohms (100 ohms) 100R 1 K ohm (1000 ohms) 1K0 100 K ohm (100000 ohms) 100K	B ±0.1%	TG - Cut Tape Lengths (1J, 2A only) TDF - 1000 (Paper) (2A only) TD - 5000 (Plastic)

Type RP73 Series

Type RP73 Series

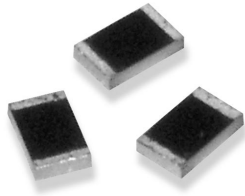

The RP73 Resistor Series is a stable thin film chip resistor range offering various power dissipation relating to chip size. The resistor is produced with three print layers for longer life and optimum performance. Values are restricted to E96 and the RP73 Resistor has accurate and uniform physical dimensions to reduce placement problems. The range is constantly being extended. Due to special technology used to produce tight tolerance, low TCR at high values the RP73 Resistor is not individually part marked.

Key Features

- High Precision - TCR 10ppm/°C
- Tolerance Down to 0.05%
- Wider Resistance Value Options
- Supplied on Reels of 1000 or 5000
- Thin Film (Nichrome)
- Stable High Frequency Performance
- 200 V DC Operating Voltage
- Temperature -55°C to +155°C

Characteristics - Electrical

Type	T.C.R's Available per Resistance Value (ppm/°C)				
	5R1 - 10R	10R1 - 47R	47R1 - 332K	332K1 - 1M0	1M1 - 5M
RP73 1J	-	25/50	10/15/25/50	-	-
RP73 2A	-	25/50	10/15/25/50	10/15/25/50	-
RP73 2B	50	25/50	10/15/25/50	10/15/25/50	50

Type	Tolerances Available per Resistance Value (%)				
	5R1 - 10R	10R1 - 100R	101R1 - 332K	332K1 - 1M0	1M1 - 5M
RP73 1J	-	0.1/0.25/0.5/1.0	0.1/0.25/0.5/1.0	-	-
RP73 2A	-	0.1/0.25/0.5/1.0	0.05/0.1/0.25/0.5/1.0	0.1/0.25/0.5/1.0	-
RP73 2B	1.0	0.1/0.25/0.5/1.0	0.05/0.1/0.25/0.5/1.0	0.1/0.25/0.5/1.0	0.25/0.5/1.0

Type	Power Rating @ 70°C	Max. Working Voltage
RP73 1J	0.065 W	30V
RP73 2A	0.125 W	75V
RP73 2B	0.250 W	200V

Long Term Stability	100R - 100K	<100R1, 100K+
Storage 125°C/1000Hrs	<0.15%	<0.35%
Storage 155°C/1000Hrs	<0.35%	<0.50%
Load P70/70°C/1000Hrs	<0.15%	<0.50%
Damp Heat (56d/40°C/96%)	<0.50%	<0.75%

Power Derating Curve

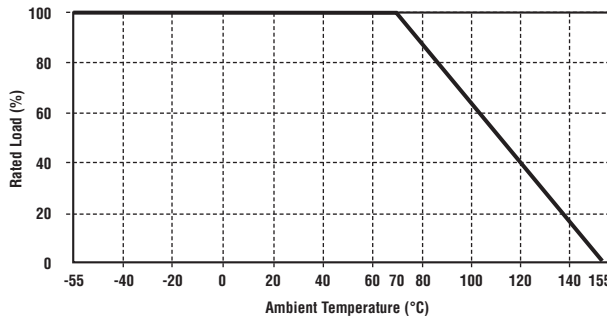

For resistors operated in ambient temperatures above 70°C, power rating must be derated in accordance with this curve.

Type RP73 Series (continued)

Dimensions

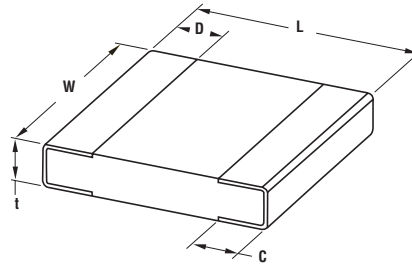

Part Number	L ±0.2	W	C	D	t ±0.1
RP73 1J	1.6	0.8±0.1	0.3±0.1	0.3 ± 0.1	0.4
RP73 2A	2.0	1.25±0.2	0.4±0.2	0.3 ± 0.2	0.4
RP73 2B	3.2	1.6±0.2	0.5±0.2	0.4 ± 0.2	0.6

Solderability - 235°C 2 seconds
 DIN IEC 68T2 - 20 Ta Meth. 1
 Max Soldering Temperature - 260°C 10 seconds
 DIN IEC 68 T2 - 20, Tb Meth. 1A

Handling Recommendations

When flow soldering - the land width must be smaller than the chip resistor width to properly control the solder application. Generally, the land width can be chip resistor width (W) x 0.7 to 0.8. When reflow soldering - solder application amount can be adjusted. Thus the land width can be set to W x 1.0 to 1.3.

How to Order

RP73	C	2A	1K0	B	TN
Common Part	Temp. Coefficient	Package Size	Resistor Value	Tolerance	Packaging
RP73 - Standard Part	C - 10ppm/°C D - 15ppm/°C F - 25ppm/°C G - 50ppm/°C	1J - 06:03 2A - 08:05 2B - 12:06	10 Ohm (10 ohms) 10R 1K Ohm (1000 ohms) 1K0 1 Meg Ohm (1000000 ohms) 1M0	B - 0.1% C - 0.25% D - 0.5% F - 1%	TN - 1000 TD - 5000

Precision Resistors

Type CPF Series

Type CPF Series

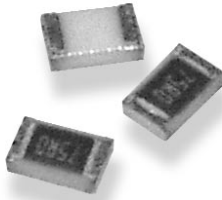

Precision metal terminations are screen printed onto a ceramic base and fired. The resistive element is sputtered and fired and the passivation layer added. The pre-scribed tile is broken into strips, the end plating is fired on and the strips broken into individual components. Final termination is made by electroplating.

Characteristics - Electrical

	0603			0805			1206		
Rated Power @ 70 °C (W)	0.063			0.1			0.125		
Resistance Range (Ohms) Min	100	10	100	100	10	100	49.9	10	10
Max	332K	97R6	360K	1M0	97R6	1M0	1M0	1M0	1M0
Tolerance (%)	0.1	0.5		0.1	0.5		0.1	0.5	
Code letter	B	D		B	D		B	D	
Selection Series	E24 - E96								
Temperature Coefficient (ppm/°C)	-25	-50	-25	-25	-50	-25	-25	-50	-50
Code Letter	E	C	E	E	C	E	E	C	C
Limiting Element Voltage (V)	60			100			150		
Maximum Overload Voltage (V)	120			200			300		
Operating Temperature Range (°C)	-55 to +125								
Climatic Category (°C)	55/125/56								
Insulation Resistance Dry Min (Mohms)	10000								
Stability (%)	0.5								

Key Features

- Thin film precision resistors with TC's of 25 and 50ppm and tolerances to 0.1%. Applications in measurement, telemetry and for sensing circuits.
- Case sizes 0603, 0805, 1206
- CPF chip resistors are suitable for all applications where close accuracy and stability are essential

Power Derating Curve

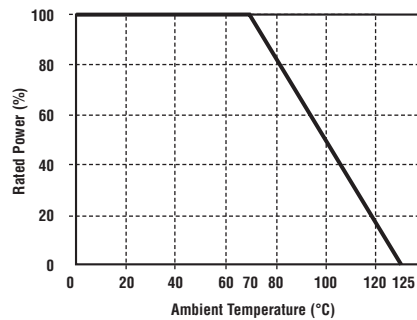

Dimensions

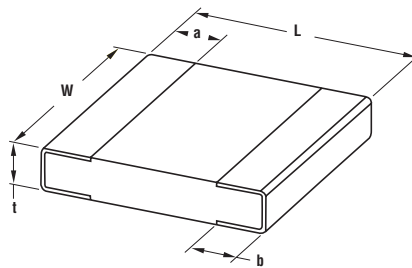

Style	L	W	t	a	b
0603	1.6 ± 0.1	0.8 ± 0.1	0.45 ± 0.1	0.25 ± 0.1	0.2 ± 0.1
0805	2.0 ± 0.2	1.25 ± 0.2	0.5 ± 0.1	0.4 ± 0.2	0.3 ± 0.2
1206	3.1 ± 0.2	1.55 ± 0.2	0.55 ± 0.1	0.45 ± 0.2	0.3 ± 0.2

Type CPF Series (continued)

Marking

E24 series resistors are marked with a three digit code.
E96 series resistors are marked with a four digit code.
0603 E96 series are unmarked.

Mounting

The resistors are suitable for processing on automatic insertion equipment.

Performance Characteristics

The evaluation of the performance characteristics is carried out with reference to IECQ specifications QC 400 000 and QC 400 100.

TEST REF	Long Term Tests $\pm(0.5\% + 0.05 \text{ ohm})$
4.23	Climatic sequence
4.24	Damp heat, steady state
4.25.1	Endurance at 70 °C
4.25.3	Endurance at 125 °C
TEST REF	Short Term Tests $\pm(0.5\% + 0.05 \text{ ohm})$
4.13	Overload
4.32	Adhesion
4.33	Bond strength of end face plating
4.19	Rapid change of temperature
4.18	Resistance to soldering heat

Storage

Unopened reels should be stored within a temperature range of +5°C to +25°C, separated from any dust, chemicals and solvent based materials. Non-adherence to this procedure could affect the solderability of this product.

How to Order

CPF	0603	B	1K13	E
Common Part	Package Size	Tolerance	Value	TCR
CPF - Chip Precision Film Resistor	0603 0805 1206	B - 0.1% D - 0.5%	100 ohms (100 ohms) 100R 1 K ohm (1000 ohms) 1K0 100 K ohm (100000 ohms) 100K	E - 25ppm C - 50ppm

Type CPG Series

Type CPG Series

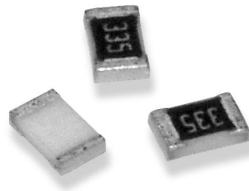

Precious metal terminations are screen printed onto a ceramic base and fired. The resistive element is screen printed and fired and the passivation layer added. Each resistor is trimmed to tolerance by laser. The pre-scribed tile is broken into strips, the end plating is fired on and the strips broken into individual components. Final termination is made by electroplating.

Characteristics - Electrical

	0603				0805		1206			
Rated Power @ 70°C (W)	0.063				0.1		0.125			
Resistance Range (Ohms)	Min	100	10	100	1M1	10	10	10	10	
	Max	1M1	91	1M0	3M3	3M3	3M3	4M7	4M7	
Tolerance (%)	0.5				1		0.5		1	
Code letter	D				F		D		F	
Selection Series	E24 - E96									
Temperature Coefficient (ppm/°C)	-50	-100	-50	-100	-50	-50	-50	-50		
Code Letter	C	D	C	D	C	C	C	C		
Limiting Element Voltage (V)	50				150		200			
Maximum Overload Voltage (V)	100				300		400			
Dielectric Strength Min (V)	100				300		400			
Operating Temperature Range (°C)	-55 to +125									
Climatic Category	55/125/56									
Insulation Resistance Dry Min (Mohms)	1000									
Stability (%)	0.5									
Surface Temperature Rise Max (°C)	400									

Key Features

- Case sizes 0603, 0805, 1206
- A semi-precision thick film resistor with a temperature coefficient of 50ppm/°C and tolerance down to 0.5%.
- CPG chip resistors are suitable for most applications, including high frequency operation, owing to the short lead structure and low capacitance.
- Particularly suitable for use where low TC or tolerance are important at a low cost.

Power Derating Curve

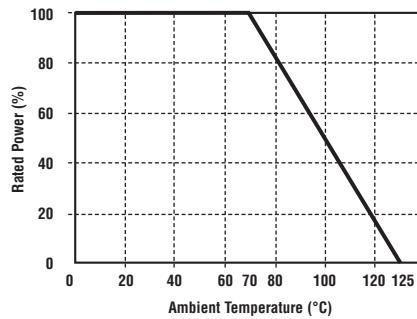

Dimensions

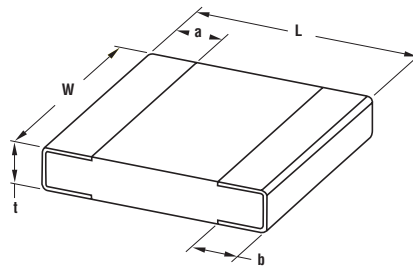

Style	L	W	t	a	b
0603	1.6 ± 0.1	0.85 ± 0.1	0.45 ± 0.1	0.25 ± 0.1	0.3 ± 0.1
0805	2.0 ± 0.1	1.25 ± 0.1	0.6 ± 0.1	0.4 ± 0.2	0.4 ± 0.2
1206	3.2 ± 0.15	1.6 ± 0.15	0.66 ± 0.1	0.5 ± 0.25	0.5 ± 0.25

Type CPG Series (continued)

Marking

E24 series resistors are marked with a three digit code.
E96 series resistors are marked with a four digit code.
0603 E96 series are unmarked.

Mounting

The resistors are suitable for processing on automatic insertion equipment.

Performance Characteristics

The evaluation of the performance characteristics is carried out with reference to IECQ specifications QC 400 000 and QC 400 100.

TEST REF	Long Term Tests $\pm(0.5\% + 0.1 \text{ ohm})$
4.23	Climatic sequence
4.24	Damp heat, steady state
4.25.1	Endurance at 70°C
4.25.3	Endurance at 125°C
TEST REF	Short Term Tests $\pm(0.5\% + 0.05 \text{ ohm})$
4.13	Overload
4.32	Adhesion
4.33	Bond strength of end face plating
4.19	Rapid change of temperature
4.18	Resistance to soldering heat

Storage

Unopened reels should be stored within a temperature range of +5°C to +25°C, separated from any dust, chemicals and solvent based materials. Non-adherence to this procedure could affect the solderability of this product.

How to Order

CPG	0603	F	10R
Common Part	Size	Tolerance	Resistance Value
CPG - Thick Film Precision Chip Resistor	0603 0805 1206	F - $\pm 1\%$ D - $\pm 0.5\%$	10 ohms (10 ohms) 10R 1K ohms (1000 ohms) 1K0 100 K ohm (100000 ohms) 100K 1M ohm (1000000 ohms) 1M0

SMD Precision Resistors

Type S Series

Type S Series



Tyco Electronics Components introduces a range of surface mount power resistors to meet today's circuit design needs. One design concept allows an engineer to choose from three styles (Lo Ohm, Power, or Ultra Precision) while staying within the new standard circuit board land pattern guidelines now accepted by the wirewound resistor industry. Each size offers low profile case design with flexible tinned copper terminations for reliable solder joints. All styles utilise a fully welded construction technique, unlike other designs that rely solely on tinned termination connections. These features allow the S Series to withstand the higher temperatures associated with reflow, vapour phase, or infrared (IR) manufacturing processes without degradation.

Key Features

- Low Profile Design
- Available on Tape (3 Reel Sizes)
- Very Wide Value Range
- Ideal for Current Sensing
- Up to 3.0 Watts Power
- High TCR Versions (to 6000ppm)
- Stable to 5ppm/°C

Characteristics - Electrical

	"SP" Power	"SU" Precision
Values S1/2:	R06 - 1K4	----
Values S1:	R10 - 5K0	1R0 - 300K
Values S2:	R10 - 10K	1R0 - 1 Meg
Values S3:	R10 - 45K	1R0 - 2 Meg
Grid:	E96	E192
Resistance Tolerances:	0.1% to 5%.	0.005% to 1%.
Power Rating @ 25°C S1/2:	0.75 Watts	----
Power Rating @ 25°C S1:	1.5 Watt	0.125 Watts
Power Rating @ 25°C S2:	2.5 Watts	0.250 Watts
Power Rating @ 25°C S3:	3.5 Watts	0.500 Watts
Derating:	See Curve Below	See Curve Below
Max. Operating Voltage S1/2:	33 Volts	----
Max Operating Voltage S1:	58 Volts	100 Volts
Max Operating Voltage S2:	127 Volts	300 Volts
Max Operating Voltage S3:	212 Volts	400 Volts

Environmental

		Typical ΔR
Solder Immersion:	260°C for 10 seconds.	0.1%
Load Life:	2000 hours at rated power at 25°C.	0.2%
Moisture Resistance:	240 hours with humidity ranging from 80% RH to 98% RH.	0.1%
Thermal Shock:	-55°C for 15 minutes no load.	0.1%
Dielectric Withstand:	1000 Volts.	
Short Term Overload:	5 times rated power for 5 seconds	0.1%
Solderability:	95% coverage within 1/16" of contact point.	----
Flammability:	UL94V Rating.	----

Temperature Coefficient of Resistance

Range	(P) Power	(U) Precision
R10 - R99	±30ppm	
1R0 - 10R	±20ppm	±25ppm
11R - 99R	±90ppm	±10ppm
100R and over	±50ppm	±10ppm

NB: High TCR Type Available to 6000ppm/°C

Power Derating

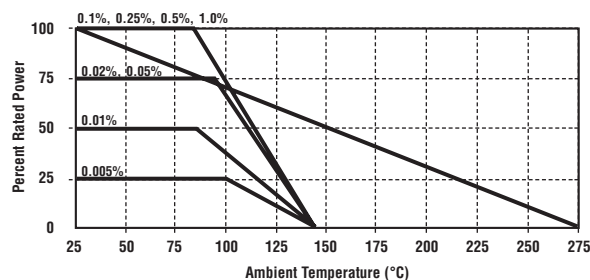

Note: U Style derates to 145°C. All others derate to 275°C

Type S Series (continued)

Dimensions

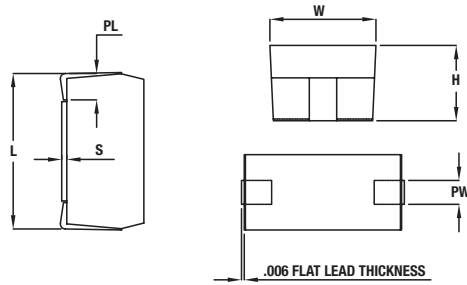

Size	Length (L)	Width (W)	Height (H)	Stand Off (S)	Pad Width (PW)	Pad Length (PL)
S 1/2	5.46	3.18	2.54	n/a	1.27	1.02
S1	6.48	3.81	2.84	0.50	1.27	1.25
S2	12.14	5.84	5.33	0.50	2.54	2.54
S3	15.24	7.00	6.48	0.50	2.29	1.27

Land Pattern

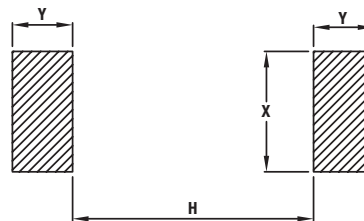

Type	H	J	X	Y
S 1/2	1.91	4.45	1.78	2.54
S1	3.43	5.97	2.03	2.54
S2	6.98	10.54	3.05	3.56
S3	10.42	14.78	2.80	3.56

Cleaning Conditions

After soldering use cleaning solvents such as chlorosol, dyefreon, suitable aqueous or semi aqueous cleaner.

Storage

To prevent damage to the electrode, be sure to observe the following cautions for storage.

- Store in 40°C maximum ambient temperature, and 70% maximum R.H.
- For maximum possible shelf life do not disturb polythene sleeve until you are ready to use.
- Store where there are no harmful gases containing sulphur or chlorine.

How to Order

S	U	1	1R0	J	T
Common Part	Resistor Type	Case Size	Resistance Value	Absolute Tol. at +25°C	Pack Style
S - Standard Part	P - Power U - Precision	1/2 - 5.5 x 3.2 1 - 6.5 x 3.8 2 - 12.1 x 5.9 3 - 15.3 x 7.0	0.1 Ohm (100 milli ohms) R10 1 Ohm (1000 milli ohms) 1R0 1K Ohm (1000 Ohms) 1K0	K ±10% J ±5% E ±3% F ±1% D ±0.5% C ±0.25% B ±0.1% A ±0.05% Q ±0.02% T ±0.01% Z ±0.005%	L - Loose Piece R - S_1 500 pcs 7" Reel S - S_1 1000 pcs 13" Reel W - S_2 1000 pcs 13" Reel

Type MRS Series

Type MRS Series

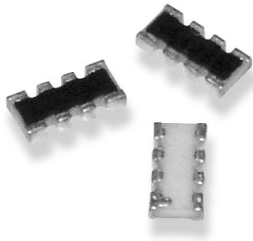

The MRS series is an entirely new chip network utilising nickel chrome sputtering on high purity alumina. This network has been designed for high volume applications and is offered with 4 isolated resistors on a single substrate (12.06 sizes) at 0.1% with convex terminals. A wide value range and alternative T.C.R's make this a most versatile resistor solution.

Key Features

- Suitable for Tight Spaces
- High Precision Thin Film
- Wide Value Range
- Lower Placement Costs
- Range of Stabilities
- Low Cost in Volume
- High Reliability Design

Characteristics - Electrical

Resistance Range:	10R ~ 91R	100R ~ 33K	36K ~ 330K
Resistance Tolerance:	±0.5%, ±1%	±0.1%, ±0.5%, ±1%	±0.5%, ±1%
Temperature Coefficient of Resistance:	±50ppm/°C	±25ppm/°C	±100ppm/°C
Rated Power (Suitable Heatsink):	63mW / element	63mW / element	63mW / element
Selection Series:	E24	E24	E24
Maximum Operating Voltage:	75V	75V	75V

Power Derating Curve

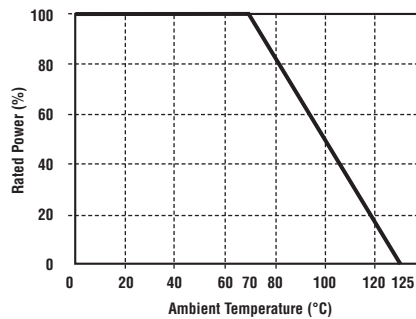

Dimensions

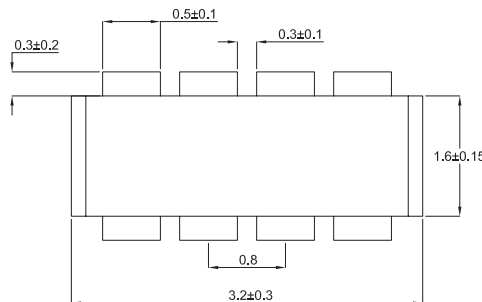

Schematic Layout

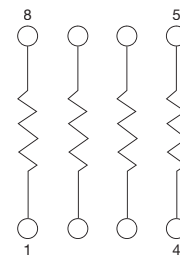

How to Order

MRS	100K	B
Common Part	Resistance Value	Tolerance
MRS - Precision Thin Film Chip Network	100 ohms (100 ohms) 100R 1K ohm (1000 Ohms) 1K0 100K ohm (100000 ohms) 100K	B ± 0.1% D ±0.5% F ± 1%

Type HOLCO Series

Type HOLCO Series



The Holco range of Precision Metal Film Resistors meets the requirement for economically priced components for industrial and military applications. The manufacturing facility utilises closely controlled production processes including the sputter coating of metal alloy films to ceramic substrates, and laser spiralling to achieve close tolerance and high stability resistors. An epoxy coating is applied for environmental and mechanical protection. Commercially the Series is available in two case sizes, from 1 ohm to 4M ohms, tolerances from 0.05% to 1% and TCR's from 5ppm/°C to 100ppm/°C. Offered with release to BS CECC 40101 004, 030 and 804 the H8 is available via distribution.

Key Features

- Ultra Precision - Down To 0.05%
- Matched Sets Available To 2ppm/°C
- High Pulse Withstand
- Low Reactance
- Low TCR - Down To 5ppm/°C
- Long Term Stability
- Up To 1 Watt At 70°C
- Released To CECC 40101 004, 030 And 804

Characteristics - Electrical

	H4P	H4	H8	
BS CECC 40101 004				
Style:		K	H	J
Power Rating at 70°C:		0.25W	0.063W	0.125W
Temperature Rise (maximum):		32°C	14°C	28°C
Limiting Element Voltage:		250V	150V	200V
BS CECC 40101 030				
Style:		J	H	
Power Rating at 125°C:		0.125W	0.1W	
Temperature Rise (maximum):		30°C	30°C	
Limiting Element Voltage:		250V	200V	
BS CECC 40101 804				
Style:		B	A	
Power Rating at 125°C:		0.25W	0.125W	
Limiting Element Voltage:		350V	350V	
Commercial Ratings				
Power Rating at 70°C:	1.0W	0.5W	0.25W	
Temperature Rise:	70°C	55°C	40°C	
Limiting Element Voltage:	500V	300V	250V	

Temperature Coefficient / Tolerance Ranges

TCR ppm/°C	H4P			H4			H8		
	0.05%	0.1%-0.25%	0.5%-1.0%	0.05%	0.1%-0.25%	0.5%-1.0%	0.05%	0.1%-0.25%	0.5%-1.0%
5	10R-500K	10R-500K	1R0-500K	10R-500K	10R-500K	1R0-500K	10R-500K	10R-500K	1R0-500K
10	10R-1M0	10R-1M0	1R0-1M0	10R-1M0	10R-1M0	1R0-1M0	10R-1M0	10R-1M0	1R0-1M0
15	10R-1M0	5R0-1M0	1R0-1M0	10R-1M0	5R0-1M0	1R0-1M0	10R-1M0	5R0-1M0	1R0-1M0
25	10R-1M0	5R0-2M0	1R0-2M0	10R-1M0	5R0-2M0	1R0-2M0	10R-1M0	5R0-2M0	1R0-2M0
50	10R-1M0	5R0-2M0	1R0-4M0	10R-1M0	5R0-2M0	1R0-4M0	10R-1M0	5R0-2M0	1R0-4M0
100	10R-1M0	1R0-2M0	1R0-4M0	10R-1M0	1R0-2M0	1R0-4M0	10R-1M0	1R0-2M0	1R0-4M0

**Approved Value Ranges
40101-004, 40101-030, 40101-804**

Type	Style 004	Style 030	Z 100ppm	C 50ppm	D 25ppm	Y 15ppm	Style 080	C 50ppm	D 25ppm	T 15ppm
H4	K	J	10R-1M0	49R9-1M0	49R9-1M0	49R9-1M0	B	49R9-1M0	49R9-1M0	49R9-1M0
H8	HJ	H	10R-1M0	10R-1M0	49R9-1M0	49R9-1M0	A	49R9-1M0	49R9-1M0	49R9-1M0

Tolerances 0.1%, 0.25%, 0.5%, 1%

Dimensions

To prevent damage to the components conformal coating, the leads should be adequately supported during the forming process

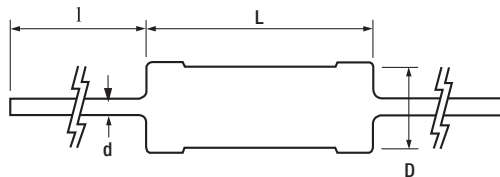

	H4P	H4	H8
Body Length (L) maximum:	10.0 mm	10.0 mm	7.20 mm
Body Diameter (D) maximum:	3.70 mm	3.70 mm	2.50 mm
Lead Diameter (d) maximum:	0.60 mm	0.60 mm	0.60 mm
Lead Length (l) nominal:	30.0 mm	30.0 mm	30.0 mm
Recommended Mounting Pitch:	12.7 mm	12.7 mm	10.2 mm
Weight (g/100 resistors)	40	40	24

Type HOLCO Series (continued)

**Characteristics -
Electrical**

	Typical Data	Reference
Voltage Coefficient of Resistance (Between 10% and Full Rated Voltage)	Less Than 5ppm/Volt Applied	n/a
Insulation Resistance at 500 Volts	Greater Than 10 ¹² Ohms	n/a
Resistance to Soldering Heat (260°C for 10 Secs.)	Less Than 0.05%	BS CECC 40101 004 Para 4.15.2
Short Term Overload (6.25 Times Rated BS CECC Wattage for 5 Seconds)	Less Than 0.06%	BS CECC 40101 004 Para 4.11
Ambient Temperature Range	-55°C to +155°C	BS CECC 40101 004, BS CECC 40101 030 & Commercial
Rapid Change of Temperature (-55°C to +155°C, 5 cycles)	Less Than 0.04%	BS CECC 40101 004 Para 4.16
Shelf Life (at Normal Room Temp.)	Less Than 0.05% Per Annum	n/a
Vibration (10-500 HZ, Amplitude 0.75mm, or Acceleration 98m/s² which is less severe, sweep duration 6 hours)	Less Than 0.04%	BS CECC 40101 004 Para 4.19
Vibration (55-2000 Hz Simple Harmonic Motion, Max. Acceleration 98m/s², Duration 35±5 Minutes)	Less Than 0.04%	MIL STD 202 METHOD 204-C
Bump (390m/s², 4000 Bumps)	Less Than 0.03%	BS 2011 Part 2.1 Eb 1977 (1984)
Load Stability	See Graphs	n/a
Damp Heat Steady State	See Graph	BS CECC 40101 004 Para 4.21

General Data

Lead Material:	Solderability to BS CECC 40101 004 Para 4.15.1
Encapsulation:	Conformal Epoxy Coating
Resistor Marking:	Legend printed in accordance with CECC 40000 Para 2.4
Solvent Resistance:	The epoxy coating and print will withstand the action of all commonly used industrial cleansing solvents

Characteristics - Long Term Stability

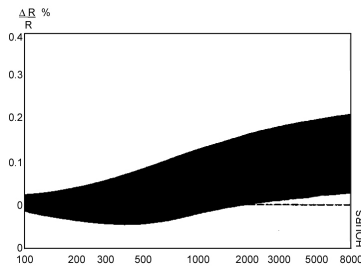

Long Term Stability
BS CECC 40101 004
Ratings at 70°C
H4 - 0.25 W
H8 - 0.125 W

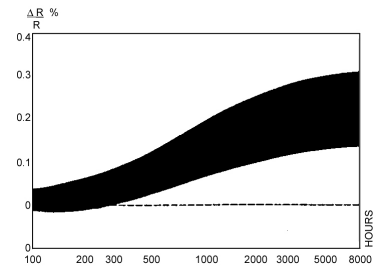

Long Term Stability
BS CECC 40101 030
Ratings at 125°C
H4 - 0.125 W
H8 - 0.1 W

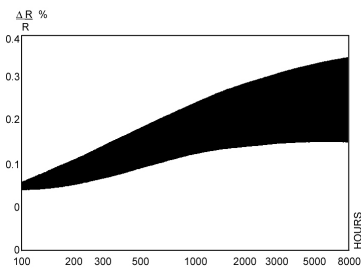

Long Term Stability
Commercial
Ratings at 125°C
H4P - 1W
H4 - 0.5 W
H8 - 0.25 W

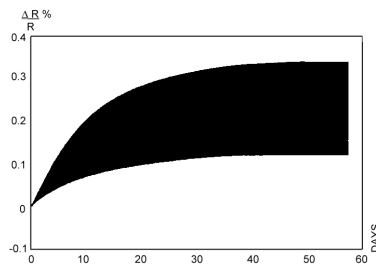

Damp Heat Steady State
93% RH at 40°C

Derating Graph - Approved and Commercial Ratings

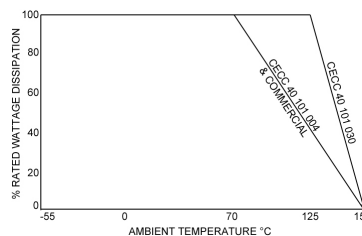

How to Order

H8	100R	B	Y	B	R
Common Part	Resistance Value	Tolerance	T.C.R. Code	Release	Factory Stock Code
H4P H4 H8	1.0 ohm (1000 milli ohms) 1R0 10 ohm (10 ohms) 10R 100 ohm (100 ohms) 100R 1K Ohm (1000 ohms) 1K0 10K ohm (10000 ohms) 10K 100K ohm (100000 ohms) 100K 1M ohm (1000000 ohms) 1M0	A - 0.05% B - 0.1% C - 0.25% D - 0.5% F - 1.0%	A - 5ppm B - 10ppm Y - 15ppm D - 25ppm C - 50ppm Z - 100ppm	A - Part can only be sold with Commercial or C of C release. B - Part can be sold to BS CECC 40101 004, BS CECC 40101 030, Commercial or C of C release. D - Part can be sold to all above approvals and BS CECC 40101 804	Batch Code

Precision Resistors

Axial Leaded Precision Resistors

Type H2 Series

Type H2 Series



The H2 range of Precision Metal Film Resistors meets the requirement for economically priced components for industrial and military applications. The manufacturing facility utilises closely controlled production processes including the sputter coating of metal alloy films to ceramic substrates, and laser spiralling to achieve close tolerance and high stability resistors. An epoxy coating is applied for environmental and mechanical protection.

Key Features

- Tolerances - Down To 0.1%
- High Pulse Withstand
- Low TCR - Down To 25ppm/°C
- Long Term Stability
- Up To 1 Watt at 70°C

Characteristics - Electrical

Power Rating at 70°C: (Derates to zero at 155°C)	1.0W
Temperature Rise:	65°C
Limiting Element Voltage:	350V

Temperature Coefficient / Tolerance Ranges

TCR ppm/°C	0.1%-0.25%	0.5%-1.0%
25	4M0-5M0	4M0-5M0
50	4M0-10M	4M0-10M
100	4M0-10M	4M0-10M

General Data

Lead Material:	Solderability to BS CECC 40101 004 Para 4.15.1
Encapsulation:	Conformal Epoxy Coating
Resistor Marking:	Legend printed in accordance with CECC 40000 Para 2.4
Solvent Resistance:	The epoxy coating and print will withstand the action of all commonly used industrial cleansing solvents

Electrical

	Typical Data
Voltage Coefficient of Resistance (Between 10% and Full Rated Voltage)	Less Than 5ppm/Volt Applied
Insulation Resistance at 500 Volts	Greater Than 10 ¹² Ohms
Resistance to Soldering Heat (260°C for 10 Secs.)	Less Than 0.05%
Short Term Overload (6.25 Times Rated BS CECC Wattage for 5 Seconds)	Less Than 0.06%
Ambient Temperature Range	-55°C to +155°C
Rapid Change of Temperature (-55°C to +155°C, 5 cycles)	Less Than 0.04%
Shelf Life (at Normal Room Temp.)	Less Than 0.05% Per Annum
Vibration (10-500 HZ, Amplitude 0.75mm, or Acceleration 98m/s² which is less severe, sweep duration 6 hours)	Less Than 0.04%
Vibration (55-2000 Hz Simple Harmonic Motion, Max. Acceleration 98m/s², Duration 35±5 Minutes)	Less Than 0.04%
Bump (390m/s², 4000 Bumps)	Less Than 0.03%

Dimensions

To prevent damage to the components conformal coating, the leads should be adequately supported during the forming process

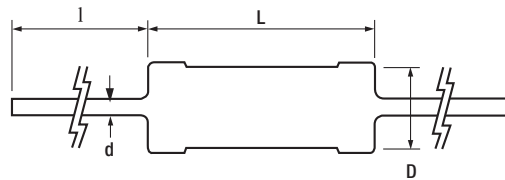

Body Length (L) maximum	Body Diameter (D) maximum	Lead Diameter (d) maximum	Lead Length (l) nominal	Recommended Mounting Pitch	Weight (g/100 resistors)
15.5 mm	5.50 mm	0.80 mm	30.0 mm	18.4 mm	115

How to Order

H2	4M0	B	D	A	R
Common Part	Resistance Value	Tolerance	T.C.R. Code	Release	Factory Stock Code
H2	4M ohm (4000000 ohms) 4M0	B - 0.1% C - 0.25% D - 0.5% F - 1.0%	D - 25ppm C - 50ppm Z - 100ppm	A - Part can only be sold with Commercial or C of C release.	Batch Code

Type R Series

Type R Series



The resistive element comprises a thin film of nickel-chrome alloy evaporated onto a high thermal conductivity ceramic element. Metal end caps are force fitted to the element prior to spiralling to value. Tinned copper lead wires are welded to the end caps and the components are then coated. One coat of phenolic resin is followed by three coats of epoxy resin. All resistors are tested for value and tolerance.

Key Features

- Precision metal film resistors with tolerance to 0.1% and temperature coefficients to 15ppm.
- Metal film resistors have excellent stability under load and severe environmental conditions. They exhibit very low noise current and voltage coefficients. Precision metal film resistors are particularly suitable in all applications where long-term stability is important.

Characteristics - Electrical

	YR8	ER8	CR8	YR1	ER1	CR1	YR2	ER2	CR2
Rated Power @ 70°C (W)	0.125			0.25			0.5		
Resistance Range (ohms) Min	51R1			10R			10R		
Max	511K			1M0			1M0		
Tolerance (%)	0.1			0.25			0.5		
Code Letter	B			C			D		
Temperature Coefficient (ppm/°C)	± 15	± 25	± 50	± 15	± 25	± 50	± 15	± 25	± 50
Selection Series	E96								
Limiting Element Voltage - Nominal (V)	200			250			350		
Maximum Overload Voltage (V)	400			500			700		
Operating Temperature Range (°C)	-65 to +155								
Dielectric Strength (V)	500								
Insulation Resistance Min Dry (Mohms)	10,000								
Voltage Coefficient Max (ppm/V)	5								

Dimensions

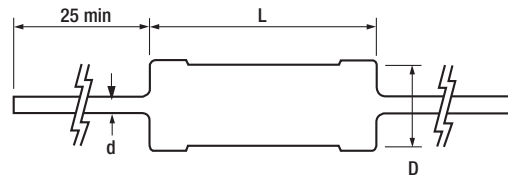

Style	L*	D	d nom	Ammo Pack
R8	3.3 ± 0.1	1.7 ± 0.2	0.45	1000
R1	6.3 ± 0.3	2.3 ± 0.2	0.6	1000
R2	9.5 ± 0.5	3.5 ± 0.5	0.6	1000

* Length is measured in accordance with IEC 294

Derating Curve

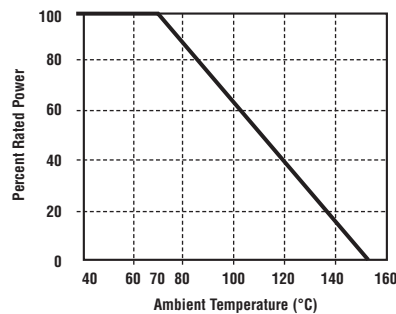

Surface Temperature Vs Load

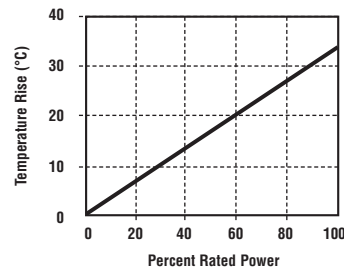

How to Order

Y	R	1	B	10R	CC
TCR	Common Part	Power Range	Tolerance	Resistance Value	Marking Code
C - 50ppm E - 25ppm Y - 15ppm	R	1 - 0.25W 2 - 0.5W 8 - 0.125W	B - 0.1% C - 0.25% D - 0.5%	10 ohm (10 ohms) 10R 1K Ohm (1000 ohms) 1K0 100K ohm (100000 ohms) 100K 1M ohm (1000000 ohms) 1M0	CC - Five Band Colour Code

Type KC Series

Type KC Series



The KC Series draws together high power and high precision in one attractively priced silicone coated package. Windings are accurately space wound on ceramic or aluminium oxide cores. Winding pitch is controlled for high winding density to obtain maximum power dissipation by transmitting more heat down the length of the core, thereby lowering the "Hot Spot" temperature. The resistance wire is welded to the end cap using the most advanced electronically controlled D.C. Welders. Where high reliability is required the resistance wire is sandwiched between a weld tab and the end cap to provide the ultimate in reliability. Coated power resistors have high resistance to commonly used solvents.

Key Features

- High Power, Precision & Reliability
- 0.5 Watts up to 14 Watts
- Ayrton Perry Windings Available
- Tolerances to 0.01%
- Low Temperature Coefficient
- 350°C Max Temperature
- Conformally Coated
- High Reliability

Characteristics - Electrical

Resistance Values:	R10 to 275K
Resistance Tolerance:	10%, 5%, 3%, 1%, (available to ± 0.01% on request)
Rated Dissipation:	0.5 watts to 14 watts
Dielectric Strength:	1KV (All Types)
Insulation Resistance:	1000 Meg Ohms
Terminal Strength:	5lb pull test
Solderability:	Meets MIL - STD - 202
Temperature Coefficient of Resistance:	±20ppm/°C - 100R and over ±30ppm/°C - 10R to 100R ±50ppm/°C - 1R0 to 10R Closer T.C.'s available. Please ask for quotation
Temperature Range:	-55°C to +355°C
Environmental Requirements:	Meets or exceeds military specifications

Style	Power Rating (W)	Working Voltage (V)	Maximum Resistance (ohms)	Dimensions			
				L ±1.7	D ±0.8	d	l
KC-1/2	1.2	73	4.5K	7.10	2.40	0.50	38.0
KC-1B	1.6	137	12K	13.50	2.40	0.50	38.0
KC-1D	4.5	406	38K	17.80	2.80	0.50	38.0
KC-2B	5.0	444	42K	20.60	4.75	0.80	38.0
KC-2C	3.5	181	32K	12.70	6.35	0.80	38.0
KC-3	5.5	295	45K	15.90	6.35	0.80	38.0
KC-5	6.0	444	90K	22.23	7.90	1.00	38.0
KC-6	6.5	488	95K	25.40	7.90	1.00	38.0
KC-7	8.0	730	100K	30.50	7.90	1.00	38.0
KC-7A	9.0	800	150K	34.90	9.50	1.00	38.0
KC-10A	12.0	1000	275K	45.21	9.50	1.00	38.0

Dimensions

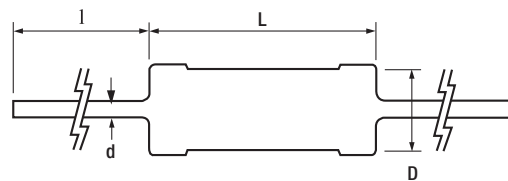

Derating Curve

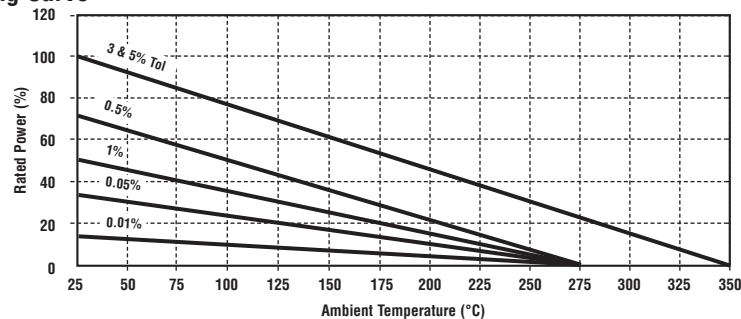

How to Order

KC	2A	2K0	J	—
Common Part	Package Style	Resistance Value	Tolerance	Packaging
KC - Standard Part NC - Low Inductive Winding	See Table Above	0.1 ohm (100 milli ohm) R10 1 ohm (1000 milli ohm) 1R0 1K ohm (1000 ohm) 1K0	K ±10% J ±5% E ±3% F ±1%	— - Bulk B - Banded

Type UPW Series

Type UPW Series



The resistive element is wire wound onto a moulded high temperature plastic bobbin with a central former. The direction of winding is reversed part way through the winding, giving very low values of inductance.

These Neohm resistors use bobbin assemblies with flattened lead ends, providing high resistance to pull, vibration and torsional forces during handling, assembly and life.

Key Features

- Custom weld tabs and copper weld leads ensure a good mechanical and electrical connection between the element and the lead wires. Protection is given to the windings by means of a layer of silicone RTV rubber. This allows movement of the windings during temperature cycling due to loads and to varying ambient temperatures. Outer protection is given by means of a hot transfer moulded epoxy compound which ensures an airtight coating with no trapped air.
- Superior quality wire-wound resistors with very low selection tolerances and temperature coefficients down to 1 ppm. 3 case sizes are available. T/C, ratio and pair matching is available and customer specifications are welcome. These components exhibit high stability under load and severe environmental conditions.
- Packed loose in boxes

Characteristics - Electrical

	UPW15	UPW25	UPW30	UPW50
Rated Power @ 125°C (W) Derate to zero at 145°C	0.125	0.25	0.3	0.5
Resistance Range (Ohms) Min	R10	R10	R10	R10
Max	300K	1M0	1M0	2M0
Tolerance (%)	0.005 0.01 0.02 0.05 0.1 0.2 0.5 1			
Code Letter	E L P W B A D F			
Limiting Element Voltage (V)	150	300	150	400
Temperature Coefficient (ppm/°C) Typ.	± 3 (0°C to +85°C)			
Max.	± 5 (-55°C to +125°C) ± 1 available on request			
Operating Temperature Range (°C)	-55 to +145			
Long Term Stability (Load)	< 50 ppm @ 10,000 hrs < 100ppm @ 26,000 hrs			
Thermal EMF	< 0.2 µ V /°C			

Dimensions
Style A

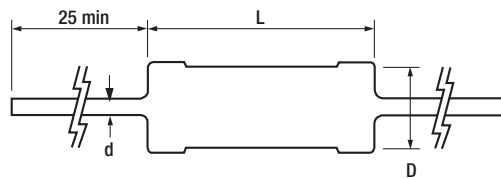

Style B

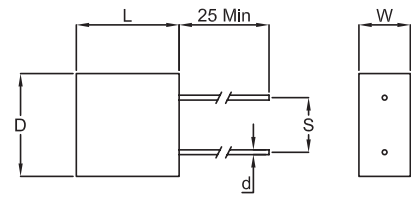

Type	Style	L ± 0.4	D ± 0.4	W ± 0.5	s ± 0.2	d nom
UPW15	A	6.35	3.18	-	-	0.64
UPW25	A	9.53	4.75	-	-	0.64
UPW30	B	7.62	7.62	3.18	3.81	0.64
UPW50	A	12.7	6.35	-	-	0.81

Derating Curve

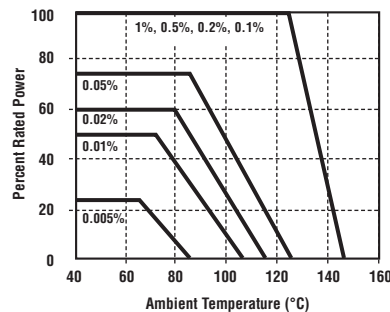

UPW Series resistors must be derated for tolerances below 0.1%. Use the graph to select tolerance versus operating temperature to determine the percentage rated power for operation. No derating is required for operation below 20 °C.

How to Order

UPW	15	E	R10	V
Common Part	Size	Tolerance	Resistance Value	TCR
UPW - Ultra Precision Wire-Wound Resistors	15 - 0.125W 25 - 0.25W 30 - 0.3W 50 - 0.5W	E - 0.005% B - 0.1% L - 0.01% A - 0.2% P - 0.02% D - 0.5% W - 0.05% F - 1.0%	0.1 ohm (100 milli ohm) R10 1 ohm (1000 milli ohm) 1R0 1K ohm (1000 ohm) 1K0	V - 5ppm/°C

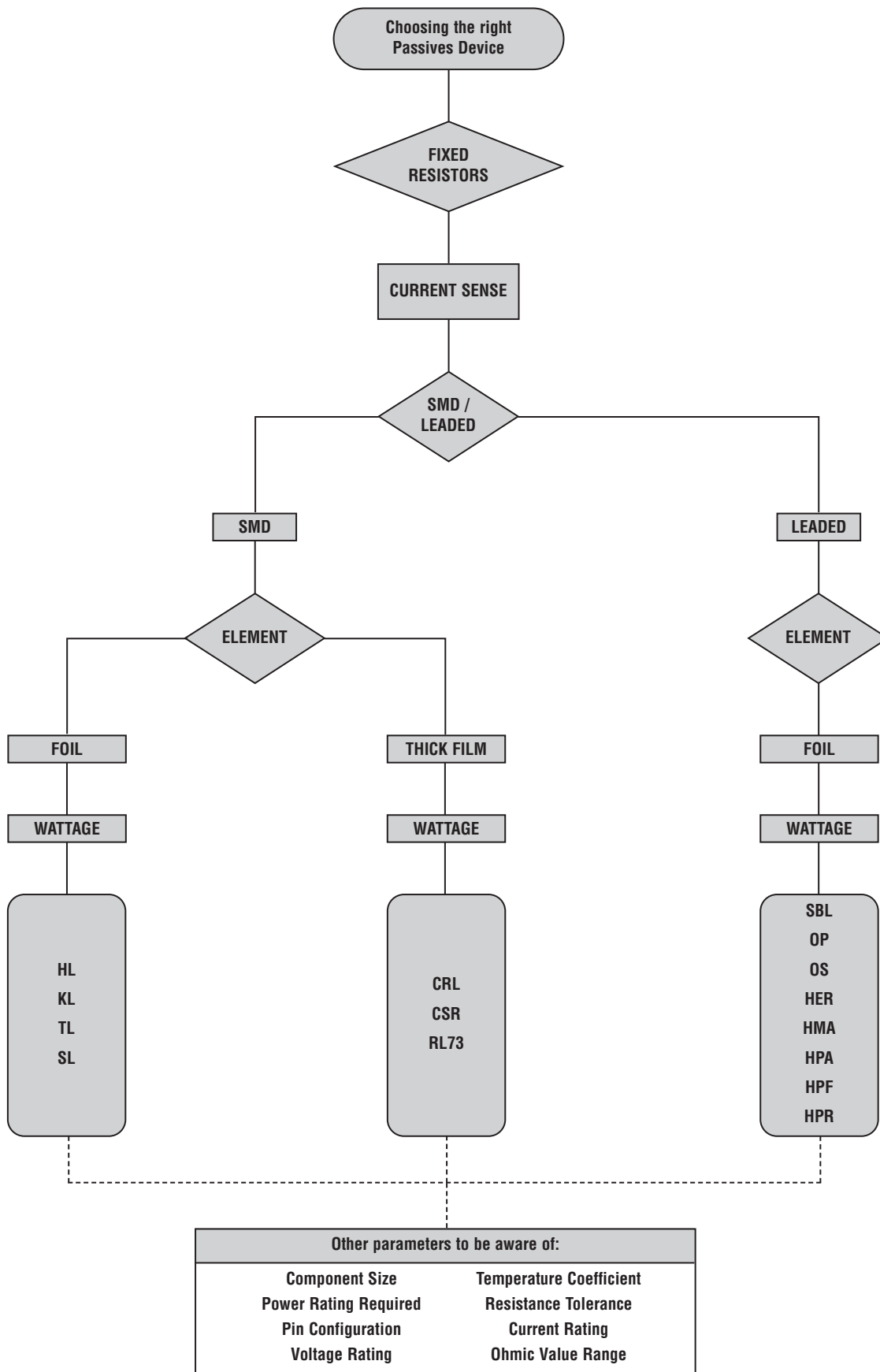

Current Sense Resistors

Product Overview

The CGS range of Current Sensing Resistors is available in Surface Mount and Leaded types. In addition a range of mounting styles including Kelvin Connection and 4 terminal leaded connection are also available.

Using technologies in Thick Film, Bulk Metal, Metal Plate and Wirewound allows this range of products to be offered in a range of sizes from 0402 SMD size to large size ceramic cased resistors, capable of dissipating 20W with a 30 Amp current rating. This range of Resistors is very suitable for current sensing in applications such as Power Supply circuits, Electric Meter sensing, Protection Feed Back circuits and a wide range of Automotive applications.

- Surface mount products down to 0402 size
- Ceramic cased resistors to 20W rating
- TCR's to 20ppm and tolerances down to 1%
- Values ranging from R0005 to 10R
- Many products stocked in Distribution
- Wide range of technologies allows best fit product

Value Range	Max Power	Lowest TCR	Tightest Tolerance	Family	Page
R001 - R50	1W	75ppm	1%	TL	26
R005 - R10	1W	50ppm	1%	HL	27
R005 - R10	2W	100ppm	1%	KL	28
R005 - R05	2W	50ppm	0.50%	CSR	29
R005 -R099	3W	100ppm	1%	SL	30-31
R10 - 10R	1W	100ppm	1%	RL73	32
R01 - 4R7	1W	200ppm	1%	CRL	33
R005 - R051	5W	200ppm	1%	SBL	34
R0005 - R002	5W	90ppm	1%	OP	35
R005 - R051	5W	100ppm	5%	OS	36
R005 - R30	5W	20ppm	5%	HER	37
R005 - R35	3W	20ppm	1%	HMA	38
R005 - R40	20W	20ppm	5%	HPA	39
R0025 -R40	20W	20ppm	5%	HPF	40
R005 - R80	10W	100ppm	5%	HPR	41
R003 - R10	5W	40ppm	1%	KNP	42

SMD Low Ohmic - Current Sense Resistors

Type TL Series

Type TL Series

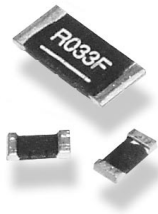

Tyco Electronics Components is pleased to offer this unique High Power, metal chip resistor for current sensing positions. It has a special metal resistive element and suitable barrier layers beneath the solder to prolong terminal life. Following the developments by semiconductor manufacturers in the production of a range of IC's for battery charge management and low voltage power supplies, the TL Series satisfies the demand for a low ohmic shunt resistor to act as a current sensor. It has particular applications in the automotive industry for sensing in EMU's.

Key Features

- Up to 1 Watt at 70°C
- Supplied on Tape
- Ideal for Current Detection
- Wide Value Range
R005 to 1R0 Possible
- Fully Automated Manufacture
- 12:06, 20:10 and 25:12 Packages Available
- Available in Distribution

Characteristics - Electrical

	1206	2010	2512
Resistance Value Range:	R003-R20	R003-R50	R001-R50
Resistance Tolerance:	± 1%		
Power Rating:	Up to 1 watt at 70°C derating to zero at 170°C		
Operating Temperature:	-65°C to +170°C		
Inductance:	< 5 NanoHenries		
T.C.R.	±75ppm/°C (R007-R20/R50)		

Mechanical

Body Construction:	Fully Welded Element
Terminations:	60/40 Tinned Copper
Coating:	Epoxy

Power Derating Curve

Type	Power Rating
TL2B	0.25 Watts
TL2H*	0.5 Watts
TL3A	1.0 Watts

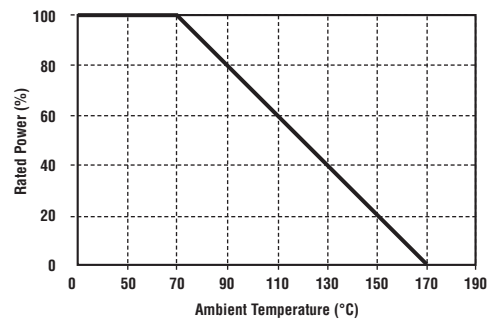

For resistors operated in ambient temperatures above 70°C, power rating must be derated in accordance with this curve.

Dimensions

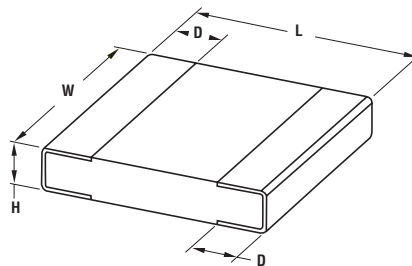

Type	L	W	H	D
TL2B	3.2	1.6	0.6	0.5
TL2H*	5.1	2.5	0.6	0.5
TL3A	6.4	3.2	0.6	0.8

How to Order

TL	3A	R015	F	TE
Common Part	Power Ratings	Resistance Value	Tolerance	Packaging
TL - Standard Part	2B - 12:06 *2H - 20:10 3A - 25:12	0.005 ohm (5 milli ohm) R005 0.015 ohm (15 milli ohms) R015 0.047 ohm (47 milli ohms) R047	F - ±1%	TE - 4000 per Reel TDG - 2000 per Reel (2512 only)

* - 20:10 available by special request. Minimum Orders of 10000 pcs to apply

SMD Low Ohmic - Current Sense Resistors

Type HL Series

Type HL Series

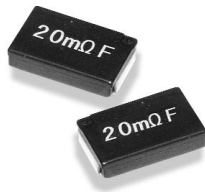

Tyco Electronics Components is pleased to offer this unique High Power, metal chip resistor for current sensing positions. It has a special metal resistive element and suitable barrier layers beneath the solder to prolong terminal life. Following the developments by semiconductor manufacturers in the production of a range of IC's for battery charge management and low voltage power supplies, the HL Series satisfies the demand for a low ohmic shunt resistor to act as a current sensor. It has particular applications in the automotive industry for sensing in EMU's.

Key Features

- Low Cost for Volume Applications
- Up to 1 Watt at 70°C
- Supplied on Tape
- Ideal for Current Detection
- Wide Value Range R005 to R10 Possible
- Fully Automated Manufacture
- 25:12 Package

Characteristics - Electrical

Resistance Value Range:	R005 - R10
Resistance Tolerance:	±1%, ±5%
Power Rating:	1 watt at 70°C derating to zero at 155°C
Operating Temperature:	-55°C to +155°C
T.C.R.:	±50ppm, ±100ppm/°C ≥R01 ~ ±200ppm/°C <R01

Mechanical

Fully Welded Element
Copper (Solder Plated) Terminations
Heat Resistant Resin Moulding
Weight: 0.067 grams typical

Derating Curve

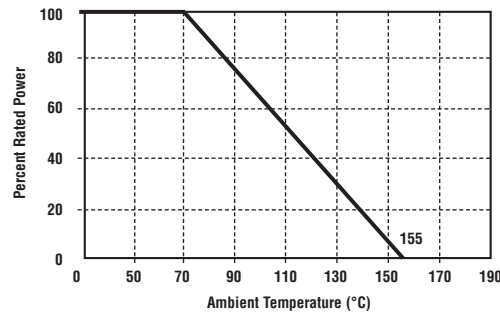

For resistors operated in ambient temperatures above 70°C, power rating must be derated in accordance with this curve.

Dimensions

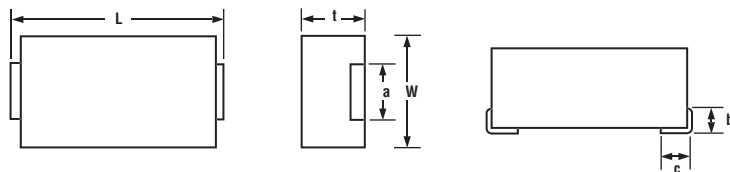

Standard Reel Size: 25:12 1000 per 7" Reel

L ±0.5	W ±0.3	t ±0.3	a ±0.3	b ±0.3	c ±0.3
6.2	3.1	1.0	2.5	0.8	1.2

How to Order

HL	3A	H	R015	F	TDF
Common Part	Size	T.C.R.	Resistance Value	Tolerance	Packaging
HL - Standard part	3A - 25:12	G - 50ppm/°C H - 100ppm/°C T - 200ppm/°C	0.005 ohm (5 milli ohm) R005 0.015 ohm (15 milli ohms) R015 0.047 ohm (47 milli ohms) R047	F - ±1% J - ±5%	TDF - 1000 per Reel

Type KL Series

Type KL Series

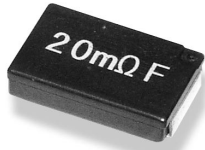

Tyco Electronics Components is pleased to offer this unique High Power, metal chip resistor for current sensing positions. It has a special metal resistive element and suitable barrier layers beneath the solder to prolong terminal life. Following the developments by semiconductor manufacturers in the production of a range of IC's for battery charge management and low voltage power supplies, the KL Series satisfies the demand for a low ohmic shunt resistor to act as a current sensor. It has particular applications in the automotive industry for sensing in EMU's.

Key Features

- 2 Watts at 70°C
- Supplied on Tape
- Ideal for Current Detection
- Wide Value Range
R005 to R10 Possible
- Fully Automated Manufacture

Characteristics - Electrical

Resistance Value Range:	R005 - R10
Resistance Value Grid:	E24
Resistance Tolerance:	±5%, ±1%
Power Rating:	2 Watts at 70°C (zero at 180°C)
Voltage Rating:	$\sqrt{\text{Power} \times \text{Resistance}}$
Operating Temperature:	-55°C to +180°C
Inductance:	≤ 5 Nanohenries
T.C.R.	R ≤ R013 ±180ppm/°C, R ≤ R015 ±100ppm/°C
Insulation Resistance:	<10,000 Meg Ohms

Mechanical

Body Construction:	Fully Welded Element
Terminations:	60/40 Tinned Copper
Coating:	Epoxy

Power Rating Curve

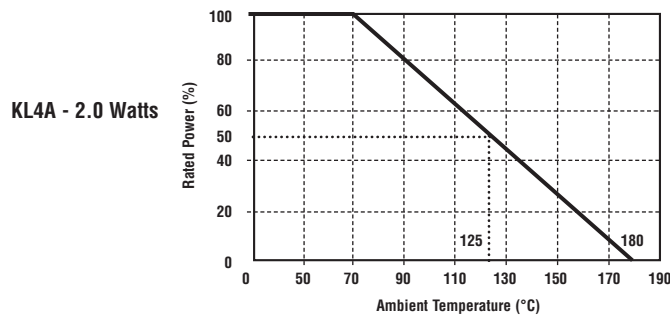

For resistors operated in ambient temperatures above 70°C, power rating must be derated in accordance with this curve.

Dimensions

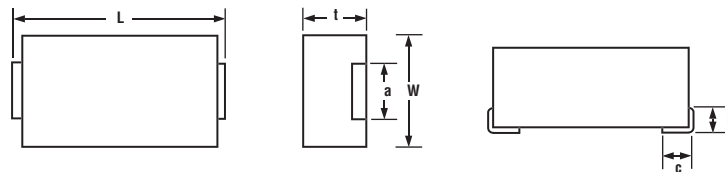

Style	L±0.3	W±0.2	t±0.2	a±0.2	b±0.2	c±0.3
KL4A	11.5	7.0	2.5	5.0	1.7	2.6

How to Order

KL	4A	R10	F	TN
Common Part	Power Rating	Resistance Value	Tolerance	Packaging
KL - Standard Part	4A - 2 Watts	0.01 ohm (10 milliohms) R01 0.1 ohm (100 milliohms) R10	F - ±1% J - ±5%	TN - Taped 1000 on Reel

SMD Power Resistor (Current Sensing)

Type CSR Series

Type CSR Series



The CSR Resistor Series is a unique development available from Tyco Electronics Components in that it offers Kelvin connections in a 1 & 2 watt low ohmic resistor designed for current sensing. The CSR utilises fully welded construction techniques unlike other designs which rely solely on tinned termination connections. These features allow the CSR Resistor Series to withstand the higher temperatures associated with reflow, vapour phase, or infrared (IR) manufacturing processes without degradation.

Key Features

- 1 & 2 Watt Styles
- Tolerances down to $\pm 0.5\%$
- Kelvin Connections
- TCR 50 ppm/°C
- Stable On Board Performance
- Ideal for Current Sensing

Characteristics - Electrical

	CSR-1	CSR-2
Power Rating at 70°C:	1W	2W
Resistance Range (milli Ohms):	5-50	5-50
Resistance Tolerance:	D ($\pm 0.5\%$) F ($\pm 1\%$)	F ($\pm 1\%$)
T.C.R. ppm/°C:	± 50	± 50
Operating Temperature Range:	-55°C to +125°C	-55°C to +125°C

Example of CSR Application - Only for Direct Current, Low Voltage Applications

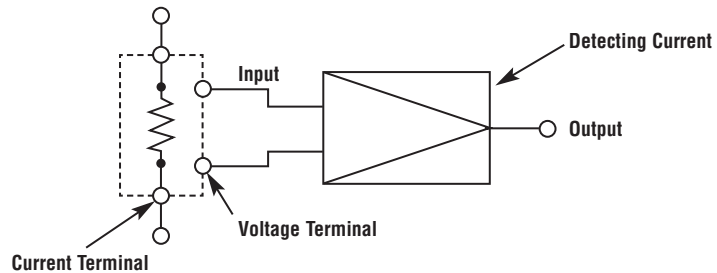

Sensed Voltage shall be within the rated voltage of the Sensing IC

Dimensions

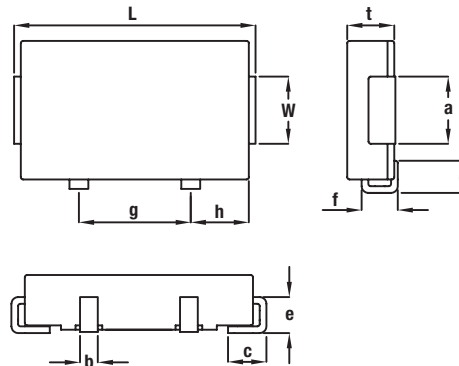

Style	L	W	t	a	b	c	d	e	f	g	h
CSR-1	10.8 \pm 0.5	6.2 \pm 0.3	2.1 \pm 0.2	3.0 \pm 0.3	0.8 \pm 0.2	1.4 \pm 0.5	1.2 \pm 0.5	1.3 \pm 0.3	1.3 \pm 0.3	5.0 \pm 0.1	2.5 \pm 0.1
CSR-2	12.8 \pm 0.5	8.2 \pm 0.3	3.1 \pm 0.2	5.0 \pm 0.3	1.0 \pm 0.2	2.0 \pm 0.5	2.0 \pm 0.5	2.2 \pm 0.3	2.2 \pm 0.3	6.0 \pm 0.1	3.0 \pm 0.1

How to Order

CSR	1	R10	F	T
Common Part	Power Rating	Resistance Value	Resistor Tolerance	Pack Style
CSR - 4 Terminal Current Sense Resistor	1 - 1 Watt 2 - 2 Watt	0.001 Ohm (1 milli Ohm) R001 0.1 Ohm (100 milli Ohm) R10	D - $\pm 0.5\%$ F - $\pm 1\%$	- Loose T - Tape And Reel

SMD Current Sense Resistors

Type S Series

Type S Series



Tyco Electronics Components introduces a range of surface mount power resistors to meet today's circuit design needs. One design concept allows an engineer to choose from three styles (Lo Ohm, Power, or Ultra Precision) while staying within the new standard circuit board land pattern guidelines now accepted by the wirewound resistor industry. Each size offers low profile case design with flexible tinned copper terminations for reliable solder joints. All styles utilise a fully welded construction technique, unlike other designs that rely solely on tinned termination connections. These features allow the S Series to withstand the higher temperatures associated with reflow, vapour phase, or infrared (IR) manufacturing processes without degradation.

Key Features

- Low Profile Design
- Available on Tape (3 Reel Sizes)
- Very Wide Value Range
- Ideal for Current Sensing
- Up to 3.0 Watts Power
- High TCR Versions (to 6000ppm)
- Stable to 5ppm/°C

Characteristics - Electrical

	"SL" Lo Ohm	"SP" Power
Values S1/2:	R01 - R05	R06 - 1K4
Values S1:	R005 - R075	R10 - 5K0
Values S2:	R005 - R099	R10 - 10K
Values S3:	R005 - R099	R10 - 45K
Grid:	E24	E96
Resistance Tolerances:	1%, 3%, 5%.	0.1% to 5%.
Power Rating @ 25°C S1/2:	0.5 Watt	0.75 Watts
Power Rating @ 25°C S1:	1 Watt	1.5 Watt
Power Rating @ 25°C S2:	2 Watts	2.5 Watts
Power Rating @ 25°C S3:	3 Watts	3.5 Watts
Derating:	See Curve Below	See Curve Below
Max. Operating Voltage S1/2:	$\sqrt{\text{Power} \times \text{Resistance}}$	33 Volts
Max Operating Voltage S1:	$\sqrt{\text{Power} \times \text{Resistance}}$	58 Volts
Max Operating Voltage S2:	$\sqrt{\text{Power} \times \text{Resistance}}$	127 Volts
Max Operating Voltage S3:	$\sqrt{\text{Power} \times \text{Resistance}}$	212 Volts
Inductance:	< 7 Nanohenries	----

Environmental

		Typical ΔR
Solder Immersion:	260°C for 10 seconds.	0.1%
Load Life:	2000 hours at rated power at 25°C.	0.2%
Moisture Resistance:	240 hours with humidity ranging from 80% RH to 98% RH.	0.1%
Thermal Shock:	-55°C for 15 minutes no load.	0.1%
Dielectric Withstand:	1000 Volts.	
Short Term Overload:	5 times rated power for 5 seconds	0.1%
Solderability:	95% coverage within 1/16" of contact point.	----
Flammability:	UL94V Rating.	----

Temperature Coefficient of Resistance

Range	(L) Low Ohm	(P) Power
R005 - R20	<100 PPM	
R10 - R99		±30ppm
1R0 - 10R		±20ppm
11R - 99R		±90ppm
100R and over		±50ppm

NB: High TCR Type Available to 6000ppm/°C

Power Derating

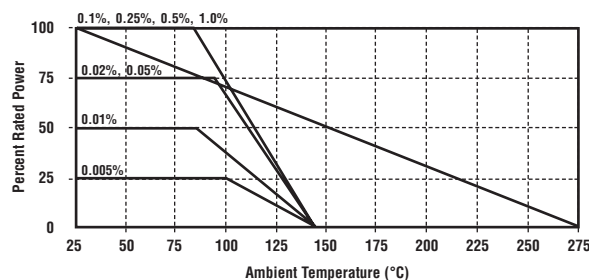

Note: U Style derates to 145°C. All others derate to 275°C

Type S Series (continued)

Dimensions

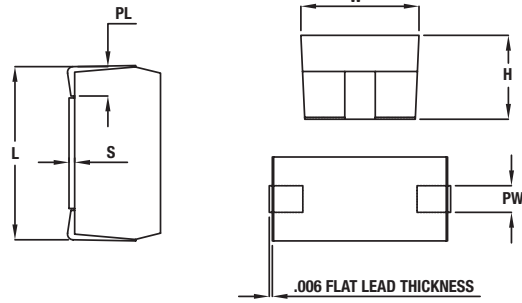

Size	Length (L)	Width (W)	Height (H)	Stand Off (S)	Pad Width (PW)	Pad Length (PL)
S 1/2	5.46	3.18	2.54	n/a	1.27	1.02
S1	6.48	3.81	2.84	0.50	1.27	1.25
S2	12.14	5.84	5.33	0.50	2.54	2.54
S3	15.24	7.00	6.48	0.50	2.29	1.27

Land Pattern

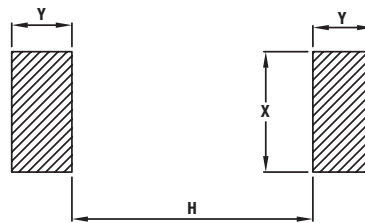

Type	H	J	X	Y
S 1/2	1.91	4.45	1.78	2.54
S1	3.43	5.97	2.03	2.54
S2	6.98	10.54	3.05	3.56
S3	10.42	14.78	2.80	3.56

Cleaning Conditions

After soldering use cleaning solvents such as chlorosol, dyefreon, suitable aqueous or semi aqueous cleaner.

Storage

To prevent damage to the electrode, be sure to observe the following cautions for storage.

- Store in 40°C maximum ambient temperature, and 70% maximum R.H.
- For maximum possible shelf life do not disturb polythene sleeve until you are ready to use.
- Store where there are no harmful gases containing sulphur or chlorine.

How to Order

S	L	1	1R0	J	T
Common Part	Resistor Type	Case Size	Resistance Value	Absolute Tol. at +25°C	Pack Style
S - Standard Part	L - Low Ohmic P - Power	1/2 - 5.5 x 3.2 1 - 6.5 x 3.8 2 - 12.1 x 5.9 3 - 15.3 x 7.0	0.1 Ohm (100 milli ohms) R10 1 Ohm (1000 milli ohms) 1R0 1K Ohm (1000 Ohms) 1K0	K ±10% J ±5% E ±3% F ±1% D ±0.5% C ±0.25% B ±0.1% A ±0.05% Q ±0.02% T ±0.01% Z ±0.005%	L - Loose Piece R - S_1 500 pcs 7" Reel S - S_1 1000 pcs 13" Reel W - S_2 1000 pcs 13" Reel

Type RL73 Series

Type RL73 Series

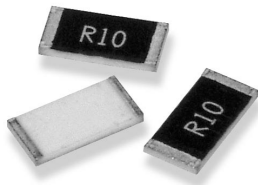

Tyco Electronics Components is pleased to offer this thick film chip resistor for current sensing positions. It has a special metal glaze resistive element and a nickel barrier layer beneath the solder to prolong terminal life. Following the developments by semiconductor manufacturers in the production of a range of IC's for battery charge management and low voltage power supplies, the RL73 Series satisfies the demand for a low ohmic shunt resistor to act as a current sensor.

Key Features

- Up to 1 Watt at 70°C
- Values Down to R10
- 7 Chip Sizes
- Ideal for Current Detection
- Value Marked on Resistor
- Lab Kits Available on Request
- Sizes 0402 to 2512
- 0402, 0603, 0805, 1206, 2512 stocked in Distribution

Characteristics - Electrical

Type	T.C.R.	Power Rating @ 70°C	Max. Working Voltage	Max. Overload Voltage	Resistance Range		Taping & Qty Per 7" Reel		
					*F(±1%), E96, E24	G(±2%), J(±5%), E24	TP	TD	TE
RL73N1E	± 300	0.10W	-	-	-	R20 - R91	10000	-	-
RL73N1J	± 300				-	R20 - R91			
RL73H2A	± 100	0.125W	1.11V	2.79V	R20-10R	-	-	5000	-
RL73K2A	± 200				-	R10-10R			
RL73H2B	± 100	0.25W	1.58V	3.95V	R20-10R	-	-	5000	-
RL73K2B	± 200				-	R10-10R			
RL73H2E	± 100	0.5W	2.23V	5.59V	R20-10R	-	-	5000	-
RL73K2E	± 200				-	R10-10R			
RL73H2H	± 100	0.75W	2.73V	6.84V	R20-10R	-	-	-	4000
RL73K2H	± 200				-	R10-10R			
RL73H3A	± 100	1.0W	3.16V	7.90V	R20-10R	-	-	-	4000
*RL73K3A	± 200				-	R10-10R			

Power Derating Curve

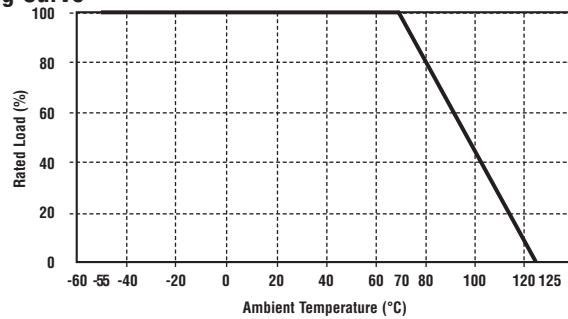

If this device is expected to run at full continuous power then action to improve the cooling should be taken. This can be a metal substrate, copper pad left under the chip, an opening in the PCB or extra large solder pads.

*** Recommended Circuit Board Design**

For resistors operated in ambient temperatures above 70°C, power rating must be derated in accordance with this curve.

Dimensions

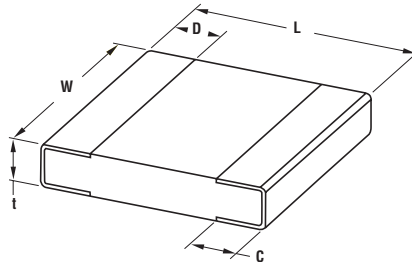

Part Number	L±0.2	W	C	D ^{+0.2} _{0.1}	t±0.1
RL73 1E	1.0	0.5 ±0.05	0.25 ±0.1	0.2 ±0.1	0.35
RL73 1J	1.6	0.8 ±0.15	0.3 ±0.1	0.3 ±0.2	0.45
RL73 2A	2.0	1.25±0.1	0.4±0.2	0.3	0.5
RL73 2B	3.2	1.6±0.2	0.5±0.3	0.4	0.6
RL73 2E		2.6±0.2			
RL73 2H	5.0	2.5±0.2			
RL73 3A	6.3	3.1±0.2			

How to Order

RL73K	3A	R10	J	TE
Common Part	Rated Power	Resistor Value	Tolerance	Packaging
RL73K - Standard * RL73H - 100ppm/°C * See table Above RL73N - 300ppm/°C	See Above e.g. 3A - 1W	0.1 Ohm (100 milli Ohm) R10 1 Ohm (1000 milli Ohm) 1R0 10 Ohm (10000 milli ohm) 10R	J ±5% G ±2% * F ±1% * See Table Above	TE - 4000 (RL73_3A, RL73_2H Only) TD - 5000 (RL73_2A, RL73_2B, RL73_2E Only) TP - 10,000 (RL73_1E, RL73_1J Only)

Type CRL Series

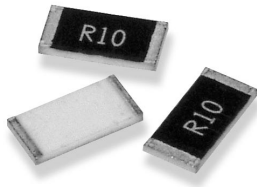

Tyco Electronics Components is pleased to offer this High Power, thick film chip resistor for current sensing positions. It has a special metal glaze resistive element and a barrier layer underneath the solder to prolong terminal life. Following the developments by semiconductor manufacturers in the production of a range of IC's for battery charge management and low voltage power supplies, these resistors satisfy the demand for a low ohmic shunt resistor to act as a current sensor. Unique parallel print enables very low values and high powers for thick film resistors.

Key Features

- Up to 1 Watt at 70°C
- Values Down to R01
- Supplied on Tape
- Ideal for Current Detection
- 0.5 Watt by 0805 x 3
- 1 Watt by 0805 x 6

Type CRL Series

Characteristics - Electrical

	CRL1220		CRL3720		CRL7520	
Power Rating at 70°C	1/4W		1/2W		1W	
Resistance Range	22mΩ-68mΩ	0.1Ω-4.7Ω	22mΩ-68mΩ	0.1Ω	10mΩ-68mΩ	0.1Ω
Resistance Tolerance	2% - 5%	1%	1% - 2%	1% - 2%	1% - 2%	1% - 2%
Temperature Coefficient of Resistance	0~+350ppm/°C	0~+200ppm/°C	0~+350ppm/°C	0~+200ppm/°C	0~+350ppm/°C	0~+200ppm/°C
Resistance Values	E6		E6*		E6*	
Max. Operating Temperature	±125°C					
Short Time Overload	±0.5%					
Load Life	±0.5%					
Moisture Life	±0.5%					
Temperature Cycle	±0.5%					
Resistance to Solder Heat	±0.5%					

* For 1/2 W Additional Existing Value: R025, R04, R05, R075

* For 1 W Additional Existing Value: R018, R02, R025, R04, R05, R075

Derating Curve

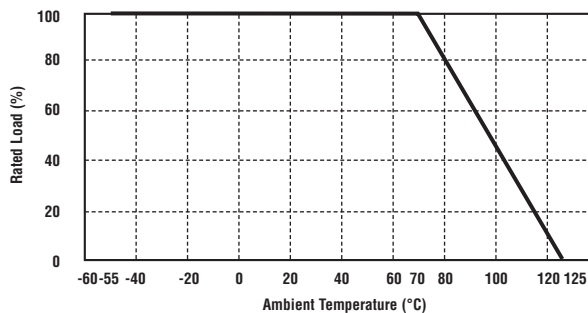

For resistors operated in ambient temperatures above 70°C, power rating must be derated in accordance with this curve.

Dimensions

Handling Recommendations

When flow soldering - the land width must be smaller than the chip resistor width to control the solder application. Generally, the land width can be chip resistor width x 0.7 to 0.8. When reflow soldering - The amount of solder can be adjusted. Thus the land width can be set to W x 1.0 to 1.3.

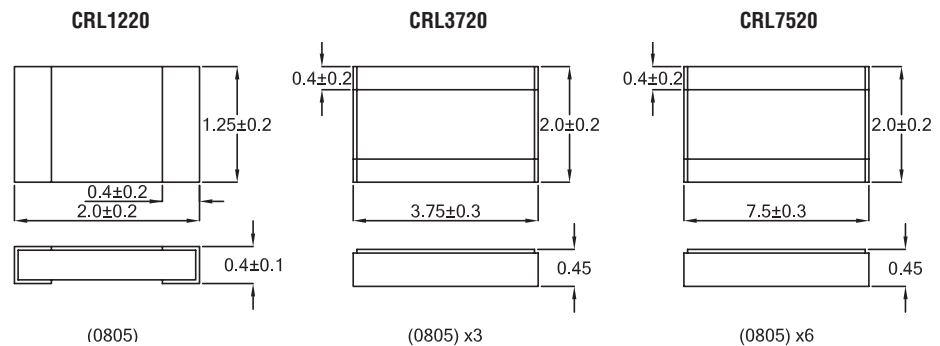

How to Order

CRL	1220	T	R10	J	TD
Common Part	Size	Temp. Coefficient	Resistor Value	Tolerance	Packaging
CRL - Standard	See Above e.g. 1220 1/4W	S - ±200ppm/°C T - ±350ppm/°C	0.1 ohm (100 milli ohm) R10 1 ohm (1000 milli ohm) 1R0	J - ±5% G - ±2% F - ±1%	TD - Taped 5000 on reel

Low Ohmic - Current Sense Resistors

Type SBL Series

Type SBL Series



The SBL Series is a low ohmic non-inductive resistor with a low temperature coefficient in a fully insulated ceramic housing. It is ideal for applications in power supply regulation, motor control current monitoring, feedback control loops, overload sensors and radio frequency applications. The solid metal element has welded copper terminals and is encapsulated in a ceramic housing, filled with compressed silica sand.

Key Features

- 4 Watts & 5 Watts Versions
- Solid Metal Element
- Non-Inductive
- Low Temperature Coefficient
- High Reliability
- Custom Design (Subject to Volume)
- 4 Watt Device Available in Distribution

Characteristics - Electrical

Resistance Values (4 Watt):	R005, R01, R015, R018, R022, R033, R047, R051
Resistance Values (5 Watt):	R01, R015, R018, R022, R033, R047, R051
Resistance Tolerance:	± 5%
Rated Dissipation (4 Watt):	4 Watts at 70°C
Rated Dissipation (5 Watt):	5 Watts at 70°C
Dielectric Strength:	2000 Volts
Insulation Resistance:	< 10000 Mohms
Maximum Continuous Working Voltage:	$\sqrt{\text{Power} \times \text{Resistance}}$ AC RMS

Mechanical

Climatic Category:	-55 / 250 / 56
Temperature Range:	-55°C to +250°C
Derating:	Linear from 70°C to 250°C

Environmental

Resistance to Solder Heat:	260°C ($\Delta R \pm 0.2\%$ typical)
Terminal Strength:	3lb pull test
Solderability:	Meets MIL Std 202
Marking:	Black ink on ceramic body - Manufacturer, Resistance Value and Tolerance

Temperature Rise

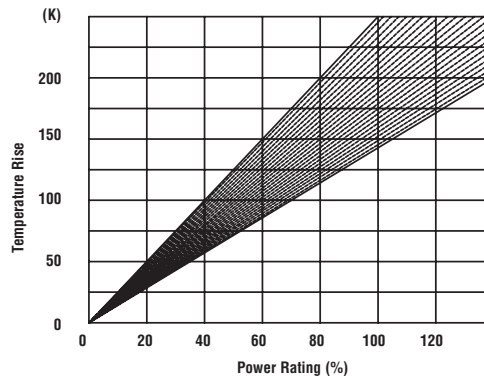

Dimensions

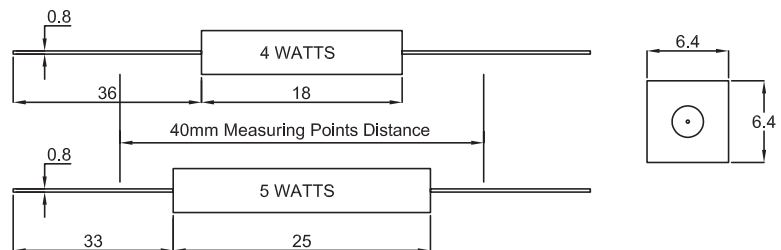

How to Order

SBL	4	R051	J
Common Part	Power Dissipation	Resistance Value	Tolerance
SBL - Standard	4 - 4 Watts 5 - 5 Watts	R005, R01, R015, R018, R022, R033, R047, R051 (5 Watt Version only R01 - R051)	J ±5% F ±1%

Type OP Series

Type OP Series



The OP Series is designed for current sensing using a range of low TCR resistive alloys to create the value and current capability you require. The ribbon is welded to 2mm diameter solid (OFHC) copper leads that are tin/copper electroplated. The OP is ideally suited to current detection in power supply circuits, electric metre sensing, protection feed back circuits and a wide range of automotive positions.

Key Features

- Small Size Light Weight
- Easy to Mount
- Very Low Inductance
- Temperature Range -55°C to +155°C
- High Power - 5 Watts
- Custom Designs Welcomed
- RoHS Compliant

Characteristics - Electrical

Resistance Value:	R005 – R002
Resistance Tolerance (%):	1%, 5%
Temperature Coefficient of Resistance:	90ppm/°C
Inductance:	<30nH
Short term Overload:	5 Times rated power for 5 seconds
Power Rating (W):	5W
Temperature Range:	-55°C to +155°C
Terminals:	Tin / Silver

Derating Curve

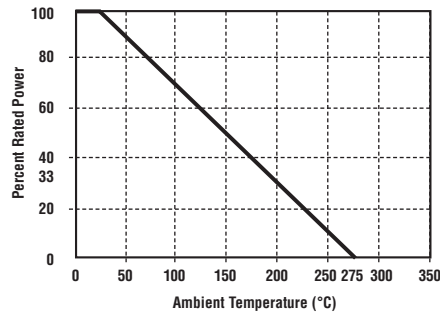

For ambient temperatures above 25°C derate accordingly to the above curve.

Dimensions

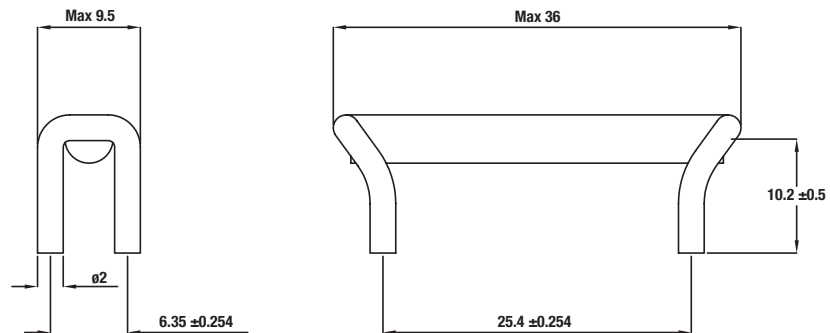

How to Order

OP	5	R005	F
Common Part	Power Rating	Resistance Value	Tolerance
OP - Power Low Ohmic Shunt	5 Watts	0.005 ohm (5 milli ohm) R005 0.01 ohm (10 milli ohm) R01 0.1 ohm (100 milli ohm) R10	F - ±1% J - ±5%

Type OS Series

Type OS Series



The OS Series is designed for current sensing using a range of low TCR resistive alloys to create the value and current capability you require.

The ribbon is welded to 1mm diameter solid (OFHC) copper leads that are tin/lead electroplated. The OS is ideally suited to current detection in power supply circuits, electric meter sensing, protection feed back circuits and a wide range of automotive positions.

Key Features

- Small Size Light Weight
- Easy to Mount
- Completely Non Inductive
- Temperature Range -55°C to +155°C
- High Power up to 5 Watts
- High Current up to 14 Amps
- Custom Designs Welcomed

Characteristics - Electrical

Resistance Value:	R005, R01, R015, R022, R025, R033, R047, R051 (or custom)
Resistance Tolerance:	5%, 10% (tighter by discussion)
Temperature Coefficient of Resistance:	Material 20ppm/°C Effective 100ppm/°C over range
Rated Ambient Temperature:	+70°C
Operating Temperature Range:	- 40°C + 200°C
Load Life @ 125°C:	1000 hours $\Delta R < \pm 2\%$ max.
Temperature Cycling:	- 40°C + 125°C 1000 $\Delta R < \pm 2\%$ max.
Moisture No Load:	1000 hours $\Delta R < \pm 1\%$ max.
Pack Quantity:	500 boxed - loose pack

Temperature Rise Curve

Typical Temperature Rise Under Load Condition Type OS3

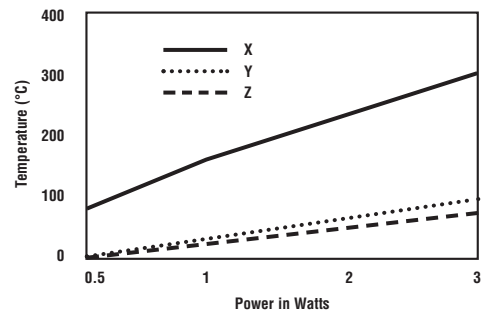
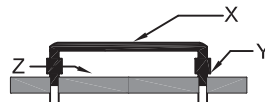

Dimensions

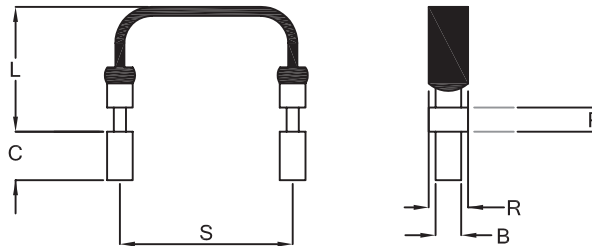

Type	S	L	C ±0.25	P ±0.1	R ±0.1	B ±0.05
OS-1	11.43	5.0±2.5	3.2	1.2	2.0	1.7
OS-3	15.20	25.4 Max	3.2	1.2	2.0	1.7
OS-5	20.30	25.4 Max	3.2	1.2	2.0	1.7

How to Order

OS	3	R01	15	J
Common Part	Rated Power	Resistance Value	Insertion Pitch	Tolerance
OS - Open Wire Resistor (Radial) LW - Leaded Wire (Axial) Resistor (Custom)	1 - 1 Watt 3 - 3 Watt 5 - 5 Watt (Or Custom)	0.01 Ohm (10 milli Ohm) R01	12 - 12mm 15 - 15mm 20 - 20mm	J ±5% K ±10% Tighter by Discussion

Type HER Series

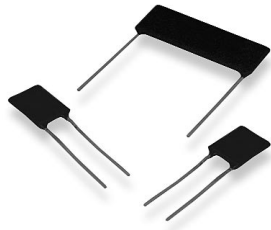

Tyco Electronics Components offer a range of metal plate power shunt resistors. The HER Series is ideal for power applications at an economical price. These resistors have low TCR's and inductance characteristics along with flameproof coatings.

Key Features

- Up to 5 Watts
- Low Values (R005 - R30)
- Metal Plate Construction
- Low TCR Rating
- Low Inductance
- Flameproof Coating

Derating Curve

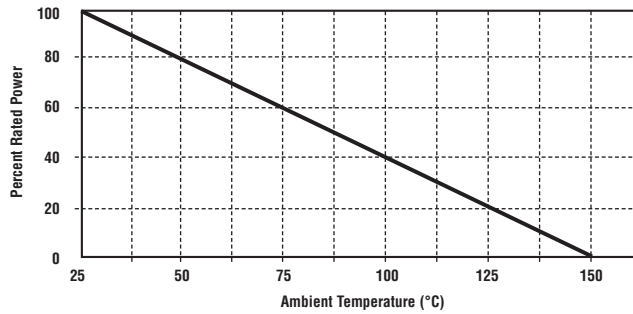

Dimensions V05

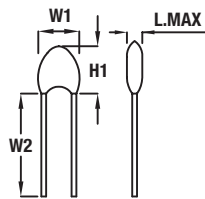

V09

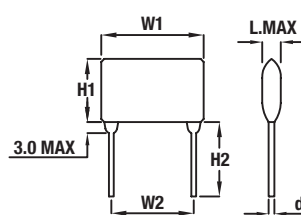

H20

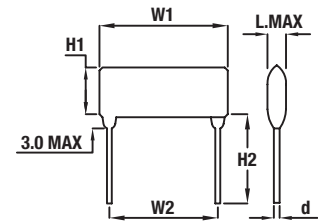

Type	Dimensions						Rated Wattage	Resistance Range (Ohms)
	W±1.5	W2±1.5	H1±2.5	H2±1.5	L±1.5	d±0.02		
HERV05 1	8.5	5	8	22	5.0	0.8	1W	10m - 100m
HERV09 2	11.5	9	12	22	4.5	0.8	2W	5m - 200m
HERV09 5	11.5	9	26	22	4.5	0.8	5W	26m - 200m
						1.0		5m - 25m
HERH20 5	24.5	20	12	22	4.5	0.8	5W	21m - 300m
						1.0		5m - 20m

How to Order

HER	V05	5	R10	J
Common Part	Package Style	Power	Resistance Value	Tolerance
HER - Radial Epoxy Coated Shunt	H20 - Low Profile V05 - Bead Shape V09 - Standard Radial	1 - 1 Watt 2 - 2 Watt 5 - 5 Watt	R005 - 5 milli ohms R30 - 300 milli ohms	J ±5%

Current Sense Resistors

Low Ohm Shunt

Type HMA Series

Type HMA Series



Tyco Electronics Components offer a range of metal plate shunt resistors. The HMA Series is an axial moulded resistor ideal for current sensing applications including switching and linear power supplies, instrumentation and power amplification.

Key Features

- 3 Watt Moulded Axial Package
- Low Temperature Coefficient
- Low Inductance
- Metal Plate Construction
- Low Values (R005 to R35)

Characteristics - Electrical

Resistance Range:	0.005 ohm to 0.35 ohm
Resistance Tolerance:	±1%, ±3%, ±5%, ±10%. Lower tolerances available as specials
Temperature Coefficient:	20ppm - 90ppm
Dielectric Strength:	500 Vac
Insulation Resistance:	1000 Meg ohm minimum dry
Short Time Overload:	5 seconds at 5 x rated power

Mechanical

Terminal Strength:	4.5 kg pull
Solderability:	Satisfactory when tested in accordance with method 208 of MIL - STD - 202

Environmental

Test	Maximum
Thermal Shock:	± 0.2%
Short Time Overload:	± 0.5%
Terminal Strength:	± 0.1%
Dielectric Withstand Voltage:	± 0.1%
High Temperature Exposure:	± 1.0%
Moisture Resistance:	± 0.2%
Low Temperature Storage:	± 0.2%
Vibration/High Frequency:	± 0.1%

Dimensions

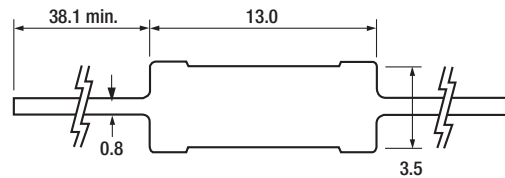

Power Derating Curve

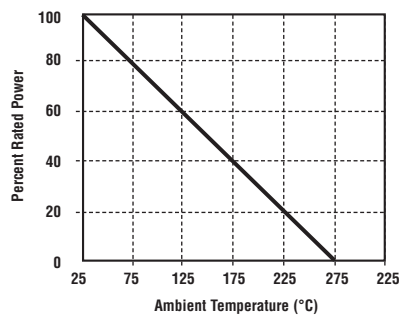

Surface Temp. vs Power

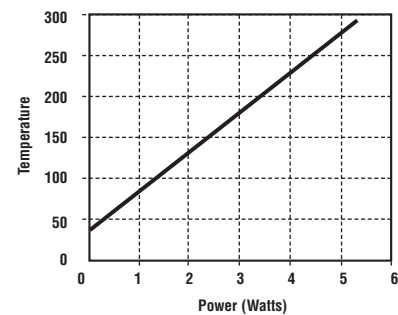

How to Order

HMA	3	R10	F
Common Part	Power Dissipation	Resistance Value	Tolerance
HMA - Moulded Axial Shunt Resistor	3 - 3 Watts at 70°C	R005 - 5 milli ohms R35 - 350 milli ohms	F - ±1% E - ±3% J - ±5% K - ±10%

Low Ohm Shunt

Type HPA Series

Type HPA Series



Tyco Electronics Components offer a range of Metal Plate Power Shunt resistors. The HPA Series is an Axial Ceramic resistor for use in current sensing applications. The wide Wattage range (1 - 20 Watts) enables the HPA Series to cover most applications.

Key Features

- 8 Sizes (1W - 20W)
- Up to 20W Dissipation
- Ceramic Construction
- Low Values (R005 to R40)
- Moulded Axial

Characteristics - Electrical

	HPA 1	HPA 2	HPA 3	HPA 5	HPA 7	HPA 10	HPA 15	HPA20
Rated Wattage:	1	2	3	5	7	10	15	20
Resistance Range (Ohms):	5m-30m	5m-50m	5m-100m	5m-100m	10m-120m	10m-300m	10m-300m	10m-400m

Derating Curve

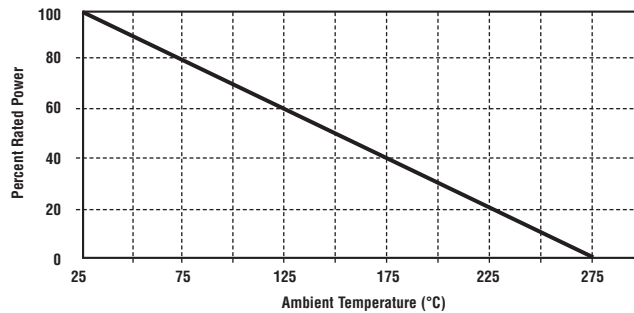

Dimensions

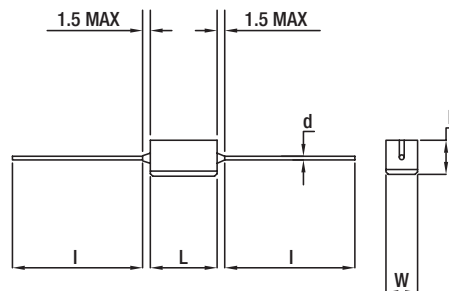

Type	Dimensions				
	L±1.0	W±1.0	H±1.0	I (Min)	d±0.02
HPA2 1	13.0	6.5	7.0	35	0.8
HPA2 2	18.0	6.5	7.0	35	0.8
HPA2 3	22.0	8.0	8.5	35	0.8
HPA2 5	21.5	9.5	9.5	35	0.8
HPA2 7	34.5	9.5	9.5	35	0.8
HPA2 10	48.0	9.5	9.5	35	1.0
HPA2 15	48.0	12.5	12.5	35	1.0
HPA2 20	62.5	12.5	12.5	35	1.0

How to Order

HPA	7	R10	J
Common Part	Power Dissipation	Resistance Value	Tolerance
HPA2 - Ceramic 2 Wire Shunt	3 - 3 Watts 5 - 5 Watts 7 - 7 Watts 10 - 10 Watts 15 - 15 Watts 20 - 20 Watts	R005 - 5 milli ohms R40 - 400 milli ohms	J - ±5%

Current Sense Resistors

Low Ohm Shunt

Type HPF Series

Type HPF Series

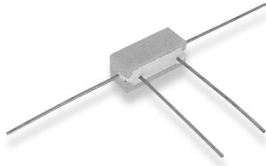

Tyco Electronics Components offer a range of metal plate shunt resistors. The HPF Series is a 4 wire moulded device for current sensing applications to facilitate dual mounting requirements to minimise stock profiles. A wide power range of 2 to 20 Watts is available which will suit most applications.

Key Features

- Wide Versatile Mounting Styles
- Low Cost Solution
- Moulded Package
- Values Down to R0025
- 7 Sizes (2W to 20W)

Characteristics - Electrical

	HPF 2	HPF 3	HPF 5	HPF 7	HPF 10	HPF 15	HPF 20
Rated Wattage:	2	2	5	7	10	15	20
Resistance Range (Ohms):	2.5m-50m	5m-100m	5m-100m	10m-120m	10m-300m	10m-300m	10m-400m

Derating Curve

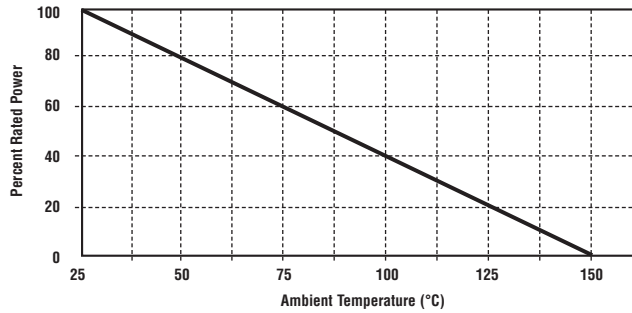

Dimensions

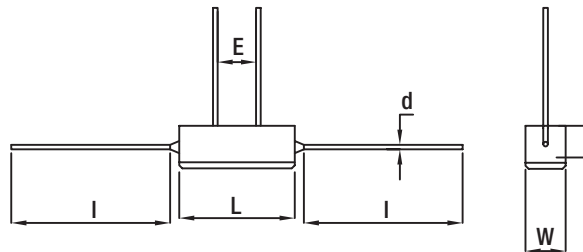

Type	Dimensions					
	L±1.0	W±1.0	H±1.0	E ±2.0	I (Min)	d±0.02
HPF4 2	18.0	7.0	7.5	9.0	33	0.8
HPF4 3	22.0	8.0	8.5	13.0	33	0.8
HPF4 5	21.5	9.5	9.5	13.0	33	0.8
HPF4 7	34.5	9.5	9.5	25.0	33	0.8
HPF4 10	48.0	9.5	9.5	33.0	33	1.0
HPF4 15	48.0	12.5	12.5	35.0	33	1.0
HPF4 20	62.5	12.5	12.5	45.0	33	1.0

How to Order

HPF	7	R10	J
Common Part	Power Dissipation	Resistance Value	Tolerance
HPF4 - Ceramic Kelvin Shunt	3 - 3 Watts 5 - 5 Watts 7 - 7 Watts 10 - 10 Watts 15 - 15 Watts 20 - 20 Watts	R0025 - 2.5 milli ohms R005 - 5 milli ohms R40 - 400 milli ohms	J - ±5%

Low Ohm Shunt

Type HPR Series

Type HPR Series

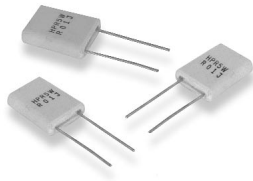

The HPR Series is a radial low ohm resistor for current sensing in a range of instrumentation and control equipment. Wattage ranges from 2 to 7 Watts in a slim line ceramic package.

Key Features

- 2 to 7 Watts Radial Ceramic
- Very Low Inductance
- Low Profile Version
- R005 to R80 Value Range
- Up to 30 Amps Current Rating
- ±100ppm/°C Temperature Coefficient

Characteristics - Electrical

Resistance Range:	R005 - R80
Insulation Resistance:	1000 Meg ohms minimum
Maximum Current:	2 watt - 5 watt 15A, 7 watt - 10 watt 30A
Temperature Coefficient:	± 100ppm/°C
Terminal Strength:	Radial 1kg - Axial 4.5kg
Measuring Point:	Axial type 10mm. ± 0.5 from body Radial type 4mm. ± 0.5 from body

Derating Curve

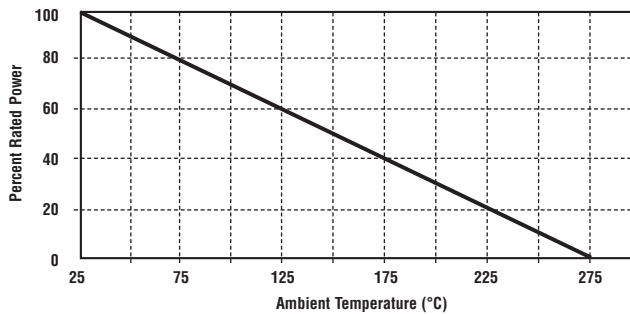

Dimensions

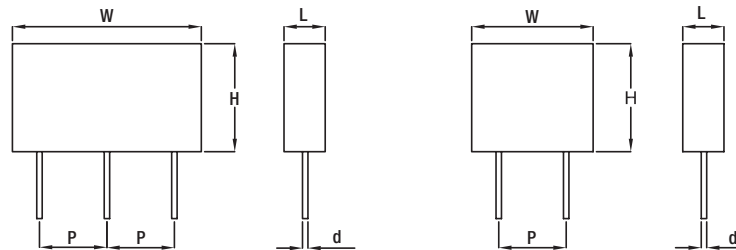

Type	Dimensions					Rated Wattage	Resistance Range (Ohms)
	W±1.0	L±1.0	H±1.0	P±0.5	d±0.02		
2 Wire							
HPR 02R	14.0	5.0	18.5	10.0	0.8	2W	5m - 500m
HPR 03R	14.0	5.0	13.5	10.0	0.8	3W	5m - 500m
HPR 5R(S)	14.5	5.0	18.5	10.0	0.8	5W	5m - 600m
HPR 05R	26.0	5.0	12.0	10.0	0.8	5W	5m - 800m
3 Wire							
HPR 33R	26.0	5.0	13.5	10.0	0.8	3W	10m - 470m
HPR 33R(L)	26.0	8.0	13.5	10.0	0.8	5W	10m - 470m
HPR 55R	26.0	5.0	17.0	10.0	0.8	5W	10m - 470m
HPR 55R(L)	26.0	8.0	17.0	10.0	0.8	7W	10m - 470m

How to Order

HPR	05R	R10	J
Common Part	Power / Size	Resistance Value	Tolerance
HPR - Ceramic Radial Shunt	See Table Above	R005 - 5 milli ohms R47 - 470 milli ohms	J - ±5%

Low Ohmic - Current Sense Resistors

Type KNP Series

Type KNP Series



Tyco Electronics Components has utilised a unique proprietary controlled atmosphere processing technique which allows for greater precision in element formation and produces extremely stable, low resistance values. All KNP Series resistors are moulded in a high temperature silicone resin. This provides a higher dissipation or power to size ratio. It also provides superior heat, thermal slack and moisture resistance. It will not peel, flake or deteriorate with commonly used cleaning solvents including freon.

Tyco Electronics Components Low Ohm resistors are ideal for test instruments, power amplifiers, all types of current sensing applications including switching and linear power supplies. Custom design applications are also available, where volumes justify investment.

Key Features

- Flexible Manufacturing
- Tolerances from $\pm 0.1\%$ to $\pm 5\%$
- Robust Silicone Moulding
- High Power to Size Ratio
- Temp Range -55°C to 275°C
- Low Inductance < 20 Nanohenries
- R005-R10 Value Range
- Exceeds MIL-PRF-49465

Characteristics - Electrical

	KNP1A	KNP2A	KNP3	KNP5A	KNP42A	KNP47
Continuous Power Dissipation (W):	1	3	4	5	3	7
Resistance Value Range:	R005-R10	R005-R10	R005-R10	R005-R10	R005-R10	R005-R10
Dielectric Withstand (Vdc):	500	1000	1000	1000	1000	1500
Maximum Current (A):	12	20	20	26	22	22
Temperature Coefficient (ppm/ $^{\circ}\text{C}$):	± 40	± 40	± 40	± 40	± 100	± 100

Power Dissipation - The maximum power rating depends upon the amount of heat which can be transferred to the surroundings, and must be taken into account when selecting a resistor

Derating Curve

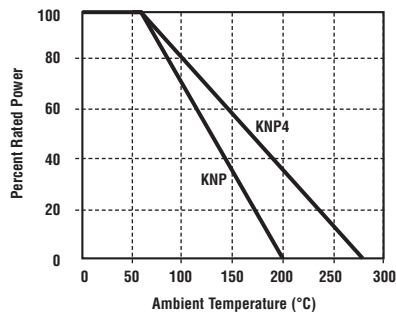

TCR vs Resistance

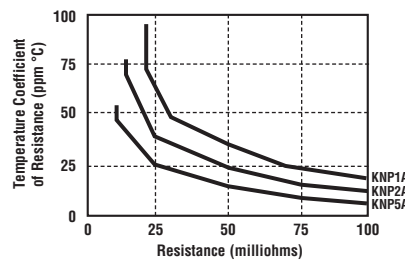

Dimensions

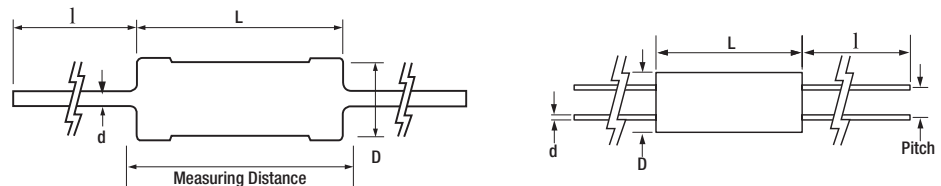

Style	L	D	Measuring Distance	I	d	Pitch
KNP1A	10.9	3.0	30.0	38.1	0.51 \pm 0.05	-
KNP2A	15.3	5.3	34.4	38.1	0.81 \pm 0.05	-
KNP5A	23.5	7.0	45.2	38.1	1.01 \pm 0.05	-
KNP4-2A	15.0	5.1	-	32.0	0.8 \pm 0.05	3.2
KNP4-7A	38.1	9.5	-	32.0	0.8 \pm 0.05	5.1

Connection points are relevant when precise values are required.

How to Order

KNP	1A	R003	J
Common Part	Rated Power	Resistance Value	Resistance Tolerance
KNP	1A - 1 Watt 2A - 3 Watt 5A - 5 Watt 4-2A - 3 Watt 4-7A - 7 Watts	R003, R01, R015, R02, R025, R03, R04, R05, R07, R08, R10	B - $\pm 0.1\%$ F - $\pm 1\%$ C - $\pm 0.25\%$ E - $\pm 3\%$ D - $\pm 0.5\%$ J - $\pm 5\%$

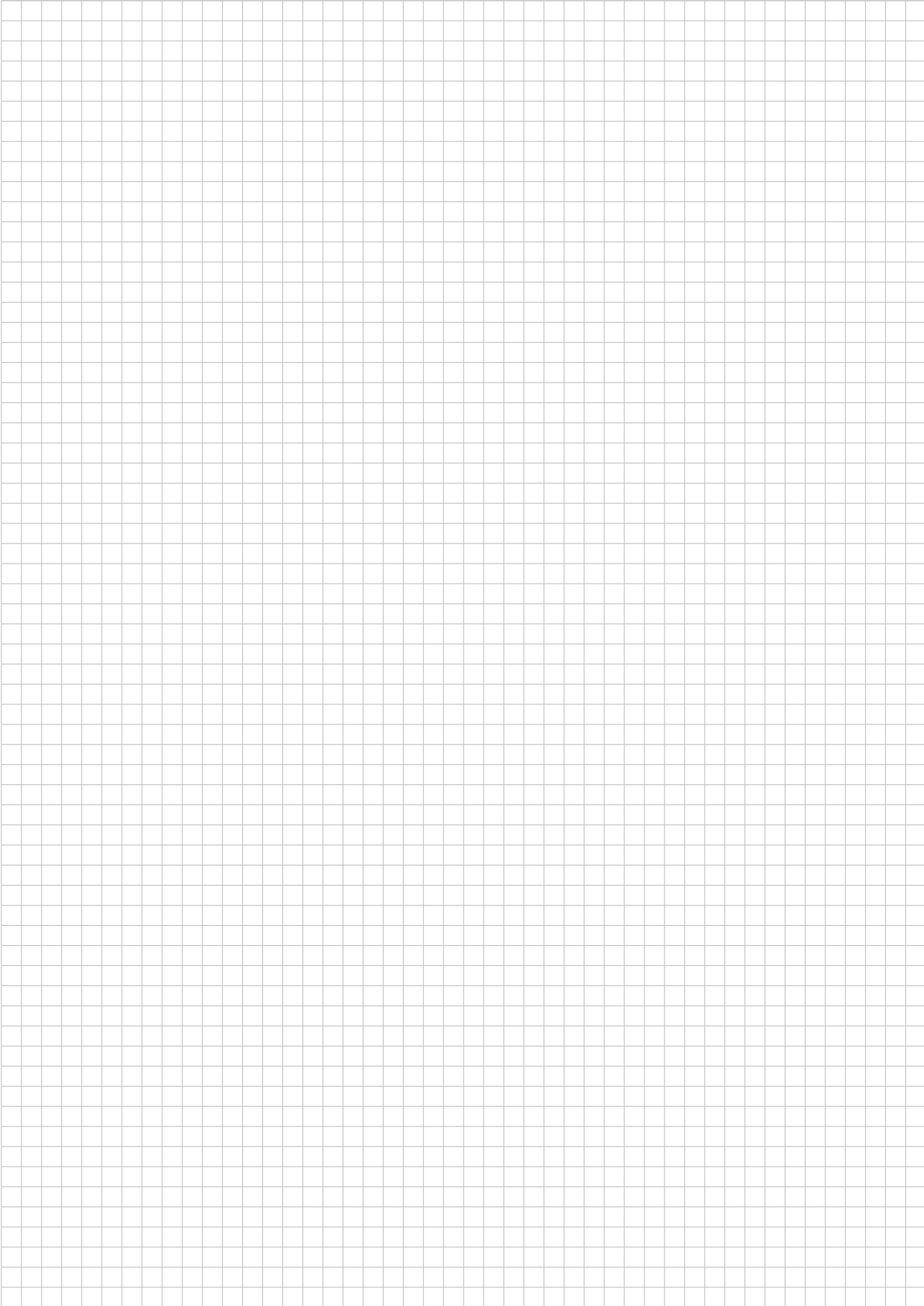

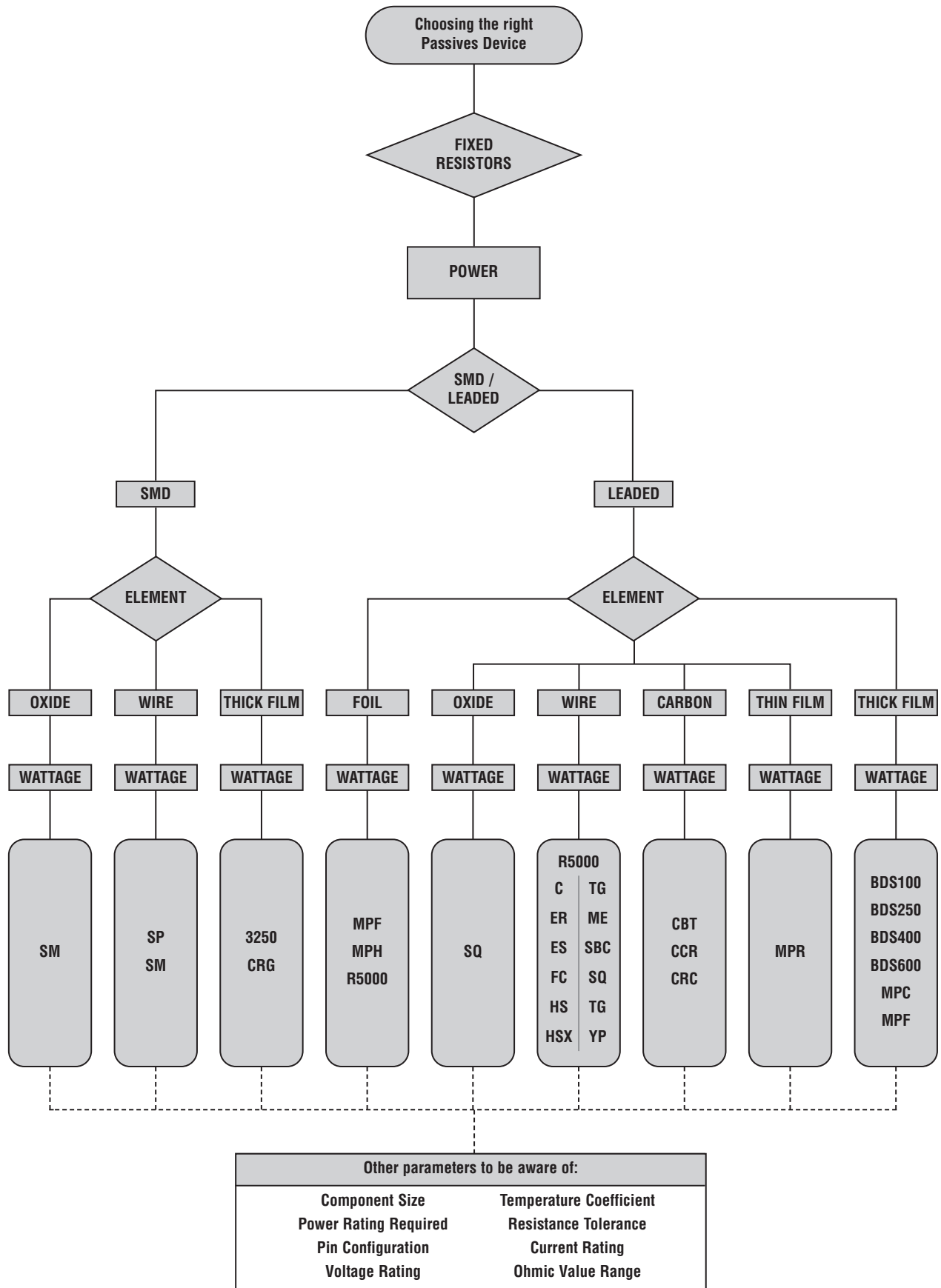

Power Resistors

Product Overview

Tyco Electronics has been manufacturing its CGS brand of power resistors for over 50 years.

We offer one of the widest ranges of power resistor styles and technologies in the world; including thick film, wire wound and foil. Within these technologies we offer standard ranges of resistors for both the low ohm and high ohm applications, with a combination of tolerances and temperature coefficients. Our standard resistor range offers resistors up to 1500 watts and selected products can withstand 12kV voltage isolation.

Our designers use only the best materials to guarantee quality and stability. Long term endurance is a standard requirement and our in-house test facility ensures that all products meet our own stringent test programmes.

We specialise in customisation of the power resistor range and have a first rate design team based in our R & D facility at Swindon, Wiltshire.

- Market leader in power technology
- Standard and custom designs available
- Wide range of technologies
- Low inductive versions available
- Diverse market applications
- High reliability materials
- In house test facility
- Highly qualified and experienced design team
- Standard products available through distribution
- Brand name CGS

Max Power Rating Watts	Ohmic Value Range	Tolerance	Technology	Finish	Family	Page
3	R10-2M0	1-5	Wire/MF	Moulded	SM	45-47
3.5	R06-45K	0.1-5	Wire	Moulded	SP	48-49
8	R20-22K	5-10	Wirewound	Silicone cement	FC	50
25	R10-1K0	5	Wirewound	Ceramic case	SQ	51-53
40	R10-22K	5-10	Wirewound	Ceramic case	SBC	54-55
14	R10-100K	1-10	Wirewound	Vit. enamel	C	56-57
14	R01-100K	0.5-5	Wirewound	Silicone	ER	58-59
300	R01-100K	0.1-10	Wirewound	Al. housed	HS	60-63
50	R05-86K	1-10	Wirewound	Al. housed	HSX	64-65
500	4R7-10K	5-10	Wirewound	Vit. enamel	ME	66-67
130	R24-100K	5	Wirewound	Glass coated	TG	68-69
10	As specified	5	Wirewound	Silicone	YP	70
1400	2R0-350R	5	Wirewound	Steel casing	MRF	71
10	1R0-200K	1-5	Thick Film	Ceramic plate	MPC	72-73
100	R47-1M0	5-10	Thick Film	Plastic moulding	BDS100	74-75
400	R47-1M0	5-10	TF/Foil	Plastic moulding	BDS250	76-77
600	R50-100K	5-10	Thick Film	Plastic moulding	BDS600	78-79
20	R22-51K	1-5	Thick Film	Plastic moulding	MPR	80-81
30	R01-50R	0.5-5	Thick Film	Plastic moulding	MPF	82-83
30	R001-10R	0.5-5	Foil	Epoxy	MPH	84-85
250	R05-10K	10	w/w or Foil	Al. housed	R5000	86-87

SMD Moulded Power Resistors

Type SM Series

Type SM Series

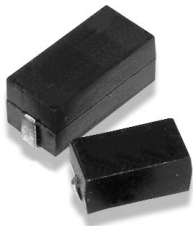

Tyco Electronics Components introduces a surface mount power resistor suited to meet today's circuit design needs. Each size offers low profile case design with flexible tinned copper terminations for reliable solder joints. All styles utilize a fully welded construction technique, unlike other designs that rely solely on tinned termination connections. These features allow the SM Series to withstand the higher temperatures associated with reflow, vapour phase, or infrared (IR) manufacturing processes without degradation.

Key Features

- Low Profile Design
- Available on Tape
- Very Wide Value Range
- Ideal for Power Circuitry
- Available in 1, 2 or 3 Watts

Characteristics - Electrical

	SM (Wire)	SM (Metal Film)
Values SMF1:	----	10R – 2M
Values SM_2:	R10 – 200R	201R – 2M
Values SM_3:	R10 – 300R	301R – 2M
Value Grid:	E24	
Resistance Tolerance:	1% or 5%	
Power Rating @ 25°C SMF1:	----	1.0 Watt
Power Rating @ 25°C SM_2:	2.0 Watts	
Power Rating @ 25°C SM_3:	3.0 Watts	
Derating:	See Curve Below	
Max Operating Voltage SMF1:	----	300 Volts
Max Operating Voltage SM_2:	300 Volts	
Max Operating Voltage SM_3:	500 Volts	

Environmental

Test	Condition	SM (Wire)	SM (Metal Film)
Temperature Coefficient of Resistance:	-55°C ~ +200°C	± 200ppm /°C	± 100ppm /°C
Short Time Overload:	5 times of rated wattage for 5 sec.	± 1%	± 0.5%
Rated Load:	Rated voltage for 30 minutes	± 1%	± 0.5%
Insulation Resistance:	500V megger.	10,000 MΩ	10,000 MΩ
Load Life:	70°C on-off cycle 1,000hrs.	± 2%	± 1%
Humidity Load Life:	40°C - 95% RH on-off cycle 500hrs.	± 2%	± 1%

Power Derating

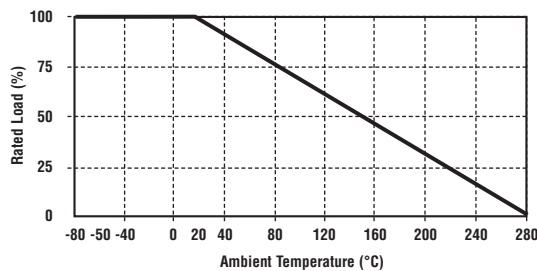

Maximum Allowable Body Temperature

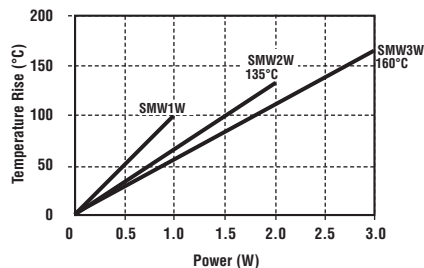

Type SM Series (continued)

Dimensions

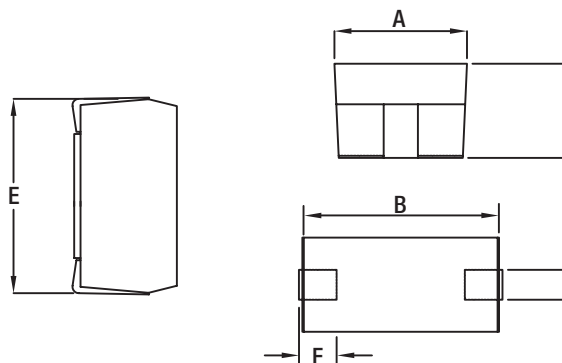

	A ±0.3	B ±0.3	C ±0.3	D ±0.3	E max	F±0.3	Qty Per Reel
SMF1	4.0	6.7	1.4	3.55	7.9	1.5	2500
SM_2	4.0	6.7	1.4	3.55	7.9	1.5	2000
SM_3	5.5	10.5	1.7	5.0	12.0	2.3	1000

How to Order

SMW	2	1R0	F	T
Common Part	Case Size	Resistance Value	Tolerance	Pack Style
SMW – Wirewound SMF – Metal Film	1 – 1 Watt 2 – 2 Watts 3 – 3 Watts	0.1 ohm (100 milli ohms) R10 1 ohm (1000 milli ohms) 1R0 100 ohm (100 ohms) 100R 1K ohm (1000 ohms) 1K0 100K ohm (100,000 ohms) 100K	J – ±5% F – ±1%	T – Taped

SMD Power Resistors

Type S Series

Type S Series



Tyco Electronics Components introduces a range of surface mount power resistors to meet today's circuit design needs. One design concept allows an engineer to choose from three styles (Lo Ohm, Power, or Ultra Precision) while staying within the new standard circuit board land pattern guidelines now accepted by the wirewound resistor industry. Each size offers low profile case design with flexible tinned copper terminations for reliable solder joints. All styles utilise a fully welded construction technique, unlike other designs that rely solely on tinned termination connections. These features allow the S Series to withstand the higher temperatures associated with reflow, vapour phase, or infrared (IR) manufacturing processes without degradation.

Key Features

- Low Profile Design
- Available on Tape (3 Reel Sizes)
- Very Wide Value Range
- Ideal for Current Sensing
- Up to 3.0 Watts Power
- High TCR Versions (to 6000ppm)
- Stable to 5ppm/°C

Characteristics - Electrical

	"SL" Lo Ohm	"SP" Power	"SU" Precision
Values S1/2:	R01 - R05	R06 - 1K4	----
Values S1:	R005 - R075	R10 - 5K0	1R0 - 300K
Values S2:	R005 - R099	R10 - 10K	1R0 - 1 Meg
Values S3:	R005 - R099	R10 - 45K	1R0 - 2 Meg
Grid:	E24	E96	E192
Resistance Tolerances:	1%, 3%, 5%.	0.1% to 5%.	0.005% to 1%.
Power Rating @ 25°C S1/2:	0.5 Watt	0.75 Watts	----
Power Rating @ 25°C S1:	1 Watt	1.5 Watt	0.125 Watts
Power Rating @ 25°C S2:	2 Watts	2.5 Watts	0.250 Watts
Power Rating @ 25°C S3:	3 Watts	3.5 Watts	0.500 Watts
Derating:	See Curve Below	See Curve Below	See Curve Below
Max. Operating Voltage S1/2:	$\sqrt{\text{Power} \times \text{Resistance}}$	33 Volts	----
Max Operating Voltage S1:	$\sqrt{\text{Power} \times \text{Resistance}}$	58 Volts	100 Volts
Max Operating Voltage S2:	$\sqrt{\text{Power} \times \text{Resistance}}$	127 Volts	300 Volts
Max Operating Voltage S3:	$\sqrt{\text{Power} \times \text{Resistance}}$	212 Volts	400 Volts
Inductance:	< 7 NanoHenries	----	----

Electrical

		Typical ΔR
Solder Immersion:	260°C for 10 seconds.	0.1%
Load Life:	2000 hours at rated power at 25°C.	0.2%
Moisture Resistance:	240 hours with humidity ranging from 80% RH to 98% RH.	0.1%
Thermal Shock:	-55°C for 15 minutes no load.	0.1%
Dielectric Withstand:	1000 Volts.	
Short Term Overload:	5 times rated power for 5 seconds	0.1%
Solderability:	95% coverage within 1/16" of contact point.	----
Flammability:	UL94V Rating.	----

Temperature Coefficient of Resistance

Range	(L) Low Ohm	(P) Power	(U) Precision
R005 - R20	<100 PPM		
R10 - R99		±30ppm	
1R0 - 10R		±20ppm	±25ppm
11R - 99R		±90ppm	±10ppm
100R and over		±50ppm	±10ppm

NB: High TCR Type Available to 6000ppm/°C

Power Derating

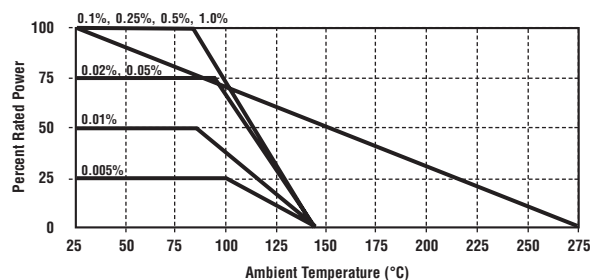

Note: U Style derates to 145°C. All others derate to 275°C

SMD Power Resistors

Type S Series (continued)

Dimensions

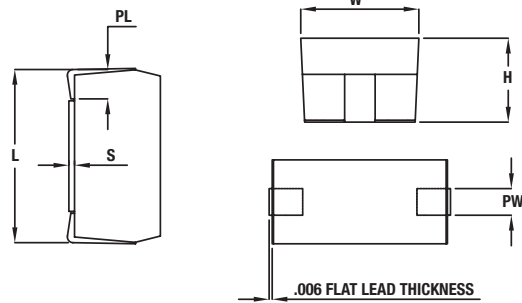

Size	Length (L)	Width (W)	Height (H)	Stand Off (S)	Pad Width (PW)	Pad Length (PL)
S 1/2	5.46	3.18	2.54	n/a	1.27	1.02
S1	6.48	3.81	2.84	0.50	1.27	1.25
S2	12.14	5.84	5.33	0.50	2.54	2.54
S3	15.24	7.00	6.48	0.50	2.29	1.27

Land Pattern

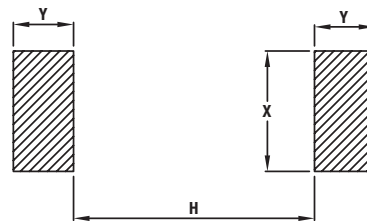

Type	H	J	X	Y
S 1/2	1.91	4.45	1.78	2.54
S1	3.43	5.97	2.03	2.54
S2	6.98	10.54	3.05	3.56
S3	10.42	14.78	2.80	3.56

Cleaning Conditions

After soldering use cleaning solvents such as chlorosen, dyefreon, suitable aqueous or semi aqueous cleaner.

Storage

To prevent damage to the electrode, be sure to observe the following cautions for storage.

- Store in 40°C maximum ambient temperature, and 70% maximum R.H.
- For maximum possible shelf life do not disturb polythene sleeve until you are ready to use.
- Store where there are no harmful gases containing sulphur or chlorine.

How to Order

S	L	1	1R0	J	T
Common Part	Resistor Type	Case Size	Resistance Value	Absolute Tol. at +25°C	Pack Style
S - Standard Part	L - Low Ohmic P - Power U - Precision	1/2 - 5.5 x 3.2 1 - 6.5 x 3.8 2 - 12.1 x 5.9 3 - 15.3 x 7.0	0.1 Ohm (100 milli ohms) R10 1 Ohm (1000 milli ohms) 1R0 1K Ohm (1000 Ohms) 1K0	K ±10% J ±5% E ±3% F ±1% D ±0.5% C ±0.25% B ±0.1% A ±0.05% Q ±0.02% T ±0.01% Z ±0.005%	L - Loose Piece R - S_1 500 pcs 7" Reel S - S_1 1000 pcs 13" Reel W - S_2 1000 pcs 13" Reel

High Power Resistors

Type FC Series

Type FC Series



This small size pluggable, high power resistor is a popular product in the Tyco Electronics Components CGS range. The resistors are wirewound on to an inert core of glass fibre. The leads and end cap assemblies are firmly crimped onto the core and winding. A particularly resilient silicone cement coating provides an insulating, humidity proof and flameproof seal. They are available in a choice of height profiles and the FCX type can be supplied with axial leads. The FC Series is widely used in monitors, power supplies, white goods and brown goods where a low cost, high power resistor is required.

Key Features

- Up to 8 Watts at 70°C
- Low Cost
- Choice of Height Profiles
- Flame Retardant
- Proven Reliability
- Resistant to PCB Solvents
- Mechanized Assembly
- Widely Available via Distribution

Characteristics - Electrical

	FC2	FC4	FC6	FC8	FC10
Watts at 70°C:	2.0	4.0	5.0	6.5	8.0
TCR400 - 50ppm°C:	R20-R30	R30-R39	R47-R56	R68-R91	R91-1R2
TCR+40/80ppm°C:	R33-47R	R47-82R	R68-120R	1R0-220R	1R3-250R
TCR-20ppm°C:	56R-3K9	100R-5K6	150R-15K	270R-20K	270R-22K

Environmental

Resistance Tolerance:	± 5% ± 10% (<1R0 = ± 10%)
Shelf Life:	ΔR 2% maximum after 3 years
Load Life:	ΔR 3% maximum after 1000 hours, rated power
Overload:	ΔR 2% maximum after 10 x rated power 5 seconds
Climatic Category:	55/200/56 ΔR 3% maximum
Maximum Continuous Operating Voltage:	√(Power x Resistance) or AC RMS
Flammability:	BS415 Clause 20:1
Marking:	Resistance Value - Resistance Tolerance - Lot no.

Power Derating Curve

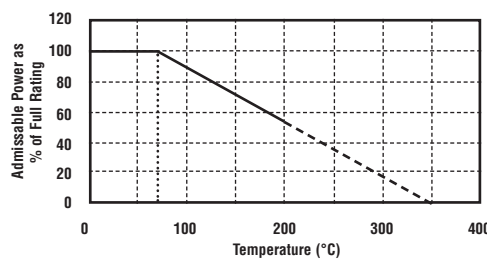

Temperature Curve

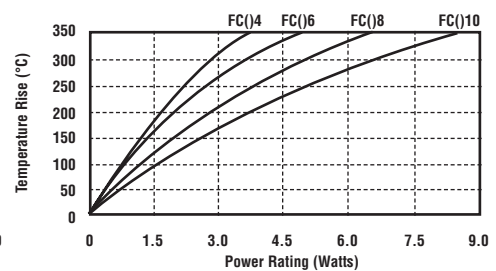

Dimensions

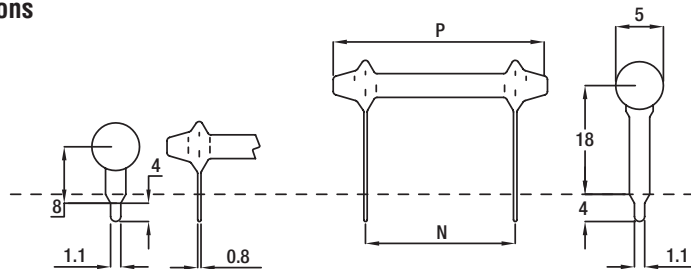

Style	N ±0.2	P (Max.)	Nom. Weight (g)
FC2	10.2	19.2	1.2
FC4	15.2	24.2	1.3
FC6	25.4	34.4	1.6
FC8	35.6	44.6	1.8
FC10	45.7	54.7	2.1

How to Order

FC	A	4	1K0	J
Common Part	Resistor Package	Power Rating @ 70°C	Resistance Value	Tolerance
FC - Fibre Core Resistor	A - Low Profile Standoff Radial B - High Profile Standoff Radial X - Axial Ledded Resistor	2 - 2 Watts 4 - 4 Watts 6 - 5 Watts 8 - 6.5 Watts 10 - 8 Watts	0.1 Ohm (100 mille Ohms) R10 1.0 Ohm (1000 mille ohms) 1R0 1K Ohm (1000 Ohms) 1K0	J - 5% K - 10% below 1R0

Type SQ Series

Type SQ Series



This flexible range of Power Wirewound Resistors either have wire or power oxide film elements. The SQ series resistors are wound or deposited on a fine non-alkali ceramic core then embodied in a ceramic case and sealed with an inorganic silica filler. This design provides a resistor with high insulation resistance, low surface temperature, excellent T.C.R., and entirely fire proof construction. These resistors are ideally suited to a range of areas where low cost, and efficient thermal performance are important design criteria. Metal film cores adjusted by laser spiral are used where the resistor value is above that suited to wire. Similar performance is obtained although short time overload is slightly derated.

Key Features

- Choice of Styles
- Bracketed Types Available
- Temp. Op. -55°C to +250°C
- Wide Value Range
- Stable TCR 300ppm/°C
- Custom Designs Welcome
- Inorganic Flame Proof Construction

Characteristics - Electrical

	Test Condition	Performance
Resistance Temperature Coeff.	-55°C ~ 155°C	± 300ppm/°C
*Short Time Overload:	10 times rated power for 5 seconds	± 2%
Rated Load:	Rated power for 30 minutes	± 1%
Voltage Withstand:	1000V AC 1 minute	no change
Insulation Resistance:	500V megger	1000 Meg
Temperature Cycle:	-30°C ~ 85°C for 5 cycles	± 1%
Load Life:	70°C on-off cycle for 1000 hours	± 5%
Moisture-proof Load Life:	40°C 95% RH on-off cycle 1000 hours	± 5%
Incombustibility:	16 times rated wattage for 5 minutes	No flame
Max. Overload Voltage:	2 times max. working voltage	
*Metal Film Elements:	Short time overload 5 times rated power, 5 seconds	

Type SQP - Horizontal

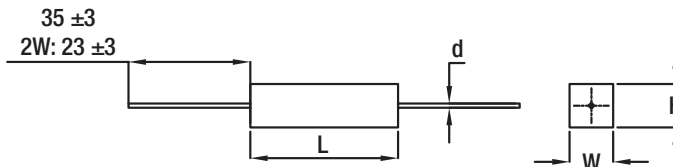

Power Rating	Dimensions					Resistance Range		Max. Working Voltage
	W ± 1	H ± 1	L ± 1.5	d ± 0.05	l ± 0.3	Wire	Metal Film	
2W	7	7	18	0.65	23	R10 - 82R	83R - 10K	150V
3W	8	8	22	0.8	35	R10 - 180R	181R - 33K	350V
5W	10	9	22	0.8	35	R10 - 180R	181R - 50K	350V
7W	10	9	35	0.8	35	R10 - 430R	431R - 50K	500V
10W	10	9	48	0.8	35	R10 - 470R	471R - 50K	750V
15W	12.5	11.5	48	0.8	35	R50 - 600R	601R - 150K	1000V
20W - 25W	14	13.5	60	0.8	35	R50 - 1K0	1.1K - 150K	1000V

Rated Continuous Working Voltage (RCWV)
RCWV: √Rated Power x Resistance Value or Maximum Working Voltage listed above whichever is lower

Type SQH - Horizontal with Solder Lugs

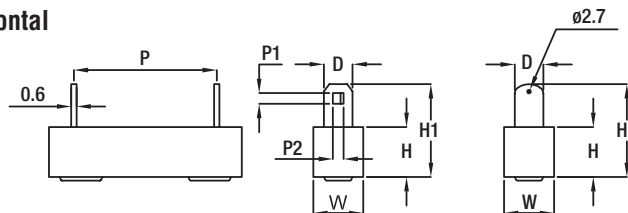

Power Rating	Dimensions						Resistance Range			
	W ± 1	H ± 1	L ± 1.5	P	H1 ± 1	D ± 0.5	P1 ± 0.2	P2 ± 0.2	Wire	Metal Film
10W	10	10	48	32 ± 1	21	5	2.5	1.7	R50 - 600R	601R - 50K
15W	12.5	11.5	48	32 ± 1	21	5	2.5	1.7	1R0 - 600R	601R - 50K
20W	14.5	13.5	60	42 ± 1	24	6	3.0	2.5	1R0 - 1K0	1K1 - 50K
30W	19	19	75	55 ± 2	31	7.5	-	-	1R0 - 2K0	-
40W	19	19	90	67 ± 2	31	7.5	-	-	1R0 - 2K0	-

Type SQB - Horizontal with Solder Lugs and Bracket

Power Rating	Dimensions			
	A ± 0.5	B ± 0.5	C ± 0.5	G ± 0.5
10W	8.0	5.0	12.0	3.0
15W	8.0	5.5	12.0	3.0
20W	8.0	5.5	12.0	3.0
30W	10.5	8.0	18.0	3.5
40W	10.5	8.0	18.0	3.5

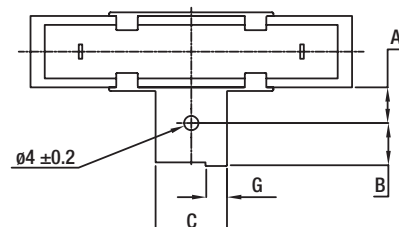

Type SQ Series (continued)

Type SQZ - Horizontal Pluggable

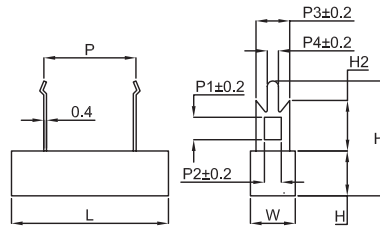

Power Rating	Dimensions										Resistance Range	
	W±1	H±1	L±1.5	P±1.5	P1	P2	P3	P4	H1±1	H2±1	Wire	Metal Film
5W	10	10	28	15	4.2	2	5	1.5	25	10.5	R10 - 130R	131R - 50K
7W	10	10	36	20	4.2	2	5	1.5	25	10.5	R10 - 430R	431R - 50K
10W	10	10	48	32	4.2	2	5	1.5	25	10.5	R20 - 470R	471R - 50K
15W	12.5	12	48	32	4.2	2	5	1.5	26	10.5	1R0 - 600R	601R - 150K
20W-25W	15	13	60	42	7	6	10	2.7	36	15.0	1R0 - 1K0	1K1 - 150K

Type SQM - Vertical

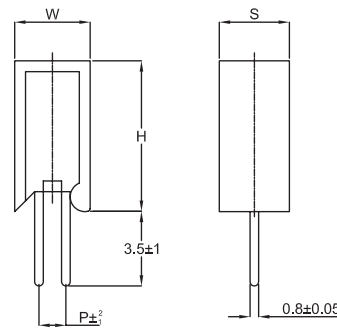

Power Rating	Dimensions				Resistance Range	
	W ± 1	H ± 1	S ± 1.5	P ± 2.0	Wire	Metal Film
2W	11	20	7	5	R10 - 82R	83R - 10K
3W	12	25	8	5	R10 - 180R	181R - 33K
5W	13	25	9	5	R10 - 180R	181R - 50K
7W	13	39	9	5	R10 - 430R	431R - 50K
10W	13	51	9	5	R10 - 470R	471R - 75K
10WS	16	35	12	7.5	R10 - 360R	361R - 100K

N.B. Custom design versions in wire at low tolerances, better T.C.R., and higher ohmic values are available to special order. Please enquire.

Type SPS - Vertical Mounting with Stabilising Bracket

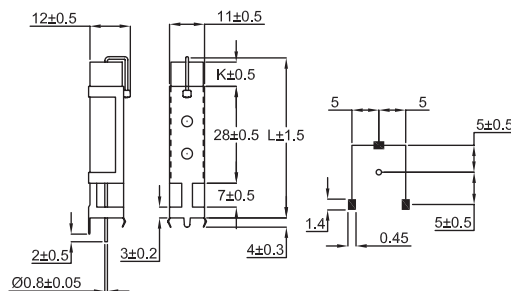

Power Rating	Dimension		Resistance Range	
	L ± 1.5	K ± 0.5	Wire	Metal Film
7W	48	8.5	R10 - 430R	431R - 50K
10W	60	20	R10 - 470R	471R - 50K

Type SQ Series (continued)

Power Derating Curve

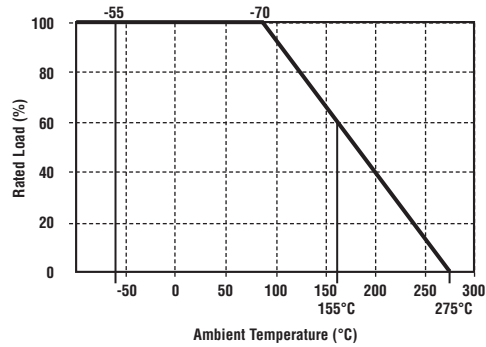

Load Against Temperature

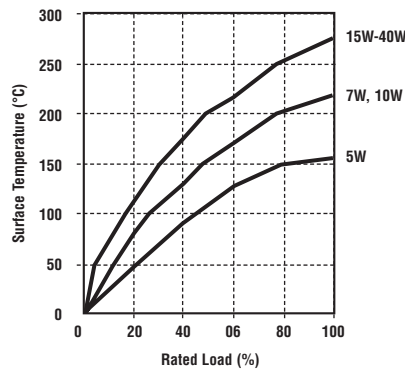

Power Resistors

How to Order

SQP	W	20	1R0	F
Common Part	Element	Rated Power	Resistance Value	Resistance Tolerance
SQP - Axial Type SQZ - Pluggable Type SQM - Vertical Type SPS - Vertical Type SQH - Horizontal Type SQB - Horizontal Type (with bracket)	W - Wire R - Metal Film	2 - 2 Watts 3 - 3 Watts 5 - 5 Watts etc	0.1 ohm (1 milliohm) R10 1 ohm (1000 milliohms) 1R0 1K ohm (1000 ohms) 1K0 1M ohm (1000000 ohms) 1M0	F - ±1% G - ±2% J - ±5% K - ±10%

High Power Resistors

Type SBC (Square Ceramic) Series

Type SBC (Square Ceramic) Series



This range of Power Wirewound Resistors is wound on continuous glass fibre elements or has a ceramic core depending on resistance value. The element is housed in a ceramic case and sealed with an inorganic silica filler. Their construction gives a resistor with high insulation resistance and low surface temperature, capable of withstanding high overload currents. These resistors are ideally suited to a variety of applications within industrial and commercial environments, where performance and reliability are of prime importance. Applications include fan force ovens, cooker hoods, power supplies and triac based speed controls. Custom Design Variants in value and style are welcomed.

Key Features

- Up to 17 Watts
- Fusible Styles
- Vertical or Axial
- Non Flammable
- Special Solvent Resistance
- Customer Specials Invited
- Widely Available from Distribution

Characteristics - Electrical

Resistance Values:	Series E24 5% E12 10% (see tables for value limits per style)
Resistance Tolerance:	±5% ±10%
Maximum Continuous Voltage:	$\sqrt{P \times R}$
Load Life:	$\Delta R < \pm 3\%$ 1000 hours at 70°C
Power Rating:	See Surface Temperature Curve (below)

Environmental and Mechanical

Temperature Coefficient of Resistance:	200ppm/°C (400ppm/°C below 18R)
Resistance to Solder Heat:	$\Delta R < 0.2\%$ (350°C for 2.5 seconds)
Voltage Coefficient of Resistance:	Negligible
Temperature Range:	0°C to 70°C
Load Stability:	$\Delta R < 5\%$ (full load at 70°C for 1000 hours)
Long Term Damp Heat:	$\Delta R < 0.2\%$ (21 days at 40°C for 93% humidity)
Shelf Life:	$\Delta R < 1.0\%$ (per 12 months)
Insulation Resistance:	> 10000M
Dielectric Strength:	2000V RMS
Lead Material:	Steel - Solder coat
Marking:	Legend mark, Manufacturer name, type, ohmic value and tolerance.

Surface Temperature Rise Curve

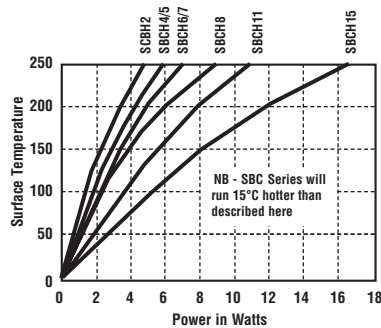

Derating Curve

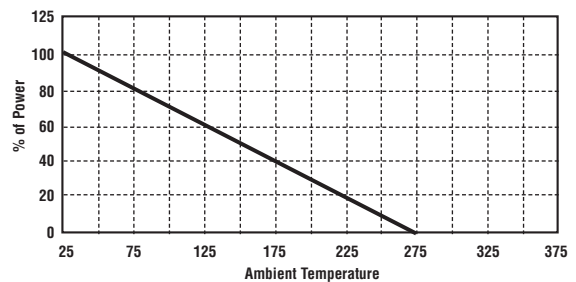

Type SBC - SBCH (Axial Power Resistor)

We offer three ceramic profiles for the main wattage sizes. These are for additional heat dissipation and vertical mounting of resistors. The suffix for each style is as follows:-

SBC Standard



SBCH 4/5/6/7

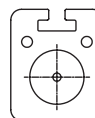

SBCH 8/11/15

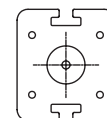

Type SBCHE (For Vertical Mounting)

We offer SBCHE Styles with one lengthened lead for vertical mounting. See additional hardware on last page.

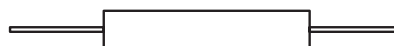

One Lead Length 20mm longer than case length. Supplied with one longer lead wrapped back in flute in ceramic.

Type SBC (Square Ceramic) Series (continued)

Type SBC - (No Flutes in Ceramic)

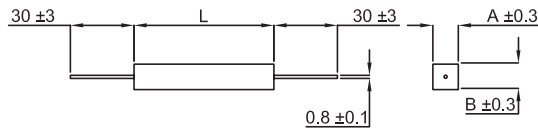

Model	Power Max	Ohmic Values		Dimensions			Weight Grams
		Min	Max	A	B	L	
SBC-2	4 W	R20	6K8	6.4	6.4	20	2.3
SBC-4	5 W	R30	10K	6.4	6.4	25	2.9
SBC-6	7 W	R47	22K	6.4	6.4	38	4.2
SBC-8	9 W	1R0	8K2	9	9	38	7.4
SBC-11	11 W	1R0	22K	9	9	50	10.8
SBC-15	17 W	1R0	22K	9	9	75	15.3

Type SBCH - (Flutes in Ceramic)

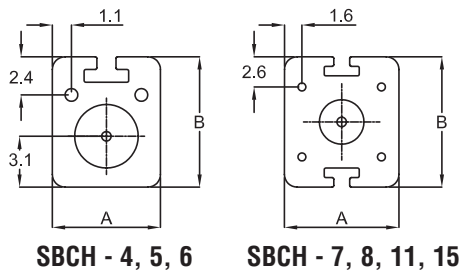

Model	Power Max	Ohmic Values		Dimensions			Weight Grams
		Min	Max	A	B	L	
SBCH-4	4 W	R20	6K8	7	8	20	2.2
SBCH-5	5 W	R30	10K	7	8	25	3.5
SBCH-6	7 W	R47	22K	7	8	38	5.0
SBCH-7	7 W	R33	10K	9	10	25	6.0
SBCH-8	9 W	1R0	8K2	9	10	38	8.0
SBCH-11	11 W	1R0	22K	9	10	50	10.0
SBCH-15	17 W	1R0	22K	9	10	75	15.0

L = Length of Ceramic Section

Type SBCLF - (Externally Fused Style)

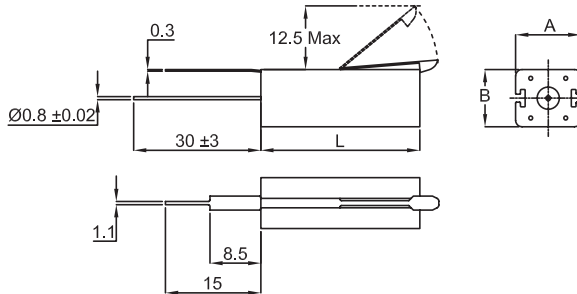

Model	Power Max	Ohmic Values		Dimensions		
		Min	Max	A	B	L
SBCLF-4	4 W	2R2	2K2	10	9	25
SBCLF-5	5.5 W	2R2	5K6	10	9	38
SBCLF-7	7 W	3R3	8K2	10	9	50
SBCLF-10	10 W	4R7	12K	10	9	75

Solder for fuse is SnPb 60:40

Type SBCV - (Vertical Mount Style)

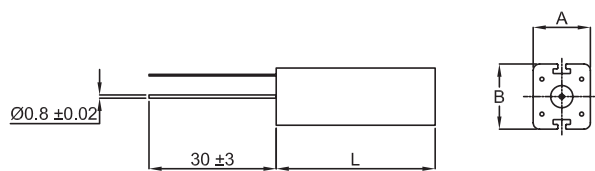

Model	Power Max	Ohmic Values		Dimensions		
		Min	Max	A	B	L
SBCV-6	7 W	R47	22K	10	9	25
SBCV-8	9 W	1R0	8K2	10	9	38
SBCV-11	11 W	1R0	22K	10	9	50
SBCV-15	17 W	1R0	22K	10	9	75

Lead drawn through hole in ceramic

How to Order

Common Part	Size	Resistance Value	Tolerance
SBCH - Axial SBCV - Vertical SBCLF - Vertical Fusible SBCHE - Axial / Vertical One Long Lead	See Relevant Table	0.2 Ohm (200 milli Ohms) R20 1 Ohm (1000 milli Ohms) 1R0 1K Ohm (1000 Ohms) 1K0	J - ±5% K - ±10%

N.B. All resistors are supplied with arklone proof seal

High Power Resistors

Type C Series

Type C Series



Tyco Electronics Components has offered the 'C' Series of Vitreous Enamelled Wirewound Resistors for more than 25 years and as a result of continuous development and investment in the latest production equipment now supplies a product with a proven record of reliability and quality. These economically priced resistors are capable of dissipating high power from a relatively small size in harsh environmental conditions. The resistors are manufactured from quality materials for optimum reliability and stability.

Key Features

- Vitreous Enamel Coated
- Quality Approved
- Up to 14 Watts Power
- All Welded Construction
- Overload 10 x 5 Seconds
- Ammo Packed or Reeled (3-7 Watt)

Characteristics - Electrical

	C3A	C7	C10	C14
Wattage at 40°C:	4	7	10	14
Ohmic Value (Min):	R10	R10	R10	R10
(Max):	10K	27K	47K	100K
Limiting Element Voltage (DC/AC RMS):	200	350	500	650
Resistance Tolerance:	10%, 5%, 2% (1% by request on a limited value range)			
Temperature Coefficient of Resistance (Ohmic Value):	Above 1R0 90ppm/°C			
Overload Resistance Change (Up to 10x rated wattage for 5 secs):	ΔR Less than 1%			
Load Life stability at Rated Wattage (Resistance Change):	1000 Hours	ΔR Less than 3%		
	8000 Hours	ΔR Less than 5%		
Shelf Life Stability (Resistance Change):	2 Years			ΔR Less than 0.25%
Power Derating:	Derate from 40°C linearly to zero at 350°C			

Environmental

Climatic Category 55/200/56:	ΔR Typically less than 1%
Solder Heat 260° for 5 Seconds:	ΔR Less than 0.1%

Surface Temperature v Power Dissipation - C3A

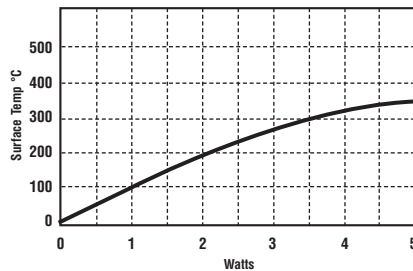

C7

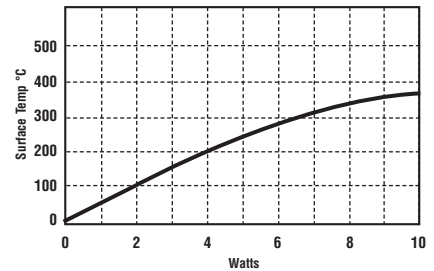

C10

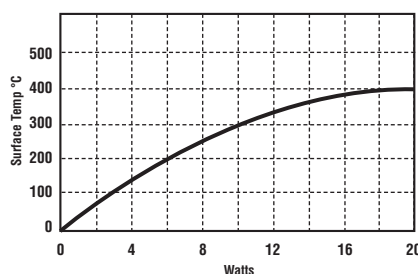

C14

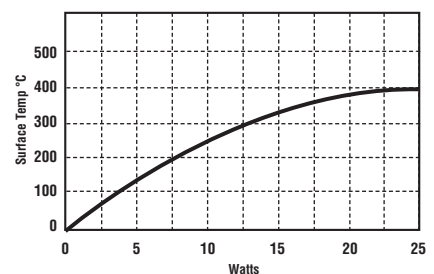

Type C Series (continued)

Dimensions

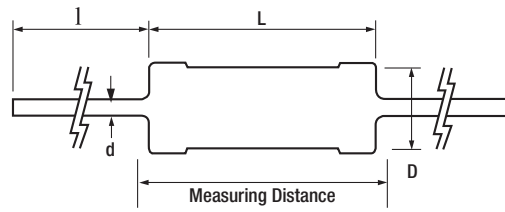

Type	L	D	d	l	Measuring Distance
C3A	13.0	5.7	0.8	35.0	30.7
C7	22.0	8.5	0.8	35.0	37.7
C10	38.1	8.5	0.8	35.0	52.8
C14	53.3	8.5	0.8	35.0	69.5

Packaging Bandolier

C10/C14 - packed in cardboard sleeves in multiples of 25.

C3A - Ammo 500 Reeled 1000

C7 - Ammo 250 Reeled 500

How to Order

C3A	680R	J	T
Common Part	Resistance Value	Tolerance	Pack Style
C3A - 3 Watt C7 - 7 Watt C10 - 10 Watt C14 - 14 Watt	0.1 ohm (100 milliohms) R10 1.0 ohm (1000 milliohms) 1R0 1K ohm (1000 ohms) 1K0	G - ±2% J - ±5% K - ±10%	R - Bandoliered Reel T - Bandoliered Ammo Pack L - Loose (C10 & C14 only)

High Power Resistors

Type ER/ERV Series

Type ER/ERV Series



A tough silicone coated power resistor. The coating and marking are resistant to Trichloroethene VG, Genklene LV Hot and Cold, Freon TE, Arklone A, Flourosil E, Freon TMS, Arklone L Hot and Cold and Arklone F Hot. If the resistor is in contact with the PCB the maximum dissipation to avoid damage to the PCB may be ascertained by reference to the hot spot temperature graph. Vertical mounting style is available. The ER series is suited to a wide range of industrial, control, medical and consumer applications.

Key Features

- High Power Dissipation
- Tough Silicone Coating
- Special Pulse Styles Available
- 0.5% Tolerance Available
- Resistant to Most Solvents
- Vertical Mount Styles Available
- Custom Designs Welcomed
- Widely Available via Distribution

Characteristics - ER Series Electrical

	ER74	ER58	ER16	ER17
Power Rating (W) at 40°C:	3W	7W	11W	14W
Power Rating (W) at 70°C:	2.5W	6W	9W	12W
Resistance Range:	R03-10K	R07-20K	R13-68K	R20-100K
Maximum Element Volts:	100V	200V	500V	750V

Characteristics - ERV Series Electrical

	ERV74	ERV58	ERV16
Power Rating (W) at 20°C*:	3W	7W	11W
Power Rating (W) at 70°C*:	1.5W	3W	5W
Resistance Range:	R10-3K9	R10-6K8	R15-27K
Maximum Element Volts:	100V	200V	500V

* When mounted in the horizontal and vertical plane only - inverted mounting may result in heat damage of the PCB
- Consult Technical Department

Environmental

Temperature Category:	-55°C to 200°C
Humidity Classification:	56 days
Standard Tolerances:	ER Series < 1 ohm ± 10% ~ > 1 ohm ± 5% ERV Series E24 - 5% ~ E12 10%
Tolerances of down to:	± 0.5% are available
Load Life Stability:	± 5%
Temperature Coefficient*:	< 1 ohm 0 ± 200ppm/°C maximum > 1 ohm 0 + 60 ppm/°C typical
*Very low temperature coefficients to ± 20ppm/°C are available to special order	
Solderability conforms to:	BS 2011 Test 2.1 Ta Solder bath method (IEC 68-2-20) Wets in < 2 seconds
Termination Robustness:	BS 2011 Test 2.1 Ua withstands 0.5 kg tensile load and double bend with 0.25 kg load
Endurance - 1000hrs @ 200°C:	ΔR -0 +2%
Overload:	10 time rated dissipation for 5 seconds ΔR ± 0.5%
Humidity:	56 days/95% R.H./ +_45°C -0 +5%
Temperature Rapid Change:	ΔR ± 0.03%

Power Ratings Dissipation / Ambient Temperature

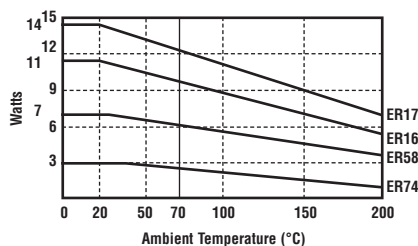

Power Ratings Hot Spot Temperature @ 40°C

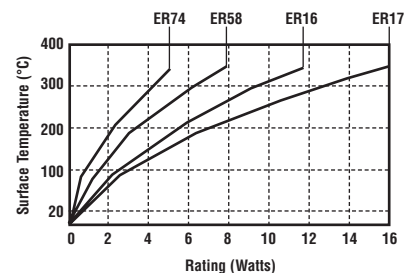

Power Ratings (continued)

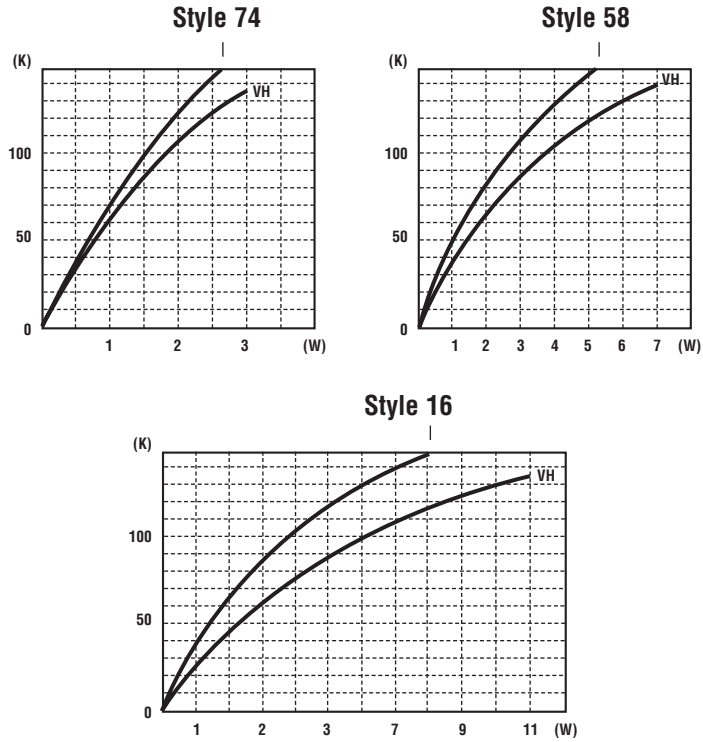

Dimensions

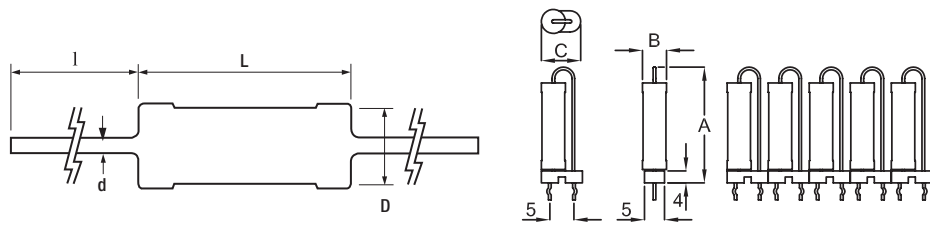

Type	L	D	I	d
ER74	13.5	6.0	38.0	0.8
ER58	22.2	8.0	38.0	0.8
ER16	38.1	8.0	38.0	0.8
ER17	53.5	8.0	38.0	0.8

Type	A	B	C
ERV74	19.0	5.6	9.7
ERV58	29.0	8.0	10.6
ERV16	43.0	8.0	10.6

- Resistance measured 6mm either side of body.
- Supplied in standard packs in arrays of 5 resistors with snap links for handling.

How to Order

ER	74	100R	J	T
Common Part	Power Rating at 40°C	Resistance Value	Tolerance	Pack Style
ER - Silicone Coated	74 - 3W	0.1 ohm (100 milli ohms) R10	D - ±0.5%	T - Ammo Packed
ERV - Silicone Coated Vertical Mount	58 - 7W	1 ohm (1000 milli ohms) 1R0	F - ±1%	6P - 6mm Boot (Boots on ERV Only)
	16 - 11W	1K ohm (1000 ohms) 1K0	G - ±2%	
	17 - 14W		J - ±5%	
	ER17 not available in ERV		K - ±10%	

Aluminium Housed Power Resistors

Type HS Series

Type HS Series



Tyco Electronics Components is the leading European supplier of standard and custom designed aluminium housed resistors for general-purpose use, power supplies, power generation and the traction industry. The HS is a range of extremely stable, high quality wire wound resistors capable of dissipating high power in a limited space with relatively low surface temperature. The power is rapidly dissipated as heat through the aluminium housing to a specified heatsink.

The resistors are made from quality materials for optimum reliability and stability. Tyco Electronics Components can test resistors to conform to relevant international, MIL or customer specifications.

Tyco Electronics Components is happy to advise on the use of resistors for pulse applications and to supply information for high voltage use and low-ohmic value, alternative mountings and termination type.

Key Features

- **Established product with proven reliability**
 - **Leading the way with over 50 years of design and manufacturing experience**
- **5 Watts to 300 Watts (500 Watt and 1000 Watt versions available)**
 - **Largest range on the market**
- **Versatile product**
 - **Bench mark in every industry**
- **Custom designs**
 - **Windings, terminations, mountings - We have a solution for your application**
- **Low resistance, low inductance and higher voltage versions available**
 - **Specialising the standard**

Characteristics - Electrical HSA & HSC - 5 Watts to 75 Watts

	HSA5	HSA10	HSA25	HSA50	HSC75
Dissipation @ 25°C with Heatsink (Watts):	10	16	25	50	75
Without Heatsink:	5.5	8	12.5	20	45
Ohmic Value Min (Ohms):	R01	R01	R01	R01	R05
Max:	10K	15K	36K	100K	50K
Maximum Working Voltage (DC or ACrms) Volts:	160	265	550	1250	1400
Dielectric Strength (AC Peak) Volts:	1400	1400	2500	2500	5000
Stability (% resistance change, 1000 hours) (%):	1	1	1	1	2
Standard Heatsink - Area (mm²):	41500	41500	53500	53500	99500
Thickness (mm):	1	1	1	1	3
Number of Mounting Holes:	2 hole	2 hole	2 hole	2 hole	4 hole

Characteristics - Electrical HSC - 100 Watts to 300 Watts

	HSC100	HSC150	HSC200	HSC250	HSC300
Dissipation @ 25°C with Heatsink (Watts):	100	150	200	250	300
Without Heatsink:	50	55	50	60	75
Ohmic Value Min (Ohms):	R05	R10	R10	R10	R10
Max:	100K	100K	50K	68K	82K
Maximum Working Voltage (DC or ACrms) Volts:	1900	2500	1900	2200	2500
Dielectric Strength (AC Peak) Volts:	5000	5000	5600	5600	5600
Stability (% resistance change, 1000 hours) (%):	2	2	3	3	3
Standard Heatsink - Area (mm²):	99500	99500	375000	476500	578000
Thickness (mm):	3	3	3	3	3
Number of Mounting Holes:	4 hole	4 hole	6 hole	6 hole	6 hole

Electrical

Long Term Stability:	For improvements in long-term stability, resistors must be derated as follows; for 50% of stated ΔR maximum dissipation must not exceed 70% of rating; for 25% of stated ΔR maximum, dissipation must not exceed 50% of rating
Insulation Resistance:	Dry: 10,000M Ω minimum. After moisture test: 1000M Ω minimum.
Heat Dissipation:	Although the use of proprietary heat sinks with lower thermal resistance is acceptable, up rating is not recommended. The use of proprietary heat sink compound to improve thermal conductivity is recommended for optimum performance of all sizes but essential for HSC200, HSC250 & HSC300
Specification:	Temperature coefficient below 100R, 50ppm/°C Temperature coefficient above 100R, 30ppm/°C Tolerance, 5% standard: 10%, 3%, 2%, 0.5% & 0.25% available Tolerance for values below R10, 10% standard

Applications

- **Braking Resistor**
- **Balancing Resistor**
- **Capacitor Charging & Discharging**
- **Crowbar**
- **Filter**
- **Electrical Machinery general use**
- **Available through Distribution**

Type HS Series (continued)

**Product Specifications -
HSA5 - HSC150**

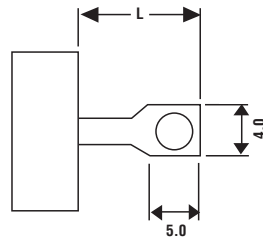

Type	L
HSA5, 10	7
HSA25, 50	10
HSA75, 100, 150	8

HSC200 - HSC300

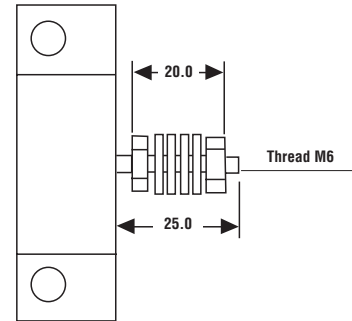

**Dimensions -
HSA5 - HSA50**

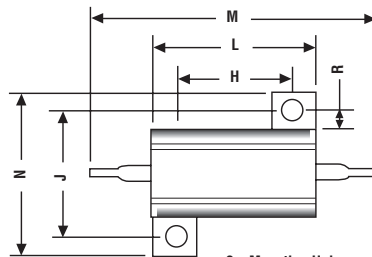

2 x Mounting Hole
HSA5 - 2.4mm
HSA10 - 2.4mm
HSA25 - 3.3mm
HSA50 - 3.3mm

HSC75 - HSC150

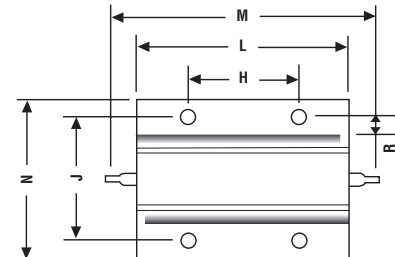

4 x Mounting Hole
HSC75 - 4.4mm
HSC100 - 4.4mm
HSC150 - 4.4mm

HSC200+

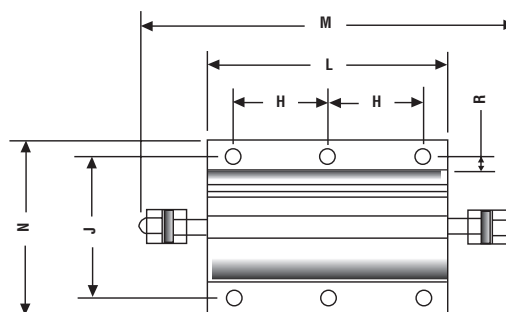

6 x Mounting Hole
HSC200 - 5.3mm
HSC250 - 5.3mm
HSC300 - 6.5mm

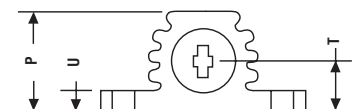

Type	H±0.3	J±0.3	K±0.2	L Max	M Max	N Max	P Max	R Min	T±0.5	U Max
HSA5	11.3	12.4	2.4	17.0	30.0	17.0	9.0	1.9	3.4	2.5
HSA10	14.3	15.9	2.4	21.0	36.5	21.0	11.0	1.9	5.2	3.2
HSA25	18.3	19.8	3.3	29.0	51.8	28.0	15.0	2.8	7.2	3.2
HSA50	39.7	21.4	3.3	51.0	72.5	30.0	17.0	2.8	7.9	3.2
HSC75	29.0	37.0	4.4	49.0	71.0	47.5	26.0	5.0	11.5	3.5
HSC100	35.0	37.0	4.4	65.5	87.5	47.5	26.0	5.0	11.5	3.5
HSC150	58.0	37.0	4.4	98.0	122.0	47.5	26.0	5.0	11.5	3.5
HSC200	35.0	57.2	5.3	90.0	143.0	73.0	45.0	5.6	22.2	6.75
HSC250	44.5	57.2	5.3	109.0	163.0	73.0	45.0	5.6	22.2	6.75
HSC300	52.0	59.0	6.5	128.0	180.0	73.0	45.0	6.0	22.2	6.75

Derating Curve HSA5 to HSA50

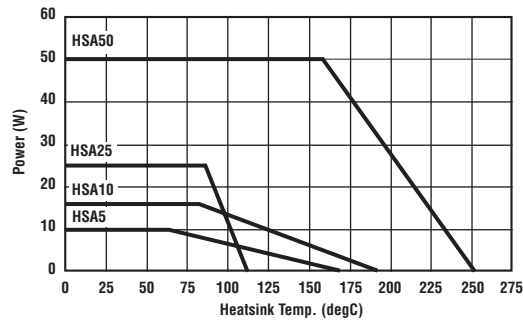

Derating Curve HSC75 to HSC300

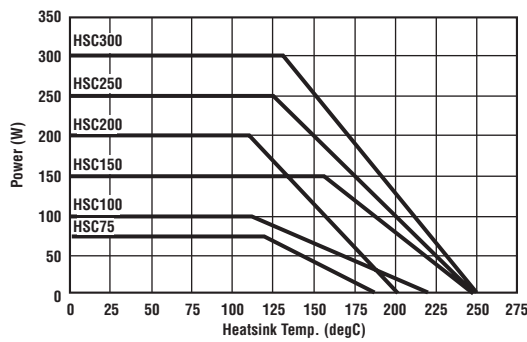

Pulse Energy HSA5 to HSC75

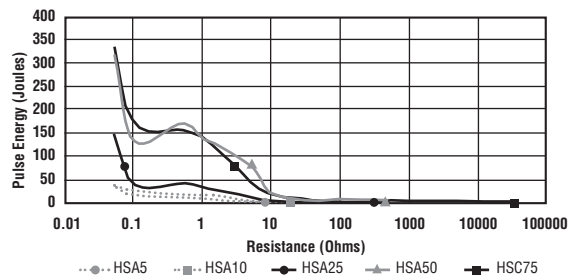

Pulse Energy HSC100 to HSC300

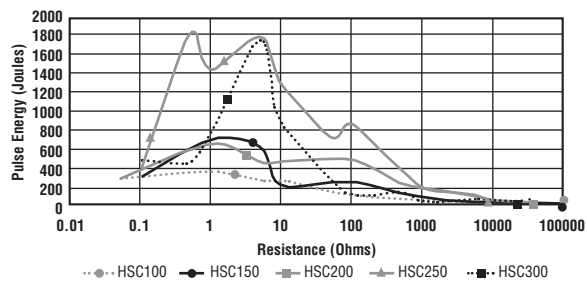

Power Overload

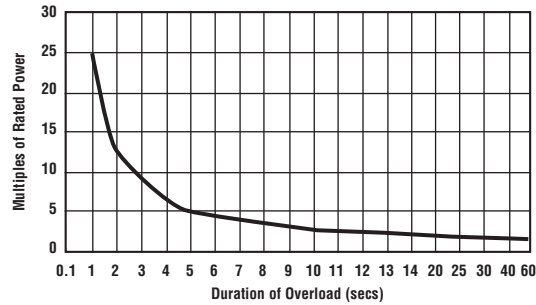

This graph indicates the amount that the rated power (at 20°C) of the standard HS Series resistor may be increased for overloads of 100mS to 60S

Surface Temperature Rise

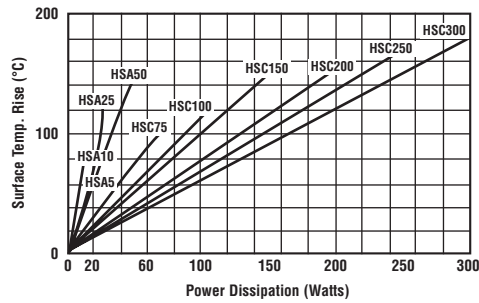

For resistor mounted on standard heatsink, related to power dissipation

How to Order

HS	A	50	680R	J
Common Part	Mounting Style	Power Rating	Resistance Value	Tolerance
HS - Standard NHS - Low Inductance	A - Single Opposing mounting Feet B - Flange One Side C - Flange Two Sides	10 Watt = HSA5 16 Watt = HSA10 25 Watt = HSA25 50 Watt = HSA50 75 Watt = HSA75 etc	0.1ohm (100 mille ohms) R10 1ohm (1000 mille ohms) 1R0 1K (1000 ohms) 1K0	F - 1% G - 2% E - 3% J - 5% K - 10%

Aluminium Housed Power Resistors

Type HSX Series

Type HSX Series

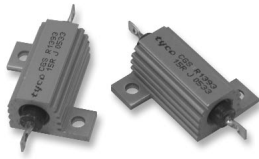

Tyco Electronics Components is the leading European supplier of standard and custom designed aluminium housed resistors for general-purpose use, power supplies, power generation and the traction industry. The HSX range consists of extremely stable, high quality wire wound resistors capable of dissipating high power in a limited space with relatively low surface temperatures. The power is rapidly dissipated as heat through the aluminium housing to a specified heatsink. The HSX offers increased creep distance by virtue of a remodelled and extended nose cone.

The resistors are made from quality materials for optimum reliability and stability. Tyco Electronics Components can test resistors to conform to relevant international, MIL or customer specifications.

Tyco Electronics Components is happy to advise on the use of resistors for pulse applications and to supply information for high voltage use and low-ohmic value, alternative mountings and termination type.

Key Features

- **10mm Creep Distance**
 - High voltage performance up to 3.5kV
- **Broad Range of Options and Custom Design Capability**
 - The solution for your application
- **Special Pulse Variants Available**
 - Maximised wire wound element technology for high pulse energy absorption
- **Wide Resistance range: 0.5Ω– 86kΩ**
 - Coupled with 1% tolerance gives ultimate design flexibility
- **Proven Reliability**
 - Benefits from over 50 years of HS resistor design and manufacture

Characteristics - Electrical

	HSX25	HSX50	HSX50+
Dissipation @ 25°C with Heatsink (Watts):	25	50	50
Without Heatsink:	12.5	20	20
Ohmic Value Min (Ohms):	R05	R05	R05
Max:	36K	86K	86K
Maximum Working Voltage (DC or ACrms) Volts:	500V	1250V	1250V
Dielectric Strength (AC peak) Volts:	3.5kV	3.5kV	3.5kV
Insulation Resistance @ 500V (Ohms):	>10GΩ	>10GΩ	>10GΩ
Creep Distance (mm):	5	5	10
Stability (% resistance change, 2000 hours) (%):	≤ 2%	≤ 2%	≤ 2%
Temperature Coefficient ppm/°C:	<±50ppm/°C	<±50ppm/°C	<±50ppm/°C
Environmental Category:	-55/200/56	-55/200/56	-55/200/56
Long Term Stability:	For improvements in long-term stability, resistors must be derated as follows; for 50% of stated ΔR maximum dissipation must not exceed 70% of rating; for 25% of stated ΔR maximum, dissipation must not exceed 50% of rating		
Insulation Resistance:	Dry: 10GΩ minimum. After moisture test: 1GΩ minimum.		
Heat Dissipation:	Although the use of proprietary heat sinks with lower thermal resistance is acceptable, up rating is not recommended. The use of proprietary heat sink compound to improve thermal conductivity is recommended for optimum performance.		
Specification:	Temperature coefficient below 100R, 50ppm/°C Temperature coefficient above 100R, 30ppm/°C Tolerance, 5% standard: 10%, 3%, 2%, 0.5% & 0.25% available.		

Dimensions

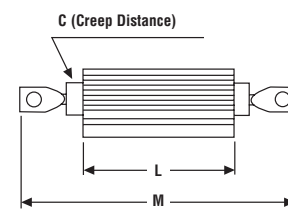
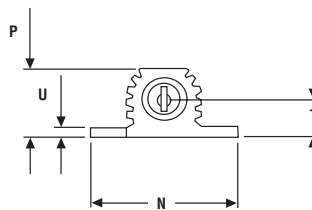
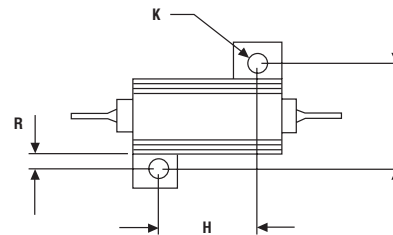

Type	C Min	H±0.3	J±0.3	K±0.3	L Max	M Max	N Max	P Max	R Min	T±0.5	U Max
HSX25	5	18.3	19.8	3.3	29.0	51.8	28.0	15.0	2.8	7.2	3.2
HSX50	5	39.7	21.4	3.3	51.0	72.5	30.0	17.0	2.8	7.9	3.2
HSX50+	10	39.7	21.4	3.3	51.0	72.5	30.0	17.0	2.8	7.9	3.2

Applications

- High Voltage
- Filter
- Crowbar
- Braking
- Balancing
- Capacitor Charging & Discharging
- Electrical Machinery

Type HSX Series (continued)

Derating Curve

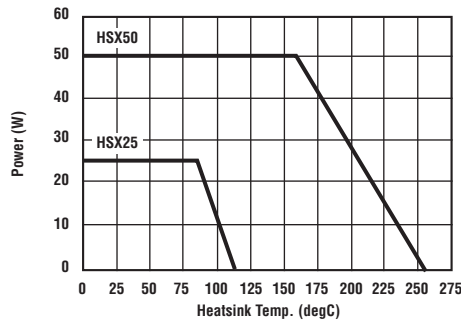

Pulse Energy

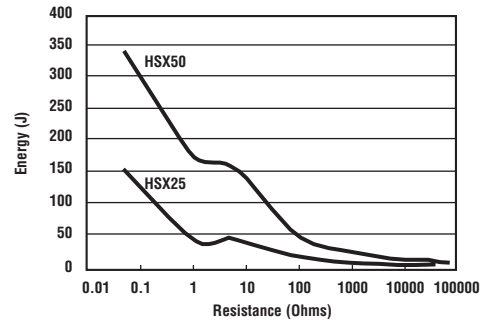

Power Overload

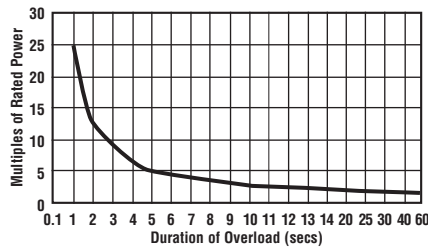

This graph indicates the amount that the rated power (at 20°C) of the standard HSX Series resistor may be increased for overloads of 100mS to 60S

Surface Temperature Rise

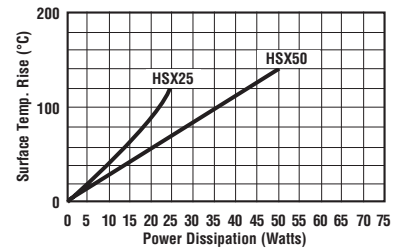

For resistor mounted on standard heatsink, related to power dissipation

How to Order

HSX	50	680R	J
Common Part	Power Rating	Resistance Value	Tolerance
HSX - Aluminium Housed Power Resistor	250 500 750 1000	0.1ohm (100mΩ) R10 1 ohm (1000mΩ) 1R0 1K (1000Ω) 1K0	F - 1% G - 2% E - 3% J - 5% K - 10%

Type ME Series

Type ME Series



Tyco Electronics Components is a leading supplier of standard and custom-designed vitreous enamel power resistors for industrial, control, and general-purpose applications.

The ME Range of wire and tape wound tubular resistors is designed for maximum power density (in free air), and a durable vitreous enamel coating provides a reliable and resilient, high power solution.

Resistors are supplied with flexible wire terminations or tags (for screw, solder or use with Faston connectors). Options include low inductance winding, different tube sizes for a given power rating, and a range of mechanical packages including horizontal or vertical mounting.

Tyco Electronics Components is happy to advise on the use of resistors for pulse applications and to supply information for high voltage use, low-ohmic values, alternative mountings and termination types in addition to testing resistors to conform to relevant international, MIL or customer specifications.

Key Features

- **High Power Dissipation in Free Air**
 - No need for a heatsink
- **Overload 15 Times Rated Power**
 - A compact and cost effective solution
- **Mechanically Stable in Demanding Environments**
 - Vitreous Enamel coating resists impact and temperatures of 400°C
- **Broad Range of Options: Adjustable Resistance, Low TCR, Custom Design Capability**
 - Gives ultimate design flexibility
- **Established Product with Proven Reliability**
 - Consistent high quality at a competitive price
- **48 Standard Products from 30W to 625W**
 - The solution for your application

Characteristics - Electrical

Power Reference - Power at 360°C (W)								
	30		40		45		60	
Type:	Power at 380°C	R Values	Power at 380°C	R Values	Power at 380°C	R Values	Power at 380°C	R Values
ME (Standard):	35W	2R2-5K0	65W	4R7-10K	65	4R7-10K	70W	4R7-10K
MA (Adjustable):					—	—		
MF (Ferrule Ends):					65	4R7-10K		
MD (Ferrule Dead End):					65	4R7-10K		
MT (Tape Wound):	44W	R02-2R0	80W	R15-4R5	80W	R20-4R5	90W	R20-4R5

Power Reference - Power at 360°C (W)								
	90		130		150		180	
Type:	Power at 380°C	R Values	Power at 380°C	R Values	Power at 380°C	R Values	Power at 380°C	R Values
ME (Standard):	125W	10R-22K	175W	10R-22K	185W	12R-22K	230W	22R-22K
MA (Adjustable):					—	—		
MF (Ferrule Ends):					185W	12R-22K		
MD (Ferrule Dead End):					185W	12R-22K		
MT (Tape Wound):	185W	R30-9R0	215W	R70-9R0	245W	R80-10R	285W	1R0-20R

Power Reference - Power at 360°C (W)						
	220		320		380	
Type:	Power at 380°C	R Values	Power at 380°C	R Values	Power at 380°C	R Values
ME (Standard):	320W	22R-22K	450W	33R-22K	500W	47R-22K
MA (Adjustable):					—	—
MF (Ferrule Ends):					—	—
MD (Ferrule Dead End):					—	—
MT (Tape Wound):	400W	1R0-20R	560W	1R5-30R	625W	1R5-30R

Damp Heat:	56 days 90 – 95% ΔR < ± 2%
Storage Temperature:	-55°C to +200°C
Tolerance:	±5% ±10%

Applications

- Braking
- Crowbar
- In-rush Limiting
- Balancing
- Capacitor Charging & Discharging
- Filter
- Electrical Machinery

Dimensions - MF & MD Type

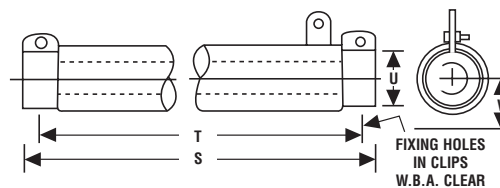

MF & MD Type										
	30	40	45	60L	60S	90L	90S	130	180	220
S	76	127	83	121	102	197	133	184	248	298
T	65	116	70	108	90	184	121	171	235	286
U	14	14	27	21	27	21	27	27	27	27
V	19	19	32	22	32	22	32	32	32	32
W	4BA	4BA	0BA	2BA	0BA	2BA	0BA	0BA	0BA	0BA

Type ME Series (continued)

Dimensions - ME, MA & MT* Type

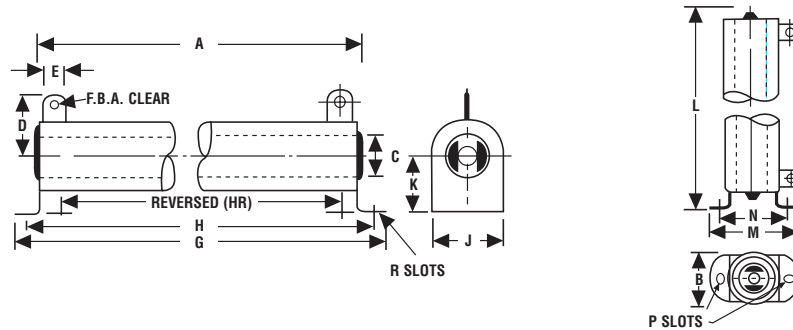

ME, MA & MT* Type													
	30	40	45	60L	60S	90L	90S	130	150	180	220	320	380
A	51	102	51	89	70	165	102	152	178	216	2667	267	305
B*	19	19	32	32	32	22	32	32	32	32	32	45	45
C	9.5	9.5	19	12.6	19	12.6	19	19	19	19	19	28	28
D	25	25	37	30	37	30	37	37	37	37	37	43	43
E	6.3	6.3	6.3	6.3	6.3	6.3	9.5	9.5	9.5	9.5	9.5	9.5	9.5
F	4BA	4BA	4BA	4BA	4BA	4BA	2BA	2BA	2BA	2BA	2BA	2BA	2BA
G	72	123	91	117	110	193	142	192	218	256	307	318	356
H	62	113	75	103	94	179	126	176	202	240	291	291	327
HR	42	93	30	77	48	153	80	130	156	194	245	248	286
J	16	16	28	20	28	20	28	28	28	28	28	44	44
K	20	20	27	27	27	27	27	27	27	27	27	51	51
L	64	114	64	102	83	178	114	165	119	229	279	-	-
M	38	38	54	45	54	45	54	54	54	54	54	-	-
N	25	25	41	32	41	32	41	41	41	41	41	-	-
P	4 x 6	4 x 6	5 x 8	4 x 6	5 x 8	4 x 6	5 x 8	5 x 8	5 x 8	5 x 8	5 x 8	-	-
R	4 x 6	4 x 6	5 x 13	5 x 8	5 x 13	5 x 8	5 x 13	5 x 13	5 x 13	5 x 13	5 x 13	-	-

* For MT type, dimension B may increase by up to 10mm due to tape width.

Power Resistors

Derating Curve

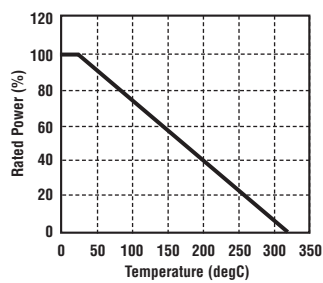

Surface Temperature Rise in Free Air

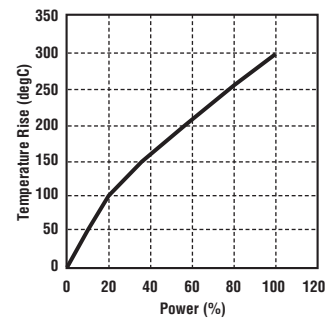

How to Order

ME	-	30	-	1K0	J	H
Common Part	Inductance	Power Rating @ 360°C	Tube Description	Resistance Value	Tolerance	Mounting System
ME – Standard MT – Tape Wound MA – Adjustable MF – Ferrule Ends MD – Ferrule Dead End	-- Standard N – Low Inductance	30W – 380W (See Table)	-- Standard S – Short Profile L – Long Profile	0.1ohm (100mΩ) R10 1 ohm (1000mΩ) 1R0 1K (1000Ω) 1K0	J – ± 5% K – ±10%	-- Resistor only H – Hor./Ver. or Bolt-on V-Mount TB – Through Bolt only C – Cradle for Ferrule End

Glass Bond Coated Power Resistors

Type TG Series

Type TG Series



Tyco Electronics Components is a leading European supplier of standard and custom designed glass-coated power resistors for industrial, control, and general-purpose applications.

The TG is a glass-coated power resistor designed for maximum power density (in free air), and offers a reliable low cost, high power solution. The highly refractory glass bond coat resists impact and does not deteriorate under power overload and the high quality construction offers optimum reliability and stability. Tyco Electronics Components can test resistors to conform to customer specifications.

A large selection of tube styles, diameters and mounting feet are available to meet every space and package requirement. Tyco Electronics Components is happy to advise on the use of resistors for pulse applications and to supply information for high voltage use, low-ohmic values, alternative mountings and termination types.

Key Features

- **High Power Dissipation in Free Air**
 - No need for a heatsink
- **Mechanically Stable in Demanding Environments**
 - Durable glass bond coating resists impact and temperatures of 400°C
- **Broad Range of Options: Terminal styles, Silicon Coating, Low TCR, Custom Design Capability.**
 - Gives ultimate design flexibility
- **Established Product with Proven Reliability**
 - Tyco Electronics quality at a highly competitive price
- **A range of 34 Standard Products from 8.5W to 293W**
 - Specify the optimum configuration for your application

Characteristics - Electrical

TG Style	Power @ 20°C Watts Hotspot 400°C	Ohmic Range	Length		Code
			Inches	mm	
Style Code 3	20	R24 - 3K0	1.5	38.1	TG3 -1
	29	R39 - 6K2	2.0	50.8	TG3 -2
	39	R51 - 7K5	2.5	63.5	TG3 -3
	49	R68 - 9K1	3.0	76.2	TG3 -4
	58	1R0 - 1K5	4.0	101.6	TG3 -5
	88	1R0 - 18K	5.0	127.0	TG3 -6
Style Code 5	18	R30 - 4K3	1.3	33.3	TG5 -1
	33	R62 - 8K2	2.0	50.8	TG5 -2
	44	R91 - 10K	2.5	63.5	TG5 -3
	53	1R0 - 11K	2.9	73.0	TG5 -4
	31	R62 - 12K	1.8	44.5	TG6 -1
Style Code 6	58	1R0 - 22K	2.9	73.0	TG6 -2
	62	1R0 - 24K	3.0	76.2	TG6 -3
	74	1R0 - 30K	3.5	89.0	TG6 -4
	87	1R0 - 36K	4.0	101.6	TG6 -5
	99	1R0 - 39K	4.5	114.3	TG6 -6
	111	1R0 - 47K	5.0	127.0	TG6 -7
Style Code 8	124	1R0 - 51K	5.5	139.7	TG6 -8
	148	1R0 - 62K	6.5	165.1	TG6 -9
	103	1R0 - 36K	4.0	101.6	TG8 -1
	132	1R0 - 43K	5.0	127.0	TG8 -2
	161	1R0 - 51K	6.0	152.4	TG8 -3
Style Code 10 Oval	234	1R0 - 82K	8.5	216.0	TG8 -4
	293	1R0 - 100K	10.5	266.7	TG8 -5
	22	1R0 - 2K0	1.0	25.4	TG10 -1
	30	3R6 - 3K0	1.3	33.3	TG10 -2
	45	10R - 5K1	2.0	50.8	TG10 -3
	57	15R - 6K8	2.5	63.5	TG10 -4
	67	18R - 8K2	3.0	76.2	TG10 -5
	79	22R - 10K	3.5	89.0	TG10 -6
	90	24R - 11K	4.0	101.6	TG10 -7
	100	27R - 12K	4.5	114.3	TG10 -8
110	30R - 13K	5.0	127.0	TG10 -9	
130	36R - 18K	6.0	152.4	TG10 -0	

Long Term Stability: For improvements in long-term stability, resistors must be derated as follows; for 50% of stated ΔR maximum dissipation must not exceed 70% of rating; for 25% of stated ΔR maximum, dissipation must not exceed 50% of rating.

Specification: Maximum Temperature coefficient: 200ppm/oC
 Typical Temperature coefficient: 60ppm/oC
 Special Low TCR version: 20ppm/oC
 Tolerance: 5% standard. 1%, 10% available.

Applications

- Braking
- Balancing
- Filter
- Crowbar
- Capacitor Charging & Discharging
- Electrical Machinery
- Inrush Limiting

Dimensions - Style 10 Oval

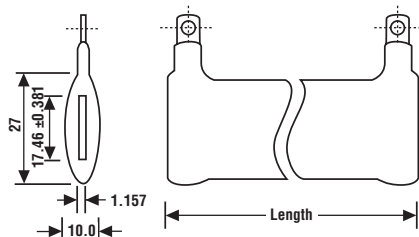

Styles 3, 5, 6, 8

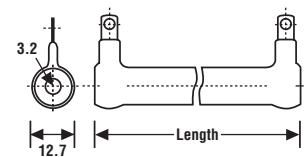

Style	d	D
3	3.2	12.7
5	9.5	19.1
6	12.7	22.2
8	15.9	30.2

Derating Curve

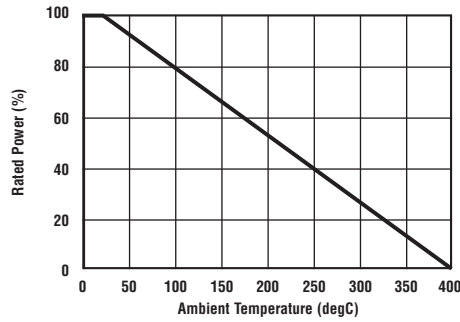

Pulse Energy - TG3

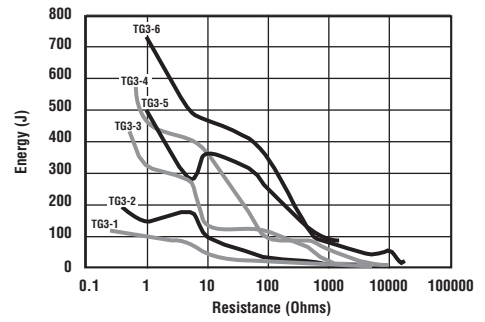

Pulse Energy - TG5

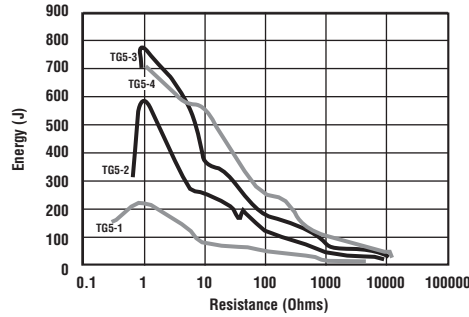

Pulse Energy - TG6

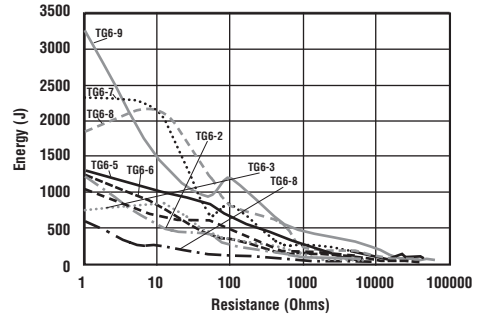

Pulse Energy - TG8

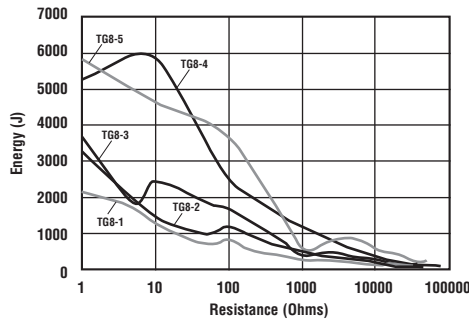

Pulse Energy - TG10

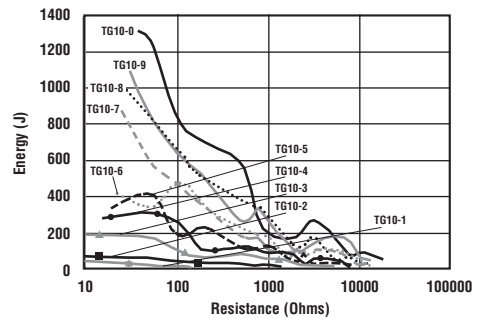

Surface Temperature Rise

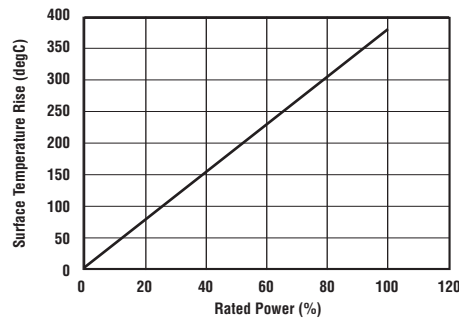

How to Order

TG	5	2	680R	J	B
Common Part	Style Code	Length Code	Resistance Value	Tolerance	Tab Style
TG - Glass Bond Coated Power Resistors	See Table	See Table	0.1ohm (100mΩ) R10 1 ohm (1000mΩ) 1R0 1K (1000Ω) 1K0	J - 5% K - 10%	S - Eyelet B - Faston

Type YP Series

Type YP Series



The YP series resistors are coated with multilayer silicone to give an excellent protection to the resistance wire at temperatures from -55°C to 350°C. The terminals are designed for quick and easy mounting on capacitors and have a mounting pitch of 22.2 and 31.8 mm. These are wirewound ceramic core resistors designed for voltage balancing of series connected aluminium electrolytic capacitors. These resistors are also suitable for capacitor voltage discharge safety applications in high voltage circuits. Ideally suited for industrial grade capacitors.

Characteristics - Electrical

Resistance Values:	2K, 10K, 18K, 27K, 47K. Other values on request and to order
Resistance Tolerance:	±5%
Temperature Coefficient:	±30 ppm/°C (typ.), ±100 ppm/°C (maximum)
Maximum Voltage:	825V dc or ac(rms) for YP10, 570V for YP8
Derating:	Derated linearly to zero at 350°C
Power Rating:	10W @ 70°C for YP10 and 8W @ 70°C for YP8
Stability:	70°C, 1000hr - R/R @ 100% load <±5%
Standard:	Performance as per BS - CECC 40201-002
Marking:	Type, Resistance value, Tolerance

Dimensions

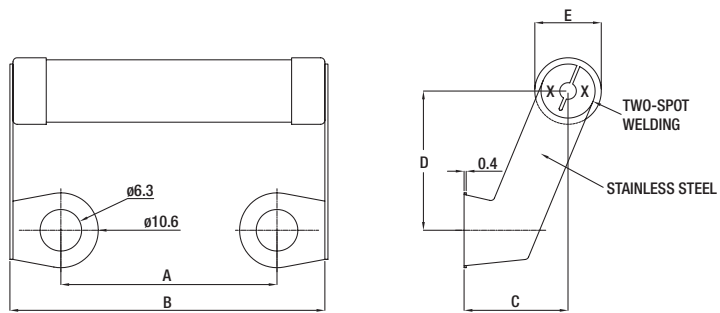

Key Features

- Flameproof Silicone Coating
- Stainless Steel Mounting Terminals for Direct Mounting on Capacitors
- Premium Quality Resistive Wires
- Custom Designs Possible
- Innovative Design

Type	A ±1mm	B max.	C ±1mm	D ±1mm	E ±1mm
YP8	22.2	40	15	21	9.5
YP10	31.8	50	15	21	9.5

How to Order

YP	8	18K	J
Common Part	Power Rating	Resistance Value	Tolerance
YP - Capacitor Discharge Resistor	8 - 8 Watts 10 - 10 Watts	2K (2000 ohms) 2K0 10K (10000 ohms) 10K 18K (18000 ohms) 18K 27K (27000 ohms) 27K 47K (47000 ohms) 47K	J - ±5% K - ±10%

Low Profile Power Resistors

Type MRF Series

Type MRF Series



The MRF range of low profile power resistors offers reliability in the most demanding applications.

With a package height of 13mm this device will fit where space is at a premium and the use of advanced materials enables an operating temperature in excess of 390°C giving very high power and pulse absorption.

Housed in a durable Zinc plated steel casing, this resistor offers environmental protection to IP33 and a dielectric strength of 3kV making it a very practical and versatile choice.

Key Features

- **1300W in a 133cm² footprint**
 - Exceptional power density of 9.8W/cm²
- **Impressive Pulse Capability**
 - Large active element can absorb up to 5.5kJ
- **No Heatsink Required**
 - Dissipates up to 550W in free air
- **Slimline Casing**
 - 13mm casing height for design flexibility
- **Environmental Protection to IP33**
 - Reliable in the harshest conditions

Applications

- Braking
- Balancing
- Capacitor Charging & Discharging
- Crowbar
- Filter
- Power Supplies
- Electrical Machinery
- Inrush Limiting

Characteristics - Electrical

	MRF 600	MRF 900	MRF 1300
Power Dissipation - Air Cooled Heatsink* (W):	600	900	1300
Max. Element Temperature (°C):	390	390	390
Dissipation in Free Air (W):	300	450	550
Power Dissipation - Water Cooled Heatsink** (W):	650	950	1400
Max. Energy - 5s Pulse (kJ):	3	4	5.5
Resistance (Ω):	2-150	2-250	3.3-350
Tolerance (%):	±5	±5	±5
Parasitic Capacitance - 1-100kHz (pF):	90	110	150
Limiting Element Voltage (kV):	1	1	1
Insulation Resistance - 1kV DC (MΩ):	≥1000	≥1000	≥1000
Dielectric Strength - 50Hz 1 min (V _{rms}):	3000	3000	3000
Thermal Time Constant (min):	10	10	10
TCR (ppm/°C):	≤100	≤100	≤100
Cable Length (mm):	200	200	200
Mounting:	Vertical	Vertical	Vertical
Fixing:	M4 x 16 Screw	M4 x 16 Screw	M4 x 16 Screw
Heat Dissipation:	Although the use of proprietary heat sinks with lower thermal resistance is acceptable, up rating is not recommended. The use of proprietary heat sink compound to improve thermal conductivity is essential.		

* Rating of Air Cooled Heatsink: 2°C/W

** Water Cooled Heatsink Temperature: 40°C

Dimensions

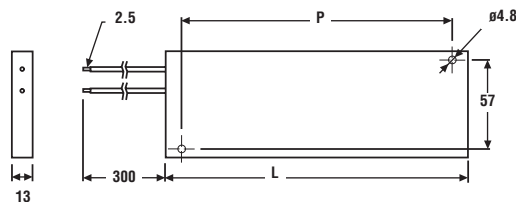

Type	L	P	Rated Power (W)
MRF600	102	81	600
MRF900	145	124	900
MRF1300	195	174	1300

Pulse Energy

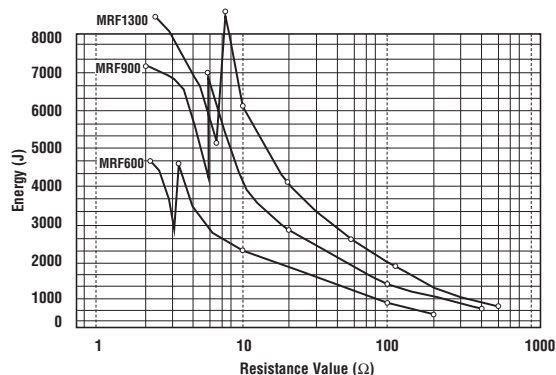

How to Order

MRF	900	100R	J
Common Part	Power Rating with 2°C/W Heatsink	Resistance Value	Tolerance
MRF - Aluminium Housed Power Resistor	600 900 1300	1ohm (1000 mΩ) 1R0 100ohm (100Ω) 100R	J - 5%

High Power Resistors

Type MPC Series

Type MPC Series

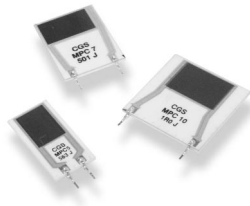

A range of non inductive thick film power resistors complementing the T0220 packaged MPR series (20 Watt heat sink styles), being vertically mounted and suitable to dissipate power from 3 Watts up to 10 Watts. Available in values from 1R0 to 200K ohms they are the idea solution for small snubber circuits, the output side of high speed pulse generators and low inductive resistor requirements in switch mode power supplies.

Key Features

- High Power Density
- Easy to Mount
- Non Inductive
- Stable at 100ppm/°C
- Temperature Range -55°C to +155°C
- High Power up to 10 Watts
- Voltage Proof 5000V dc
- Non Flammable

Characteristics - Electrical

Resistance Values:	1R0 to 200K
Resistance Tolerance:	1%, 5%
Temp. Coefficient of Resistance:	±100ppm/°C
Rated Power @ 70°C:	3 to 10 Watts nominal
Equivalent Parallel Capacitance (100 MHz):	1.0pf
Maximum Operating Voltage:	300V AC
Withstanding Voltage:	5000V
Operating Temperature Range:	-55°C to +155°C
Overload Current:	20 x rated current up to 8 ms (ΔR ± 0.5%)

Mechanical

	Test Condition MILR83401	Specification
Life (Rated Power):	40°C, rated power, 90 min ON 30 min OFF, 1000 hrs.	ΔR± (1.0% + 0.05 ohm)
Life (Moisture Load):	60°C, 90 - 95% RH, rated power 90 min ON 30 min OFF, 1000 hrs.	ΔR± (1.0% + 0.05 ohm)
Temperature Cycling:	Room temp > -55°C 30 min > RT 10 min ± 120°C 30 min > RT 10 min 5 cycles	ΔR± (0.25% + 0.05 ohm)
Flammability:	UL94V-0 rated	
Soldering Heat:	350°C Solderpot, 3 secs.	ΔR± (0.25% + 0.05 ohm)
Insulation Resistance:	DC 100V, 1 min	Over 1000M ohm
Vibration:	10 - 50 Hz, 1 min, 20G, X-Y-Z 1 hr.	ΔR± (0.25% + 0.05 ohm)

Power Derating Curve

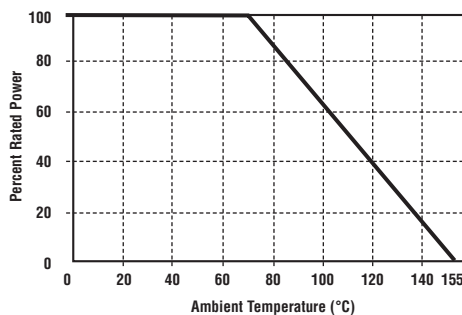

Overload Characteristics

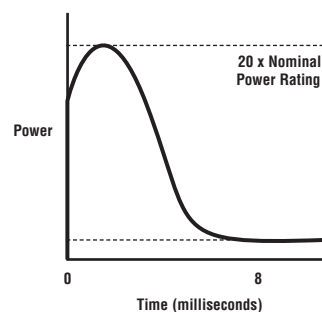

High Power Resistors

Type MPC Series (continued)

Dimensions

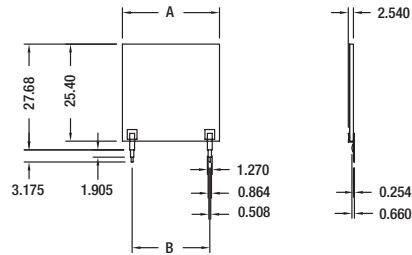

Size	MPC3	MPC5	MPC7	MPC10
A	10.16	12.7	19.05	25.4
B	5.08	5.08	12.70	20.32

Product Marking

Value (Ohms)	1	2	5	10	20	50	100	200	500	1K	2K	5K	10K	20K	50K	100K	200K
Code	1R0	2R0	5R0	100	200	500	101	201	501	102	202	502	103	203	503	104	204

How to Order

MPC	52	1K0	J
Common Part	Power Rating / Size	Resistance Value	Tolerance
MPC - Thick Film Planar Resistor	32 - 3 Watts 52 - 5 Watts 75 - 7 Watts 108 - 10 Watts	0.1 ohm (100 mille ohms) R10 1.0 ohm (1000 mille ohms) 1R0 1K ohms (1000 ohms) 1K0	F ±1% J ±5%

NB: Due to the wide range of available values/tolerances etc. some variants may not be tooled for production. It is possible that a small tooling charge may be levied dependant on order quantity or potential. Please check.

Thick Film Power Resistors

Type BDS100 Series

Type BDS100 Series



With less than 40nH inductance and a 100 Watt power rating in an easy-mounting 38mm x 25mm Isotop case, the BDS100 offers high power density over a wide range of ohmic values (R47 – 1M Ω) and benefits from 10 years experience in the field.

Available in 6 resistor configurations with 2 or 4 easy to connect terminals, the resistors are made from quality materials for optimum reliability and stability with very low partial discharge.

Tyco Electronics Components can test resistors to conform to relevant customer specifications, and will advise on the use of resistors for pulse energy and high voltage applications (HV designs available). Resistors with alternative terminations or flying leads are available, and custom designs are welcome. This product is available via distribution.

Key Features

- **100W in a 9.5cm² footprint**
 - Gives an impressive power density of 10.5W/cm²
- **Virtually inductance-free**
 - Inductance < 40nH
- **Wide resistance range: 0.47 Ω to 1M Ω**
 - Coupled with 1% tolerance gives ultimate design flexibility
- **Multiple terminal configurations and multi-resistor packages**
 - The space saving solution
- **Partial discharge <10pC at 2kV**
 - Guaranteeing quality, reliability and long life

Characteristics - Electrical

Resistance Range:	R47 - 1M Ω	
Resistance Tolerance:	\pm 10%, 5% (Tighter by discussion)	
TCR:	R<1 Ω	\pm 250ppm/ $^{\circ}$ C
	R>1 Ω	\pm 150ppm/ $^{\circ}$ C
Rated Power:	Heatsink: 115 $^{\circ}$ C / 100 $^{\circ}$ C / 60 $^{\circ}$ C	25W / 50W / 100W
Capacitance:	Parallel	15pF
	To Earth	40pF
Series Inductance:	40nH (Maximum)	
Limiting Element Voltage:	(100W or Less)	500Vdc/ac rms
Isolating Voltage:	(Terminal to Heatsink)	2.5kVac rms
Single Shot Voltage:	1.5/50ms	4kV
Insulation Resistance:	(at 500V dc)	>100G Ω
Partial Discharge:	at 2kV	<10pC
Heat Dissipation:	Although the use of proprietary heat sinks with lower thermal resistance is acceptable, up rating is not recommended. The use of proprietary heat sink compound to improve thermal conductivity is essential.	

Environmental

Endurance (Rated Power):	2000cyc. at P _{Rated}	Δ R 0.25% Typ
Humidity Load Life:	56 Days, 40 $^{\circ}$ C, 95% RH	Δ R 0.25% Typ (I.R.>10G Ω)
Temperature Cycling:	-55 $^{\circ}$ C to +125 $^{\circ}$ C, 5cycles	Δ R 0.25% Typ
Operating Storage Temp:	-55 $^{\circ}$ C to +125 $^{\circ}$ C	
Short Term Overload:	3 x P _{Rated} (10s)	Δ R 0.25% Typ
Vibration:	10/500Hz	Δ R 0.25% Typ
Bump:	40g 4000 bumps	Δ R 0.25% Typ

Mechanical

Terminal Size:	M4	
Terminal Torque (max.):	1.3Nm	
Creepage Distance:	10mm	
Clearance:	Terminal to Heatsink	10mm
	Terminal to Terminal	3mm
Heatsink Surface Finish:	R ²	< 6 μ m
Heatsink Flatness:	0.05mm	
Weight:	35g	

Dimensions

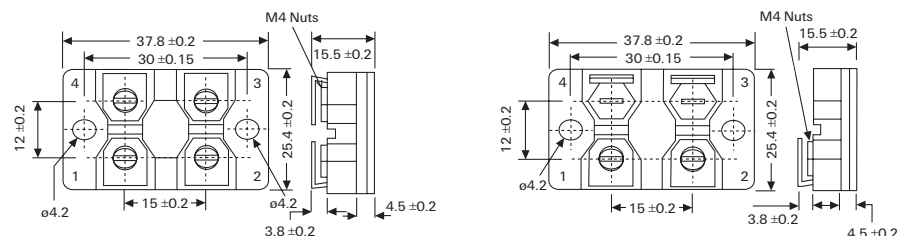

Applications

- Snubbing (Low inductance)
- High Voltage
- Balancing Resistor (Multi-resistor package)
- High Frequency
- Filter (Low inductance)

Terminal Circuit Type

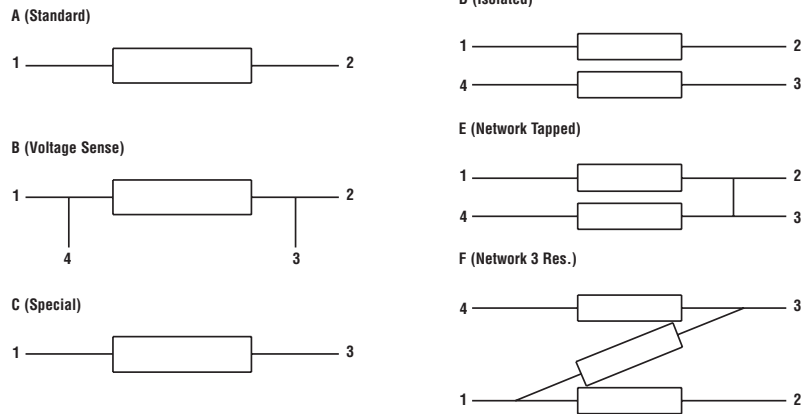

Derating Curve

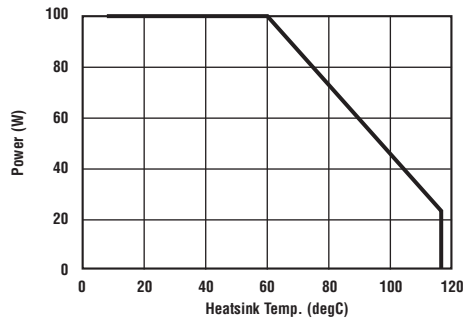

Pulse Energy

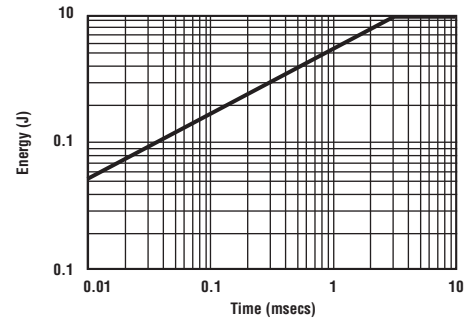

How to Order

BDS 2	A	100	1K0	J
Common Part	Circuit Type	Power Dissipation	Resistance Value	Tolerance
BDS 2 (2 Terminal) BDS 4 (4 Terminal) BDH 2 (2Term. High Voltage) BDH 4 (4 Term. High Voltage)	A: Standard B-F: See above	100 - 100 Watts at 70°C	0.6Ω (600mΩ) R60 1Ω (1000mΩ) 1R0 1KΩ (1000Ω) 1K0 1MΩ (1000000Ω) 1M0	F - 1% J - 5% K - 10%

Thick Film Power Resistors

Type BDS250/400 Series

Type BDS250/400 Series



With less than 40nH inductance and a 250W or 400W power rating (100°C/70°C Heatsink) in a 67mm x 60mm casing, the BDS250/400 offers high power density over a wide range of ohmic values (0R47 – 1M Ω) and benefits from 10 years experience in the field. Available in 5 resistor configurations with 2 or 4 easy to connect terminals, the resistors are made from quality materials for optimum reliability and stability with very low partial discharge.

Tyco Electronics Components can test resistors to conform to relevant customer specifications, and will advise on the use of resistors for pulse energy and high voltage applications (HV designs available).

Resistors with 1% tolerance, alternative terminations or flying leads are available, and custom designs are welcome.

This product is available via distribution.

Key Features

- **400W in a 40.2cm² footprint**
 - Gives an impressive power density of 10W/cm²
- **Virtually inductance-free**
 - Inductance < 40nH
- **Wide resistance range: 0.47 Ω to 1M Ω**
 - Coupled with 1% tolerance gives ultimate design flexibility
- **Multiple terminal configurations and multi-resistor packages**
 - The space saving solution for demanding creep and clearance requirements
- **Partial discharge <10pC at 7.5kV**
 - Guaranteeing quality, reliability and long life

Characteristics - Electrical

Resistance Range:		0R47 - 1M
Resistance Tolerance:		± 10%, 5% (Tighter by discussion)
TCR:	R<1 Ω	± 250ppm/°C
	R>1 Ω	± 150ppm/°C
Rated Power:	Heatsink: 100°C / 70°C	250W / 400W
Capacitance:	Parallel	40pF
	To Earth	160pF
Series Inductance:		40nH (Maximum)
Limiting Element Voltage:		5kV dc/ac rms
Isolating Voltage:	(Terminal to Heatsink)	7kV ac rms
Single Shot Voltage:	1.5/50ms	12kV
Insulation Resistance:	(at 500V dc)	>100G Ω
Partial Discharge:	at 7.5kV	<10pC
Heat Dissipation:	Although the use of proprietary heat sinks with lower thermal resistance is acceptable, up rating is not recommended. The use of proprietary heat sink compound to improve thermal conductivity is essential.	

Environmental

Endurance (Rated Power):	Full Load, 1000h, 25°C	Δ R 0.25% Typ
Humidity Load Life:	56 Days, 40°C, 95% RH	Δ R 0.2% Typ (I.R.>10G Ω)
Temperature Cycling:	-55°C to +125°C, 5cycles	Δ R 0.2% Typ
Operating Storage Temp:	-55°C to +125°C	
Short Term Overload:	750W, 10s	Δ R 0.2% Typ
Vibration:	10/500Hz	Δ R 0.25% Typ
Bump:	40g 4000 bumps	Δ R 0.25% Typ

Mechanical

Terminal Size:		M4
Terminal Torque (max.):		1.3Nm
Creepage Distance:		40mm
Clearance:	Terminal to Heatsink	28mm
	Terminal to Terminal	40mm
Heatsink Surface Finish:	R _a	< 6 μ m
Heatsink Flatness:		0.05mm
Thermal Grease:		Required
Weight:		190g

Dimensions

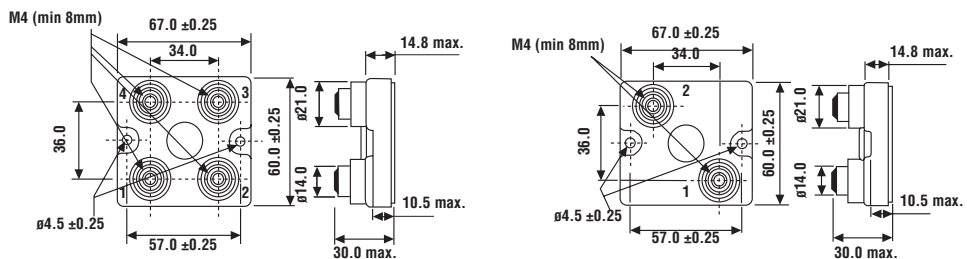

Applications

- Snubbing (Low inductance)
- High Voltage
- Balancing Resistor (Multi-resistor package)
- High Frequency
- Filter (Low inductance)

Thick Film Power Resistors

Type BDS250/400 Series (continued)

Terminal Circuit Type

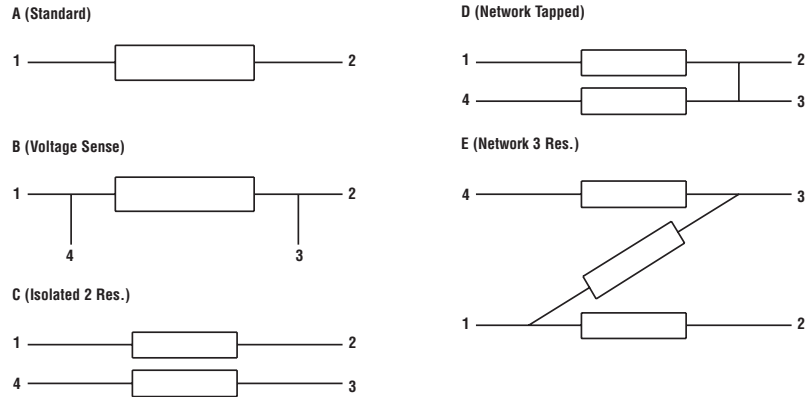

Derating Curve

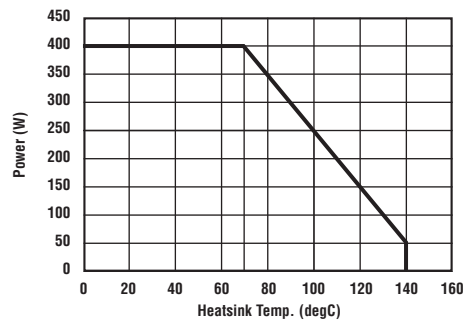

Pulse Energy

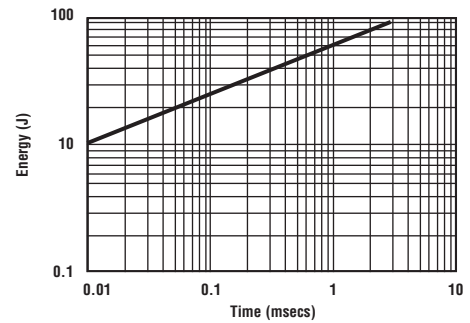

Power Overload

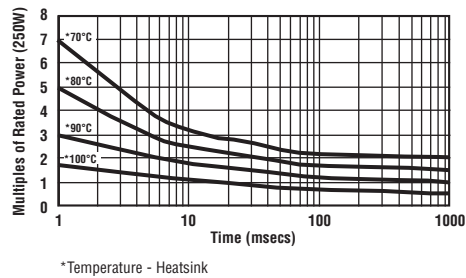

How to Order

BDS 2	A	250/400	1K0	J
Common Part	Circuit Type	Power Dissipation	Resistance Value	Tolerance
BDS 2 (2 Terminal) BDS 4 (4 Terminal)	A: Standard B-E: See above	250 - 250 Watts 400 - 400 Watts	0.47Ω (470mΩ) R47 1Ω (1000mΩ) 1R0 1K (1000Ω) 1K0 1M (100000Ω) 1M0	F - 1% J - 5% K - 10%

Thick Film Power Resistors

Type BDS600 Series

Type BDS600 Series



With a maximum inductance of 80nH and a rated power of 600W (60°C Heatsink) in a 57mm x 60mm casing, the BDS600 offers high power density over a wide range of ohmic values (0R5 – 100K).

This high power density resistor is made from quality materials for optimum reliability and stability with very low partial discharge.

Tyco Electronics Components can test resistors to conform to relevant international, MIL or customer specifications, and will advise on the use of resistors for pulse applications (special pulse duty options available) and high voltage usage (high voltage designs available). The BDS600 offers a limiting element voltage of 5kVac rms, and 10kV isolation voltage (terminal to heatsink). Resistors with 1% tolerance, alternative terminations or flying leads are available, and custom designs are welcome.

This product is available via distribution.

Key Features

- **600W in a 34.2cm² footprint**
 - Gives an impressive power density of 17.5W/cm²
- **Inductance < 80nH**
 - Virtually inductance-free
- **Wide resistance range: 0.5Ω to 100kΩ**
 - Coupled with 1% tolerance gives ultimate design flexibility
- **Multiple terminal configurations**
 - For demanding creep and clearance requirements
- **Partial discharge <5pC at 5kV**
 - Guaranteeing quality, reliability and long life

Characteristics - Electrical

Resistance Range:	0R5 – 100K	
Resistance Tolerance:	± 10%, 5% (Tighter by discussion)	
TCR:	± 150ppm/°C	
Rated Power:	Heatsink: 60°C	600W
Capacitance:	Parallel	40pF
	To Earth	110pF
Series Inductance:	<80nH (Maximum)	
Limiting Element Voltage:	5kV dc/ac rms	
Isolating Voltage:	(Terminal to Heatsink)	10kV ac rms
Single Shot Voltage:	1.5/50ms	12kV
Insulation Resistance:	(at 500V dc)	>1000MΩ
Partial Discharge:	at 7kV	<500pC
	at 5kV	<5pC
Heat Dissipation:	Although the use of proprietary heat sinks with lower thermal resistance is acceptable, up rating is not recommended. The use of proprietary heat sink compound to improve thermal conductivity is essential.	

Environmental

Endurance (Rated Power):	Full Load, 1000h, 25°C	ΔR 0.4% Typ
Humidity Load Life:	56 Days, 40°C, 95% RH	ΔR 0.25% Typ
Temperature Cycling:	-55°C to +125°C, 5cycles	ΔR 0.2% Typ
Storage Temp:	-55°C to +155°C	
Operating Temp:	-55°C to +140°C (200°C on req.)	
Short Term Overload:	1000W, 10s	ΔR 0.4% Typ
Vibration:	2-5000Hz/10g	ΔR 0.25% Typ
Bump:	40g 4000 bumps	ΔR 0.25% Typ

Mechanical

Terminal Size:	M5	
Terminal Torque (max.):	2Nm	
Creepage Distance:	48mm	
Air Gap:	To Heatsink	14mm
Heatsink Surface Finish:	R _a	< 6μm
Heatsink Flatness:	0.05mm	
Thermal Grease:	(0.05°C/Wmm)	Required
Weight:	160g	
Max. Mounting Torque:	1.8Nm	

Dimensions

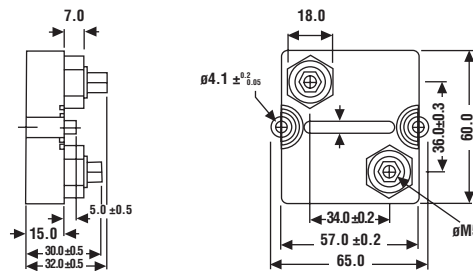

Applications

- Snubbing (Low inductance)
- High Frequency
- Filter (Low inductance)
- Balancing
- High Voltage

Derating Curve

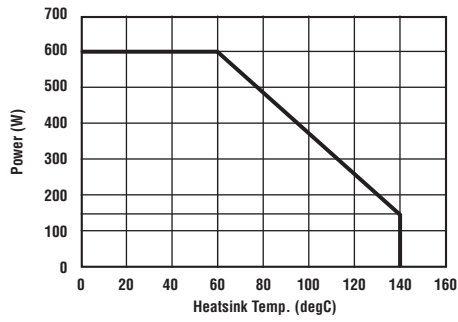

Pulse Energy

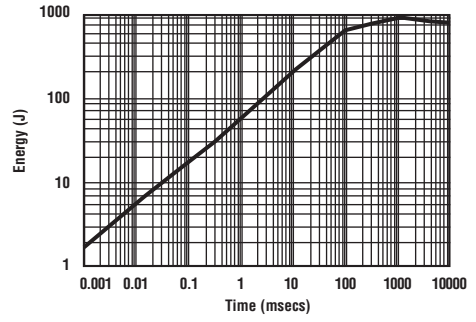

Power Overload

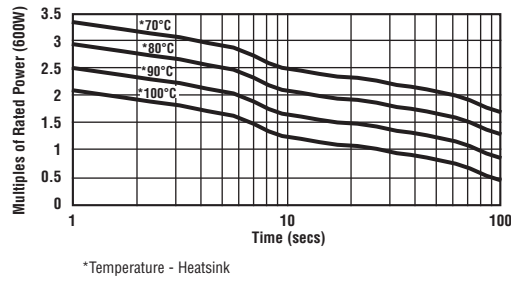

How to Order

BDS 2	A	600	1K0	J
Common Part	Circuit Type	Power Dissipation	Resistance Value	Tolerance
BDS 2 (2 Terminal)	A: Standard	600 - 600 Watts	0.5Ω (500mΩ) R50 1Ω (1000mΩ) 1R0 1K (1000Ω) 1K0	F - 1% J - 5% K - 10%

Power Resistors

Radial Leaded High Power Resistors

Type MPR Series

Type MPR Series

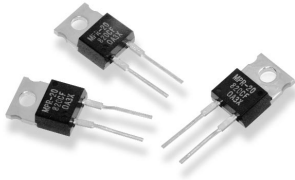

This small size non-inductive, high power resistor is an innovative and significant first for Tyco Electronics Components. Occupying a standard T0220 package it is ideally suited to positions where high power dissipation, small size and tight tolerance are key design requirements.

This series is an ideal solution for the output side of high speed pulse generators, a surge absorption resistor in switch mode power supplies and for monitors, display terminals, scientific workstations and other brown and white goods.

Key Features

- Small Size (T0220 Package)
- Easy to Mount
- Non Inductive
- High Frequency Range up to 300MHz
- Temperature Range -55°C to +155°C
- High Power 20W with Suitable Heatsink
- Voltage Proof 2000V ac
- Non Flammable

Characteristics - Electrical

Resistance Range:	R22 - 51K
Resistance Tolerance:	E12 ± 5% E24 ± 1%
Temperature Coefficient of Resistance:	10R - 51K - 50ppm/°C (1% / 5%), 1R0 - 9R1 - 100ppm/°C (5%), R22 - R91 - 250ppm/°C (5%)
Rated Power (on Suitable Heatsink):	20 watts
Rated Power (W/O Heatsink):	2 watts
Equivalent Parallel Capacitance:	1.0 pF
Maximum Operating Voltage:	500 V dc
Withstand Voltage:	2000 V dc (Between terminals and heatsink)
Operating Temperature Range:	-55°C to +155°C
Rated Ambient Temperature:	-25°C to +40°C

Mechanical

	Test Condition	Specification
Life (Rated Power):	40°C, rated power, 90 min-on, 30 min off, 1000 hours	$\Delta R \pm (1.0\% + 0.05 \text{ ohm})$
Life (Moisture Load):	60°C, 90 - 95% RH, rated power, 90 min ON 30 min OFF, 1000 hours	$\Delta R \pm (1.0\% + 0.05 \text{ ohm})$
Temperature Cycling:	Room temp > -55°C 30 min > RT, 10 min ± 120°C 30 min > RT 10 min, 5 cycles	$\Delta R \pm (0.25\% + 0.05 \text{ ohm})$
Short Time Overload:	Rated voltage x 2.5, 5sec	$\Delta R \pm (0.25\% + 0.05 \text{ ohm})$
Soldering Heat:	350°C solder pot, 3sec	$\Delta R \pm (1.0\% + 0.05 \text{ ohm})$
Insulation Resistance:	DC 100 V, 1 min	Over 1000M ohm
Vibration:	10 - 50 Hz, 1 min, 20G, X-Y-Z 1 hour	$\Delta R \pm (0.5\% + 0.05 \text{ ohm})$

Power Derating Curve

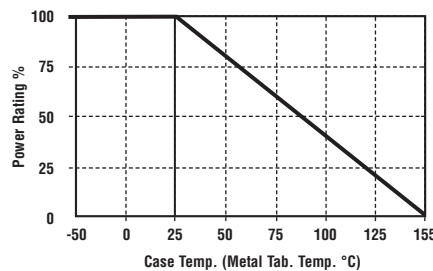

Load Life in High Temperature and Humidity

(70°C 95% DC Rated Power x 0.1) Continuous

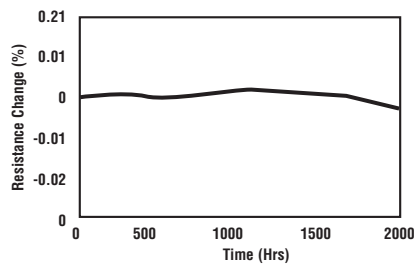

Dimensions

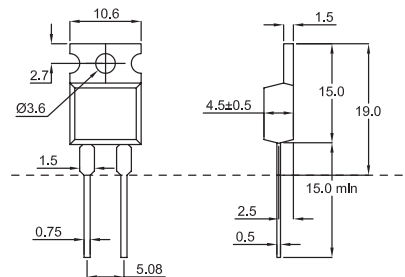

PCB Piercing Plan

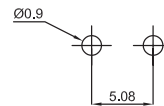

How to Order

MPR	20	C	680R	T
Common Part	Wattage Rating @ 25°C with Heatsink	Temp. Coefficient of Resistance	Resistance Value	Tolerance
MPR - High Power Film Resistor	20 - 20 Watts	C - 50ppm/°C A - 100ppm/°C (5%) H - 250ppm/°C (5%)	0.1 ohm (100 milliohms) R10 1 ohm (1000 milliohms) 1R0 1K ohm (1000 ohms) 1K0	- Bulk Pack T - Ammo Box 1000 pieces

Radial Leaded High Power Resistors

Type MPF Series

Type MPF Series

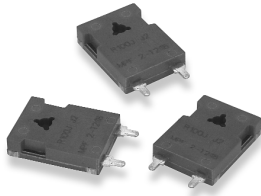

This small non-inductive, high power resistor is another innovative product available from Tyco Electronics Components. Housed in a standard T0218 package it is ideally suited to positions where high power dissipation, small size and tight tolerance are key design requirements. Available with metal alloy or thick film elements, most standard resistance values and tolerances can be achieved. This series is ideally suited for the output stage of high speed pulse generators, a surge absorption resistor in switch mode power supplies and for monitors, display terminals, scientific work-stations and low ohmic current sense positions.

Key Features

- Small Size (T0218 Package)
- Easy to Mount
- Non Inductive
- High Power - 30W
- Temperature Coefficient down to 10ppm/°C
- Tolerances from 0.2%
- Values down to R002
- Non Flammable

Characteristics - Electrical

Resistance Range:	R002 – 50R in E12 Series
Resistance Tolerance:	
From R002	1%, 2%, 5%
From R01	0.5%, 1%, 2%, 5%
From R02	0.25%, 0.5%, 1%, 2%, 5%
From 1R0	0.1%, 0.25%, 0.5%, 1%, 2%, 5%
Thermal Resistance:	2.5K/W
Temperature Coefficient of Resistance:	> R20 ±15ppm/°C (20°C to 60°C) ≤ R20 TCR see table below
Rated Power (Suitable Heatsink):	30 watts (VKK = 25°C)
Rated Power (W/O Heatsink):	2 watts @ 70°C
Stability:	0.1%, 0.2%, 0.5% (depends on stress)
Voltage Proof:	300 V DC
Thermal EMF:	< 1µV/K
Operating Temperature Range:	-40°C to +130°C

Mechanical

Resistor Material:	Metal Foil CuNiMn (DIN 17471)
Substrate:	Anodised Aluminum
Housing:	PPS
Connector Material:	Cu Tinned

Temperature Coefficient

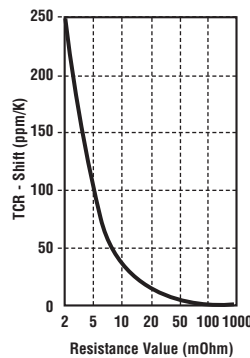
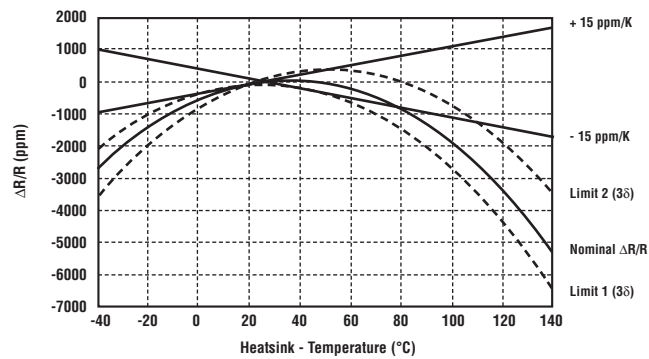

Derating Curve

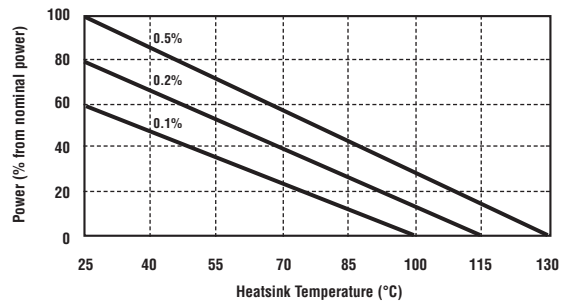

Dimensions

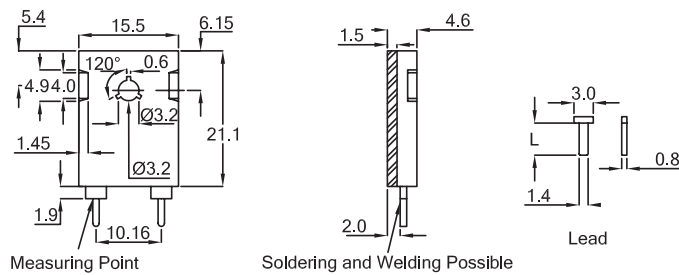

Lead	Length l
A	5.0
B	3.1

Standard Lead for the MPF is style B

How to Order

MPF	1R0	F	B
Common Part	Resistance Value	Resistance Tolerance	Termination
MPF - Planar Resistor	0.2 ohm (200 milli ohms) R20 1.0 ohm (1000 milli ohms) 1R0 50 ohms (50 ohms) 50R	B - 0.1% C - 0.25% D - 0.5% F - 1% G - 2% J - 5%	A - 5.0 x 1.4 B - 3.1 x 1.4

High Power Resistors

Type MPH Series

Type MPH Series

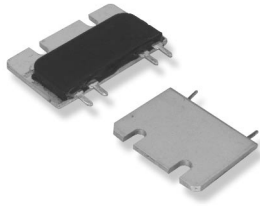

The MPH resistor complements the MPX Series by adding an even higher power rating. With this, user in the area of low ohmic precision can add a 50W device when mounted on a suitable heatsink. By using metal foil on a good heatsink high stability is achieved. Uniform current and power dissipation are the result of tin plated copper terminations with a large surface area. Because of the planar construction the MPH resistor is also non-inductive. The materials used and robust construction guarantee high reliability. The 4 terminal version (Kelvin terminations) can be used where high stability, temperature stability and thermal energy are required.

Key Features

- 50 Watt High Power Dissipation
- Extremely Low Ohmic Values
- Low Inductance
- High Stability
- Kelvin Terminations
- Low TCR

Characteristics - Electrical

	MPH323025 / MPH323818	MPH543825H / MPH344618
Resistance Range:	R01 - 100R	R001 - 100R
Power Rating:	3W (70°C) without heatsink 40W with heatsink	3W (70°C) without heatsink (5W for MPH543825H) 40W with heatsink (50W for MPH543825H)
Thermal Resistance Rthj-c:	2.0 K/W	1.6 K/W
Tolerances: from R001:		1%, 5%
from R005:		0.5%, 1%, 5%
from R010:	0.1%, 0.5%, 1%, 5%	0.1%, 0.5%, 1%, 5%
from R020:	0.1%, 0.5%, 1%, 5%	0.1%, 0.5%, 1%, 5%
Stability:	0.1%, 0.5% (depends on stress) (depends on stress)	0.1%, 0.5%
Temperature Coefficient:	±15ppm/°C (20°C to 60°C) ±25ppm/°C (20°C to 60°C) F Terminal	±15ppm/°C (20°C to 60°C) ±25ppm/°C (20°C to 60°C) F Terminal
	MPH323025 / MPH323818 TCR Shift (see table below)	
Voltage Proof:	500 VDC	500 VDC
Thermal EMF:	1µV/°C	1µV/°C
Maximum Current:	150A / (200A F Terminal)	150A / (200A F Terminal)

Mechanical

Resistor Material:	Metal Foil CuNiMn (to DIN 17471)
Substrate:	Anodized Aluminium
Housing:	Epoxy
Connector Material:	Cu Tinned, 2 and 4 pin
Maximum Torque Back-Plate:	1Nm

Environmental

Operating Temperature Range:	-40°C to 130°C
-------------------------------------	----------------

Temperature Coefficient

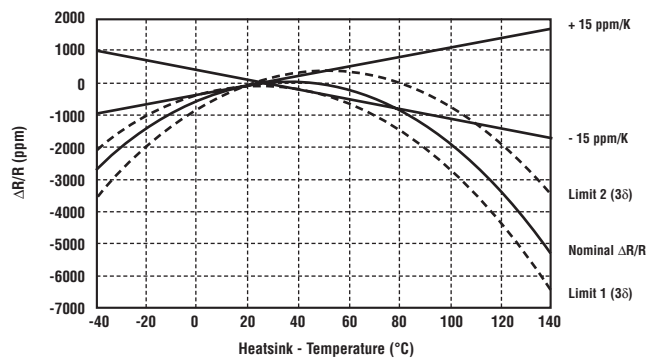

TCR Shift

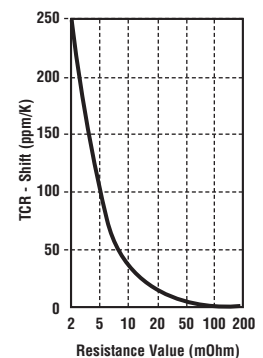

Power Derating Curve

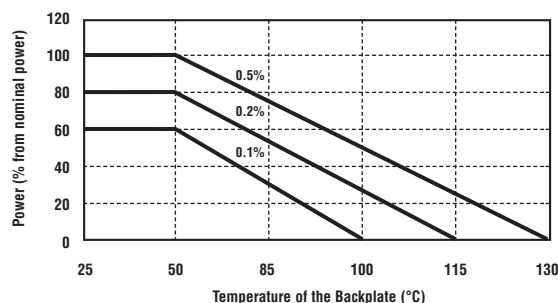

Type MPH Series (continued)

Dimensions -
MPH343825

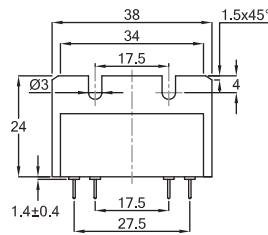

MPH323025

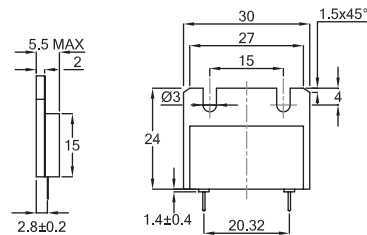

MPH344618

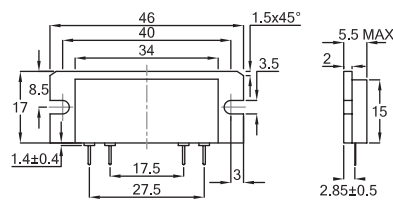

MPH323818

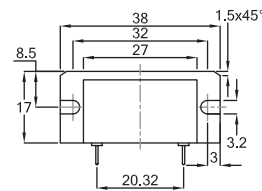

MPH343825---F

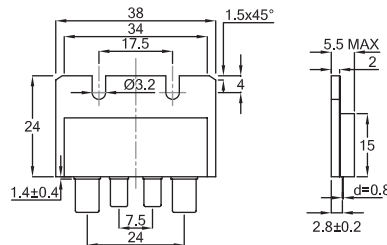

MPH343825H

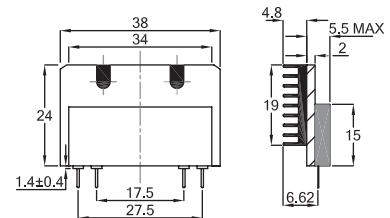

Terminations

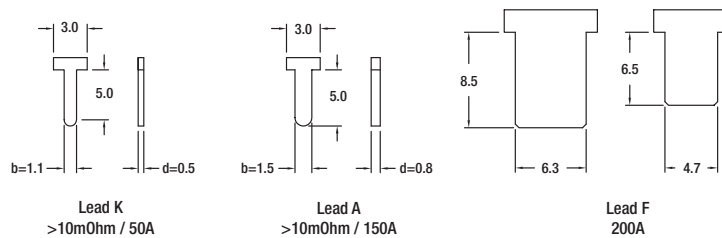

How to Order

MPH	3	43825	R001	B	K
Common Part	Power Rating	Style	Resistance Value	Tolerance	Lead
MPH – Low Ohmic Power Resistor	3 – 3 Watts 5 – 5 Watts (MPH543825H)	23025 23818 43825 42825H 44618	0.001 Ohm (1 milli Ohm) R001 1 Ohm (1.0 Ohm) 1R0 100 Ohms (100 Ohms) 100R	B – 0.1% C – 0.25% D – 0.5% F – 1% G – 2% J – 5%	A F K

Low Profile Power Resistors

Type R5000 Series

Type R5000 Series



The R5000 Resistor Series by Tyco Electronics Components is a high specification flat resistor module with flying leads, designed for braking and snubbing applications where size and weight are at a premium. With a height of 13mm, an overall weight of 150g, and a rated power of 250W, this resistor offers unbeatable performance in terms of power density.

Advanced construction methods and high performance materials give a rugged and resilient device capable of high pulse energy absorption, low inductance, high stability, and a low TCR.

This device can be fused to offer circuit protection and is available in a wide range of resistance values.

Tyco Electronics Components can test resistors to conform to relevant international, MIL or customer specifications, and are happy to advise on the use of resistors for pulse and high voltage applications.

Key Features

- **250W in a 77cm² Footprint**
 - Exceptional power density of 3.25W/cm²
- **13mm Overall Height**
 - Fits where other resistors cannot
- **Special Fuse Option Available**
 - Circuit protection offers improved reliability and safety.
- **Low Inductance for the Fastest Switching Speeds**
 - Less than 1µH for resistances below 20Ω
- **Durability with no Weight Penalty**
 - High quality aluminium construction weighs just 150g

Applications

- Braking
- Snubbing
- Filter
- Power Supplies
- Electrical Machinery

Characteristics - Electrical

Dissipation @ 20°C with Heatsink (Watts):	250
Ohmic Value - Foil (Ohms):	R05 – 20R
Wire Wound (Ohms):	10R – 10K
Tolerance:	± 10%
Limiting Element Voltage (DC/ACrms) Volts:	500V DC or AC Peak
Dielectric Strength (AC peak) Volts:	500V (Can be Up-rated)
Inductance - Foil Element (Henries):	<1 µH
Capacitance (F):	440pF
TCR (ppm/°C):	20 ppm/°C - 150 ppm/°C (to design)
Stability (1000h/250W):	ΔR < 5%
Terminal Strength:	5kg Pull Strength
Temperature Range:	-50°C to 125°C
Humidity (Si-Sealed option):	96% RH @ 40°C - 56days. ΔR <1%
Weight (g):	145
Orientation:	Vertical
Number of Mounting Holes:	2
Cable Length:	130mm ± 10mm
Heat Dissipation:	Although the use of proprietary heat sinks with lower thermal resistance is acceptable, up rating is not recommended. The use of proprietary heat sink compound to improve thermal conductivity is essential.

Dimensions

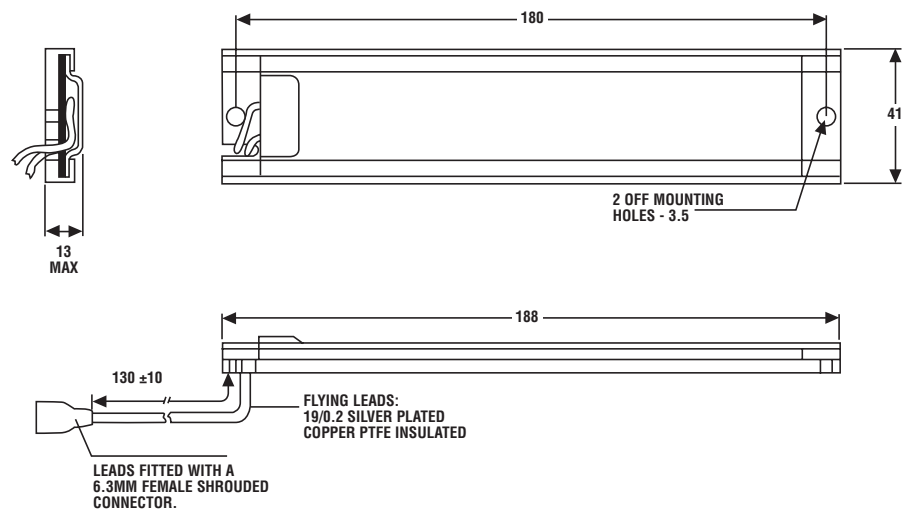

Derating Curve

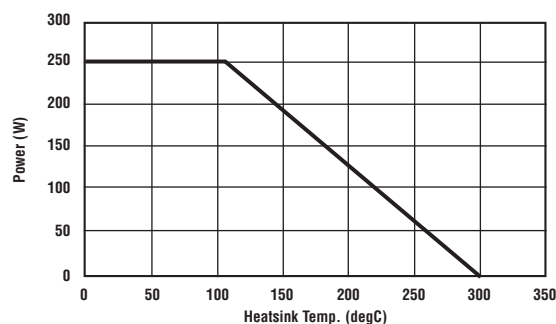

Pulse Energy (Foil Element)



Power Overload

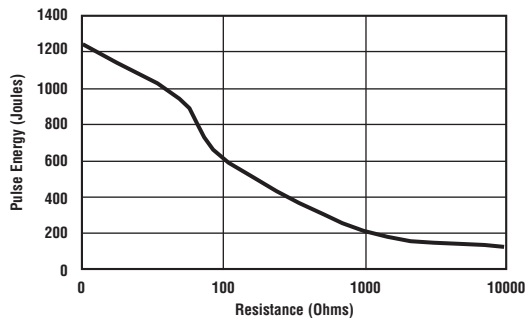

Surface Temperature Rise

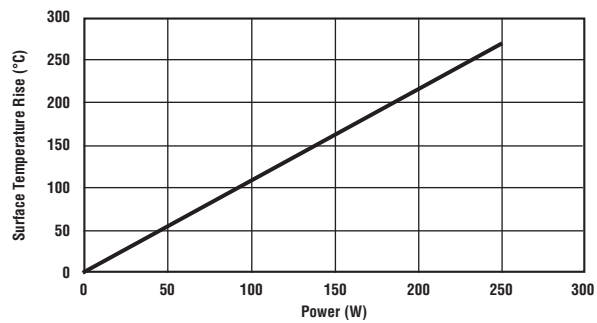

How to Order

The R5000 Series is normally custom designed to meet a specific application. Tyco Electronics Components will allocate a specific part number – Please discuss with our Technical Sales Staff.

Power Resistors

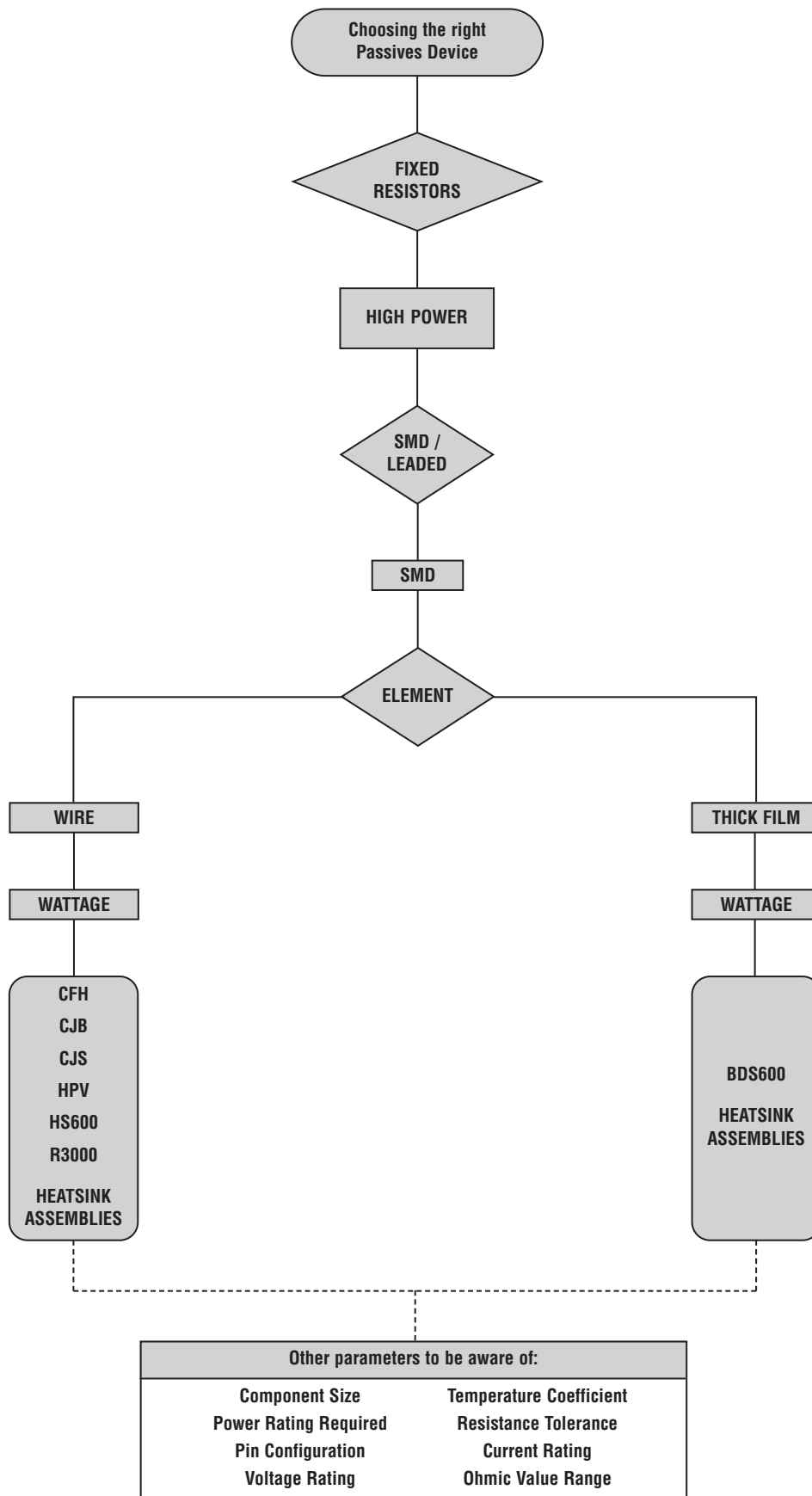

Product Overview

Tyco Electronics has been manufacturing its CGS brand of power resistors for over 50 years.

We offer one of the widest ranges of high power resistor styles and technologies in the world; including thick film, Wirewound and foil. Within these technologies we offer standard ranges of resistors for both low and high ohmic requirements and wattages up to 2200 watts with operating voltages up to 12kV. We offer low inductive versions, a variety of tolerances and temperature coefficients and numerous mounting options.

Our designers specify only the best materials to achieve high quality and long term stability. Our in-house test facility ensures that all products meet our own rigorous test programmes.

We specialise in customisation of the high power resistor range and have a first rate design team based in our R & D facility at Swindon, Wiltshire.

- Market leader in high power technology
- Standard and Custom Designs Available
- Wide range of technologies
- Diverse market applications
- High reliability materials
- In house test facility
- Highly qualified and experienced design team
- Brand name CGS

Max Power Rating Watts	Ohmic Value Range	Tolerance	Working Voltage	Technology	Family	Page
1000	1R0-50K	5-10	2.5kV	Wirewound	HPV	90-91
1000	3R3-750K	1-10	12kV	Wirewound	R3000	92-93
1000	1R0-36K	5	3kV	Wirewound	CJS	94-95
1000	1R0-130R	5-10	2.5kV	Wirewound	CJR	96-97
1000	1R0-130R	5-10	2.5kV	Wirewound	CJB	98-99
600	R50-62K	1-10	2.5kV	Wirewound	HS600	100-101
2200	R50-27K	5	4kV	Wirewound	CFH	102-103
600	R50-100K	5-10	5kV	Thick Film	BDS600	104-105
Various	Various	Various	Various	Various	Heatsink Assemblies	106-107

Aluminium Housed Power Resistors

Type HPV Series

Type HPV Series



Tyco Electronics Components is the leading European supplier of standard and custom designed aluminium housed resistors for general-purpose use, power supplies, power generation and the traction industry. The HPV is a range of extremely stable, high quality wire wound resistors capable of dissipating high power in a limited space with relatively low surface temperatures. The power is rapidly dissipated as heat through the aluminium housing to a specified heat sink. The element assembly is housed within an aluminium extrusion and is insulated by a mineral material, providing better pulse handling capabilities. The HPV resistors have been designed for the power generation industry but are increasingly finding applications in locomotive and other industrial markets where high power, long life and exacting pulse requirements are key design parameters. The resistors are made from quality materials for optimum reliability and stability. Tyco Electronics Components can test resistors to conform to relevant international, MIL or customer specifications. Tyco Electronics Components is happy to advise on the use of resistors for pulse applications and to supply information for high voltage use and low-ohmic value and alternative termination types.

Key Features

- **Up to 1000W power dissipation**
 - Use a single resistor in applications where multiples were used before
- **High pulse energy absorption**
 - Mineral filled to handle up to 7000joules
- **6.5kV voltage isolation**
 - Meets tough specifications with a factor of safety
- **Proven reliability**
 - 1000Watts with HS reliability
- **Custom designs:**
 - Windings, terminations
 - We have a solution for your application

Characteristics - Electrical

	HPV500	HPV1000
Dissipation @ 25°C with Heatsink (Watts) (Maximum continuous):	500	1000
Without Heatsink:	100	200
Ohmic Value Min (Ohms):	0R5	1R0
Max:	33K	50K
Limiting Element Voltage (Volts) (DC/AC rms) (For continuous operation):	2.5kV	2.5kV
Dielectric Strength (Volts) (AC rms):	6.5kV	6.5kV
Pulsed Voltage (Volts) (1.2/50ms):	12kV	12kV
Insulation Resistance @ 500V (Ohms>10GΩ):	>10GΩ	
Stability (% resistance change, 1000 hours)(%):	≤ 2%	≤ 2%
Temperature Coefficient (ppm/°C):	<±100ppm/°C	<±100ppm/°C
Environmental Category:	-55/200/56	-55/200/56
Creep (mm):	43Min	43Min
Clearance (mm):	20Min	20Min
Long Term Stability:	For improvements in long-term stability, resistors must be derated as follows; for 50% of stated ΔR maximum dissipation must not exceed 70% of rating; for 25% of stated ΔR maximum, dissipation must not exceed 50% of rating.	
Heat Dissipation:	Although the use of proprietary heat sinks with lower thermal resistance is acceptable, up rating is not recommended. The use of proprietary heat sink compound to improve thermal conductivity is essential.	

Dimensions HPV500

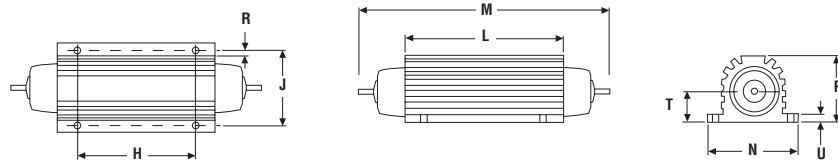

HPV1000

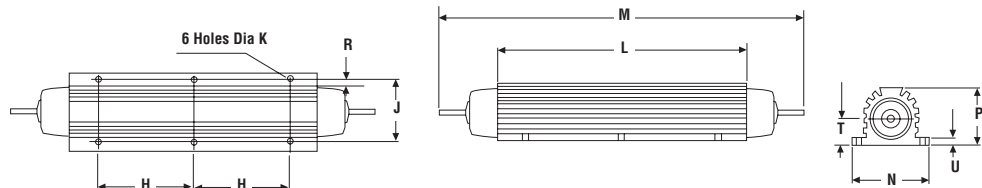

Type	H±0.3	J±0.4	K±0.3	L Max	M Max	N Max	P Max	R Min	T±0.3	U Min
HPV500	76.2	63.5	5.8	136.0	225.0	78.0	58.0	4.0	27.0	5.8
HPV1000	97.0	63.5	5.8	255.0	365.0	78.0	58.0	4.0	27.0	5.8

Note: K refers to mounting hole diameter

Applications

- High Voltage
- Filter
- Crowbar
- Braking
- Balancing
- Capacitor Charging & Discharging
- Electrical Machinery

Derating Curve

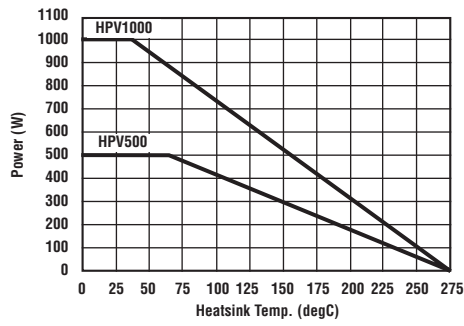

Pulse Energy

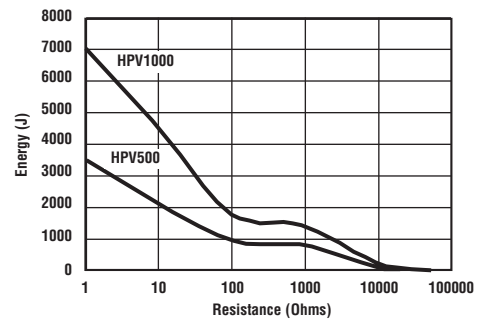

Surface Temperature Rise

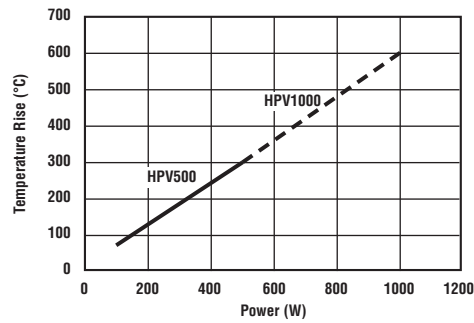

High Power Resistors

How to Order

HPV	500	680R	J
Common Part	Power Rating	Resistance Value	Tolerance
HPV - Aluminium Housed Power Resistor	500 - 500 Watts 1000 - 1000 Watts	0.1ohm (100mΩ) R10 1 ohm (1000mΩ) 1R0 1K (1000Ω) 1K0	F - 1% G - 2% E - 3% J - 5% K - 10%

Type R3000 Series

Type R3000 Series



Tyco Electronics Components is the leading European supplier of standard and custom mineral insulated resistors for high voltage snubbing applications. The R3000 range is designed to meet the demands of high voltage switching applications and offers extremely stable, high quality wire wound resistors capable of dissipating high power in a limited space with relatively low surface temperature. The power is rapidly dissipated as heat through the aluminium housing to a specified heatsink. The resistors are made from quality materials for optimum reliability and stability. Tyco Electronics Components can test resistors to conform to relevant customer specifications. Tyco Electronics Components is happy to advise on the use of resistors for pulse applications and to supply information for high voltage use and low-ohmic value, alternative mountings and termination type.

Key Features

- **1000W in a 150cm² Footprint**
 - Exceptional power density of 6.7 W/cm²
- **Partial Discharge < 5pC at 3.7kV RMS**
 - Giving quality, reliability and long life
- **12kV Voltage Isolation**
 - Meeting tough specifications with a factor of safety
- **Special Pulse Options Available**
 - Maximised wire wound element technology for high pulse energy absorption
- **Low Inductance and Capacitance**
 - For the fastest switching speeds
- **Unparalleled Insulation Resistance**
 - 50GΩ offers high performance in every application

Characteristics - Electrical

Dissipation on 75°C Heatsink (Watts):	1000 (500 per element)
Without Heatsink (T _{ambient} : 23°C):	200 (100 per element)
Power Overload (ΔR < 0.25%):	4 x P _{rated} for 20s
Ohmic value - Per Element (Ohms):	3R3 - 750K
Tolerance:	5% Standard (1%, 2%, 3%, 10% Available)
Limiting Element Voltage (DC/ACrms) Volts:	3.2kV (subject to resistor value)
Insulation Resistance @500V dc (Ohms)	>50 x 10 ⁹
Dielectric Strength - Terminal to Terminal (AC peak):	12 kV
Terminal to Case:	12 kV
Mounting Orientation:	Vertical
Inductance (H):	<3.8μH (at 44Ω)
Capacitance (F):	130pF
Partial Discharge (C):	<5pC at 3.7KVRMS
Time Constant (μs):	<0.1
Creep Path (mm):	50
Weight (g):	1646
Heat Dissipation:	Although the use of proprietary heat sinks with lower thermal resistance is acceptable, up rating is not recommended. The use of proprietary heat sink compound to improve thermal conductivity is essential.

Dimensions

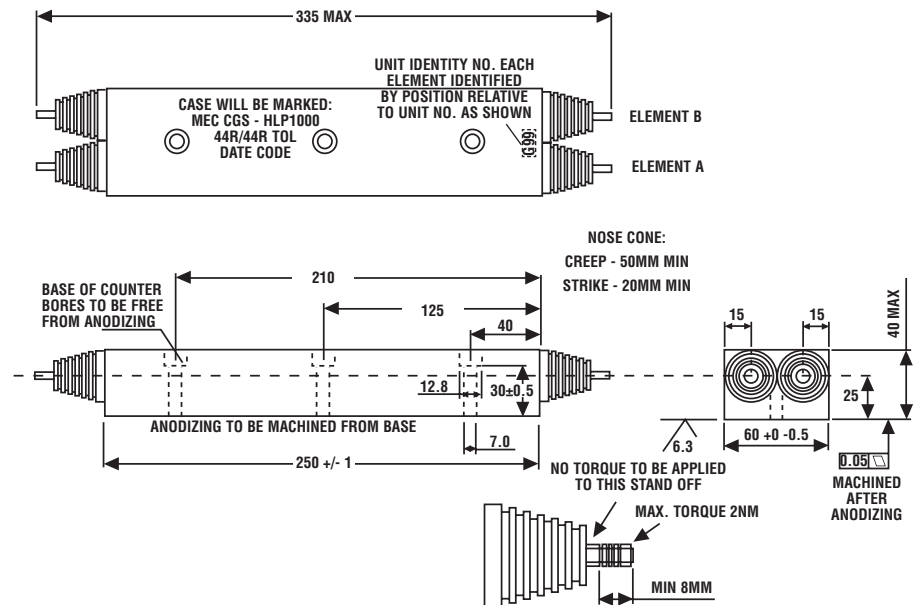

Applications

- Braking
- Snubbing
- Filter
- Power Supplies
- Electrical Machinery

Derating Curve

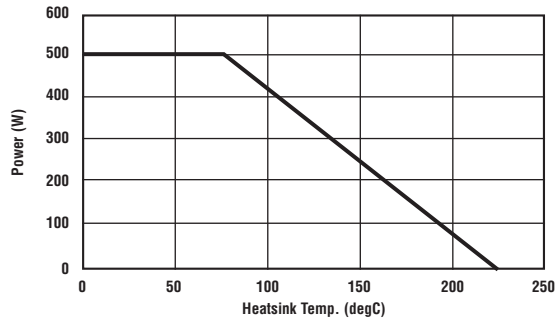

Pulse Energy



High Power Resistors

Surface Temperature Rise

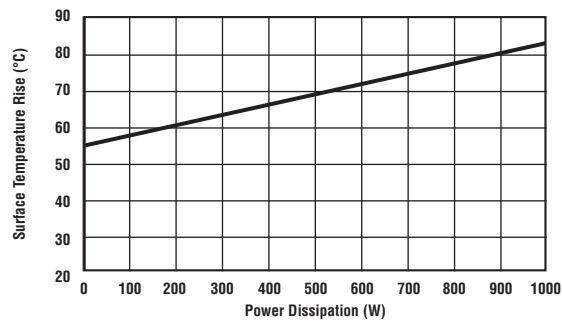

How to Order

R3000	680R	J
Common Part	Resistance Value	Tolerance
R3000 - Aluminium Housed Power Resistor	0.1ohm (100mΩ) R10 1 ohm (1000mΩ) 1R0 1K (1000Ω) 1K0	F - 1% G - 2% E - 3% J - 5% K - 10%

Aluminium Housed Power Resistor

Type CJS Series

Type CJS Series



Tyco Electronics Components is the leading European supplier of standard and custom designed mineral insulated resistors for general-purpose, drives and controls.

The CJS mineral filled power resistor in durable aluminium housing offers high performance as a braking resistor for large drives.

The high overload rating enables the absorption of high-energy pulses with a compact device.

A variety of terminations are available to meet customer requirements including Faston, terminals, butt splices etc.

Key Features

- **High Power Dissipation**
 - Up to 1000W with a heatsink, and 525W without
- **Unsurpassed Pulse Capability**
 - Large active element can absorb 18kJ
- **High Voltage Withstand**
 - Reliability at 3kV
- **High Stability**
 - Specify the CJS with complete confidence
- **10 Times Overload Rating**
 - A compact and cost effective solution

Applications

- Braking
- Capacitor Charging & Discharging
- Crowbar
- Filter
- Power Supplies
- Electrical Machinery

Characteristics - Electrical

	CJS275	CJS300	CJS550	CJS600	CJS700	CJS1000
Dissipation at 25°C - With Heatsink (W):	275W	300W	550W	600W	700W	1000W
Without Heatsink:	175W	225W	325W	450W	525W	525W
Ohmic Value - Min (Ω):	1R0	1R0	2R0	2R0	2R0	2R0
Max:	7k5	13k	26k	32k	32k	36k
Maximum Working Voltage - DC/ACrms (Volts):	3kV	3kV	3kV	3kV	3kV	3kV
Dielectric Strength - AC peak (Volts):	5kV	5kV	5kV	5kV	5kV	3.5kV
Capacitance to Ground:	35pF	60pF	115pF	122pF	165pF	165pF
Insulation Resistance (Ω):	> 100M at 500V					
Stability - % Resistance Change, 1000 hours (%):	<5%	<5%	<5%	<5%	<5%	<5%
Standard Heatsink:	Liquid Cooled (75°C max) 0.24°C/W					
Weight (g):	990	1450	2125	2590	3675	3675
Cable Length:	1m					
Mounting:	Vertical					
Heat Dissipation:	Although the use of proprietary heat sinks with lower thermal resistance is acceptable, up rating is not recommended. The use of proprietary heat sink compound to improve thermal conductivity is essential.					

Dimensions - CJS300 / CJS275

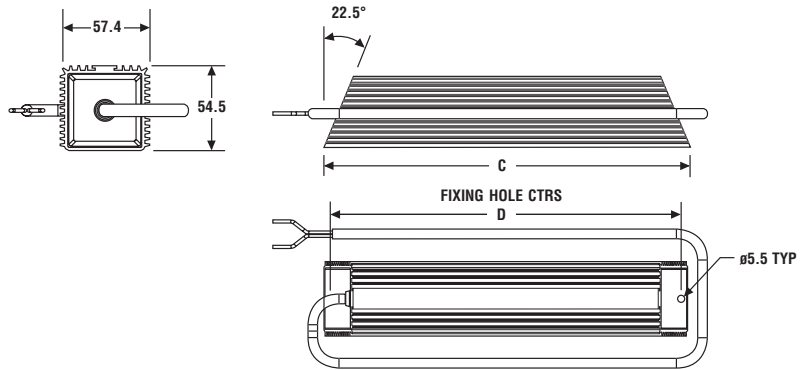

Dimensions - CJS1000 / CJS700 / CJS600 / CJS550

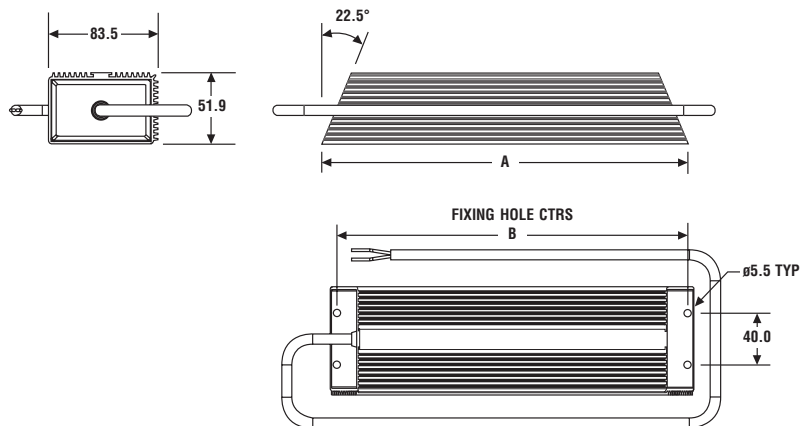

Type	A	B	C	D
CJS275	-	-	200	190
CJS300	-	-	280	270
CJS550	280	270	-	-
CJS600	340	330	-	-
CJS700	400	390	-	-
CJS1000	400	390	-	-

Derating Curve

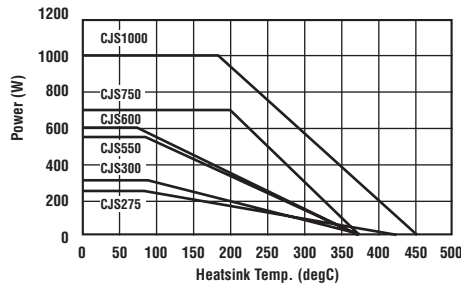

Pulse Energy

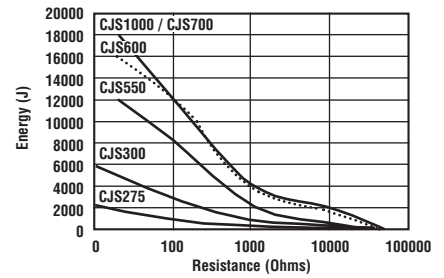

Power Overload

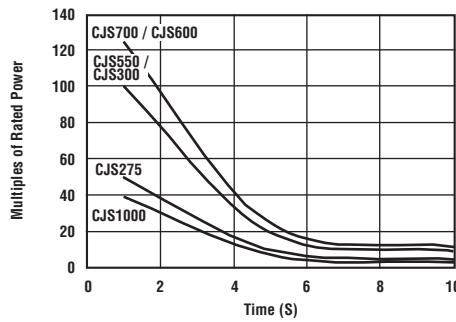

Surface Temperature Rise - In Free Air

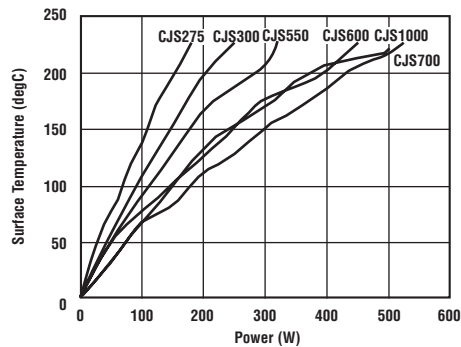

Surface Temperature Rise - Heatsink

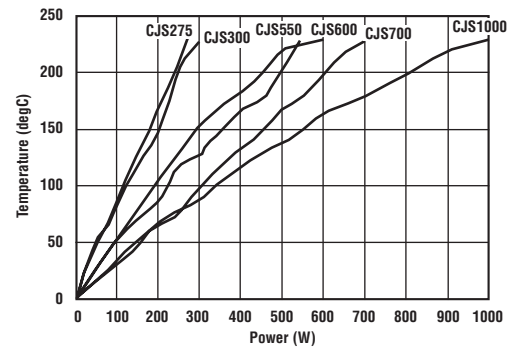

How to Order

CJS	275	680R	J
Common Part	Power Rating at 25°C wih Heat Sink	Resistance Value	Tolerance
CJS - Aluminium Housed Power Resistor	275 300 550 600 700 1000	0.1ohm (100mΩ) R10 1 ohm (1000mΩ) 1R0 1K (1000Ω) 1K0	J - 5% K - 10%

Low Profile Power Resistor

Type CJR Series

Type CJR Series



The CJR range of power resistors are aluminium housed and wire wound, designed to withstand high adiabatic pulses in a compact package. These devices offer a high power dissipation capacity with the appropriate heat sink and superior environmental protection (IP64). The product is silicone free for specific use on assembly cells within the automotive assembly industry.

Key Features

- **High Power Dissipation**
 - 1000W in a 15mm package
- **Low Profile**
 - Fits where other resistors cannot
- **IP64 Environmental Protection**
 - World-wide use in any industry
- **High Pulse Capability**
 - Fits today's dynamic breaking requirements
- **Overload 20 Times Rated Power**
 - A compact and cost effective solution
- **Silicone-Free**
 - Designed for automotive assembly lines

Applications

- Braking
- Capacitor Charging & Discharging
- Crowbar
- Filter
- Power Supplies
- Electrical Machinery
- Robotics

Characteristics - Electrical

	CJR250	CJR500	CJR750	CJR1000
Power Dissipation Free Air (W):	100	150	200	250
Power Dissipation Mounted on Heatsink (W):	250	500	750	1000
Ohmic Value Min (Ohms):	1Ω	1Ω	2Ω	2Ω
Max:	30Ω	60Ω	100Ω	130Ω
Resistance Tolerance (%):	5%, 10%	5%, 10%	5%, 10%	5%, 10%
Maximum Case Temperature (°C):	270	270	270	270
Stability at Rated Power - 1000hr's (%):	±6.5%	±6.5%	±6.5%	±6.5%
Insulation Resistance @500V (GΩ):	>1.0	>1.0	>1.0	>1.0
Isolation Voltage - 1min AC rms (kV):	2.5kV	2.5kV	2.5kV	2.5kV
Series Inductance @ 10kHz (mH):	<2.5	<4.5	<5.0	<13.0
Capacitance terminal to case @ 10kHz (pF)	<200	<300	<400	<500
Operating Temperature Range (°C):	-40 to 75	-40 to 75	-40 to 75	-40 to 75
Overload Ratings:	20 x Rated power for 1 second every minute 4 x Rated power for 5 seconds every minute			
Terminations:	PTFE / ETFE coated flying leads (to BS6360)			
Storage Temperature Range (°C):	-40 to 270			
IP Rating:	IP64			
Case Finish:	Natural Anodised			
Heat Dissipation:	Although the use of proprietary heat sinks with lower thermal resistance is acceptable, up rating is not recommended. The use of proprietary heat sink compound to improve thermal conductivity is essential.			

Dimensions

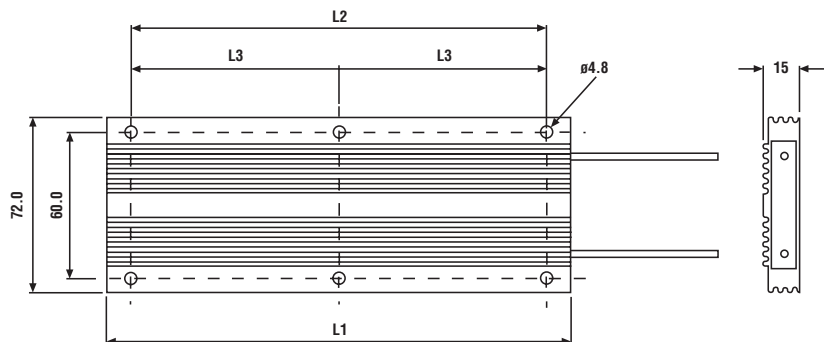

Type	L1	L2	L3
CJR250	110	90	-
CJR500	190	170	85
CJR750	270	250	125
CJR1000	350	330	165

Low Profile Power Resistor

Type CJR Series (continued)

Derating Curve

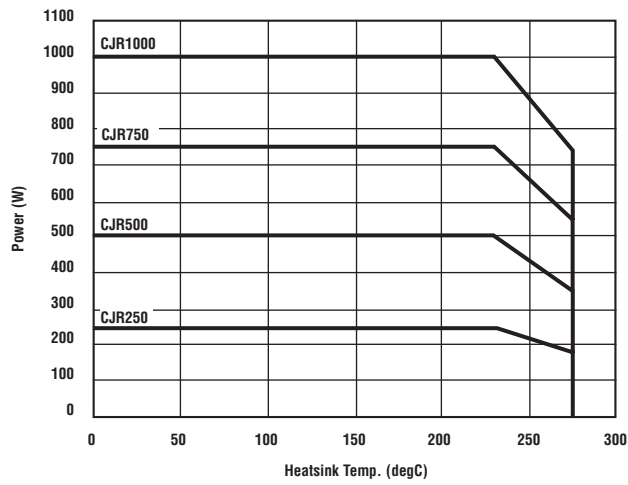

Pulse Energy

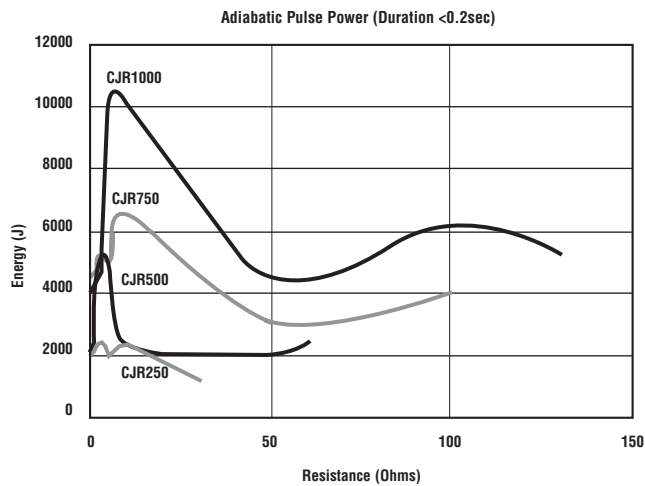

High Power Resistors

How to Order

CJR	500	1R0	J
Common Part	Power Rating	Resistance Value	Tolerance
CJR - Low Profile Power Resistor	250 500 750 1000	1ohm (1Ω) 1R0	J - 5% K - 10%

Low Profile Power Resistor

Type CJB Series

Type CJB Series



The CJB range of power resistors is aluminium housed and wirewound, designed to withstand high adiabatic pulses in a compact package. These devices offer a high power dissipation capacity with the appropriate heatsink and superior environmental protection (IP64).

Tyco Electronics Components can test resistors to conform to relevant international MIL and customer specifications and will advise on the use of resistors for pulse applications.

Key Features

- **High Power Dissipation**
 - 1000W for under 1kg
- **Low Profile**
 - Fits where other resistors don't
- **IP64 Environmental Protection**
 - Worldwide use in any industry
- **High Pulse Capability**
 - Fits today's dynamic braking requirements
- **Overload 20 times rated power**
 - Providing a size and cost effective solution

Applications

- Braking
- Capacitor Charging & Discharging
- Crowbar
- Filter
- Power Supplies
- Electrical Machinery

Characteristics - Electrical

	CJB250	CJB500	CJB750	CJB1000
Power Rating Free Air (W):	100	150	200	250
Power Rating Mounted on Heatsink (W):	250	500	750	1000
Maximum Case Temperature (°C):	270			
Stability at Rated Power (1000hrs):	±6.5%			
Resistance Range (Ω):	1 – 30	1 – 60	1 – 100	1 – 130
Tolerances Available:	± 5%, ±10%			
Insulation Resistance @ 500V (GΩ):	>1.0			
Isolation Voltage (1 minute ACrms):	2.5kV			
Series Inductance @ 10kHz (mH):	<2.5	<4.5	<5.0	<13.0
Capacitance Terminal to Case @ 10kHz (pF):	<200	<300	<400	<500
Operating Temperature (°C):	-40 to +70			
Overload Rating:	20x Rated Power For 1 Second Every Minute			
Overload Rating:	4x Rated Power For 5 Seconds Every Minute			
Terminations:	Silicone Coated Flying Leads			
Storage Temperature (°C):	-40 to +270			
IP Rating:	64			
Case Finish:	Natural Anodised			
Heat Dissipation:	Although the use of proprietary heat sinks with lower thermal resistance is acceptable, up rating is not recommended. The use of proprietary heat sink compound to improve thermal conductivity is essential.			

Dimensions

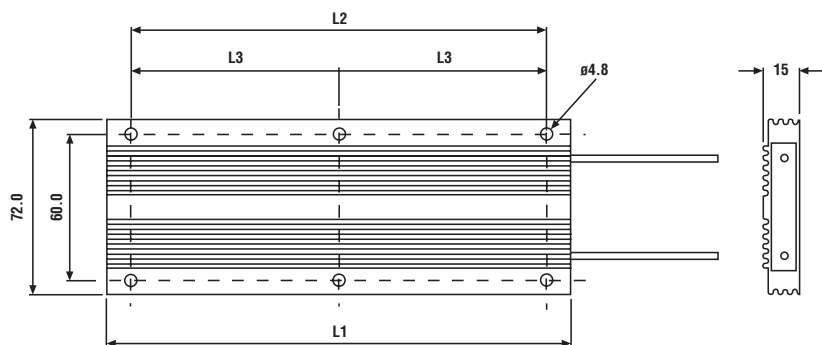

Type	L1	L2	L3
CJB250	110	90	-
CJB500	190	170	85
CJB750	270	250	125
CJB1000	350	330	165

Low Profile Power Resistor

Type CJB Series (continued)

Derating Curves

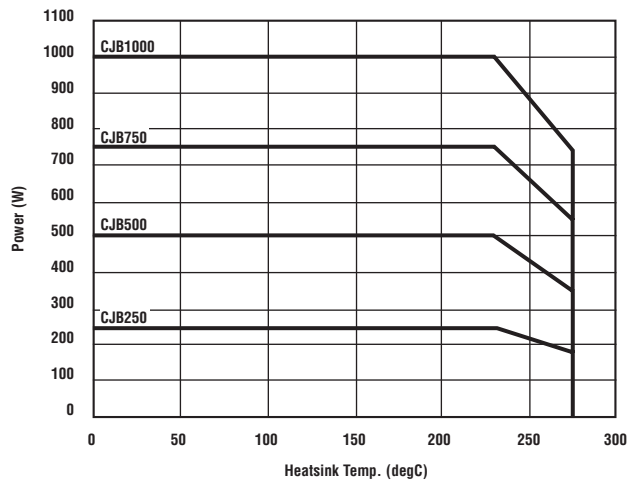

Pulse Energy

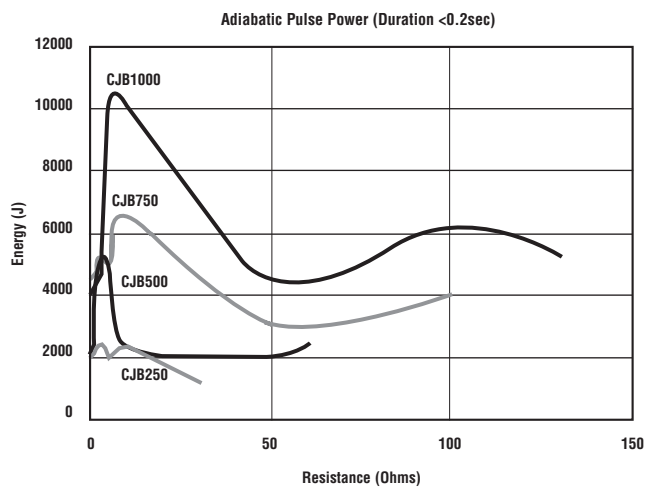

High Power Resistors

How to Order

CJB	250	1R0	J
Common Part	Power Rating	Resistance Value	Tolerance
CJB - Low Profile Power Resistor	250 500 750 1000	1ohm (1000 mille ohms) 1R0	J - 5% K - 10%

Direct Water Cooled Power Resistors

Type HS600 Series

Type HS600 Series



Tyco Electronics Components is the leading European supplier of standard and custom designed aluminium housed resistors for general-purpose use, power supplies, power generation and the traction industry. The HS600 resistor is based on the proven HSC300 power resistor, offering double the power capacity when cooled by liquid flowing through a coil encased in the cast aluminium body.

Water-cooling enables high power dissipation in a very small envelope as no heatsink is required. The use of proven HS technology ensures reliability and stability.

The resistors are made from quality materials for optimum reliability and stability. Tyco Electronics Components can test resistors to conform to relevant international, MIL or customer specifications.

Tyco Electronics Components is happy to advise on the use of resistors for pulse applications and to supply information for high voltage use and low-ohmic value, alternative mountings and termination type.

Key Features

- **600W Power Dissipation**
 - Direct water cooling eliminates the cost, weight and size penalty of heatsinking
- **Established Product with Proven Reliability**
 - Leading the field with over 40 years of manufacture
- **No Need for Deionised Water**
 - Mixing water and high voltage safely
- **10000MΩ Insulation Resistance**
 - You won't need higher
- **Horizontal or Vertical Mounting**
 - For flexible designs at high power density

Characteristics - Electrical

Dissipation at 25°C (Watts):	600W
Ohmic Value - Min (Ohms):	0R6
Max:	62K
Maximum Working Voltage - DC/ACrms (Volts):	2.5 KV
Dielectric Strength - AC peak (Volts):	3.5KV
Mounting Style:	Vertically or Horizontally
Number of Mounting Holes:	3
Weight:	1.25 kg
Creep Path:	20mm min
Coolant Liquid Flow:	>0.8l/m
Pressure Drop:	>0.4 atm
Coolant Temperature:	<56°C
Long-Term Stability:	For improvements in long-term stability, resistors must be derated as follows; for 50% of stated ΔR maximum dissipation must not exceed 70% of rating; for 25% of stated ΔR maximum, dissipation must not exceed 50% of rating.
Insulation Resistance:	Dry: 10,000MΩ minimum. After moisture test: 1000MΩ minimum.
Specification:	Temperature coefficient below 100R, 50ppm/°C Temperature coefficient above 100R, 30ppm/°C Tolerance, 5% standard: 10%, 3%, 2%, & 1% available.

Dimensions - Stainless Steel Tabs

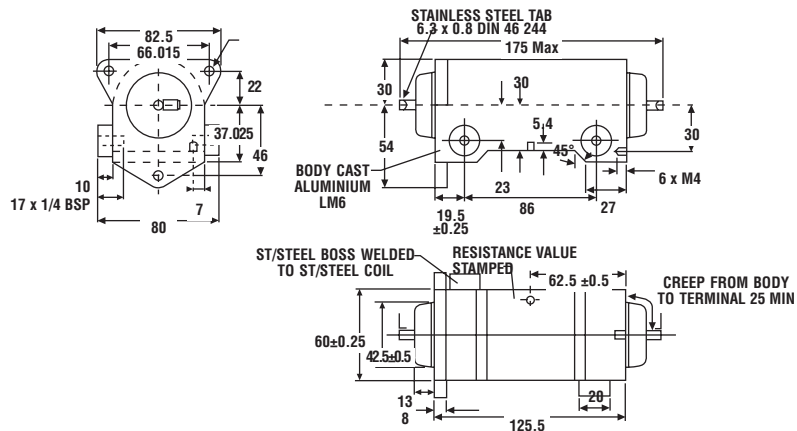

Stainless Steel M6 Threaded Stud

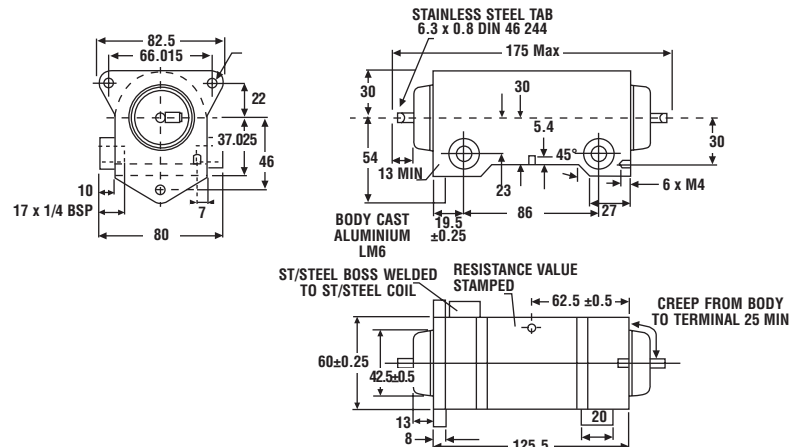

Applications

- Braking
- Crowbar
- Electrical Machinery
- Balancing
- Filter
- Inrush Limiting
- Capacitor Charging & Discharging
- Power Supplies

Derating Curve*

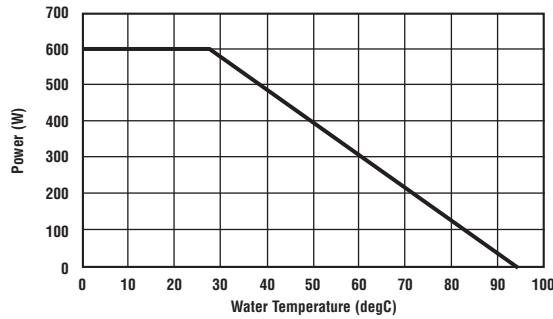

* Water Inlet Temperature 25°C

Pulse Energy

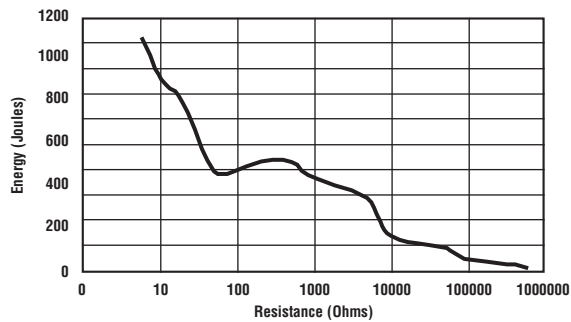

High Power Resistors

Surface Temperature Rise*

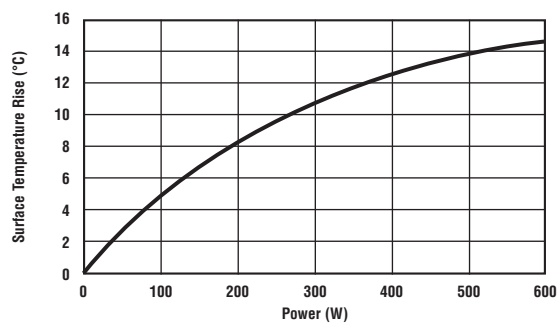

* Water Inlet Temperature 25°C

How to Order

The HS600 Series is normally custom designed to meet a specific application. Tyco Electronics Components will allocate a specific part number – Please discuss with our Technical Sales Staff.

Aluminium Housed Power Resistors

Type CFH Series

Type CFH Series

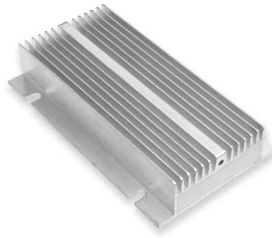

The CFH high quality range of aluminium housed power resistors offers environmental protection to IP55, 6kV dielectric strength, 1.8kW power dissipation, and the ability to absorb electrical pulses of up to 24kJ.

The use of advanced materials in the construction of this device enables operating temperatures of up to 450°C giving very high power density.

Key Features

- **2200W in a 72cm² footprint**
 - Unparalleled power density of 31W/cm²
- **Impressive Pulse Capability**
 - Large active element can absorb up to 24kJ
- **No Heatsink Required**
 - Dissipates up to 950W in free air
- **Slimline Casing**
 - 30mm casing height for design flexibility
- **Environmental Protection to IP55**
 - Reliable in the harshest conditions

Applications

- Braking
- Balancing
- Capacitor Charging & Discharging
- Crowbar
- Filter
- Power Supplies
- Electrical Machinery
- Inrush Limiting

Characteristics - Electrical

	CFH350	CFH500	CFH750	CFH1100
Dissipation @ 25°C with Heatsink (Watts):	650	850	1300	1800
Without Heatsink:	350	500	750	1100
With Water Cooled Heatsink (40°C):	750	1000	1500	2200
Overload Rating (5s):	4000	5600	8000	12000
Ohmic Value Min (Ohms):	0R5	0R5	0R5	0R5
Max:	10K	18K	27K	27K
Tolerance:	±5% Standard			
Maximum Working Voltage (DC/ACrms) Volts:	1500	2500	3500	4000
Insulation Resistance (Volts):	>=10000 MΩ			
Dielectric Strength (AC peak) Volts:	4500 standard and 6000 special			
Inductance (Henries):	5-50 μH at 1000 Hz	7-70 μH at 1000 Hz	10-100 μH at 1000 Hz	20-200 μH at 1000 Hz
Standard Heatsink area (mm²):	1600	1600	1600	1600
Thickness (mm):	135	135	135	135
Protection Grade (IP):	IP55			
Mounting:	Vertically			
Cable Length:	300mm			
Weight (g):	460	670	920	1250
Heat Dissipation:	Although the use of proprietary heat sinks with lower thermal resistance is acceptable, up rating is not recommended. The use of proprietary heat sink compound to improve thermal conductivity is essential.			

Dimensions

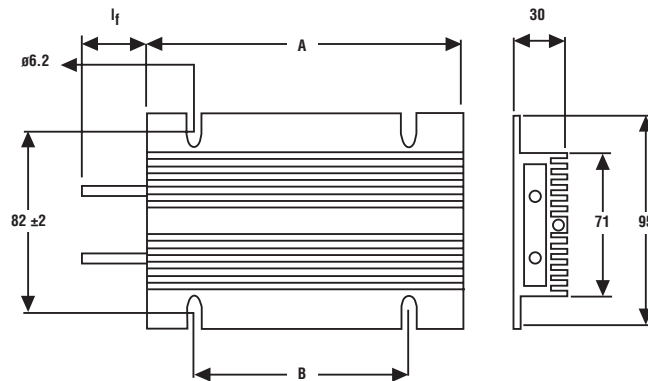

Type	CFH350	CFH500	CFH750	CFH1100
A	110 mm	160 mm	220 mm	320 mm
B	60 mm	110 mm	140 mm	240 mm

Type CFH Series

Derating Curve

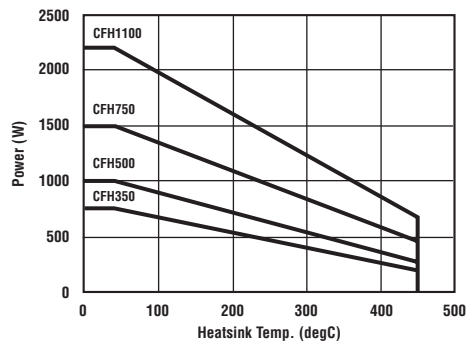

Pulse Energy

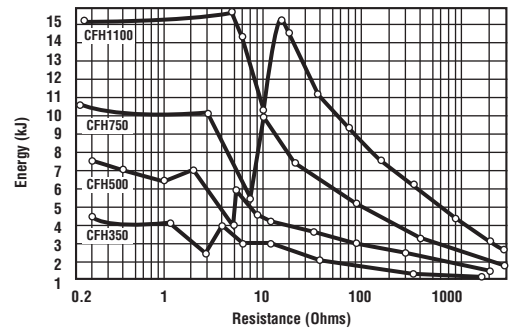

Surface Temperature Rise

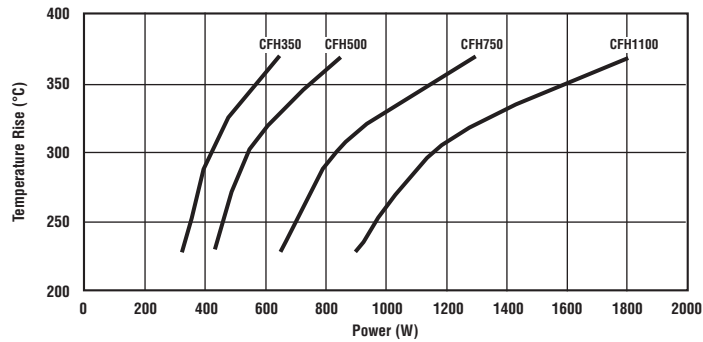

High Power Resistors

How to Order

CFH	750	680R	J
Common Part	Type	Resistance Value	Tolerance
CFH - Aluminium Housed Power Resistor	350 500 750 1100	0.1ohm (100mΩ) R10 1 ohm (1000mΩ) 1R0 1K (1000Ω) 1K0	J - 5%

Thick Film Power Resistors

Type BDS600 Series

Type BDS600 Series



With a maximum inductance of 80µH and a rated power of 600W (60°C Heatsink) in a 57mm x 60mm casing, the BDS600 offers high power density over a wide range of ohmic values (0R5 – 100K).

This high power density resistor is made from quality materials for optimum reliability and stability with very low partial discharge.

Tyco Electronics Components can test resistors to conform to relevant international, MIL or customer specifications, and will advise on the use of resistors for pulse applications (special pulse duty options available) and high voltage usage (high voltage designs available). The BDS600 offers a limiting element voltage of 5kVac rms, and 10kV isolation voltage (terminal to heatsink).

Resistors with 1% tolerance, alternative terminations or flying leads are available, and custom designs are welcome.

This product is available via distribution.

Key Features

- **600W in a 34.2cm² footprint**
 - Gives an impressive power density of 17.5W/cm²
- **Inductance < 80nH**
 - Virtually inductance-free
- **Wide resistance range: 0.5Ω to 100kΩ**
 - Coupled with 1% tolerance gives ultimate design flexibility
- **Multiple terminal configurations**
 - For demanding creep and clearance requirements
- **Partial discharge <5pC at 5kV**
 - Guaranteeing quality, reliability and long life

Characteristics - Electrical

Resistance Range:	0R5 – 100K	
Resistance Tolerance:	± 10%, 5% (Tighter by discussion)	
TCR:	± 150ppm/°C	
Rated Power:	Heatsink: 60°C	600W
Capacitance:	Parallel	40pF
	To Earth	110pF
Series Inductance:	<80nH (Maximum)	
Limiting Element Voltage:	5kV dc/ac rms	
Isolating Voltage:	(Terminal to Heatsink)	10kV ac rms
Single Shot Voltage:	1.5/50ms	12kV
Insulation Resistance:	(at 500V dc)	>1000MΩ
Partial Discharge:	at 7kV	<500pC
	at 5kV	<5pC
Heat Dissipation:	Although the use of proprietary heat sinks with lower thermal resistance is acceptable, up rating is not recommended. The use of proprietary heat sink compound to improve thermal conductivity is essential.	

Environmental

Endurance (Rated Power):	Full Load, 1000h, 25°C	ΔR 0.4% Typ
Humidity Load Life:	56 Days, 40°C, 95% RH	ΔR 0.25% Typ
Temperature Cycling:	-55°C to +125°C, 5cycles	ΔR 0.2% Typ
Storage Temp:	-55°C to +155°C	
Operating Temp:	-55°C to +140°C (200°C on req.)	
Short Term Overload:	1000W, 10s	ΔR 0.4% Typ
Vibration:	2-5000Hz/10g	ΔR 0.25% Typ
Bump:	40g 4000 bumps	ΔR 0.25% Typ

Mechanical

Terminal Size:	M5	
Terminal Torque (max.):	2Nm	
Creepage Distance:	48mm	
Air Gap:	To Heatsink	14mm
Heatsink Surface Finish:	R _a	< 6µm
Heatsink Flatness:	0.05mm	
Thermal Grease:	(0.05°C/Wmm)	Required
Weight:	160g	
Max. Mounting Torque:	1.8Nm	

Dimensions

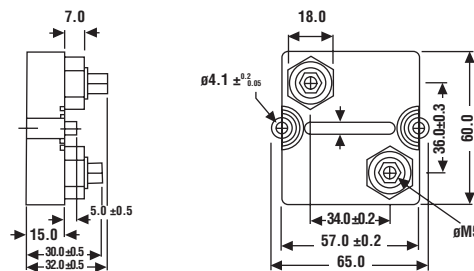

Applications

- Snubbing (Low inductance)
- High Frequency
- Filter (Low inductance)
- Balancing
- High Voltage

Derating Curve

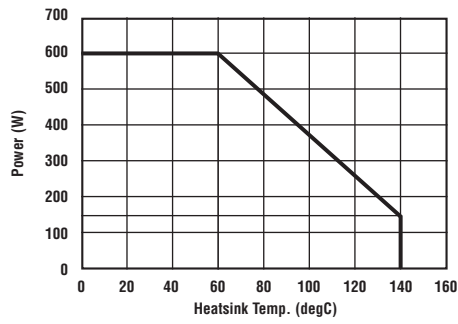

Pulse Energy

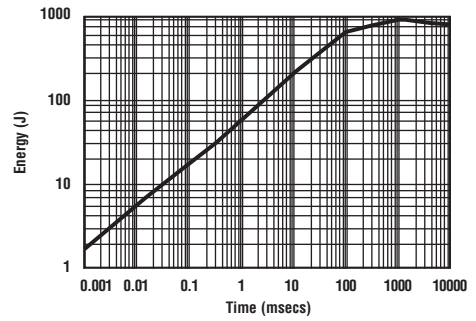

Power Overload

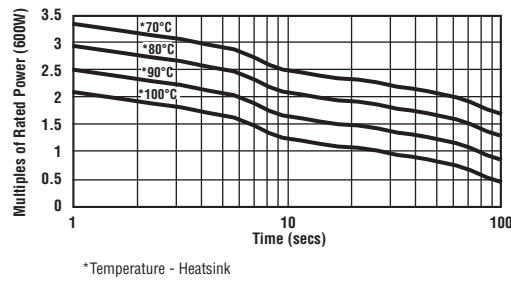

How to Order

BDS 2	A	600	1K0	J
Common Part	Circuit Type	Power Dissipation	Resistance Value	Tolerance
BDS 2 (2 Terminal)	A: Standard	600 - 600 Watts	0.5Ω (500mΩ) R50 1Ω (1000mΩ) 1R0 1K (1000Ω) 1K0	F - 1% J - 5% K - 10%

High Power Resistors

Bespoke Solutions

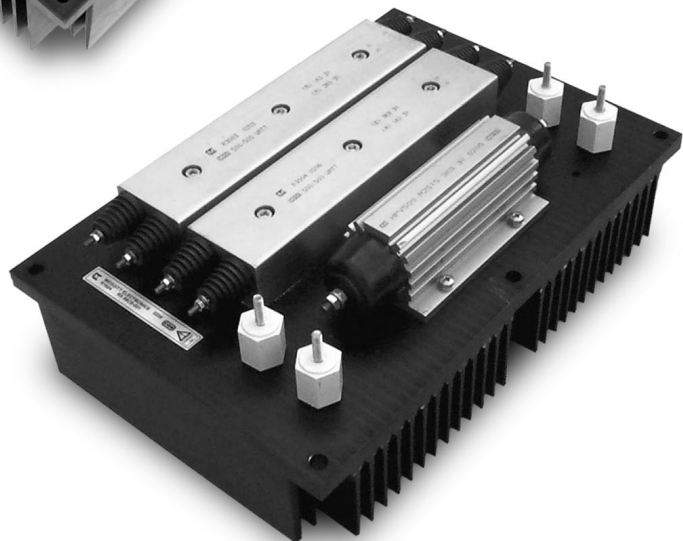
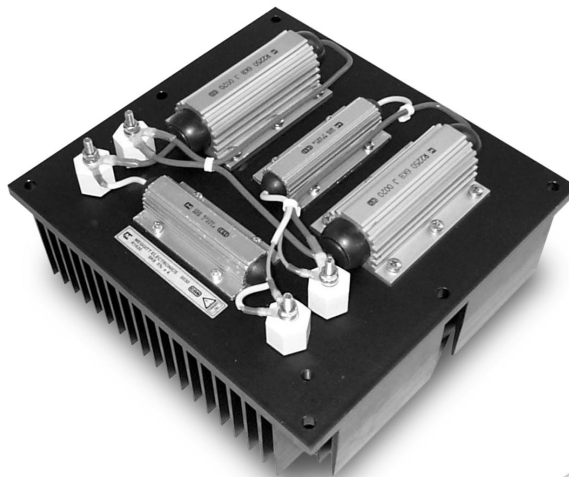
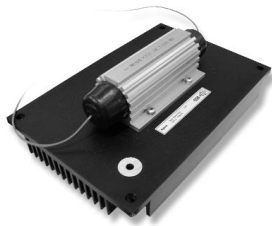

Tyco Electronics Components is pleased to offer customers the opportunity to specify resistor/heatsink assemblies to meet the most demanding applications. With the assistance of our Engineering team, you can create the optimum solution to suit your application. Our fully assembled, 'drop-in' assemblies give you complete flexibility to select resistors, heatsink type, cables, terminal posts, fixings and connectors to meet your own specification.

Key Features

- **Bespoke Solution**
 - Can be treated as a component not an assembly
- **Engineered From Specification to Completion**
 - We turn your specification into a drop-in solution
- **Complete Flexibility**
 - A wide range of resistors, heatsinks, terminal posts, fixings, wiring harnesses and connectors to suit every application
- **Convection or Water Cooling**
 - Designed to meet your performance and cost requirements
- **Reduce Cabinet Temperature for End-User**
 - Increases component life and system reliability

Applications

- Rail
- Marine
- Power Transmission and Distribution
- Electrical Machinery
- Capacitor Charging and Discharging
- Crowbar
- Filter
- Braking

How to Order

Heatsink assemblies are custom designed to meet a specific application. Tyco Electronics Components will allocate a specific part number – Please discuss with our Technical Sales Staff.

Customisation Capability

As a leading manufacturer of resistive products, Tyco Electronics serves a wide range of sectors with both standard and custom-designed solutions. Products are designed to meet demanding environmental, safety and cost criteria. Core markets include industrial machinery, transportation, marine, aerospace, electrical appliances, automotive and commercial.

Tyco Electronics' custom capability includes bespoke product developments as well as product modifications. Our experienced design teams work closely with our customers' engineering personnel to design advanced products that meet their exact requirements. The complete process from design to product delivery is completed to agreed timescales and budgets.

Materials used are of the highest quality and selected for optimum stability and reliability. Manufacturing processes include thick film, thin film, wire-wound and foil technology. Core processes can be adapted to achieve low or high resistive values. Examples of recent product developments include a combination of unique thick film and wire-wound resistors used in the propulsion system of the new generation destroyer, and a specially designed braking resistor used in the actuation system of fly by wire airliners.

Standard products are available in numerous styles and technologies and offer complete flexibility - including mechanical customisation for heatsinks, terminal posts, fixings, wiring harnesses and connectors. The base technology and materials can be adapted to suit any specific electrical requirements such as reduced temperature co-efficient, close tolerances, high voltage requirements, overload and adiabatic demands within space and internal temperature constraints.

The customisation and development programme also includes in-house product testing in our own R & D laboratory. The range of tests can be designed in conjunction with customer specifications to include cyclic rated power and overload testing, adiabatic (single shot and frequency) testing, environmental, mechanical and repetitive pulse testing. Qualification testing is carried out to a proven procedure and the product development stages are well documented and approved by a design approval team.

As part of our design services Tyco Electronics works with customers at their own premises to compare test results and calibrate equipment to achieve equal results. 3D visualisation of the end product is available so that our customer and our design team have a full understanding from very early on in the project, what the final product will look like.

Last but not least, Tyco Electronics offers a variety of packaging options as well as special cases and configurations. Options on cooling systems, custom lead formations, matched resistance solutions, custom windings and foil technology in stamped or etched solutions are available. We can also provide a variety of product insulations and coatings for a range of ceramic cores in rods, tubes or flat substrates.

Our design team is waiting for the opportunity to discuss your specifications and provide you with prompt, cost effective solutions to meet your ever changing business needs.

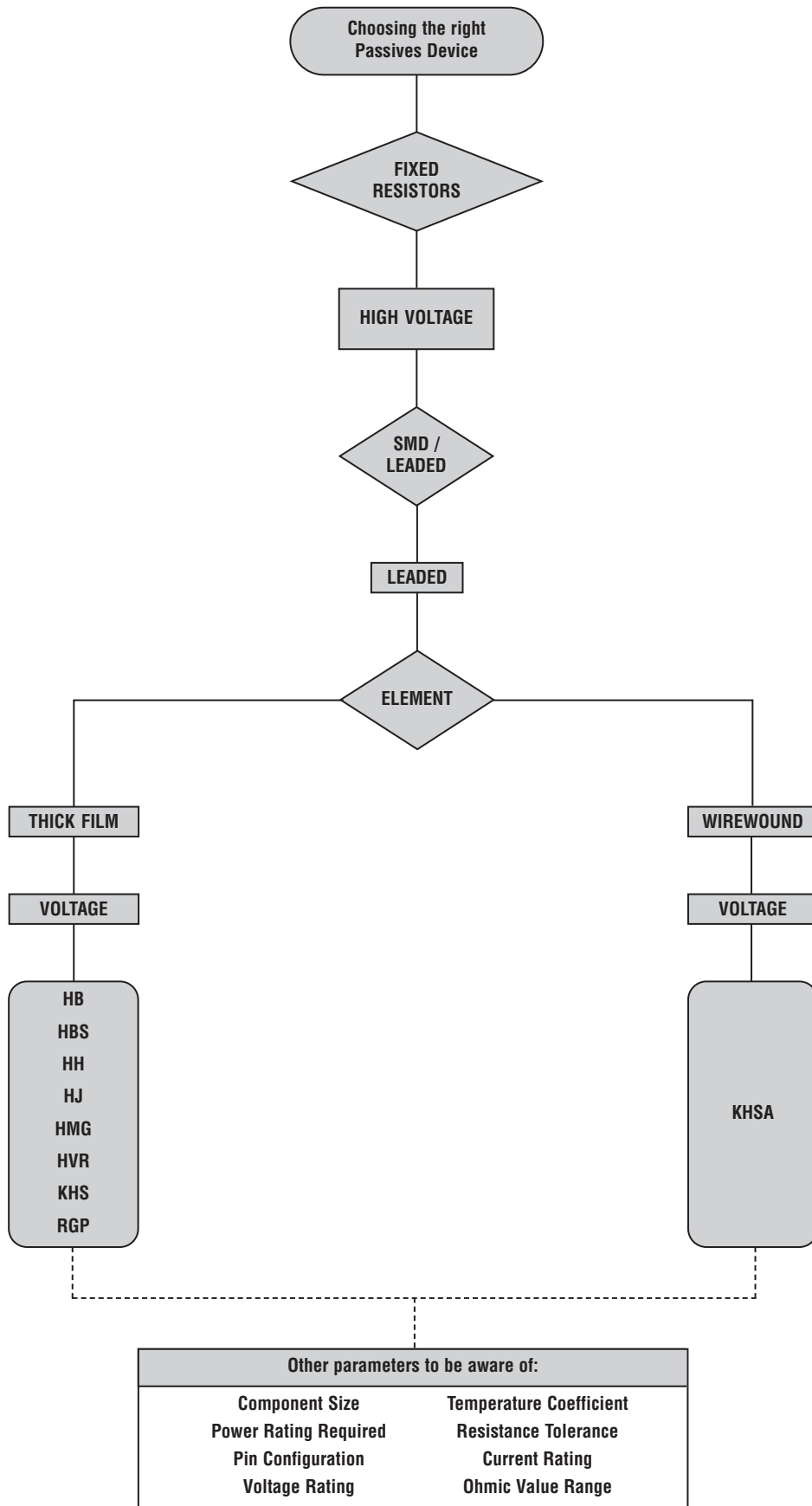

Product Overview

Tyco Electronics has been manufacturing its CGS brand of power resistors for over 50 years.

We have an extensive range of high voltage products in power ratings from 0.25 watt to 100 watt and with operating voltages up to 50kV. Ohmic values start from as low as 10 milliohms and reach 10 Gigaohms in certain ranges.

Our choice of technology includes thick film and Wirewound products. Our extensive standard range can be customised to include housings, leads, cables, terminations and they can be packaged into special cases and configurations.

All our products are tested at our in-house facility to ensure long term stability and endurance and adherence to our own rigorous specifications.

- High Voltage Withstand
- High Surge Energy Rating
- Wide Resistivity Range
- Extensive range of wattages
- Custom Design Solutions Available
- Wide range of Technologies
- In House Test Facility
- Highly qualified and experienced design team
- Compact sizes available
- Brand name CGS

Max Power Rating Watts	Ohmic Value Range	Tolerance	Working Voltage	Family	Page
0.25	1M-100M	5	250V	HMG	110
4	1M0-10G	5-10	15kV	RGP	111
3	100K-100M	0.1-0.25	10kV	HJ	112
6	100K-2G0	1-10	20kV	HH	113
4	1K0-1G0	1-5	15KV	HB	114-115
50/100	2K0-1G0	1-10	50KV	HVR	116-117
50	R01-100K	0.5-10	1.25KV	KHS	118-119

High Value Resistors

Type HMG Series

Type HMG Series

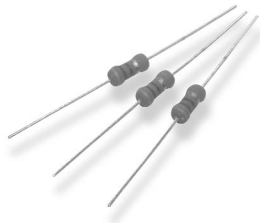

The Tyco Electronics Components Type HMG resistor is suited to applications requiring small size, high voltage, high impedance and high stability. Consistent quality and reliability is achieved via a metal film deposition on a high purity ceramic core. Multi layer epoxy coating offers excellent environmental protection.

The HMG Series is attractively priced and particularly well suited to use as voltage dividers, in X ray equipment, and in high voltage power supplies.

Key Features

- Small Dimensions
- High Power-Size Ratio
- Values up to 500 Meg
- Flameproof Construction
- Temperature Coefficient 100ppm/°C or 250ppm/°C
- All Product Banded

Characteristics - Electrical

	HMG25				HMG50				HMG100			
	100ppm/°C		250ppm/°C		100ppm/°C		250ppm/°C		100ppm/°C		250ppm/°C	
T.C.R.:	±1.0		±5.0		±1.0		±5.0		±1.0		±5.0	
Tolerance:	±1.0	±5.0	±1.0	±5.0	±1.0	±5.0	±1.0	±5.0	±1.0	±5.0	±1.0	±5.0
Resistance Range (Ω):	100K-10M	100K-10M	100K-50M	100K-50M	100K-30M	100K-30M	100K-50M	100K-100M	100K-50M	100K-100M	100K-50M	100K-500M
Power Rating (W):	0.25				0.5				1.0			
Max. Working Voltage (V):	250				500				750			
Max. Overload Voltage (V):	500				1000				1500			
Rating Ambient Temp (°C):	+70											

Environmental

Operating Temperature Range:	-55°C to +125°C
------------------------------	-----------------

Dimensions

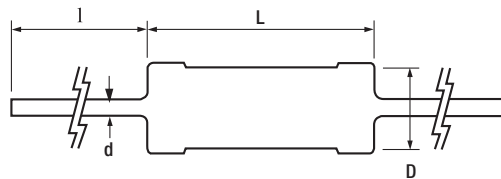

Style	L	D	l	d
HMG25	6.4 ± 0.8	2.3 ± 0.5	27 min.	0.6 ± 0.1
HMG50	9.5 ± 1.0	3.5 ± 1.0	38 ± 3	0.8 ± 0.1
HMG100	14.2 ± 1.6	4.8 ± 1.0	38 ± 3	1.0 ± 0.1

Pack Quantities - 2000 pieces

Power Derating Curve

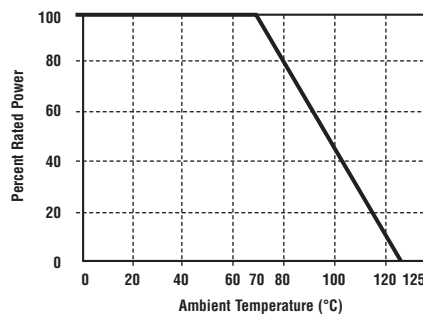

How to Order

HMG	25	10M	J
Common Part	Size	Resistance Value	Resistance Tolerance
HMG - High Value Metal Film Resistor	25 - 1/4 Watt 50 - 1/2 Watt 100 - 1 Watt	1 M Ohm (1000000 Ohms) 1M0 10M Ohm (10000000 Ohms) 10M	F - 1% J - 5%

Type RGP Series

Type RGP Series



Metal glaze resistors are manufactured using thick film techniques. The ceramic slugs have the thick film applied, the film is fired and end caps are forced onto the slugs, the resistive element is spiralled to value and lead wires are welded onto the end caps. Four layers of coating are applied - the first being a phenolic resin, the other three being epoxy.

Key Features

- The thick film is suitable for the manufacture of very high resistance values and for high voltage working components.
- The combination of high values and high working voltage makes these components ideally suited for such applications as TVs, electrical measuring equipment etc..
- Thick film metal glaze series for high ohmic values and high voltage surge rating with a range up to 10 Gohm.
- Product Supplied in Ammo Packs
- Legend Marked*

Characteristics - Electrical

	*RGP0207CH	RGP50	RGP100	RGP200	RGP300	RGP400
Rated Power @ 70°C (W):	0.25	0.5	1	2	3	4
Resistance Range (ohms) Min:	1M0	1M0	1M0	1M0	1M0	1M0
Max:	1G0	3G0	5G0	5G0	10G	10G
Tolerance (%):	5 10					
Code Letter:	J K					
Temperature Coefficient Max (ppm/°C):	±350					
Selection Series:	E24					
Limiting Element Voltage (V):	750	1K0	1K5	5K0	10K	15K
Maximum Overload Voltage (V):	1K0	1K5	2K5	7K5	15K	20K
Operating Temperature Range (°C):	-55 to +155					
Climatic Category:	55/155/56					
Voltage Coefficient (±%/V):	0.005					
Typical Noise at 47Mohm:	0.75					
Dielectric Strength (V):	300					
Insulation Resistance (Mohms):	1000					

Dimensions

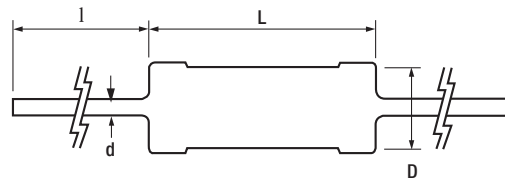

Style	L ± 1	D ± 0.5	d ± 0.1	l ± 2
*RGP0207CH	6.5	2.5	0.6	28
RGP50	13.0	4.5	0.8	38
RGP100	14.5	5.5	0.8	38
RGP200	27.0	7.0	0.8	38
RGP300	42.0	7.0	0.8	38
RGP400	52.0	8.0	1.0	38

* Product supplied with a 4 colour band

Derating Curve

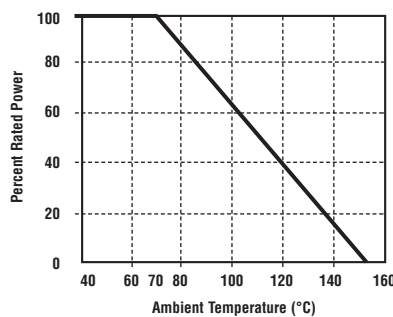

How to Order

RGP	0207	J	100R
Common Part	Style	Tolerance	Value
RGP - Metal Glaze Fixed Resistor	0207 - 0.25W 50 - 0.5W 100 - 1W 200 - 2W 300 - 3W 400 - 4W	J - 5%	100 ohm (100 ohms) 100R 1K0 (1000 ohms) 1K0 100K ohm (100,000 ohms) 100K

High Voltage Resistors

High Precision / High Voltage Resistors

Type HJ Series

Type HJ Series



The HJ type resistors have higher reliability when they are mounted on board, and excellent long term stability.

These are used mainly in semi-conductor equipments, X-ray apparatus, and many other measuring instruments.

Key Features

- Low TCR's
- Close Resistance Tolerances
- Small compact size
- High Reliability
- Excellent long-term stability
- High resistance to pulse voltages
- Special Coatings for High Humidity
- High thermal shock resistance when mounted to PCB

Characteristics - Electrical

Type	Power Rating @ 25°C (W)	Max. Working Voltage DC (kV)	Impulse Voltage (kV) 1.2 x 50 Microseconds	Resistance Range (Ohms)	Resistance Tolerance (%)	Temperature Coefficient (ppm)
HJ55	0.25W	0.75	1.5	100K-100M	0.1, 0.25	±25, ±50, ±100
HJ60	0.5W	1.5	3.0	100K-100M	0.1, 0.25	±25, ±50, ±100
HJ65	1.0W	2.0	4.0	100K-100M	0.1, 0.25	±25, ±50, ±100
HJ70	2.0W	5.0	10.0	100K-100M	0.1, 0.25	±25, ±50, ±100
HJ80	3.0W	10.0	20.0	1M-100M	0.1, 0.25	±25, ±50, ±100

Environmental

Test Item	Characteristics	Test Method
Operating Temperature Range:	-55°C to +150°C	
Short Term Overload:	±0.1%	Rated Voltage x 2.5 applied for 5 seconds
Resistance to Soldering Heat:	±0.1%	260°C for 10 seconds or 380°C for 3 seconds
Thermal Shock:	±0.1%	-55°C to +150°C, 5 cycles
Long Term Stability:	±0.3%	At normal temperature and humidity for 10,000 hours without load
Moisture Resistance:	±0.3%	40°C 90 ~ 95%RH for 1,000 hours exposure without load
Load Life:	±0.5%	25°C Rated power x $\frac{1}{2}$ for 1,000 hours
Temperature Coefficient:	"D" ±25ppm "C" ±50ppm "Z" ±100ppm	The test data is based on a temperature difference of 50°C (reference temperature 25°C; measurement temperature, 75°C)

Derating Curve

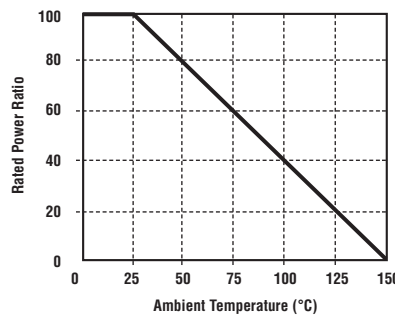

Dimensions

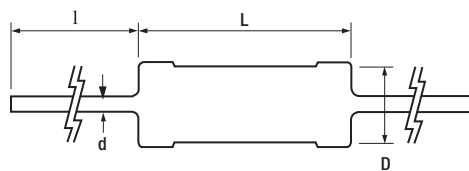

Style	D ± 1	L ± 1.0	d ± 0.05	l min
HJ55	3.0	9.0	0.6	38
HJ60	4.5	13.0	0.8	38
HJ65	4.5	14.5	0.8	38
HJ70	5.5	26.5	1.0	38
HJ80	8.5	42.0	1.0	38

How to Order

HJ55	100K	B	D
Common Part	Resistance Value	Tolerance	T.C.R.
HJ55 HJ60 HJ65 HJ70 HJ80	100K Ohm (100,000 Ohms) 100K 1 Meg Ohm (1,000,000 Ohms) 1M0	B - 0.1% C - 0.25%	D - ±25ppm C - ±50ppm Z - ±100ppm

High Voltage Resistors

Type HH Series

Type HH Series



The HH type resistors offer a very stable high voltage resistor in a compact package with excellent pulse withstand capability.

These are used mainly in physical and chemical measuring instruments, X-ray apparatus, electron microscopes and other high voltage industrial applications.

Key Features

- Low TCR's
- Low Resistance Tolerances
- Small compact size
- Up to 6 Watts Dissipation
- High Reliability
- Excellent long-term stability
- High resistance to pulse voltages
- High thermal shock resistance when mounted to PCB
- Power derates to zero at 150°C

Characteristics - Electrical

Type	Power Rating @ 25°C (W)	Max. Working Voltage DC (kV)	Impulse Voltage (kV) 1.2 x 50 Microseconds	Resistance Range (Ohms)	Resistance Tolerance (%)	Temperature Coefficient (ppm)
HH55	0.5W	1.5	3.0	100K-50M	1.0, 2.0, 5.0, 10	±25
				100K-100M		±50
				100K-1G0		±100
HH60	1.0W	2.0	4.0	100K-100M	1.0, 2.0, 5.0, 10	±25
				100K-500M		±50
				100K-2G0		±100
HH65	2.0W	5.0	10.0	100K-100M	1.0, 2.0, 5.0, 10	±25
				100K-500M		±50
				100K-2G0		±100
HH70	3.0W	10.0	20.0	100K-100M	1.0, 2.0, 5.0, 10	±25
				100K-500M		±50
				100K-2G0		±100
HH80	4.0W	15.0	30.0	100K-500M	1.0, 2.0, 5.0, 10	±50
				100K-2G0		±100
HH120	6.0W	20.0	40.0	100K-500M	1.0, 2.0, 5.0, 10	±50
				100K-2G0		±100

Environmental

Test Item	Characteristics	Test Method
Operating Temperature Range:	-55°C to +150°C	
Short Term Overload:	$\Delta R \leq \pm 0.5\%$	Rated Voltage x 2.5 applied for 5 seconds
Resistance to Soldering Heat:	$\Delta R \leq \pm 0.2\%$	350°C for 3 seconds
Long Term Stability:	$\Delta R \leq \pm 0.5\%$	At normal temperature and humidity for 10,000 hours without load
Moisture Load Life:	$\Delta R \leq \pm 0.5\%$	40°C 90 ~ 95%RH for 1,000 hours
Load Life:	$\Delta R \leq \pm 0.5\%$	25°C Rated power x $\frac{1}{2}$ for 3,000 hours
Temperature Coefficient:	"D" ±25ppm "C" ±50ppm "Z" ±100ppm	The test data is based on a temperature difference of 100°C (reference temperature 25°C; measurement temperature, 125°C)

Dimensions

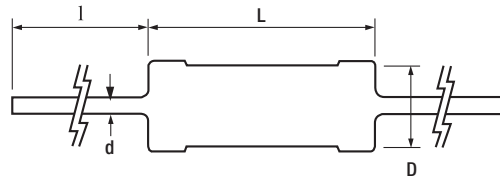

Style	D-mm	L-mm	d-mm	l-mm
HH55	4.5±1.0	13.0±1.0	0.8±0.05	38.0
HH60	4.5±1.0	14.5±1.0	0.8±0.05	38.0
HH65	5.5±1.0	26.5±1.0	1.0±0.05	38.0
HH70	5.5±1.0	42.0±1.0	1.0±0.05	38.0
HH80	8.5±1.0	52.0±1.0	1.0±0.05	38.0
HH120	8.5±1.0	77.0±1.0	1.0±0.05	38.0

How to Order

HH55	100K	F	D
Common Part	Resistance Value	Tolerance	T.C.R.
HH55 HH60 HH65 HH70 HH80 HH120	100K Ohm (100,000 Ohms) 100K 1 Meg Ohm (1,000,000 Ohms) 1M0	F - 1% G - 2% J - 5% K - 10%	D - ±25ppm C - ±50ppm Z - ±100ppm

High Voltage Resistors

Type HB Series

Type HB Series

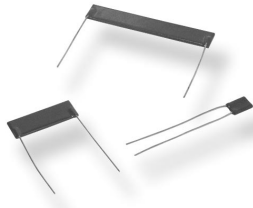

Tyco Electronics Components is a leading European supplier of standard and custom designed high value/high voltage resistors for high voltage, industrial, control, medical and general-purpose use.

The HB is a tough epoxy coated high voltage resistor, with axial or radial leads, values up to 1G Ohm and an operational voltage to 20kV as standard and 30kV to order.

The resistors are made from quality materials for optimum reliability and stability. Tyco Electronics Components can test resistors to conform to relevant international, MIL or customer specifications.

Tyco Electronics Components is happy to advise on the use of resistors for high frequency applications and to supply information for high voltage use.

Key Features

- Up to 15kV Element Voltage
 - Unique specification for the most demanding applications
- High Ratio of Size to Power
 - The solution to your PCB population problems
- Wide resistance range: 1KΩ to 1GΩ
 - Coupled with 1% tolerance gives ultimate design flexibility
- Established Product with Proven Reliability
- Low Inductance
 - For the fastest switching speeds

Applications

- High Voltage
- Voltage Divider
- Surge
- Filter
- Balancing
- Inrush Limiting

Characteristics - Electrical

	HBA	HB1	HB3
Power Dissipation - Power @ 20°C (W):	0.8	2.0	4.0
@ 70°C:	0.4	1.0	2.0
Ohmic Value - Min (Ohms):	1K	10K	10K
Max:	120M	1G	1G
Resistance Tolerance (%):	1%, 2%, 5%	1%, 2%, 5%	1%, 2%, 5%
Maximum Working Voltage - DC or ACrms (Volts):	1kV	7.5kV	15kV
Insulation Resistance - Epoxy Coated, @500V dc (Ohms):	>10 ⁶ MΩ	>10 ⁶ MΩ	>10 ⁶ MΩ
Load Stability - 1000hr's @ 70°C (%):	±0.5%	±0.5%	±0.5%
Temp. Rapid Change - -55°C to 125°C for 5 cycles (ΔR):	±0.1%	±0.1%	±0.1%
Endurance - 1000 Hours @ 200°C (ΔR):	<=2%	<=2%	<=2%
Resistance to Soldering Heat - 350°C for 3.5seconds (ΔR):	0.05%	0.05%	0.05%
Temperature Coefficient (ppm/°C):	±100ppm/°C	±100ppm/°C	±100ppm/°C
(±20ppm/°C available to special order)			
Voltage Coefficient:	Negligible up to 100K		Negligible up to 200K
	Increasing to 0.02ppm/Volt at 800K		Increasing to 0.01ppm/Volt at 1M0
	Increasing to 1.0ppm/Volt at 5M0		Increasing to 1.0ppm/Volt at 10M
	Increasing to 2.0ppm/Volt at 50M		Increasing to 2.0ppm/Volt at 100M
	Increasing to 8.0ppm/Volt at 100M		Increasing to 8.0ppm/Volt at 1000M
Ambient Temperature Range (°C):	-55 to 125	-55 to 125	-55 to 125
Long Term Damp Heat (%):	0.25%	0.25%	0.25%
(Steady state 56 Days 95% RH at 40°C)			
Noise (Quantech) Dependent on Resistor Type and Value:	-20dB (0.1μ V/V) at lower values +10dB (3.3μ V/V) at higher values		
Encapsulation:	Epoxy coating (Optional)		
Solvent Resistance:	Print will withstand the action of all commonly used industrial solvents.		
Lead Material:	Tinned copper wire		
Lead Length:	Minimum 20mm		
Lead Diameter:	Nominal 0.6 ± 0.05mm		

Dimensions - Type HBA, HB1 & HB03

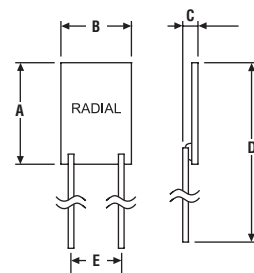

Type HB01 & HB03

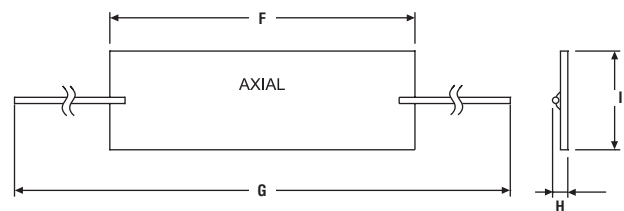

Type		A	B	C	D	E	F	G	H	I
HBA	Uncoated	10.2	7	1.75	60.2	5.0	-	-	-	-
	Epoxy Coated	12.5	8	2.6	60.5	5.0	-	-	-	-
HB01	Uncoated	8.4	26	1.5	33.8	22.9	26	66	1.5	8.4
	Epoxy Coated	10.4	26.5	3.0	35.8	22.9	26.3	66	3	9.2
HB03	Uncoated	8.4	51.1	1.5	33.8	48.3	51.1	91.1	1.5	8.4
	Epoxy Coated	10.4	52	3.0	35.8	48.3	53.5	91.1	3	9.6

Derating Curve

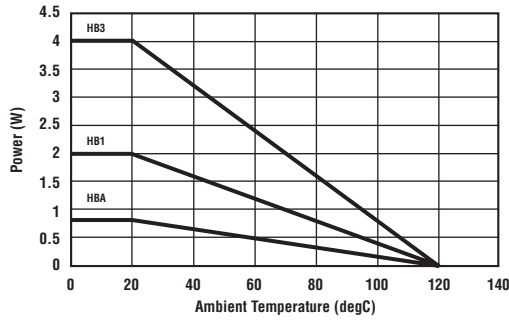

Surface Temperature Rise

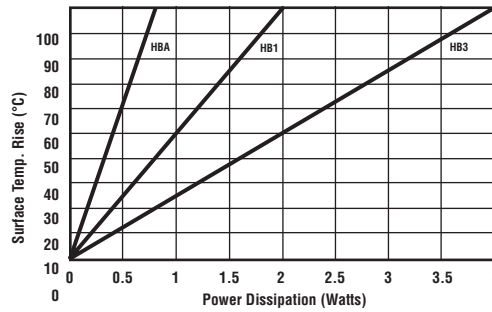

How to Order

HB	3	1K0	J	Z	R	E
Common Part	Power Rating @ 70°C	Resistance Value	Tolerance	Temp. Coefficient of Resistance	Lead Style	Coating Styles
HB- High Value / High Voltage Resistor	A - 0.4W 1 - 1.0W 3 - 2.0W	1Kohm (1000Ω) 1K0 1Mohm (1000000Ω) 1M0	F - 1% G - 2% J - 5%	Z - 100ppm	R - Radial Leads A - Axial Leads (HB1, HB3 only for Axial Leads)	E - Epoxy Blue Coating

Type HVR Series

Type HVR Series



Tyco Electronics Components is a leading European supplier of high specification power resistors for specialist applications. The HVR range consists of high power, high voltage resistors capable of operating up to 50kV (continuous) and dissipating 50W in air or 100W oil. The thick film resistor element is designed to minimise inductance and capacitance giving optimum performance at MHz frequencies, and resistance to high voltage surges. The resistors are made from quality materials for optimum reliability and stability. Tyco Electronics Components can test resistors to conform to relevant international, MIL or customer specifications. Tyco Electronics Components is happy to advise on the use of resistors for pulse applications and to supply information for high voltage use and low-ohmic value, alternative mountings and termination type.

Key Features

- **Highly Versatile Product**
 - Resistance values from 2kΩ to 1GΩ and a range of mounting options
- **50 kV Continuous Operating Voltage**
 - Unique specification for the most demanding applications
- **Low Inductance and Capacitance**
 - For high frequency applications into the MHz range
- **Established Product**
 - High stability with proven reliability

Applications

- High Frequency Switching (MHz)
- Balancing
- Voltage Divider
- High Voltage

Characteristics - Electrical

	HVR10	HVR20	HVR30	HVR50
Ohmic Value Min (Ω):	2k0	2k0	2k0	2k0
Max:	1G0	1G0	1G0	1G0
Resistor Tolerance - Standard (%):	10%	10%	10%	10%
Options (R<400M):	5%, 1%	5%, 1%	5%, 1%	5%, 1%
Power Dissipation at 20°C (W):	5W	15W	25W	50W
At 70°C:	3W	10W	15W	25W
In Oil at 20°C:	10W	30W	50W	100W
Continuous Operating Voltage Max (V):	10kV	20kV	30kV	50kV
Temperature Coefficient of Resistance				
20°C to 70°C (ppm/°C):	< ±300ppm/°C	< ±300ppm/°C	< ±300ppm/°C	< 300ppm/°C
Voltage Coefficient of Resistance - V > 100V (%):	< ±2%	< ±2%	< ±2%	< ±2%
Stability ΔR - 1000h Load Life (%):	< ±2%	< ±2%	< ±2%	< ±2%

Dimensions

Style B

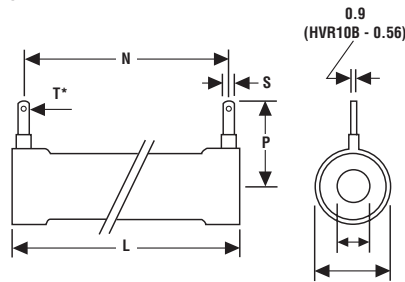

Style C

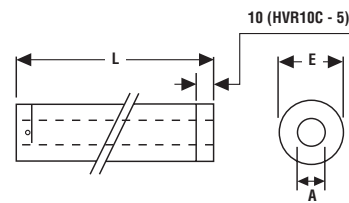

Style D

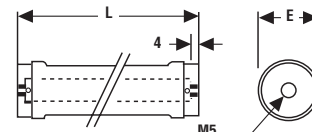
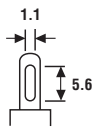

Style B

Type	A	E	L	N	P	S	T
HVR10	6.3	12.0	60.0	53.2	18.2	28	-
HVR20	10.0	22.6	120.0	109.0	27.0	4.8	2.4
HVR30	17.5	30.6	120.0	109.0	34.0	6.3	3.1
HVR50	17.5	30.6	240.0	229.0	34.0	6.3	3.1

Style C

Type	A	E	L	N	P	S	T
HVR10	6.3	10.5	60.0	-	-	-	-
HVR20	10.0	20.2	120.0	-	-	-	-
HVR30	17.5	28.2	120.0	-	-	-	-
HVR50	17.5	28.2	240.0	-	-	-	-

Style D

Type	A	E	L	N	P	S	T
HVR10	6.3	10.0	70.0	-	-	-	-
HVR20	10.0	21.5	140.0	-	-	-	-
HVR30	17.5	30.0	140.0	-	-	-	-
HVR50	17.5	30.0	260.0	-	-	-	-

Type HVR Series (continued)

Derating Curve

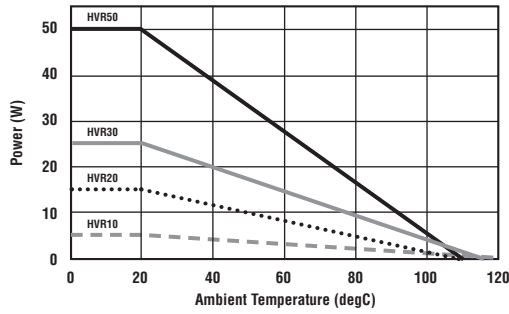

Surface Temperature Rise

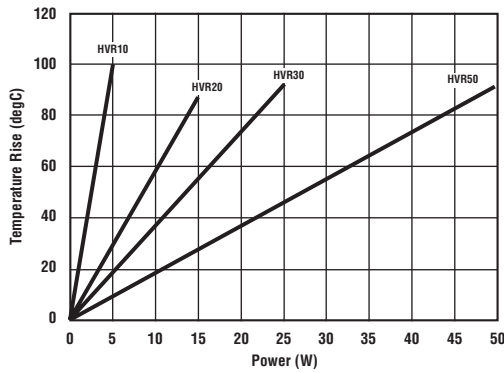

How to Order

HVR	10	B	2K	J
Common Part	Voltage Rating	Terminal Style	Resistance Value	Tolerance
HVR- Aluminium Housed Power Resistor	10 - 10kV 20 - 20kV 30 - 30kV 50 - 50kV	B - Steel Lugs C - Silver Ferrule D - Tapped Brass Ferrule	2kΩ (2000Ω) 2K 1MΩ (1x10 ⁶ Ω) 1M0 1GΩ (1x10 ⁹ Ω) 1G0	F - 1% G - 2% E - 3% J - 5% K - 10%

Aluminium Housed Power Resistors

Type KHSA Series

Type KHSA Series

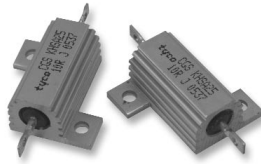

Tyco Electronics Components is the leading European supplier of standard and custom designed aluminium housed resistors for general-purpose use, power supplies, power generation and the traction industry. The KHSA range of extremely stable, high quality wire wound resistors is capable of dissipating high power in a limited space with relatively low surface temperature. The power is rapidly dissipated as heat through the aluminium housing to a specified heat sink. The KHSA offers increased dielectric strength over the standard range of HS resistors. The resistors are made from quality materials for optimum reliability and stability. Tyco Electronics Components can test resistors to conform to relevant international, MIL or customer specifications. Tyco Electronics Components are happy to advise on the use of resistors for pulse applications and to supply information for high voltage use and low-ohmic value, alternative mountings and termination type.

Key Features

- **Increased Dielectric Strength**
 - High voltage performance up to 1.25kV
- **Wide Resistance range: 0.01Ω– 100kΩ**
 - Coupled with 1% tolerance gives ultimate design flexibility
- **Broad Range of Options and Custom Design Capability**
 - The solution for your application
- **Proven Reliability at a competitive price**
 - Benefits from over 50 years of HS resistor design and manufacture

Characteristics - Electrical

	KHSA25	KHSA50
Dissipation @ 25°C with Heatsink (Watts):	25	50
Without Heatsink:	12.5	25
Ohmic Value Min (Ohms):	R01	R01
Max:	36K	100K
Maximum Working Voltage (DC or ACrms) Volts:	550V	1250V
Dielectric Strength (AC peak) Volts:	3.5kV	3.5kV
Insulation Resistance @ 500V (Ohms):	>10GΩ	>10GΩ
Stability (% resistance change, 1000 hours) (%):	≤ 2%	≤ 2%
Temperature Coefficient ppm/°C:	<±50ppm/°C	<±50ppm/°C
Environmental Category:	-55/200/56	-55/200/56
Long Term Stability:	For improvements in long-term stability, resistors must be derated as follows; for 50% of stated ΔR maximum dissipation must not exceed 70% of rating; for 25% of stated ΔR maximum, dissipation must not exceed 50% of rating	
Insulation Resistance:	Dry: 10GΩ minimum. After moisture test: 1GΩ minimum.	
Heat Dissipation:	Although the use of proprietary heat sinks with lower thermal resistance is acceptable, up rating is not recommended. The use of proprietary heat sink compound to improve thermal conductivity is recommended for optimum performance	
Specification:	Temperature coefficient below 100R, 50ppm/°C Temperature coefficient above 100R, 30ppm/°C Tolerance, 5% standard: 10%, 3%, 2%, 0.5% & 0.25% available Tolerance for values below R10, 10% standard	

Dimensions

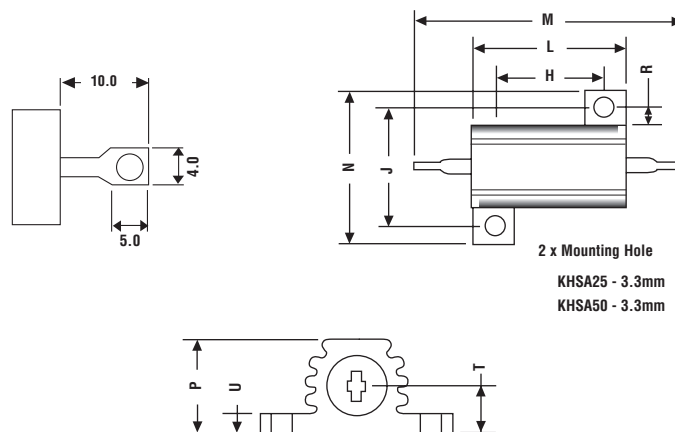

2 x Mounting Hole
KHSA25 - 3.3mm
KHSA50 - 3.3mm

Type	H±0.3	J±0.3	K±0.3	L Max	M Max	N Max	P Max	R Min	T±0.5	U Max
KHSA25	18.3	19.8	3.3	29.0	51.8	28.0	15.0	2.8	7.2	3.2
KHSA50	39.7	21.4	3.3	51.0	72.5	30.0	17.0	2.8	7.9	3.2

Applications

- High Voltage
- Filter
- Crowbar
- Braking
- Balancing
- Capacitor Charging & Discharging
- Electrical Machinery

Derating Curve

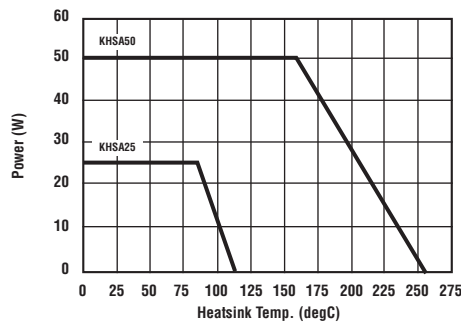

Pulse Energy

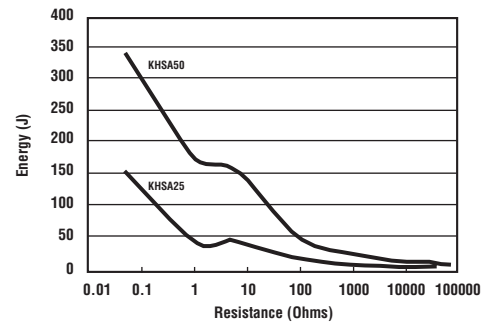

Power Overload

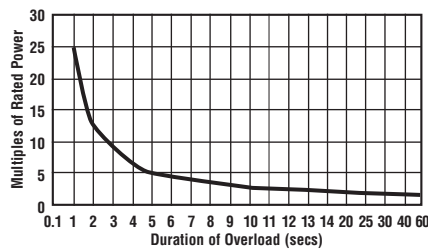

This graph indicates the amount that the rated power (at 20°C) of the standard KHSA Series resistor may be increased for overloads of 100mS to 60S

Surface Temperature Rise

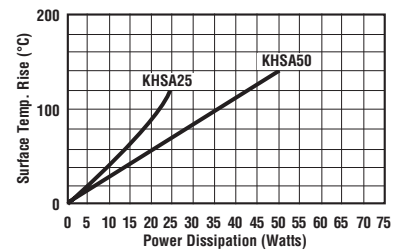

For resistor mounted on standard heatsink, related to power dissipation

How to Order

KHSA	50	680R	J
Common Part	Power Rating (Watts)	Resistance Value	Tolerance
KHSA - Aluminium Housed Power Resistor	25 50	0.1ohm (100mΩ) R10 1 ohm (1000mΩ) 1R0 1K (1000Ω) 1K0	F - 1% G - 2% E - 3% J - 5% K - 10%

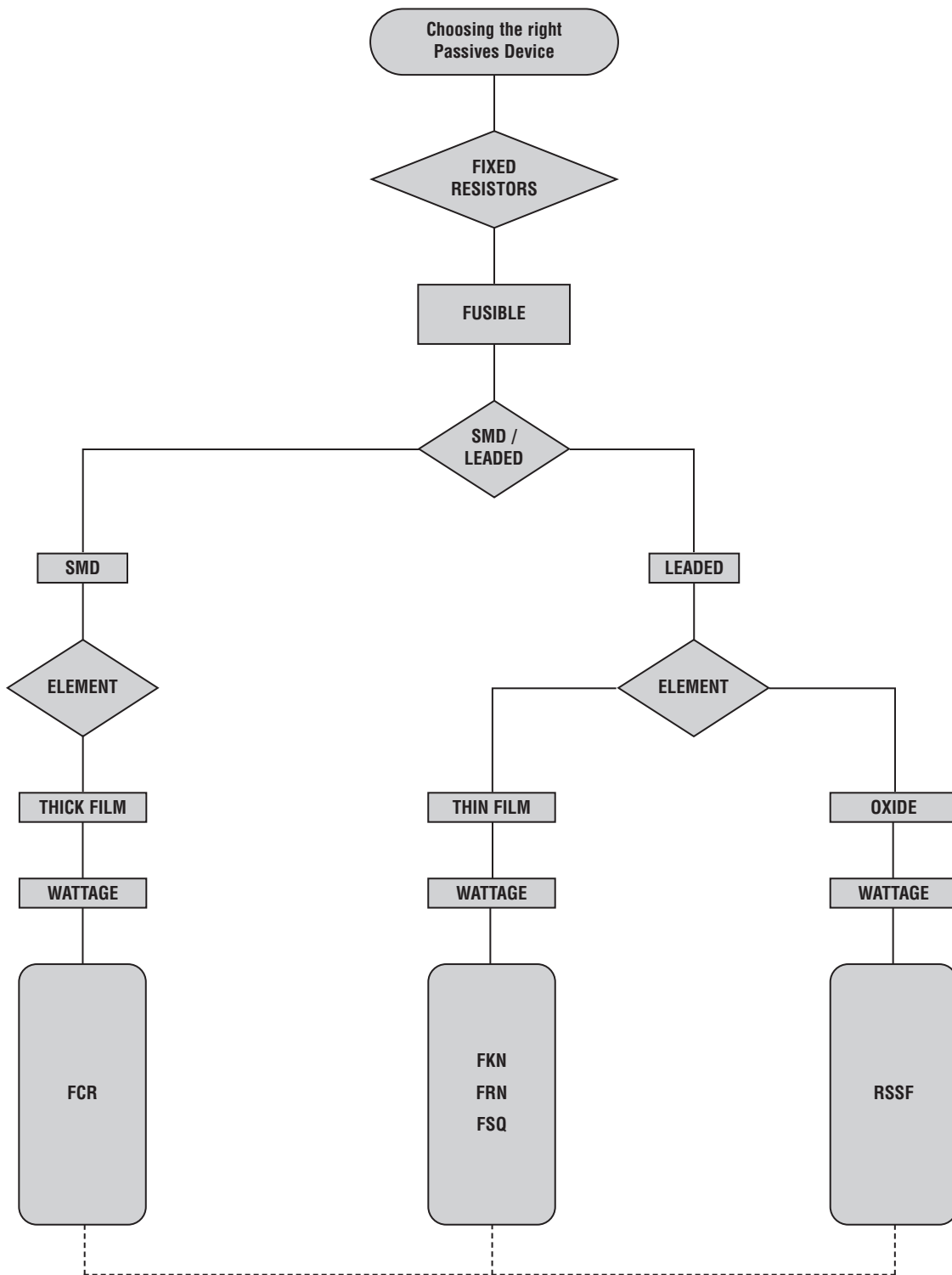

Other parameters to be aware of:	
Component Size	Temperature Coefficient
Power Rating Required	Resistance Tolerance
Pin Configuration	Current Rating
Voltage Rating	Ohmic Value Range

Fusible Resistors

Product Overview

The CGS and Neohm ranges of Fusible Resistors are designed to provide protection in safety critical and circuit protection applications.

Available in leaded and surface mount technology with permissible power rating to 10W, these devices use technologies in Film and Wirewound to give uniform fusing times. With completely flameproof construction the products are suitable for many applications.

- Surface Mount products down to 0805 size
- Power ratings to 10W
- Operating temperatures to 275°C
- High surge/overload capability
- Solvent resistant coatings
- Excellent long term stability

Max Power Rating Watts	Ohmic Value Range	Maximum Fusing Time	Tightest Tolerance	Family	Page
0.5W	1R0 - 100R	30s at 4W	5%	FCR	122-123
3W	R12 - 1K0	60s at 16 times rated power	5%	FRN	124-125
5W	R10 - 250R	Various	5%	FKN	126
10W	R10 - 150R	Various	5%	FSQ	127

Type FCR Series

Type FCR Series

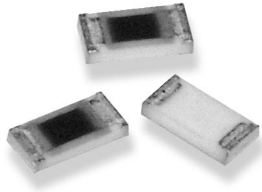

Precious metal terminations are screen printed onto a ceramic base and fired. The resistive element is screen printed and fired and the passivation layer added. Each resistor is trimmed to tolerance by sand blasting. The prescribed tile is broken into strips, the end plating is fired on and the strips broken into individual components. Final termination is made by electroplating.

Key Features

- Chip resistors with known fusible characteristics. These resistors will not produce flames or smoke during fusing.
- Suitable for battery operated circuits.
- Case sizes 0805, 1206 and 2010.
- FCR chip resistors are suitable for most applications, including high frequency operation.

Characteristics - Electrical

	0805	1206	2010
Rated Power @ 70°C (W):	0.1	0.125	0.5
Resistance Range (Ohms) Min:	1	1	1
Max:	51	100	100
Tolerance (%):	5		
Code Letter:	J		
Temperature Coefficient (ppm/°C):	1000		
Selection Series:	E24		
Operating Temperature Range (°C):	-55 to +125		
Climatic Category:	55/125/56		
Fusing Characteristics (W):			
10ms:		20	50
100ms:		8	17
Maximum Fusing Time (30 s):	2.0	2.5	4.0

Dimensions

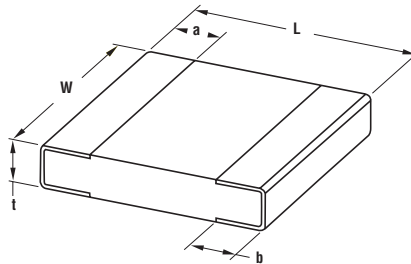

Style	L	W	t	a	b
0805	2.0 ±0.1	1.25 ±0.1	0.6 ±0.1	0.4 ±0.2	0.4 ±0.2
1206	3.2 ±0.2	1.6 ±0.2	0.6 ±0.1	0.5 ±0.3	0.5 ±0.25
2010	5.0 ±0.2	2.5 ±0.2	0.6 ±0.1	0.5 ±0.3	0.4 ±0.2/-0.1

Power Derating Curve

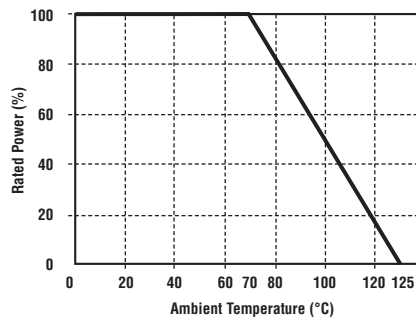

Fusible Chip Resistors

Type FCR Series (continued)

Mounting

The resistors are suitable for processing on automatic insertion equipment.

Marking

E24 series resistors are marked with a three digit code.

Packaging

All chip resistors are supplied on reels of 2000 or 5000 pieces.

Performance Characteristics

The evaluation of the performance characteristics is carried out with reference to IEC Specifications QC 400 000 and QC 400 600.

TEST REF	Tests	Test Requirements
4.24	Damp heat, steady state	±5%
4.25.1	Endurance at 70°C	0805 ±10% 1206, 2010 ±5%
4.13	Short Term Overload	±5%
4.19	Rapid change of temperature	±5%
4.18	Resistance to soldering heat	±3%

Storage

Unopened reels should be stored within a temperature range of +5°C to +25°C, separated from any dust, chemicals and solvent based materials. Non-adherence to this procedure could affect the solderability of this product.

How to Order

FCR	0805	J	1R0
Common Part	Size	Tolerance	Value
FCR - Fusible Chip Resistor	0805 1206 2010	J - ±5%	1 Ohm (1000 milliohms) 1R0 50 Ohms (50 ohms) 50R 100 Ohms (100 ohms) 100R

Type FRN Series

Type FRN Series

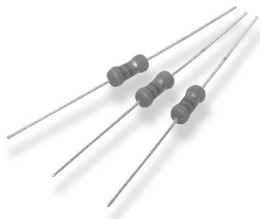

The resistive element comprises a resistive film sputtered onto a ceramic element. Metal end caps are force fitted to the element prior to spiralling. Tinned copper lead wires are welded to the end caps and the components are then coated with four layers of a flame-proof cement. All resistors are tested for value and tolerance. The technology allows the manufacture of custom fusible characteristics.

Key Features

- Superior quality resistors with fusing characteristics for overload conditions.
- Flame-proof during fusing.
- Ideal for use in safety-critical and circuit protection applications.
- These resistors fuse in less than 60 seconds at 16 times rated power. (See table)
- This series is UL approved.

Characteristics - Electrical

	FRN25	FRN50S	FRN100S	FRN200S	FRN300S
Rated Power @ 70°C (W):	0.25	0.5	1	2	3
Resistance Range (Ohms) Min:	R12	R12	1R0	R30	R30
Max:	12K	12K	1K0	1K0	1K0
Tolerance (%):	5				
Code Letter:	J				
Temperature Coefficient (ppm/°C):	±350			±200 (-30°C to +150°C)	
Selection Series:	E12				
Limiting Element Voltage:	250	250	300	300	300
Max Permitted Element Voltage:	250	250	300	350	350
Max Overload Voltage:	500	500	600	600	600
Max Intermittent Overload Voltage:	500	500	600	600	600
Max Withstand Voltage After Fusing:	300	350	450	450	450
Operating Temperature Range (°C):	-55 to +155				
Climatic Category:	55/155/56				
Insulation Resistance Min Dry (ohms):	1000M				

Dimensions

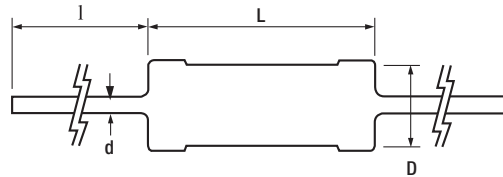

Style	L	D	d Nom	l
FRN25	6.3 ±0.5	2.3 ±0.3	0.54	25.0
FRN50S	6.3 ±0.5	2.3 ±0.3	0.54	25.0
FRN100S	9.0 ±0.5	3.2 ±0.5	0.54	25.0
FRN200S	11.0 ±1.0	4.5 ±1.0	0.70	25.0
FRN300S	15.0 ±1.0	5.5 ±1.0	0.80	25.0

Derating Curve - FRN25, FRN50S, FRN100S

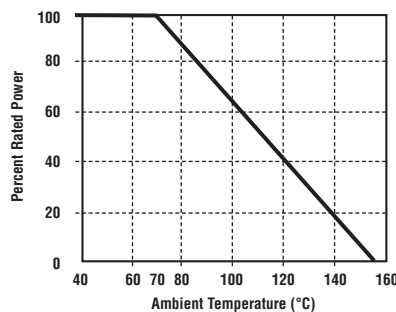

FRN200, FRN300

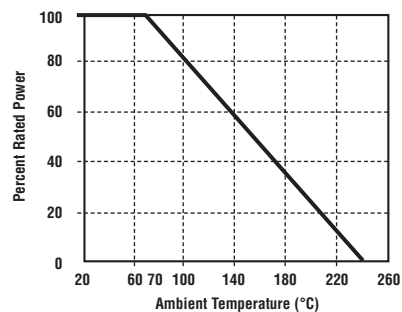

Type FRN Series (continued)

Mounting

The resistors are suitable for processing on automatic insertion equipment.

Marking

The resistors are marked with a 3 colour band code indicating the value.
The fourth band indicates the tolerance.
The fifth band denotes a fusible resistor.

Packaging

FRN25, FRN50S and FRN100S are normally supplied taped in 'ammo' boxes of 4,000 pieces.
FRN200S and FRN300S resistors are normally supplied taped in 'ammo' boxes of 1,000 pieces.
Other package styles available on request.

All tape specifications are in accordance with IEC 286-1.

Fusing Characteristics

Overload Power	Maximum Fusing Time
16 times rated power	60 seconds
20 times rated power	40 seconds
24 times rated power	30 seconds
28 times rated power	20 seconds
32 times rated power	15 seconds

Performance Characteristics

The evaluation of the performance characteristics is carried out with reference to IECQ specifications QC 400 000 and QC 400 100.

TEST REF	Long Term Tests $\pm(5\% + 0.5 \text{ ohm})$
4.23	Climatic sequence
4.24	Damp heat, steady state
4.25.1	Endurance at 70 °C
4.25.3	Endurance at 155 °C
TEST REF	Short Term Tests $\pm(1\% + 0.05 \text{ ohm})$
4.13	Overload
4.16	Robustness of terminations
4.18	Resistance to soldering heat
4.19	Rapid change of temperature
4.22	Vibration

How to Order

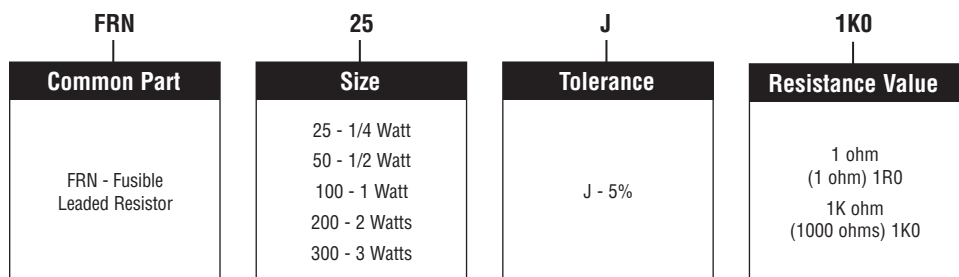

Fusible Resistors

High Power Resistors (Fusible)

Type FKN Series

Type FKN Series



There are some similarities between resistors and fuses in material and structure. Fusible Resistors perform both functions, as a resistor in normal conditions and as a fuse when abnormal currents are applied, so as to protect machinery and equipment. Cost savings are apparent as one component is eliminated.

The FKN Fusible Resistor series is produced with precision techniques, enabling precise and stable fusing times.

Key Features

- Protects Circuit Boards & Designs
- Small Size, Competitive Price
- Excellent Long Term Stability
- Complete Flame Proof Construction
- Solvent Proof
- Resistant to High Temperature
- Low Temperature Coefficient
- Uniform in Fusing Time

Characteristics - Electrical

Operating Temperature (°C):	-55 to +275
Resistance Temperature Coefficient (°C):	-30 to +150 ±300ppm/°C
Short Time Overload:	2.5 times of rated voltage for 5 seconds ΔR < ±2%
Insulation Resistance:	500V Megger - 1000Mohms
Temperature Cycle (°C):	-30 to +85 for 5 cycles ΔR < ±1%
Load Life:	70°C on-off cycle 1000 hours ΔR < ±5%
Moisture-Proof Load Life:	40°C 95% RH on-off cycle 1000 hours ΔR < ±5%
Solder Pot:	270°C for 3 seconds ΔR < ±1%
Incombustibility:	16 times of rated wattage for 5 minutes - Not Flamed
Maximum Working Voltage:	500V

Fusing Characteristics

Fusing times can be decided by consultation with our design team to meet application requirements.

Derating Curve

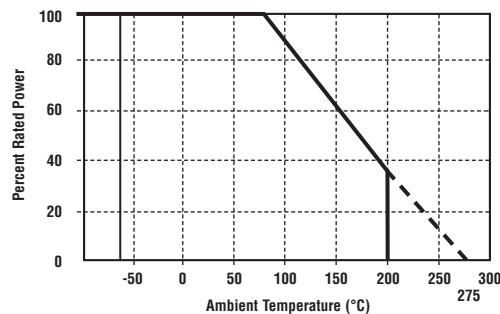

For resistors operated in ambient temperatures above 70°C, power rating must be derated in accordance with this curve.

Dimensions

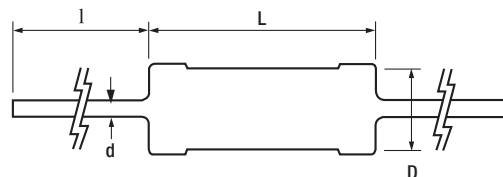

Rated Wattage	Dimensions				Resistance Range (Ohms)
	L±1.5	D±1.0	l±3.0	d±0.05	
1W	9.0	4.0	30.0	0.65	0.1-22
2W	11.0	5.0	30.0	0.80	0.1-60
3W	13.0	5.5	38.0	0.80	0.1-100
5W	19.0	6.5	38.0	0.80	0.3-250

How to Order

FKN	3	R10	J	T
Common Part	Power Rating	Resistance Value	Tolerance	Packaging
FKN - Silicone Cement Coated	Example 3 - 3 Watts	0.1 Ohm (100 milliohms) R10 1.0 Ohm (1000 milliohms) 1R0 50 Ohms (5000 milliohms) 50R	J - ±5%	T - Ammo Boxed

High Power Resistors (Fusible)

Type FSQ Series

Type FSQ Series



There are some similarities between resistors and fuses in material and structure. Fusible Resistors contain both functions, as a resistor in normal conditions and as a fuse when abnormal currents are applied, so to protect machinery and equipment. Cost savings are apparent as one component is eliminated.

The FSQ Fusible Resistor series is produced with precision techniques, enabling precise and stable fusing times.

Key Features

- Protects Circuit Boards & Designs
- Small Size
- Excellent Long Term Stability
- Complete Flame Proof Construction
- Resistant to High Temperature
- Low Temperature Coefficient
- Uniform in Fusing Time

Characteristics - Electrical

Operating Temperature (°C):	-55 to +275
Resistance Temperature Coefficient (°C):	-30 to +150 ±300ppm/°C
Short Time Overload:	2.5 times of rated voltage for 5 seconds ΔR < ±2%
Insulation Resistance:	500V Megger - 1000Mohms
Temperature Cycle (°C):	-30 to +85 for 5 cycles ΔR < ±1%
Load Life:	70°C on-off cycle 1000 hours ΔR < ±5%
Moisture-Proof Load Life:	40°C 95% RH on-off cycle 1000 hours ΔR < ±5%
Solder Pot:	270°C for 3 seconds ΔR < ±1%
Incombustibility:	16 times of rated power for 5 minutes - Not Flamed
Maximum Working Voltage:	1000 V

Fusing Characteristics

Fusing times can be decided by consultation with our design team to meet application requirements.

Derating Curve

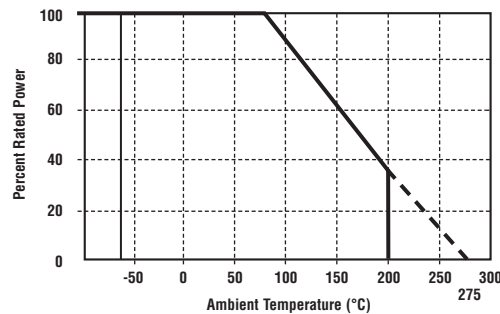

For resistors operated in ambient temperatures above 70°C, power rating must be derated in accordance with this curve.

Dimensions

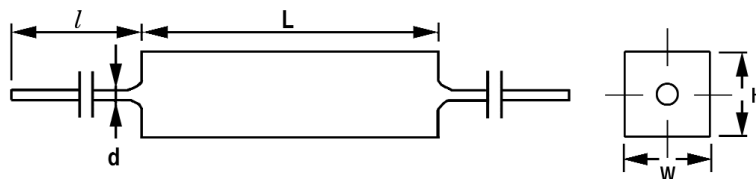

Rated Power	Dimensions					Resistance Range (Ohms)
	L±1.5	H±0.5	W±1.0	C±3.0	d±0.05	
2W	18.0	7.0	7.0	35.0	0.65	R10-22
3W	22.0	8.0	8.0	35.0	0.8	R10-50
5W	22.0	9.0	10.0	35.0	0.8	R20-50
7W	35.0	9.0	10.0	35.0	0.8	R30-100
10W	48.0	9.0	10.0	35.0	0.8	R30-150

How to Order

FSQ	3W	R10	J	T
Common Part	Power Rating	Resistance Value	Tolerance	Packaging
FSQ - Ceramic Housed	Example: 3W 7W	0.1 Ohm (100 milliohms) R10 1.0 Ohm (1000 milliohms) 1R0 50 Ohms (50000 milliohms) 50R	J - ±5%	T - Ammo Boxed

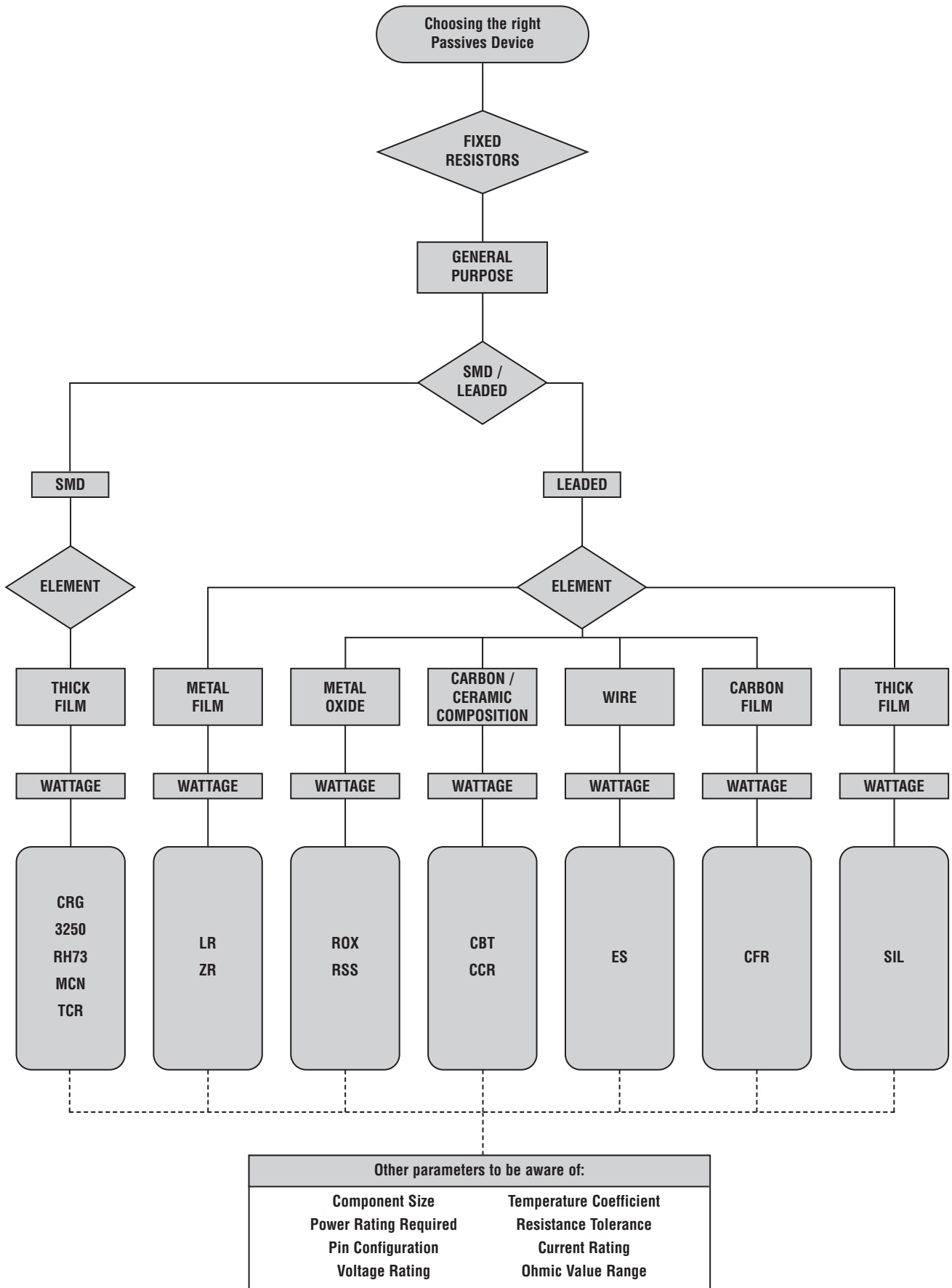

General Purpose Resistors

Product Overview

These resistors from the Neohm, CGS and Citec brands have a wide range of applications and technologies. General purpose resistors are used in many electrical and electronic applications.

The resistors encompass many different technologies including Thick Film, Metal (Thin) Film, Wirewound, Carbon Film and Metal Oxide.

Ranging from small 0402 size surface mount resistors to larger size axial leaded wirewound resistors, power ratings from 0.063W to 10W are available.

The product range also covers specialist applications such as trimmable resistors, zero ohm links and carbon moulded resistors.

- Surface mount products down to 0402 size
- CCR and CBT series for high pulse applications
- High Ohmic resistors to 100G ohm
- Leaded and SMD resistor networks
- SMD Trimmable resistors
- Zero ohm links in 2 sizes

Max Power Rating Watts	Ohmic Value Range	Lowest TCR	Tightest Tolerance	Family	Page
1W	1R0 - 10M	100ppm	1%	CRG	130-131
1W	1R0 - 1M0	200ppm	5%	3520	132
0.6W	10M - 100G	50ppm	2%	RH73	133
0.063W	10R - 1M0	50ppm	1%	MCN	134
0.125W	1R0 - 4M7	200ppm	15%	TCR	135
0.75W	1R0 - 10M	50ppm	1%	LR	136-139
2W	1R0 - 10M	200ppm	2%	CFR	140-141
5W	1R0 - 100K	200ppm	5%	RSSF	142-143
5W	R10 - 560K	300ppm	2%	ROX	144-145
7W	10R - 200K	300ppm	5%	RSS	146
10W	R05 - 3K3	300ppm	2%	ES	147
0.25W	Zero Ohm	n/a	0.002Ω max	ZR	148
0.5W	2R2 - 22M	-600 to +400ppm	5%	CBT	149
2W	3R3 - 390K	-900 to +300ppm	10%	CCR	150-151
0.2W	10R - 1M0	200ppm	2%	SIL	152-153

Type CRG Series

Type CRG Series

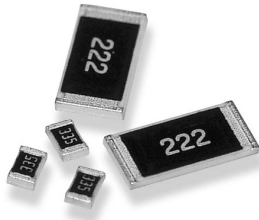

Precious metal terminations are screen printed onto a ceramic base and fired. The resistive element is screen printed and fired and the passivation layer added. Each resistor is trimmed to tolerance by laser. The pre-scribed tile is broken into strips, the end plating is fired on and the strips broken into individual components. Final termination is made by electroplating.

Key Features

- Thick film resistors with a high power to size ratio, ideally suited to industrial and general purpose use. A range from 1 ohm to 10M and tolerances of 1% and 5%. Also including zero ohm links.
- Suitable for most applications, including high frequency operation, owing to the short lead structure and low capacitance.
- Six Package Sizes

Characteristics - Electrical

	0402			0603				0805			
Rated Power @ 70°C (W):	0.063			0.1				0.125			
Resistance Range (Ohms) Min:	10	1	11	10	101	1	11	10	101	1	11
Max:	1M0	10	3M3	100	1M0	10	10M	100	1M0	10	10M
Tolerance (%):	1	5	5	1	1	5	5	1	1	5	5
Code Letter:	F	J	J	F	F	J	J	F	F	J	J
Selection Series:	E24	E24	E24	E24	E24 E96	E24	E24	E24	E24 E96	E24	E24
Temperature Coefficient (ppm/°C):	±100	±400	±200	±200	±100	±400	±200	±200	±100	±400	±200

	1206				2010				2512			
Rated Power @ 70°C (W):	0.25				0.5				1			
Resistance Range (Ohms) Min:	10	101	1	11	10	101	1	11	10	101	1	11
Max:	100	1M0	10	10M	100	1M0	10	10M	100	1M0	10	10M
Tolerance (%):	1	1	5	5	1	1	5	5	1	1	5	5
Code Letter:	F	F	J	J	F	F	J	J	F	F	J	J
Selection Series:	E24	E24 E96	E24	E24	E24	E24 E96	E24	E24	E24	E24 E96	E24	E24
Temperature Coefficient (ppm/°C):	±200	±100	±400	±200	±200	±100	±400	±200	±200	±100	±400	±200

	0402	0603	0805	1206	2010	2512
Working Voltage (V):	50	50	150	200	200	200
Maximum Overload Voltage (V):	50	100	300	400	400	400
Operating Temperature Range (°C):	-55 to +125					
Climatic Category (°C):	55/125/56					
Insulation Resistance Dry Min: (Mohms)	1000					
Stability (%):	3					
Surface Temp. Rise (°C/W) Max:	480	300	280	190	100	65
Zerohm (A) Current Max:	1	1	2	2	2	2
Resistance Max:	<20 mohm					

Dimensions

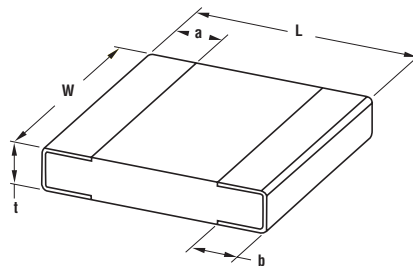

Style	L	W	t	a	b
0402	1.0 ±0.1	0.5 ±0.05	0.35 ±0.05	0.2 ±0.1	0.25 ±0.1
0603	1.6 ±0.1	0.8 ±0.15	0.45 ±0.1	0.3 ±0.2	0.3 ±0.1
0805	2.0 ±0.15	1.25 ±0.15	0.55 ±0.1	0.4 ±0.2	0.4 ±0.2
1206	3.1 ±0.15	1.55 ±0.15	0.55 ±0.1	0.45 ±0.2	0.45 ±0.2
2010	5.0 ±0.1	2.5 ±0.15	0.55 ±0.1	0.6 ±0.25	0.5 ±0.2
2512	6.35 ±0.1	3.2 ±0.15	0.55 ±0.1	0.6 ±0.25	0.5 ±0.2

Type CRG Series (continued)

Derating Curve

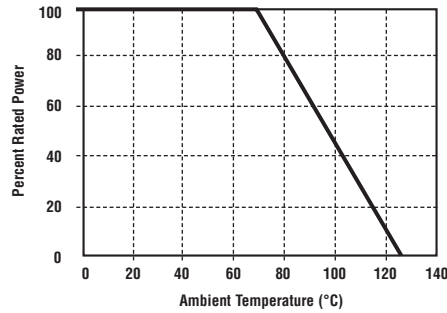

Mounting

The resistors are suitable for processing on automatic insertion equipment.

Marking

CRG0805, CRG1206, CRG2010, CRG2512

E24 series resistors are marked with a three digit code.
E96 series resistors are marked with a four digit code.
Zerohm components are marked '0'.

CRG0603

E24 5% series are marked with a three digit code.
E24 1% series are marked with a three digit code.
E96 series are marked with the international alphanumeric three character code (available on request).
EXCEPT 10, 11, 13, 15, 20 & 75 decades which are marked as the E24 series.

CRG0402 series unmarked.

Performance Characteristics

The evaluation of the performance characteristics is carried out with reference to IECQ specifications QC 400 000 and QC 400 100.

TEST REF	Long Term Tests $\pm(3\% + 0.1 \text{ ohm})$
4.23	Climatic sequence
4.24	Damp heat, steady state
4.25.1	Endurance at 70 °C
4.25.3	Endurance at 125 °C
TEST REF	Short Term Tests $\pm(1\% + 0.05 \text{ ohm})$
4.13	Overload
4.32	Adhesion
4.33	Bond strength of end face plating
4.19	Rapid change of temperature
4.18	Resistance to soldering heat

Storage

Unopened reels should be stored within a temperature range of +5 °C to +25 °C, separated from any dust, chemicals and solvent based materials. Non-adherence to this procedure could effect the solderability of this product.

How to Order

CRG	0603	J	1K0
Common Part	Size	Tolerance	Resistance Value
CRG - Thick Film Precision Chip Resistor	0402 0603 0805 1206 2512	F - $\pm 1\%$ J - $\pm 5\%$	1 ohm (1 ohm) 1R0 1K ohm (1000 ohms) 1K 100K ohm (100000 ohms) 100K 1M ohm (1000000 ohms) 1M

SMD Power Resistors

Type 3520 Series

Type 3520 Series



Tyco Electronics Components is pleased to introduce this low cost high power device, suitable for auto placement in volume, and for most applications, including high frequency operations, owing to the short lead structure. It is attractively priced and available on 7" reels of 4000 pieces.

Key Features

- 1 Watt at 70°C
- Small Size to Power Ratio
- Supplied on Tape
- Available via Distribution
- Value Marked on Resistor
- 400 Volt Maximum Overload
- 200 Volt Working Voltage
- Laboratory Kit Available
- Low Profile

Characteristics - Electrical

Power Rating:	1 Watt at 70°C**
Max. RCWV*:	200V
Max. Overload Voltage:	400V
Resistance Tolerance(%):	±5%
Resistance Range:	1R0 - 1M0
Temperature Coefficient:	±200ppm ±350ppm** (below 10R)
Resistance Grid Value:	E-24

* Rated continuous working voltage (RCWV) shall be determined from

$$RCWV = \sqrt{\text{Rated Power} \times \text{Resistance Value}}, \text{ or Maximum RCWV listed above, whichever is less}$$

** Recommended Circuit Board Design - If this device is anticipated to run at full continuous power then action to improve the cooling should be taken. This can be a metal substrate, copper pad left under the chip, an opening in the PCB or enlarged silver conductor pads each end.

Power Derating Curve

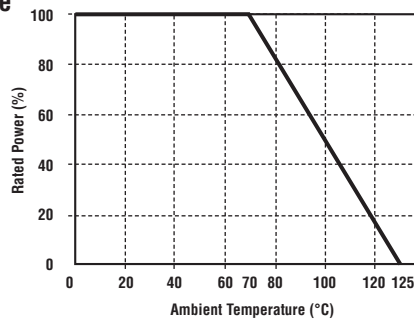

For resistors operated in ambient temperatures above 70°C, power rating must be derated in accordance with this curve.

Dimensions

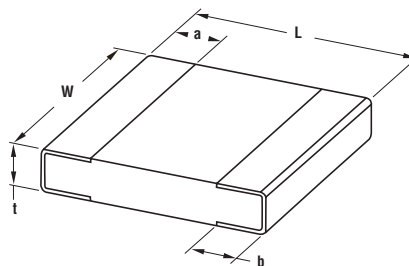

L	W	a	b	t
6.40	3.20	0.70	0.70	0.60
±0.20	±0.20	±0.10	±0.20	±0.10

Handling Recommendations

When flow soldering - the land width must be smaller than the Chip Resistor width to properly control the solder application. Generally, the land width can be Chip Resistor width (W) x 0.7 to 0.8. When reflow soldering - solder application amount can be adjusted. Thus the land width can be set to W x 1.0 to 1.3.

How to Order

3520	1K0	J	T
Common Part	Resistance Value	Tolerance	Pack Style
3520	1 ohm 1000 milli ohms 1R0 1K ohm 1000 ohms 1K0 1 Meg ohm 1000000 ohms 1M0	J - 5%	T - 4000 / reel

SMD High Value Resistors

Type RH73 Series

Type RH73 Series

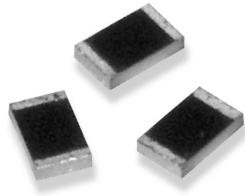

The RH73 Series is a stable high value chip resistor range offering various power dissipation relating to chip size. Tyco Electronics Components is pleased to offer this innovative range of chip resistors up to 100 Gig. The RH73 series is suitable for flow and reflow soldering. It has a thick film resistor element and three layers of terminal material to ensure high reliability. It is attractively priced and available on 7" reels with 1000 pieces per reel.

Key Features

- Values up to 100 Gig Ohms
- Custom Designs Possible
- Choice of Packages
- Supplied on Reels of 1000
- Wide Tolerances / TCRs
- Available via Distribution
- Power derates to zero at 125°C

Characteristics - Electrical

Type	Power Rating @ 70°C	T.C.R's Available per Resistance Value (ppm/°C)				
		10M - 100M	100M1 - 1G0	1G1 - 10G	10G1 - 33G	33G1 - 100G
RH73 1E	0.050 W	100/250	500/1000	1000/2000	-	-
RH73 1J	0.075 W	100/250	250/500	500/1000	1000/2000	-
RH73 2A	0.125 W	50/100	250/500	500/1000	1000/2000	2000/3000
RH73 2B	0.250 W	50/100	250/500	500/1000	1000/2000	2000/3000
RH73 2E	0.350 W	50/100	100/250	250/500	250/500	500/1000
RH73 3A	0.600 W	50/100	100/250	250/500	250/500	500/1000

Type	Max. Working Voltage	Tolerances Available per Resistance Value (%)				
		10M - 100M	100M1 - 1G0	1G1 - 10G	10G1 - 33G	33G1 - 100G
RH73 1E	30V	5/10/20	5/10/20	10/20/30	-	-
RH73 1J	75V	5/10/20	5/10/20	10/20/30	10/20/30	-
RH73 2A	100V	2/5/10/20	5/10/20	5/10/20	10/20/30	10/20/30
RH73 2B	200V	2/5/10/20	5/10/20	5/10/20	5/10/20	10/20/30
RH73 2E	300V	2/5/10/20	5/10/20	5/10/20	5/10/20	5/10/20
RH73 3A	1000V	2/5/10/20	5/10/20	5/10/20	5/10/20	5/10/20

Long Term Stability	<100M	<1G0	1G - 100G
Storage 125°C/1000Hrs:	ΔR <0.15%	ΔR <0.35%	ΔR <0.35%
Maximum Voltage/1000Hrs:	ΔR <0.35%	ΔR <0.50%	ΔR <0.50%

Temperature Range:	-55°C to +125°C
Climatic Category:	55/125/56
Solderability:	235°C for 5 Seconds
Maximum Soldering Temp.:	260°C for 5 Seconds

Dimensions

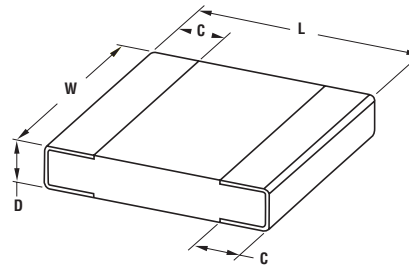

Part Number	L	W	C	D
RH73 1E	1.04±0.05	0.50±0.05	0.10±0.05	0.30±0.05
RH73 1J	1.50 ^{+0.15} _{-0.05}	0.80 ^{+0.15} _{-0.05}	0.20 ^{+0.10} _{-0.05}	0.40 ^{+0.10} _{-0.05}
RH73 2A	2.00 ^{+0.15} _{-0.05}	1.20 ^{+0.20} _{-0.05}	0.30 ^{+0.20} _{-0.05}	0.40 ^{+0.10} _{-0.05}
RH73 2B	3.20 ^{+0.15} _{-0.05}	1.50 ^{+0.20} _{-0.05}	0.30 ^{+0.20} _{-0.05}	0.40 ^{+0.10} _{-0.05}
RH73 2E	3.20 ^{+0.15} _{-0.05}	2.50 ^{+0.20} _{-0.05}	0.80 ±0.20	0.50 ^{+0.10} _{-0.05}
RH73 3A	6.30 ^{+0.15} _{-0.05}	3.50 ^{+0.20} _{-0.05}	0.80 ±0.20	0.60 ^{+0.10} _{-0.05}

How to Order

Common Part	Temp. Coefficient	Package Size	Resistor Value	Tolerance	Packaging
RH73 - Standard Part	G - 50ppm/°C	1E - 04:02	1 Meg Ohm (1000000 ohms)	G - 2%	TN - 1000 Reel (Plastic)
	H - 100ppm/°C	1J - 06:03	1M0	J - 5%	
	U - 250ppm/°C	*2A - 08:05	10 Meg Ohm (10000000 ohms)	K - 10%	
	W - 500ppm/°C	2B - 12:06	10M	M - 20%	
	X - 1000ppm/°C	2E - 12:10	100 Meg Ohm (100000000 ohms)	N - 30%	
	Y - 2000ppm/°C	3A - 25:12	100M		
	Z - 3000ppm/°C	* - Standard Part	1 Gig Ohm (1000000000 ohms)		
			1G0		

If no requirements for TCR, VCR and Voltage are given, the standard values (higher values in table) will be supplied. 10V is used for measuring.

Type MCN Series

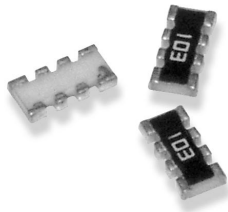

The MCN innovative chip resistor network combines a series of inline isolated 0603 resistors into one package. Obvious savings in board space and number of placements are possible by specifying our 4 or 8 resistor packages. The package layer design prevents tombstoning when reflow soldering the chips. Supplied on 8mm tape. The 8 resistor pack is suitable only to large volume applications and utilises thin film technology to achieve the space network density.

Key Features

- Concave and Convex Terminal Style
- Improved Placement Efficiency
- Superior Solderability
- Nickel Barrier Layer
- Up to 8 Isolated Resistors (Thin Film)
- Individually Value Marked

Type MCN Series

Characteristics - Electrical

Number of Elements:	4 or 8 (x 06.03 size)
Power Rating:	0.063W per resistor (x 06.03 size)
Resistance Range:	10R - 1Meg ohm (E12 values) (8 resistors 10R - 100R Thin Film)
Resistance Tolerance:	±1% ±2% ±5% * Stock is ±5%
Temperature Coefficient of Resistance:	± 250ppm/°C (Down to ± 50ppm/°C possible)
Max. Working Voltage:	50 volts (8 resistors 25 volts)
Operating Temperature Range:	-55°C to +125°C
Maximum Rated Temperature:	+ 70°C

Tape and Reel Pack

Samples Available Loose	4 Resistors 5000 on reel 8 Resistors 5000 on reel
--------------------------------	--

Dimensions - Type MCNT

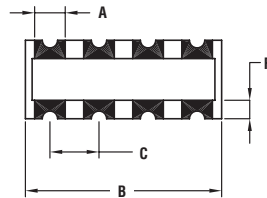

Type MCNY

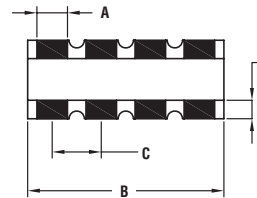

Type MCNC

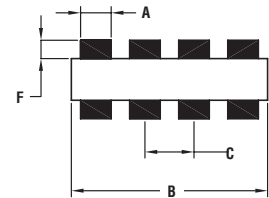

Schematic

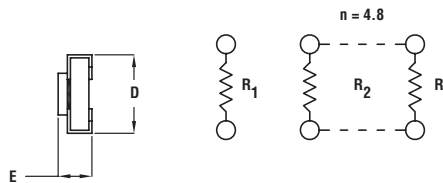

Model	No. of Elements	Dimensions					
		A	B	C	D	E	F
MCNT4	4	0.5±0.15	3.2±0.2	0.8	1.6±0.20	0.6±0.1	0.3±0.15
MCNY4	4	0.5±0.15	3.2±0.2	0.8	1.6±0.20	0.5±0.1	0.3±0.15
MCNC4	4	0.5±0.10	3.2±0.3	0.8	1.6±0.20	0.4±0.1	0.3±0.20
MCNC8	8	0.3±0.10	4.0±0.2	0.5	1.6±0.15	0.4±0.1	0.3±0.20

How to Order

MCNT4	16	103	F
Common Part	Element Type	Resistance Value	Tolerance
MCNT4 - 4 Resistors Concave MCNY4 - 4 Resistors Convex MCNY8 - 8 Resistors Convex MCNC4 - 4 Resistors MCNC8 - 8 Resistors	16:8 Resistor 8:4 Resistor	The first two digits are significant figures of resistance value. The third denotes the number of zeros following. e.g. 1K: 102 50K - 503 100K - 104	F ±1% J ±5%* * Standard

N.B. Take care when using these resistors close to the specified power ratings at the heat generated by a network is greater than that of equivalent individual chip resistors separately placed.

Type TCR Series

Type TCR Series

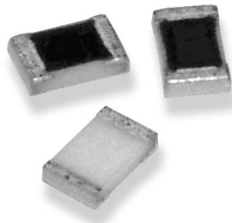

Precious metal terminations are screen printed onto a ceramic base and fired. The resistive element is screen printed and fired and the passivation layer added. The pre-scribed tile is broken into strips, the end plating is fired on and the strips broken into individual components. Final termination is made by electroplating.

Key Features

- TCR chip resistors are suitable for most applications, including high frequency operation, owing to the short lead structure and low capacitance.
- The TCR series of chip resistors is designed to be used in circuits where variable resistors might otherwise be used.
- The resistance film and the coating have been specified to permit YAG laser trimming.
- Case sizes 0805 and 1206.

Characteristics - Electrical

	0805		1206	
Rated Power @ 70°C (W):	0.1		0.125	
Resistance Range (Ohms)	Min: 1	10	1	10
	Max: 9.1	4M7	9.1	4M7
Selection Series:	E24			
Tolerance (%):	±15 or 0/-30			
Code Letter:	L P			
Temperature Coefficient (ppm/°C):	-200/+500	± 200	-200/+500	± 200
Operating Temperature Range (°C):	-55 to +125			
Climatic Category:	55/125/56			
Limiting Element Voltage (V):	150		200	
Insulation Resistance Dry Min (M ohms):	1000			

Dimensions

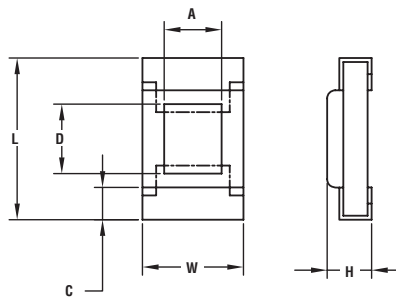

Style	L	W	H	A	D	C	d
0805	2.0 ± 0.1	1.25 ± 0.10	0.55 ± 0.1	0.71 ± 0.1	0.66 ± 0.1	0.4 ± 0.2	0.4 ± 0.2
1206	3.2 ± 0.15	1.6 ± 0.15	0.55 ± 0.1	0.95 ± 0.1	1.30 ± 0.1	0.5 ± 0.25	0.5 ± 0.25

Power Derating Curve

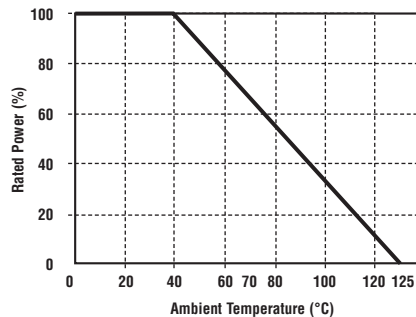

Marking

TCR series resistors are not marked.

How to Order

TCR	0805	L	1K
Common Part	Size	Tolerance	Resistance Value
TCR - Trimmable Chip Resistor	0805 1206	L - 15% P - 0/-30%	1 ohm (1 ohm) 1R0 1K ohm (1000 ohms) 1K 100K ohm (100000 ohms) 100K 1M ohm (1000000 ohms) 1M

Type LR Series

Type LR Series



The resistive element comprises a thin film of nickel-chrome alloy evaporated onto a high thermal conductivity ceramic element. Metal end caps are force fitted to the element prior to spiralling to value. Tinned copper lead wires are welded to the end caps and the components are then coated. One coat of phenolic resin is followed by three coats of epoxy resin. All resistors are tested for value and tolerance.

Key Features

- Superior quality metal film resistors with 1% tolerance and temperature coefficients down to 50 ppm. 3 case sizes are available in 0.25, 0.6, 0.75W. The LR1L series is a low ohmic value range from 0.1 to 0.82 ohm. Ideally suited where low resistance and small size are required.
- Metal film resistors have excellent stability under load and severe environmental conditions. They exhibit very low noise current and voltage coefficients. They are available in a wide range of resistance values and are suitable for general purpose and precision applications.

Characteristics - Electrical

	LR0204		LR1L	LR1			LR2	LR100	LR200	
Rated Power @ 70°C (W)	0.25		0.5	0.6			0.75	1	2	
Resistance Range (Ohms)	Min	1R0	10R	R10	1R0	10R	1M1	1R0	10R	10R
	Max	9R1	1M0	R82	9R1	1M0	10M	1M0	1M0	1M0
Tolerance (%)	1	1	5	1 2	1 2	1 5	1 2	1 5	1 5	
Code Letter	F	F	J	F G	F G	F J	F G	F J	F J	
Temperature Coefficient (ppm/°C)	± 100	± 100	± 200	± 100	± 50	± 100	± 100	25/50/100	25/50/100	
Selection Series	E24	E24	E12	E24	E24	E24	E24	E24	E24	
On Request		E96			E96		E96	E96	E96	
Limiting Element Voltage	200		350	350			350	500	500	
Max Permitted Element Voltage	200		350	350			350	500	500	
Max Overload Voltage	400		500	700			700	1000	1000	
Max Intermittent Overload Voltage	500		750	750			750	1000	1000	
Operating Temperature Range (°C)	-55 to +155									
Climatic Category	55/155/56									
Dielectric Strength (V)	500	700	700	700	700	700	700	700	700	
Insulation Resistance Min Dry (Mohms)	1000									

Dimensions

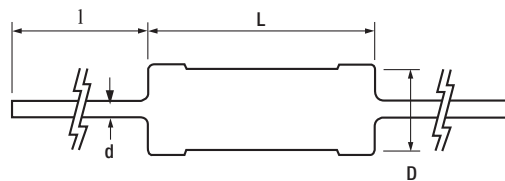

Style	L*	D	d Nom	l
LR0204	3.2 ± 0.2	1.7 ± 0.2	0.45	25
LR1L	6.2 ± 0.5	2.3 ± 0.2	0.55	25
LR1	6.2 ± 0.5	2.3 ± 0.2	0.55	25
LR2	9.7 ± 0.3	3.5 ± 0.2	0.7	25
LR100	12.0 ± 1.0	5.5 ± 0.5	0.8	25
LR200	16.0 ± 1.0	6.5 ± 0.5	0.8	29

* Length is measured in accordance with IEC 294.

Power Derating Curve

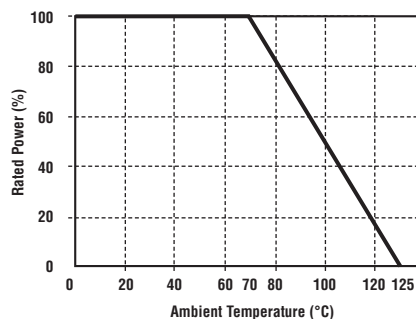

Surface Temperature Rise Vs Load

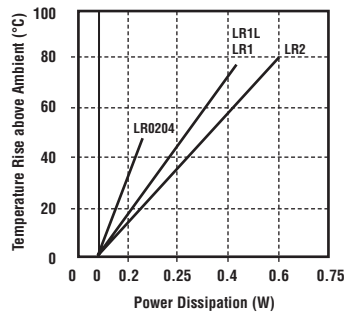

Mounting

The resistors are suitable for processing on automatic insertion equipment and cutting and bending machines.

Marking

The resistors are marked with a colour band code in accordance with JIS C 0802.

Packaging

LR0204, LR1L and LR1 resistors are normally supplied taped in 'ammo' boxes of 4000 pieces. LR2 resistors are normally supplied taped in 'ammo' boxes of 1000 pieces.

Other package styles on request.

All tape specifications are in accordance with IEC 286-1.

Performance Characteristics

The evaluation of the performance characteristics is carried out with reference to IEC Specifications QC 400 000 and QC 400 100.

TEST REF	Long Term Tests $\pm(1\% + 0.05 \text{ ohm})$
4.23	Climatic sequence
4.24	Damp heat, steady state
4.25.1	Endurance at 70°C
4.25.3	Endurance at 125°C
TEST REF	Short Term Tests $\pm(0.25\% + 0.05 \text{ ohm})$
4.13	Overload
4.16	Robustness of terminations
4.18	Resistance to soldering heat
4.19	Rapid change of temperature
4.22	Vibration

* For LR1L the limits are $\pm(5\% + 0.1 \text{ ohm})$ and $\pm(1\% + 0.05 \text{ ohm})$ respectively. All resistance values are measured at a distance of 12mm from the end cap.

How to Order

LR	1	F	100R
Common Part	Style	Tolerance	Value
LR - Metal Film Fixed Resistor	0204 - 0.25W 1L - 0.5W 1 - 0.6W 2 - 0.75W 100 - 1W 200 - 2W	J - 5% G - 2% F - 1%	100 ohm (100 ohms) 100R 1K0 (1000 ohms) 1K0 100 K ohm (100,000 ohms) 100K

Type LR Series Laboratory Kit

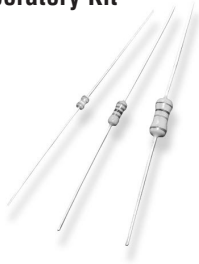

The resistive element comprises a thin film of nickel-chrome alloy evaporated onto a high thermal conductivity ceramic element. Metal end caps are force fitted to the element prior to spiralling to value. Tinned copper lead wires are welded to the end caps and the components are then coated. One coat of phenolic resin is followed by three coats of epoxy resin. All resistors are tested for value and tolerance.

Key Features

- Superior quality metal film resistors with 1% tolerance and temperature coefficients down to 50 ppm. 3 case sizes are available in 0.25, 0.6, 0.75W. The LR1L series is a low ohmic value range from 0.1 to 0.82 ohm. Ideally suited where low resistance and small size are required.
- Metal film resistors have excellent stability under load and severe environmental conditions. They exhibit very low noise current and voltage coefficients. They are available in a wide range of resistance values and are suitable for general purpose and precision applications.
- For full Technical Specification, refer to LR Series Datasheet (Literature No. 1773241)

Type LR Series Laboratory Kit

Laboratory Kit Contents - LR0204

Value	Value	Value	Value	Value
*0R0				
10R	100R	1K0	10K	100K
11R	110R	1K1	11K	110K
12R	120R	1K2	12K	120K
13R	130R	1K3	13K	130K
15R	150R	1K5	15K	150K
16R	160R	1K6	16K	160K
18R	180R	1K8	18K	180K
20R	200R	2K0	20K	200K
22R	220R	2K2	22K	220K
24R	240R	2K4	24K	240K
27R	270R	2K7	27K	270K
30R	300R	3K0	30K	300K
33R	330R	3K3	33K	330K
36R	360R	3K6	36K	360K
39R	390R	3K9	39K	390K
43R	430R	4K3	43K	430K
47R	470R	4K7	47K	470K
51R	510R	5K1	51K	510K
56R	560R	5K6	56K	560K
62R	620R	6K2	62K	620K
68R	680R	6K8	68K	680K
75R	750R	7K5	75K	750K
82R	820R	8K2	82K	820K
91R	910R	9K1	91K	910K
				1M0

* Zerohm value (0R0) is supplied as ZR0204
Each Kit contains 20 pieces of each value listed above

Laboratory Kit Contents - LR1L

Value	Value	Value	Value
R10	R22	R47	R68
R15	R33	R56	

LR1

Value	Value	Value	Value	Value	Value
*0R0					
1R0	10R	100R	1K0	10K	100K
1R1	11R	110R	1K1	11K	110K
1R2	12R	120R	1K2	12K	120K
1R3	13R	130R	1K3	13K	130K
1R5	15R	150R	1K5	15K	150K
1R6	16R	160R	1K6	16K	160K
1R8	18R	180R	1K8	18K	180K
2R0	20R	200R	2K0	20K	200K
2R2	22R	220R	2K2	22K	220K
2R4	24R	240R	2K4	24K	240K
2R7	27R	270R	2K7	27K	270K
3R0	30R	300R	3K0	30K	300K
3R3	33R	330R	3K3	33K	330K
3R6	36R	360R	3K6	36K	360K
3R9	39R	390R	3K9	39K	390K
4R3	43R	430R	4K3	43K	430K
4R7	47R	470R	4K7	47K	470K
5R1	51R	510R	5K1	51K	510K
5R6	56R	560R	5K6	56K	560K
6R2	62R	620R	6K2	62K	620K
6R8	68R	680R	6K8	68K	680K
7R5	75R	750R	7K5	75K	750K
8R2	82R	820R	8K2	82K	820K
9R1	91R	910R	9K1	91K	910K
					1M0

* Zerohm value (0R0) is supplied as ZR0207
Each Kit contains 20 pieces of each value listed above

Type LR Series Laboratory Kit (continued)

Laboratory Kit Contents (continued) - LR2

Value	Value	Value	Value	Value
*0R0				
10R	100R	1K0	10K	100K
11R	110R	1K1	11K	110K
12R	120R	1K2	12K	120K
13R	130R	1K3	13K	130K
15R	150R	1K5	15K	150K
16R	160R	1K6	16K	160K
18R	180R	1K8	18K	180K
20R	200R	2K0	20K	200K
22R	220R	2K2	22K	220K
24R	240R	2K4	24K	240K
27R	270R	2K7	27K	270K
30R	300R	3K0	30K	300K
33R	330R	3K3	33K	330K
36R	360R	3K6	36K	360K
39R	390R	3K9	39K	390K
43R	430R	4K3	43K	430K
47R	470R	4K7	47K	470K
51R	510R	5K1	51K	510K
56R	560R	5K6	56K	560K
62R	620R	6K2	62K	620K
68R	680R	6K8	68K	680K
75R	750R	7K5	75K	750K
82R	820R	8K2	82K	820K
91R	910R	9K1	91K	910K
				1M0

* Zerohm value (0R0) is supplied as ZR0207
Each Kit contains 20 pieces of each value listed above

Dimensions

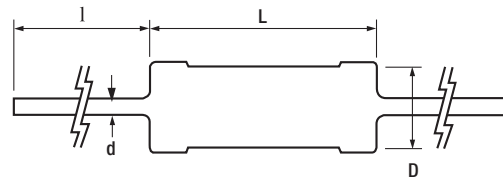

Style	L*	D	d Nom	l
LR0204	3.2 ± 0.2	1.7 ± 0.2	0.45	25
LR1L	6.2 ± 0.5	2.3 ± 0.2	0.55	25
LR1	6.2 ± 0.5	2.3 ± 0.2	0.55	25
LR2	9.7 ± 0.3	3.5 ± 0.2	0.7	25

* Length is measured in accordance with IEC 294.

How to Order

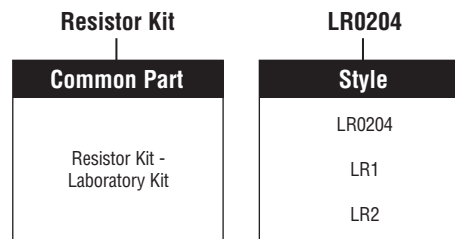

Carbon Film Fixed Resistors

Type CFR Series

Type CFR Series



The resistive element comprises a thin film of carbon, deposited onto a high thermal conductivity ceramic core. Metal end caps are force fitted to the element prior to spiralling to value. Tinned copper lead wires are welded to the end caps and the components are then coated. One coat of phenolic resin is followed by three coats of epoxy resin. All resistors are tested for value and tolerance.

Key Features

- Low cost, combined with high reliability, make these components suitable for use in most types of circuits, including audio, communications, measurement and computer applications.
- Premium quality carbon film resistors whose ceramic core has a high alumina content offering power to size ratios not normally associated with carbon film product.
- Available in 5 power ratings from 1 ohm to 10 Mohm. The smallest case size (CFR16) has a full 0.25 W power rating.

Characteristics - Electrical

	CFR16	CFR25	CFR50	CFR100	CFR200
Rated Power @ 70°C (W):	0.25	0.33	0.5	1	2
Resistance Range (Ohms) Min:	1R0	1R0	1R0	1R0	1R0
Max:	4M7	10M	10M	10M	10M
Tolerance (%):			2	5	
Code Letter:			G	J	
Temperature Coefficient (ppm/°C) R<10:	0 to +200	0 to +200	0 to +200	0 to +350	0 to +350
R>10:	0 to -1200	0 to -1200	0 to -1200	-100 to -500	-100 to -500
Selection Series:	E24				
Limiting Element Voltage (V):	200	250	350	500	500
Max Overload Voltage¹ (V):	400	500	700	1000	1000
Max Intermittent Overload Voltage² (V):	500	700	750	750	750
Operating Temperature Range (°C):	-55 to +155				
Climatic Category (°C):	55/155/56				
Dielectric Strength (V):	400	500	700	1000	1000
Insulation Resistance (Mohms):	1000				

¹Maximum Overload Voltage is 2.5 times rated voltage up to the specified voltage for 5 seconds.

²Maximum Intermittent Overload Voltage is 4 times rated voltage up to the specified voltage for 1 second ON and 25 seconds OFF. >100R ONLY

Dimensions

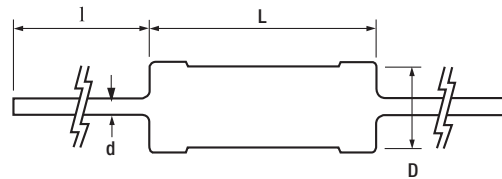

Style	L* max.	D max.	d ±0.05	l
CFR16	3.5	1.85	0.45	28 ± 3
CFR25	6.8	2.5	0.54	28 ± 3
CFR50	9.0	3.0	0.54	28 ± 3
CFR100	12.0	5.0	0.70	28 ± 3
CFR200	16.0	5.5	0.70	28 ± 3

* Length is measured in accordance with IEC 294

Derating Curve

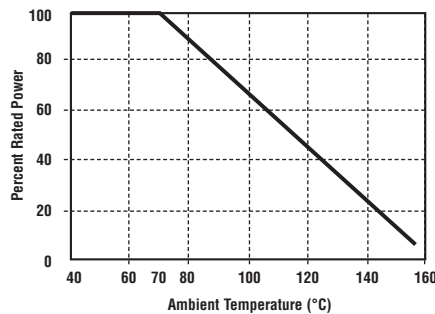

Type CFR Series (continued)

Surface Temperature Rise vs Load

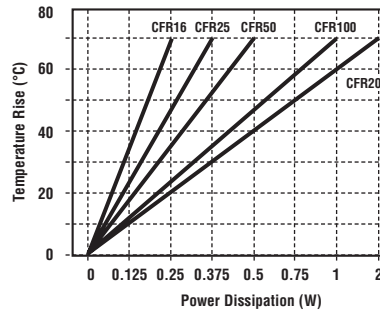

Marking

The resistors are marked with a four colour band code in accordance with IEC 62.

Mounting

The resistors are suitable for processing on automatic insertion equipment and cutting and bending machines.

Packaging

Carbon film resistors are normally supplied taped in 'ammo' boxes. Other styles may be supplied on request. All tape specifications are in accordance with IEC 286-1.

Type	Box Quantity	Std. Tape Spacing	Component Spacing
CFR16	5000	52	5
CFR25	4000	52	5
CFR50	3000	52	5
CFR100	1000	64	10
CFR200	500	64	10

Performance Characteristics

The evaluation of the performance characteristics is carried out with reference to IECQ specifications QC 400 000 and QC 400 100.

TEST REF	Long Term Tests $\pm(5\% + 0.1 \text{ ohm})$
4.23	Climatic sequence
4.24	Damp heat, steady state
4.25.1	Endurance at 70°C
4.25.3	Endurance at 155°C
TEST REF	Short Term Tests $\pm(1\% + 0.05 \text{ ohm})$
4.13	Overload
4.16	Robustness of terminations
4.18	Resistance to soldering heat
4.19	Rapid change of temperature
4.22	Vibration

How to Order

CFR	16	J	100R
Common Part	Size	Tolerance	Value
CFR - Carbon Film Fixed Resistor	16 - 0.25 Watts 25 - 0.33 Watts 50 - 0.5 Watts 100 - 1.0 Watts 200 - 2.0 Watts	G - 2% J - 5%	1 ohm (1 ohm) 1R0 1K ohm (1000 ohms) 1K 100K ohm (100000 ohms) 100K 1M ohm (1000000 ohms) 1M

Type RSSF Series

Type RSSF Series



The resistive element comprises a metal oxide film deposited on a ceramic former. The element is protected by a flameproof coating which will withstand overload conditions without flame or mechanical damage. They are recommended for use in applications such as line protection, automotive, TV's, switch mode power supplies, etc...

Key Features

- High Power with Small Size for Space Saving
- Excellent Long Term Stability
- Complete Flameproof Construction
- High Surge/Overload Capability
- Controlled Temperature Capability
- Solvent Resistant Coat and Code

Characteristics - Electrical

	RSSF 3		RSSF 5	
Rated Power @ 70°C (W):	3		5	
Resistance Range (ohms):	1R0 – 9R1	10R – 100K	1R0 – 9R1	10R – 100K
Tolerance (%):	10	5	10	5
Code Letter:	K	J	K	J
Temperature Coefficient Max (ppm/°C):	± 200			
Selection Series:	E24			
Limiting Element Voltage (V):	500		500	
Maximum Overload Voltage (V):	800		1000	
Max Intermittent Overload Voltage (V):	1000		1500	
Operating Temperature Range (°C):	-55 to +155			
Climatic Category:	55/155/56			
Dielectric Strength (V):	1000			

Dimensions

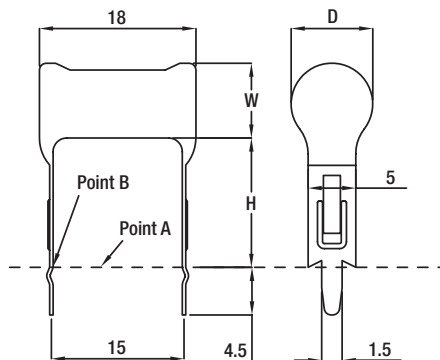

Style	D ±1.5	W ±1.5	H +3.0/-0
RSSF 3	7.5	7.5	15
RSSF 5-15	7.5	7.5	15
RSSF 5-25	7.5	7.5	25

Points A & B define temperature rise measurement points
See graphs on next page

Marking

The resistors are marked alpha numerically with the type, value and tolerance.

Packaging

The RSSF Series resistors are packed loose in box quantities of 500 with an MOQ 1000.

Power Derating Curve

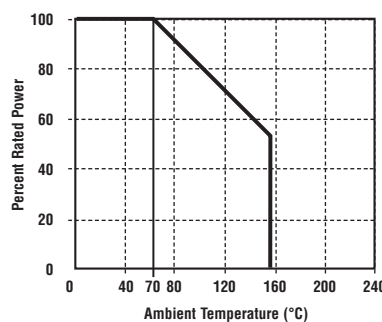

Type RSSF Series (continued)

Pulse Handling Capability
RSSF 5W 1R8 5%

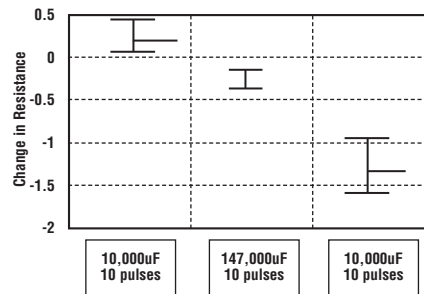

Temperature Rise
RSSF3 1K0

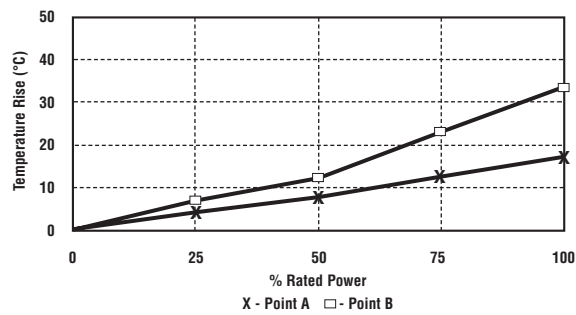

Temperature Rise
RSSF5 1K0

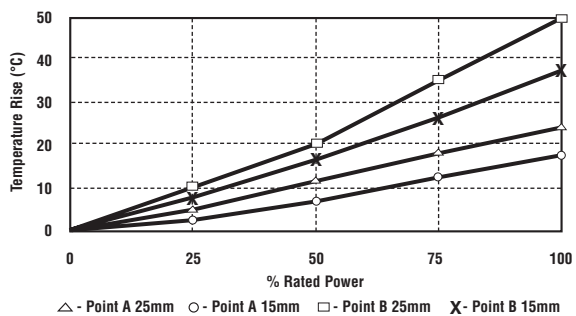

How to Order

RSSF	3	J	100R
Common Part	Power Rating	Tolerance	Resistance Value
RSSF- Flame-Proof Power Metal Oxide Film Resistors	3 - 3 Watts 5 - 5 Watts	J - 5% K - 10%	100 ohm (100 ohms) 100R 1K0 (1000 ohms) 1K0 100K ohm (100,000 ohms) 100K

General Purpose Resistors

Type ROX Series

Type ROX Series

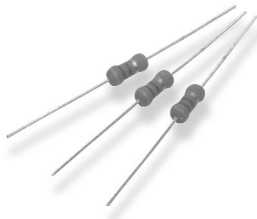

The resistive element comprises a metal oxide film deposited on a ceramic former. The element is protected by a flameproof coating which will withstand overload conditions without flame or mechanical damage. They are recommended for use in applications such as line protection etc...

Characteristics - Electrical

	ROX05	ROX1	ROX2	ROX05S	ROX1SS	ROX1S	ROX2S	ROX3S	ROX5S
Rated Power @ 70°C (W):	0.5	1	2	0.5	1	1	2	3	5
Resistance Range (ohms) Min:	0.1	0.1	0.1	0.1	0.1	0.1	0.1	0.1	0.1
Max:	330K	470K	560K	100K	200R	270K	470K	560K	560K
Tolerance (%):				2		5			
Code Letter:					G		J		
Temperature Coefficient Max (ppm/°C):						± 300			
Selection Series:	E24								
Limiting Element Voltage (V):	250	350	350	250	350	350	350	350	500
Maximum Overload Voltage (V):	400	600	600	400	400	600	600	600	800
Max Intermittent Overload Voltage (V):	500	750	750	500	500	750	750	750	1500
Operating Temperature Range (°C):	-55 to +235								
Climatic Category:	55/235/56								
Dielectric Strength (V):	250	350	350	250	350	350	350	350	500
Insulation Resistance (Mohms):	1,000								

Key Features

- High Power with Small Size for Space Saving
- Excellent Long Term Stability
- Complete Flameproof Construction
- High Surge/Overload Capability
- Controlled Temperature Capability
- Solvent Resistant Coat and Code
- Special Lead Formations Possible

Dimensions

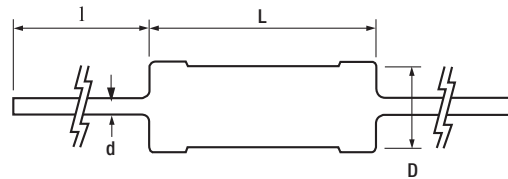

Dimension "l" refers to loose packaged product only

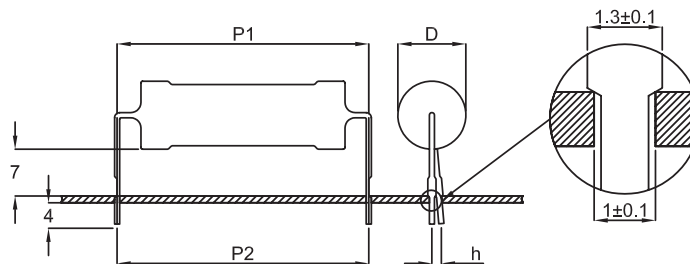

Standard Range Ledged

Style	L ±1	D	d nom	l min
ROX05	9	3 ±0.5	0.7	25
ROX1	11	4 ±0.5	0.7	25
ROX2	16	6 ±1	0.8	35

Standard Range Pre-formed

Style	P1 ±0.5	P2 ±2	H1	H2	h max
ROX05	12.5	12.5	7.5 ±1.5	3.5 ±1	2.0
ROX1	15	15	7.5 ±1.5	3.5 ±1	2.0
ROX2	20	20	7.5 ±2.0	3.5 ±1	3.0

"S" Range Ledged

Style	L ±1	D ±0.5	d nom	l min
ROX05S	6.5	2.3	0.6	25
ROX1SS	6.5	2.3	0.6	25
ROX1S	9	3	0.7	25
ROX2S	11	4	0.8	25
ROX3S	15	5.5	0.8	35
ROX5S	25 ±2	8.5 ±1	0.8	35

"S" Range Pre-formed

Style	P1 ±0.5	P2 ±2	H1	H2	h max
ROX05S	10	10	7.5 ±1.5	3.5 ±1	2.0
ROX1SS	10	10	7.5 ±1.5	3.5 ±1	2.0
ROX1S	12.5	12.5	7.5 ±0.5	3.5 ±1	2.0
ROX2S	15	15	7.5 ±1.5	3.5 ±1	2.9
ROX3S	20	20	7.5 ±2.0	3.5 ±1	3.0
ROX5S	30	30	7.5 ±2.0	3.5 ±1	3.0

Mounting

The resistors are suitable for processing on automatic insertion equipment and cutting and bending machines.

Marking

The resistors are marked with a four-band colour code in accordance with IEC 62.

Type ROX Series (continued)

Power Derating Curve

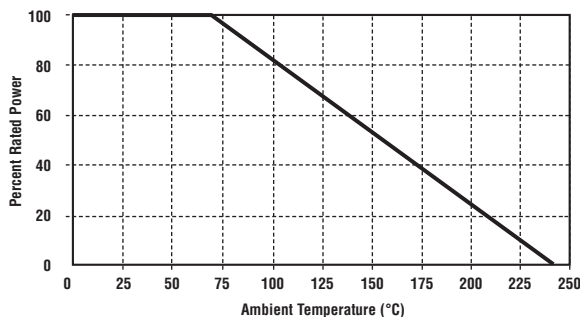

Packaging

New Style Reference	Quantity per Ammo Pack	Std tape Spacing	Component Spacing
ROX05	2,000	52	5
ROX1	1,000	52	5
ROX2	1,000	63	10
ROX05S	2,000	52	5
ROX1SS	2,000	52	5
ROX1S	2,000	52	5
ROX2S	1,000	52	5
ROX3S	1,000	63	10
ROX5S	500	63	10

* Other tape spacings available on request
Other packaging styles are available on request

Performance Characteristics

The evaluation of the performance characteristics is carried out with reference to IEC Specifications QC 400 000 and QC 400 100.

TEST REF	Long Term Tests ± (5% + 0.1 ohm)
4.23	Climatic sequence
4.24	Damp heat, steady state
4.25.1	Endurance at 70°C
4.25.3	Endurance at 235°C
TEST REF	Short Term Tests ± (1% + 0.05 ohm)
4.13	Overload
4.16	Robustness of terminations
4.18	Resistance to soldering heat
4.19	Rapid change of temperature
4.22	Vibration

How to Order



General Purpose Resistors

Type RSS Series

Type RSS Series

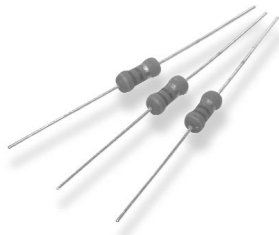

Miniature Power Oxide Resistors offer excellent performance in applications where stability and uniformity of characteristics are required. They provide smaller size for PC board application with high performance and precision to replace some wire-wound resistors and other high power resistors. Miniature metal oxide resistors withstand solvents test in accordance with MIL-STD-202E without producing mechanical or electrical damage.

Key Features

- High Power with Small Size for Space Saving
- Excellent Long Term Stability
- Complete Flameproof Construction
- High Surge/Overload Capability
- Controlled Temperature Capability
- Solvent Resistant Coat and Code
- Special Lead Formations Possible

Characteristics - Electrical

	RSS-1/2W	RSS-1W	RSS-2W	RSS-3W	RSS-5W	RSS-7W
Power Rating at 70°C:	1/2W	1W	2W	3W	5W	7W
Maximum Working Voltage:	250V	350V	350V	350V	500V	750V
Maximum Overload Voltage:	600V	600V	600V	800V	1000V	400V
Resistance Range*:	10R-33K	10R-50K	10R-50K	10R-56K	10R-100K	10R-200K

* Wider Values to Order

Short Time Overload:	2.5 times rated voltage for 5 seconds
Temperature Range:	-55°C to +155°C
Temperature Coefficient:	±300 ppm

Dimensions

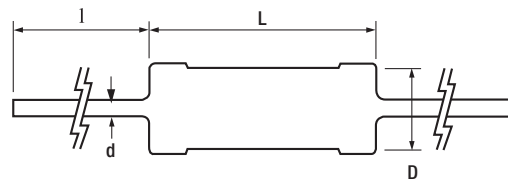

Style	D-mm	L-mm	l-mm	D-mm
RSS-1/2W	2.6±0.5	6.8±1.0	30±3	0.60±0.05
RSS-1W	3.5±0.5	9.0±1.0	30±3	0.65±0.05
RSS-2W	4.5±0.5	11.0±1.0	30±3	0.80±0.05
RSS-3W	5.0±0.5	15.0±1.0	30±3	0.80±0.05
RSS-5W	8.5±0.5	24.0±1.0	38±3	0.80±0.05
RSS-7W	8.5±0.5	41.0±1.0	38±3	0.80±0.05

Power Derating Curve

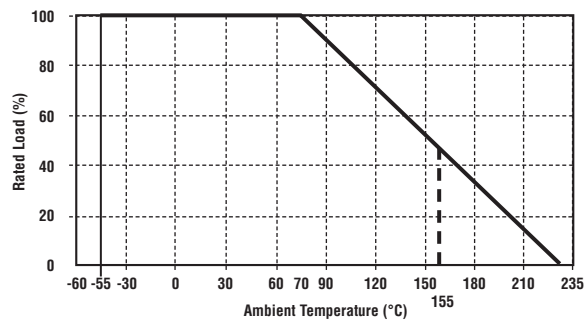

How to Order

RSS	2W	100R	J	TB
Common Part	Wattage at 70°C	Resistance Value	Tolerance	Packaging
RSS - Standard Part	See Above Table	100 ohm (100 ohms) 100R 1K0 ohm (1000 ohms) 1K0 100K ohm (100,000 ohms) 100K	J - 5%	TB - Ammo packed box TR - Tape and Reel

High Power Resistors

Type ES Series

Type ES Series



The ES is a new wirewound resistor from Tyco Electronics Components manufactured to stringent quality control requirements and is an economy sister to the well known Tyco Electronics ER resistor Series. Whilst very slightly larger than the ER resistor and manufactured to a marginally different specification, the ES resistor is suited to volume requirements in power supplies, process control instruments, communication equipment, and other industrial positions. In addition to the ES resistor we offer the practicality of a wirewound resistor down to 9.0mm. x 3.00 mm., body size.

Key Features

- High Power to Size Ratio
- Entirely Welded Construction
- 0.5 Watt to 10 Watt Sizes
- Insulation Resistance >1000M
- Completely Flameproof
- Temperature Coefficient 300 ppm
- All Product Banded

Characteristics - Electrical

Resistance Values:	R10 - 3K3 (Other values by agreement/see wattage table below)
Selection Tolerance:	± 5 % (Other tolerances by agreement)
Rated Dissipation @ 20°C:	See Table Below
Dielectric Strength:	500V AC
Insulation Resistance:	1000 M
Short Term Overload Power:	5 times overload 5 seconds
Terminal Strength:	5lb pull Test
Solderability:	Meets MIL - STD - 202
Maximum Operating Temperature:	200°C
Temperature Coefficient of Resistance:	± 300ppm°C

Dimensions

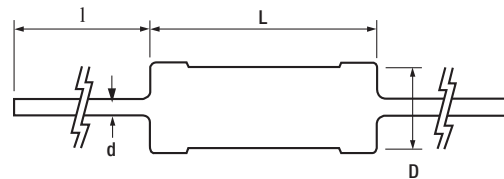

Type ES @ 20°C	Dimensions				Resistance Range	Dielectric Withstand Voltage
	D±1.0	L±1.5	l±3.0	d±0.05		
1/2W	3.0	9.0	30.0	0.65	R05-68R	350V
1W	4.0	9.0	30.0	0.65	R05-100R	500V
2W	5.0	11.0	30.0	0.80	R05-150R	500V
3W	5.5	13.0	38.0	0.80	R05-200R	500V
3WY	6.0	17.0	38.0	0.80	201R-470R	500V
5W	6.5	20.0	38.0	0.80	R10-390R	500V
6W	8.5	25.0	38.0	0.80	R10-1K0	500V
7W	8.5	32.0	38.0	0.80	R10-1K5	500V
8W	8.5	41.0	38.0	0.80	R10-2K2	800V
10W	8.5	53.0	33.0	0.80	R10-3K3	1000V

Resistance Value Marking

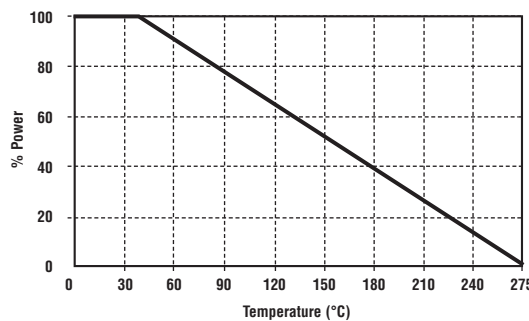

Surface Temperature Vs Power

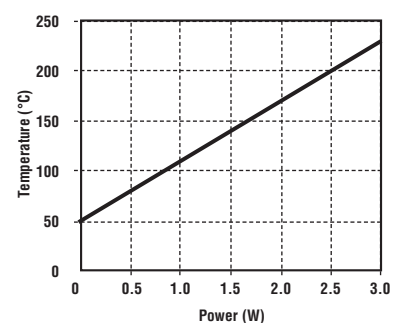

How to Order

ES2W	R10	J
Common Part	Resistance Value	Tolerance
ES05W - 1/2W ES1W - 1W ES2W - 2W ES3W - 3W ES3WY - 3W ES5W - 5W ES6W - 6W ES7W - 7W ES8W - 8W ES10W - 10W	0.1 ohm (100 milliohms) R10 1 ohm (1000 milliohms) 1R0 1K ohm (1000 ohms) 1K0	J - ±5%

Type ZR Series

Type ZR Series



The Tyco Electronics Components Series of Zerohm links are available in two standard case sizes and are manufactured by welding tinned copper wire leads directly onto steel slugs. No end caps are used in the production of these devices. This manufacturing process allows for a maximum resistance of 0.002 ohms. The slugs are then finished by applying three coats of light brown epoxy resin.

Key Features

- Suited to Automatic Insertion
- Withstand to 500 Volts
- Maximum Resistance 0.002 ohm
- Available in Two Case Sizes

Characteristics - Electrical

	ZR0204	ZR0207
Current Carrying Capacity:	Fusing rating of copper wire leads	
Resistance Max:	0.002 Ohms	
Operating Temperature Range:	-55°C to +125°C	
Climatic Category:	55/155/56	
Dielectric Strength:	500 Volts	
Insulation Resistance Minimum Dry:	10G Ohms	

Dimensions

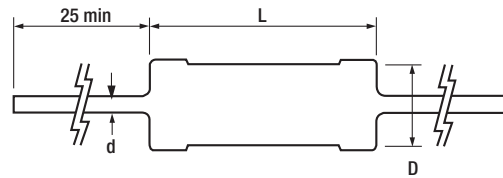

Style	L*	D	d (nom)
ZR0204	3.3 ± 0.4	1.8 ± 0.3	0.45
ZR0207	5.6 ± 0.3	2.3 ± 0.2	0.54

* Length is measured in accordance with IEC 294.

Marking

ZR0204 Zerohm Links are marked with a single narrow black band at the centre of the body.
ZR0207 Zerohm Links are marked with a single wide yellow band at the centre of the body.

Mounting

The resistors are suitable for processing on automatic insertion equipment and cutting and bending machines.

Packaging

ZR0204 Zerohm Links are axially taped and packed in boxes of 5000.
ZR0207 Zerohm Links are axially taped and packed in boxes of 4000.

How to Order

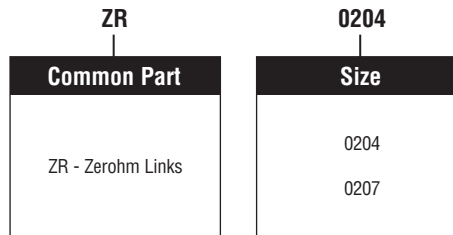

Carbon Composition Resistors

Type CBT Series

Type CBT Series



The CBT series of resistors is constructed utilising solid carbon composition, which is the traditional medium for absorbing high energy pulses, in cases of high inrush current. These resistors have evolved over many years to have excellent pulse withstand capabilities, whilst remaining very stable. These improved characteristics have been achieved by prudent selection of materials of optimum physical properties and by advances in the manufacturing process.

Key Features

- Designed for Pulse Withstand
- Range of Resistance Tolerances
- Solid Carbon Composition
- Low Cost, High Performance
- Two Sizes Available
- Wide Range of Resistance Values
- Supplied Ammo Pack in boxes of 2000

Characteristics - Electrical

	CBT25	CBT50
Power at 70°C Ambient:	0.25 Watts Derating to 0 at +125°C	0.5 Watts Derating to 0 at +125°C
Maximum Voltage:	250 Volts	350 Volts
Resistance Range:	1R0 - 5M6	1R0 - 22M
Resistance Values:	5% E24 Series 10% E12 Series 20% E6 Series	
Voltage Coefficient:	± 0.035%/V	± 0.035%/V
Limiting Element Voltage:	250 Volts	350 Volts
Maximum Overload Voltage:	400 Volts	700 Volts
Insulation Resistance:	1000 M minimum	

Environmental

Operating Temperature Range:	-55°C to +125°C
Temperature Cycles: (-55°C to +125°C, 5 cycles)	ΔR/R ± 2%
Load Life (1000 hours at 70°C):	ΔR/R ± 10%
Resistance to Solder Heat: (350°C for 3 seconds)	ΔR/R ± 3%
Short Time Overload: (2.5 x Rated Power for 5 seconds)	ΔR/R ± 2%
Humidity (40°C, 95%RH, 240 hrs):	ΔR/R ± 3%

Dimensions-

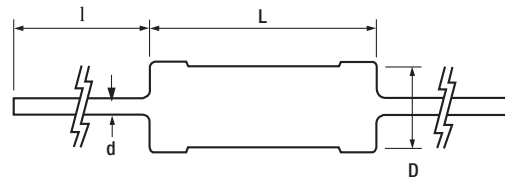

Style	L	D	l	d
CBT25	6.3 ± 0.7	2.4 ± 0.1	27 min.	0.6
CBT50	9.5 ± 0.8	3.6 ± 0.2	25 min.	0.7

Pulse Withstand Characteristics

Charging and Discharging a 2000 pF Capacitor for 100 Cycles

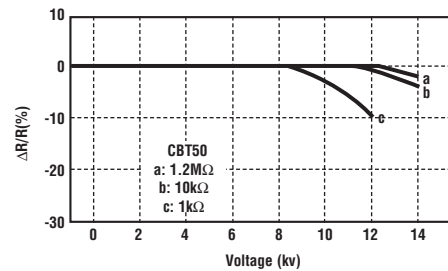
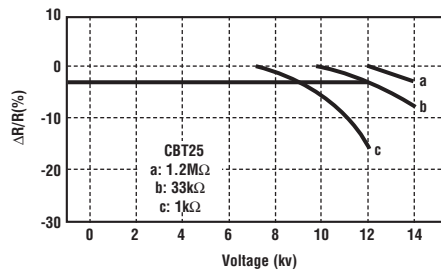

How to Order

CBT	25	J	10K
Common Part	Size	Tolerance	Resistance Value
Carbon Composition Resistor	25 - 0.25W 50 - 0.5W	J - ±5% K - ±10% M - ±20%	1 ohm (1 ohm) 1R0 1K ohm (1000 ohms) 1K 100K ohm (100000 ohms) 100K 1M ohm (1000000 ohms) 1M

Ceramic Composition Resistors

Type CCR Series

Type CCR Series



The CCR series of resistors is constructed utilising solid ceramic composition, which is the traditional medium for absorbing high energy pulses, in cases of high inrush current. These resistors have evolved over many years to have excellent pulse withstand capabilities, whilst remaining very stable. These improved characteristics have been achieved by prudent selection of materials of optimum physical properties and by advances in the manufacturing process. The CCR series are ideal for circuitry associated performance in high voltage power supplies, R-C snubber circuits, and inrush limiters.

Key Features

- Designed for Pulse Withstand
- Range of Resistance Tolerances
- Solid Ceramic Composition
- Low Cost, High Performance
- Two Sizes Available
- Wide Range of Resistance Values
- Available on Tape

Characteristics - Electrical

Power at 70°C Ambient:	0.5 Watt.	1.0 Watt.	2.0 Watt.
Derating:	Derating to 0 at 200°C	Derating to 0 at 200°C	Derating to 0 at 200°C
Resistance Range:	10R – 100K	3R3 – 390K	3R3 – 390K
Resistance Tolerance:	10% E12 series	10% E12 series	10% E12 series
Temperature Coefficient (ppm/°C):	<100R: -900 to ±300	>100R: -1300 to ±300	
Max. Working Voltage:	200V	300V	400V
Max. Overload Voltage:	400V	600V	800V
Dielectric Withstand Voltage:	500 volts	500 volts	700 volts
Impulse Withstanding Voltage*:	10 Kv	14 Kv	20 Kv

NB *: Please refer to Resistance to Pulse Circuit

Environmental

Operating Temperature Range:	-40°C to +200°C
Temperature Cycles (-40°C to 85°C, 5 cycles):	ΔR/R ± 2%
Load Life (1000 hours at 70°C):	ΔR/R ± 5%
Resistance to Solder Heat (360°C for 3 seconds):	ΔR/R ± 3%
Short Time Overload (2x rated voltage for 5 seconds):	ΔR/R ± 2%
Humidity (40°C, 95%RH 240 hrs.):	ΔR/R ± 5%

Resistance to Pulse Circuit

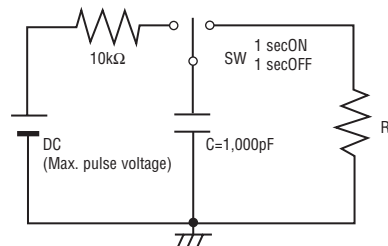

Resistance to Pulse Graphs CCR1

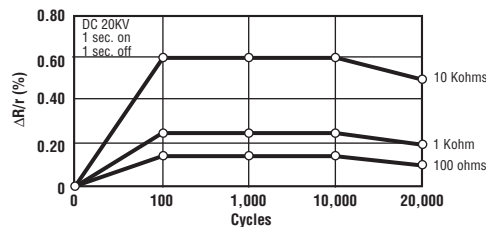

CCR2

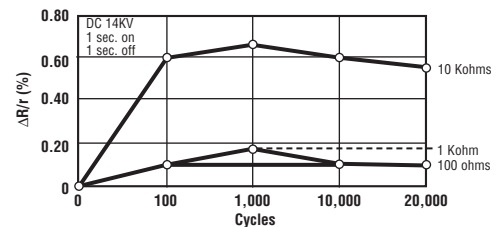

Dimensions

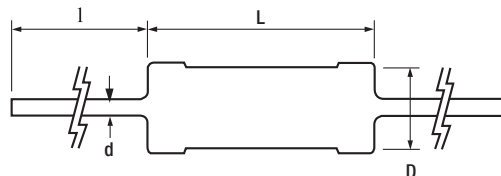

BULK	L	C (max)	D	d (nom)	l
CCR1/2	9.0 ± 1.0	11.1	3.5 ± 0.5	0.7	30 ± 3
CCR1	16.5 ± 1.0	19.0	5.5 ± 1.0	0.8	38 ± 3
CCR2	19.0 ± 1.0	22.5	7.0 ± 1.0	0.8	38 ± 3

Pulse Limiting Power (Po) One Pulse

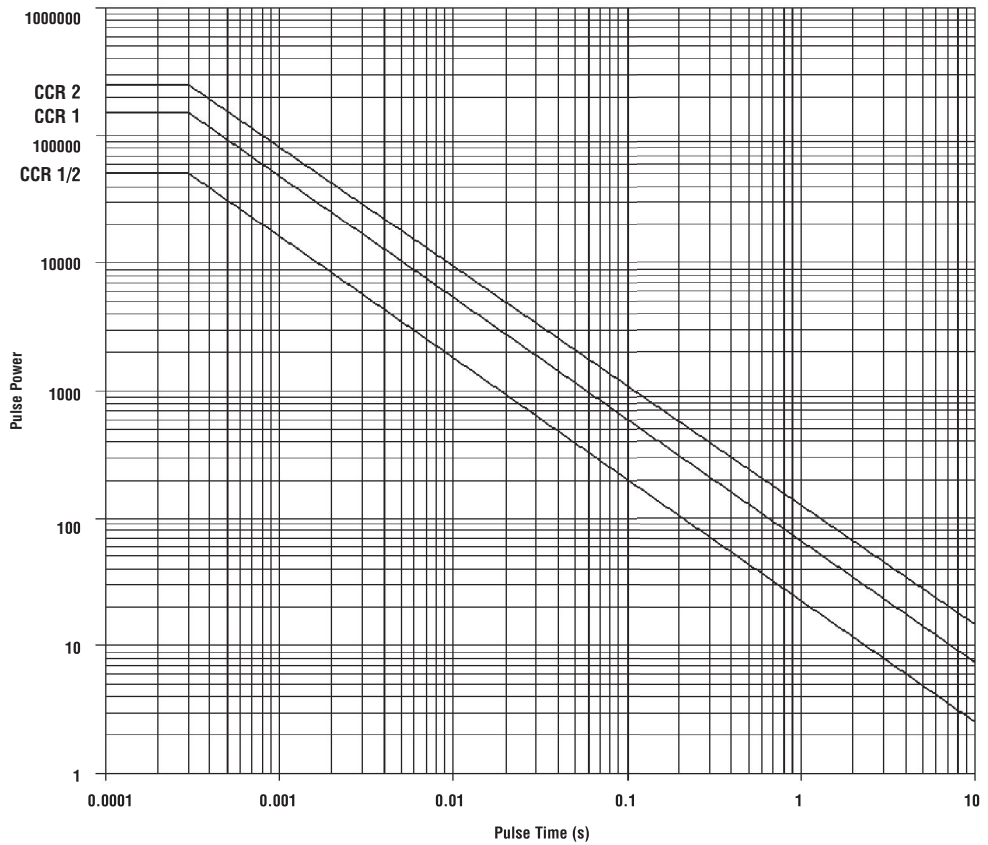

How to Order

CCR	1	10R	K	B
Common Part	Power Rating	Resistance Value	Tolerance	Packaging
CCR	- 0.5 Watt 1 - 1.0 Watt 2 - 2.0 Watt	10 ohm (10 ohms) 10R 1K ohms (1000 ohms) 1K0 100K ohms (100000 ohms) 100K	K - 10%	B - Bulk T - Taped

General Purpose Resistors

SIL Resistor Networks (Standard Packages)

SIL Resistor Networks
(Standard Packages)

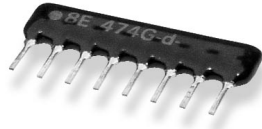

Fully automated production techniques, ensure this extensive range offers you consistently high standards of performance and reliability. Tyco Electronics Components can meet all your demands with its range of 4 to 13 resistor elements in common format and 3 to 7 resistor elements in isolated types. The substrate and lead frame provide exceptional strength and the resistors are protected from humidity and thermal shock by a hardwearing, solvent proof black coating. Tyco Electronics Components will also manufacture custom design networks for your special requirements. Please contact our Sales Action Desk for details.

Key Features

- 2% & 5% Tolerances
- Low Price Keeps Production Costs Down
- Solvent Proof Coating
- Very Wide Range
- Low Profile (5.08mm Max.)
- Very Strong Construction
- High Insulation Resistance

Characteristics - Electrical

Resistance Range:	10R to 1M0 (E24 Values)
Resistance Tolerances:	5%, 2%
Maximum Operating Voltage:	100 Volts
Power Rating @ 70°C (Series):	0.125 Watts
(Parallel):	0.200 Watts

Environmental

	Spec.	Test Method	
		JIS - C - 5202	MIL - R - 83401
Operating Temperature:	-55° ~ +125°C		
Resistance Temperature Coefficient:	±200ppm/°C	5.2 (B)	6.4.8
Short Time Overload:	±1.0%	5.5	4.6.10
Temperature Cycle:	±0.5%	7.4 (-55°C ~ 125°C)	4.6.3
Load Life:	±2.0%	7.10 (1000 hr.)	4.6.18(70°C 1000hr)
Moisture-Proof Load Life:	±2.0%	7.9 (1000 hr.)	
Moisture Resistance:	±1.0%		4.6.15
High Temperature Exposure:	±1.0%		4.6.19
Solderability:	95% coverage min.	6.5 (235°C/2s)	4.6.6
Solder Pot:	±0.5%	6.4 (260°C/10s)	4.6.14
Terminal Strength:	±0.5%	6.1 (1) 1kg/10s)	4.6.11

Circuit Configuration

Please Note: Common Terminal Devices (configuration E) are marked A on the body of the resistor. Isolated Terminal Devices (configuration M) are marked either B or C on the body of the resistor.

E. Common Terminal

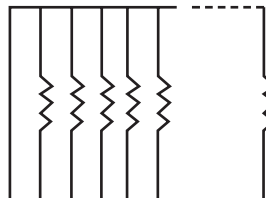

M. Isolated Terminal

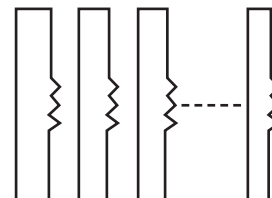

Power Derating Curve

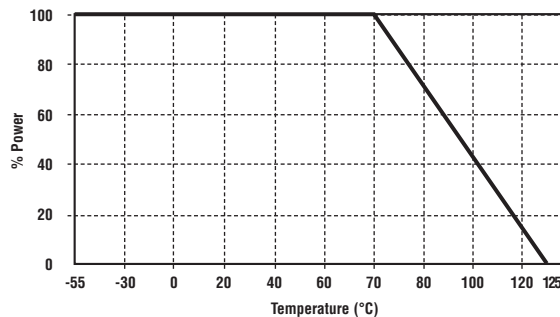

SIL Resistor Networks (Standard Packages) (Continued)

Dimensions

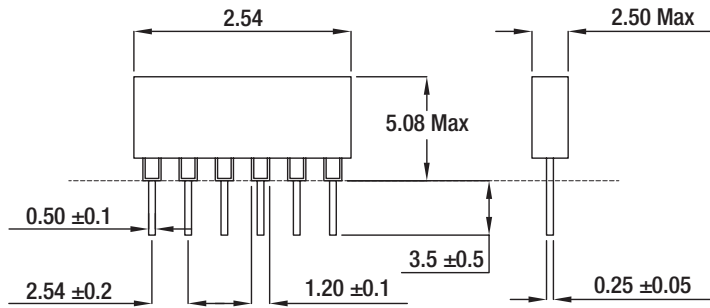

How to Order

SIL	08	E	472	J
Common Part	No. of Pins	Circuit Config.	Resistance Value	Tolerance
SIL	04 - 4 Pins 05 - 5 Pins 06 - 6 Pins 07 - 7 Pins 08 - 8 Pins 09 - 9 Pins 10 - 10 Pins 11 - 11 Pins 12 - 12 Pins 13 - 13 Pins 14 - 14 Pins	E - Common Terminals M - Isolated Terminals	The first two digits are significant figures of resistance value and the third denotes the number of zeros following. e.g. 220R: 221 4K7: 472 51K: 513 470K: 474	J - 5% G - 2%

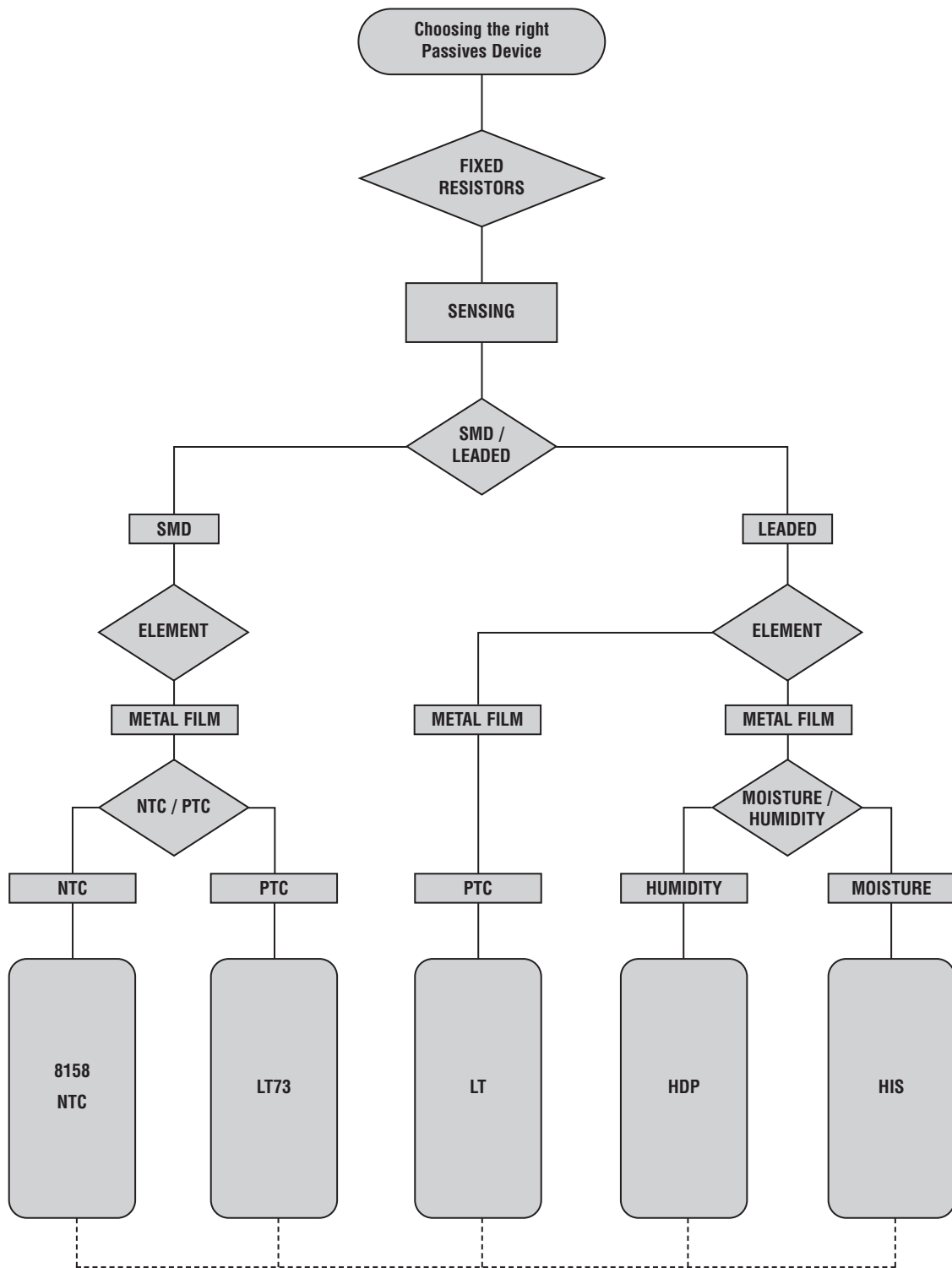

Other parameters to be aware of:	
Component Size	Temperature Coefficient
Power Rating Required	Resistance Tolerance
Pin Configuration	Current Rating
Voltage Rating	Ohmic Value Range

Product Overview

Sensing Resistors from the Citec and Neohm brands are used traditionally in temperature compensating circuits and other applications that require a resistance that varies according to ambient temperature.

Offering both negative (NTC) and positive (PTC) temperature coefficients in both surface mount and leaded types these products range from 0402 to 1206 size in surface mount and to 0.25W in a leaded version.

The product range is complemented by special products suitable for detecting moisture and humidity.

- NTC and PTC available
- SMD sizes down to 0402
- Temperature coefficient to 4350ppm
- Operating temperatures to 125°C
- Excellent linearity
- Wide value range
- Special products for detecting moisture and humidity

Max Power Rating Watts	Ohmic Value Range	Highest TCR	Tightest Tolerance	Family	Page
0.4W	40R - 500K	4350ppm	5%	8158	156-157
0.125W	100R - 150K	4100ppm	5%	NTC	158-159
0.125W	510R - 6K2	3900ppm	5%	LT73	160
0.25W	10R - 10K	3300ppm	5%	LT	161
0.002W	n/a	n/a	n/a	Moisture Sensor - HDP	162-163
0.0003W	50K	n/a	10%	Humidity Sensor - HIS	164-165

Type 8158 Series

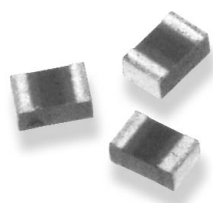

Tyco Electronic Components is pleased to offer this innovative range of Micro Chip Thermistors in 0402, 0603, 0805 and 1206 packages. These specialist Surface Mount N.T.C. devices are available in initial resistances between 40 ohms and 500K ohms, with a tolerance of 5% and a B constant of either 5% or 3%, with 10K available in 2% or 1% for 0603 and 0402 packaged devices. This series has a wide operating temperature range, -40°C to +125°C. The individual chip thermistors are not value coded.

Key Features

- Choice of Packages (0402, 0603, 0805, 1206)
- Suitable for Pick and Place
- Operating Temperature -40°C to +125°C
- Wide Value Range
- Embossed Tape on 7" Reels

Type 8158 Series

Characteristics - 04:02 Package

Part Number	Resistance (R25°C)	B-Value R25/85 (K)	Rated Wattage (mW)	Operating Temperature
81581E400J280J	40R	2800	40	-40°C to +125°C
81581E202J410J	2K0	4100	40	-40°C to +125°C
81581E302J410J	3K0	4100	40	-40°C to +125°C

06:03 Package

Part Number	Resistance (R25°C)	B-Value R25/85 (K)	Rated Wattage (mW)	Operating Temperature
81581J400J280J	40R	2800	150	-40°C to +125°C
81581J101J280J	100R	2800	150	-40°C to +125°C
81581J501J325J	500R	3250	150	-40°C to +125°C
81581J102J325J	1K0	3250	150	-40°C to +125°C
81581J202J410J	2K0	4100	150	-40°C to +125°C
81581J302J410J	3K0	4100	150	-40°C to +125°C
81581J502J355J	5K0	3550	150	-40°C to +125°C
81581J103J375J	10K	3750	150	-40°C to +125°C
81581J153J380J	15K	3800	150	-40°C to +125°C
81581J203J380J	20K	3800	150	-40°C to +125°C
81581J303J400J	30K	4000	150	-40°C to +125°C
81581J503J400J	50K	4000	150	-40°C to +125°C
81581J104J425J	100K	4150	150	-40°C to +125°C
81581J154J425J	150K	4250	150	-40°C to +125°C
81581J204J425J	200K	4250	150	-40°C to +125°C

08:05 Package

Part Number	Resistance (R25°C)	B-Value R25/85 (K)	Rated Wattage (mW)	Operating Temperature
81582A400J280J	40R	2800	300	-40°C to +125°C
81582A101J280J	100R	2800	300	-40°C to +125°C
81582A501J325J	500R	3250	300	-40°C to +125°C
81582A102J325J	1K0	3250	300	-40°C to +125°C
81582A202J410J	2K0	4100	300	-40°C to +125°C
81582A302J410J	3K0	4100	300	-40°C to +125°C
81582A502J355J	5K0	3550	300	-40°C to +125°C
81582A103J375J	10K	3750	300	-40°C to +125°C
81582A153J400J	15K	4000	300	-40°C to +125°C
81582A203J400J	20K	4000	300	-40°C to +125°C
81582A303J400J	30K	4000	300	-40°C to +125°C
81582A503J400J	50K	4000	300	-40°C to +125°C
81582A104J425J	100K	4250	300	-40°C to +125°C
81582A154J425J	150K	4250	300	-40°C to +125°C
81582A204J425J	200K	4250	300	-40°C to +125°C
81582A504J435J	500K	4350	300	-40°C to +125°C

Type 8158 Series (continued)

12:06 Package

Part Number	Resistance (R25°C)	B-Value R25/85 (K)	Rated Wattage (mW)	Operating Temperature
81582B101J280J	100R	2800	400	-40°C to +125°C
81582B501J325J	500R	3250	400	-40°C to +125°C
81582B102J325J	1K0	3250	400	-40°C to +125°C
81582B202J410J	2K0	4100	400	-40°C to +125°C
81582B302J410J	3K0	4100	400	-40°C to +125°C
81582B502J355J	5K0	3550	400	-40°C to +125°C
81582B103J375J	10K	3750	400	-40°C to +125°C
81582B153J400J	15K	3750	400	-40°C to +125°C
81582B203J400J	20K	4000	400	-40°C to +125°C
81582B303J400J	30K	4000	400	-40°C to +125°C
81582B503J400J	50K	4000	400	-40°C to +125°C
81582B104J425J	100K	4250	400	-40°C to +125°C
81582B154J425J	150K	4250	400	-40°C to +125°C
81582B204J425J	200K	4250	400	-40°C to +125°C
81582B504J435J	500K	4350	400	-40°C to +125°C

Dimensions

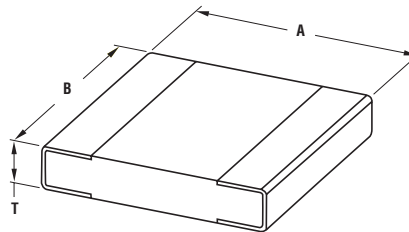

Case Size	A±0.2	B±0.2	T Max.
0402	1.0	0.5	0.7
0603	1.6	0.8	1.0
0805	2.0	1.25	1.2
1206	3.2	1.6	1.2

How to Order

8158	2A	103	J	375	J
Common Part	Case Size	Resistance Value	Tolerance	B Constant 25/85 (K)	B Constant Tolerance
8158 Chip Thermistor	1E - 0402 Package 1J - 0603 Package 2A - 0805 Package 2B - 1206 Package	The first two digits are significant figures of resistance value and the third denotes the number of zeros following. e.g. 100R: 101 10K: 103 100K: 104	J - 5%	280 - 2800 325 - 3250 355 - 3550 375 - 3750 400 - 4000 410 - 4100 425 - 4250 435 - 4350	J - 5% E - 3%

Sensing Resistors

Type NTC Series

Type NTC Series

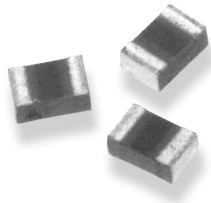

A range of NTC chip thermistors offering high thermal sensitivity. Suitable for temperature compensating circuits and other applications requiring a resistance that varies according to ambient temperature.

Key Features

- Two Package Sizes
- Suited to Automatic Pick and Place
- Components supplied unmarked
- -55°C to +125°C Temperature Range

Characteristics - Electrical

	NTC0603	NTC0805
Rated Power Max @ 55°C (mW):	63	125
Optimum Working Dissipation (mW):	0.4	1
Resistance Range (ohms) Min:	4K7	100
Max:	150K	150K
Tolerance on Resistance (%):	5 10	5 10
Code Letter:	J K	J K
Selection Series:	See Table	
β Constant:	See Table	
Tolerance on β (%):	5 (3% available on request)	
Thermal Time Constant (sec):	2	4
Thermal Dissipation Constant (mW/°C):	1.2	1.5
Operation Temp. Range (°C):	-55 to +125	

Dimensions

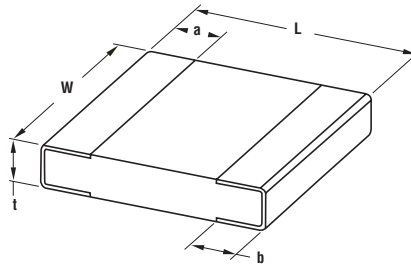

Style	L	W	t	a	b	Reel Qty
NTC0603	1.6 ± 0.15	0.8 ± 0.15	0.5 ± 0.1	0.3	0.3	5000
NTC0805	2.0	1.25	0.5	0.4	0.4	5000

Typical Performance Graph

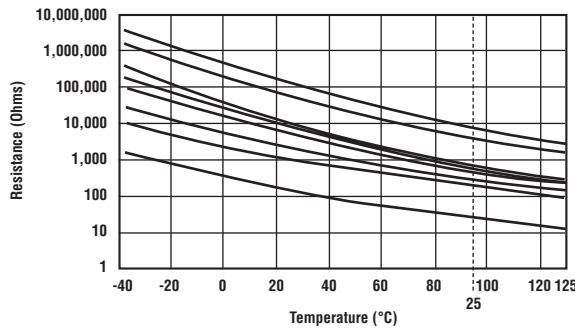

Derating Curve

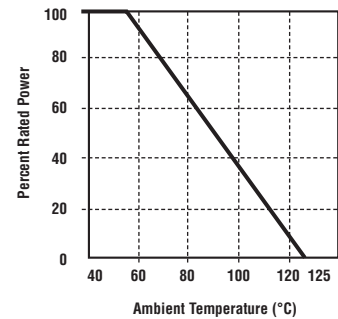

Resistance Value / β Constant

Resistance Value @ 25°C	β Constant	
	NTC0603	NTC0805
100	-----	2750
150	-----	2750
220	-----	2750
330	-----	2750
470	-----	2750
680	-----	2750
1K0	-----	2750
1K5	-----	3000
2K0	-----	3000
2K2	-----	3000
2K5	-----	3000
3K0	-----	3450
3K3	-----	3450

Type NTC Series (continued)

Resistance Value / β Constant (continued)

Resistance Value @ 25°C	β Constant	
	NTC0603	NTC0805
4K7	3500	3450
5K0	3500	3450
6K8	3500	3850
10K	3700	4100
15K	3850	4100
20K	3950	4100
22K	3950	4100
30K	3950	4100
33K	3950	4100
47K	4100	4100
50K	3950	3950
68K	4100	4100
100K	4100	4100
150K	4100	4100

Change of Resistance with Temperature

Temp (°C)	R = 1K0 ± 5%, β = 2750 ± 5%			R = 100K ± 5%, β = 4100 ± 5%		
	R Min	R Nom	R Max	R Min	R Nom	R Max
-55	23,619	29,443	36,612	11,437,698	15,492,485	20,932,275
-50	18,060	22,198	27,216	7,666,457	10,167,934	13,451,901
-45	13,973	16,944	20,496	5,229,571	6,797,677	8,813,894
-40	10,931	13,085	15,624	3,626,293	4,623,690	5,880,679
-35	8,639	10,214	12,047	2,553,502	3,196,281	3,990,860
-30	6,895	8,055	9,388	1,824,208	2,243,342	2,751,881
-25	5,552	6,414	7,390	1,320,987	1,597,136	1,926,187
-20	4,510	5,153	5,873	968,858	1,152,437	1,367,374
-15	3,693	4,175	4,709	719,179	842,136	983,650
-10	3,074	3,410	3,807	539,923	622,766	716,523
-5	2,532	2,806	3,103	409,704	465,752	528,143
0	2,118	2,326	2,548	314,048	352,049	393,661
5	1,784	1,941	2,107	243,038	268,796	296,539
10	1,511	1,630	1,754	189,795	207,195	225,625
15	1,288	1,377	1,469	149,493	161,161	173,305
20	1,103	1,170	1,239	118,711	126,434	134,321
25	950	1,000	1,050	95,000	100,000	105,000
30	822	859	895	76,585	79,707	82,749
35	715	741	767	62,174	64,002	65,719
40	624	643	660	50,811	51,752	52,579
45	548	560	571	41,789	42,128	42,363
50	482	490	496	34,578	34,512	34,360
55	426	430	433	28,776	28,445	28,048
60	378	379	380	24,081	23,582	23,035
65	337	336	334	20,258	19,658	19,029
70	301	298	295	17,128	16,475	15,807
75	270	266	261	14,551	13,877	13,201
80	243	238	232	12,420	11,746	11,081
85	219	213	207	10,647	9,988	9,347
90	198	192	186	9,167	8,532	7,921
95	180	173	167	7,924	7,319	6,743
100	163	157	150	6,877	6,304	5,765
105	149	142	135	5,990	5,452	4,950
110	136	129	122	5,237	4,733	4,266
115	125	118	111	4,594	4,123	3,691
120	114	108	101	4,044	3,605	3,206
125	105	99	92	3,571	3,162	2,794

How to Order

NTC	0603	J	2K0
Common Part NTC - Negative Temperature Coefficient Chip Thermistor	Size 0603 0805	Tolerance J - 5%	Value See table on previous page

Sensing Resistors

Type LT73 Series

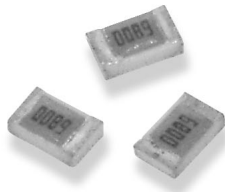

This tiny thin film chip is manufactured by sputtering pure metals onto a high purity alumina base. This process ensures the element remains stable in performance over a long life. The LT73 is equally suited to temperature compensation or thermal protection when incorporated within the appropriate electronics. This range of sensors are finished in a tough epoxy seal and are available on tape for high speed auto placement.

Key Features

- Solvent Resistant Coating
- Wide Value Range
- Excellent Linearity
- 08 05 Small Size
- Stocked in 3900ppm/°C
- Other TCR's Available to Order
- Supplied on Tape and Reel
- Power derates to zero at 125°C

Type LT73 Series

Characteristics - Electrical

	0805 Size (preferred) 2A	1206 Size 2B
Resistance Range:	510R - 3K0	510R - 6K2
Resistance Tolerance:	±5%	±5%
Rated Power at 70°C:	0.1 watt	0.125 watt
Max. Working Voltage @ T _a 70°C:	50 volts	75 volts
Max. Overload Voltage @ T _a 70°C:	100 volts	150 volts
Operating Temperature Range:	-40°C ~ +125°C	-40°C ~ +125°C
TCR Measuring Temperature:	+25°C ~ +75°C (See Graph)	+25°C ~ +75°C (See Graph)
TCR Tolerance:	± 10%	± 10%
Insulation Resistance:	More than 10 Meg	More than 10 Meg

Cleaning

The washing process is very important to ensure long term reliability because ionic impurity from flux may cause electrolytic corrosion of the metal film.

Short time Overload:	Rated Voltage x 2.5 maximum Overload Voltage for 5 seconds, whichever is less
Resistance to Soldering Heat:	260°C ± 5°C, 10 seconds ± 1 second
Solderability:	235°C ± 5°C, 3 seconds ± 0.5 second

Typical Performance Graph

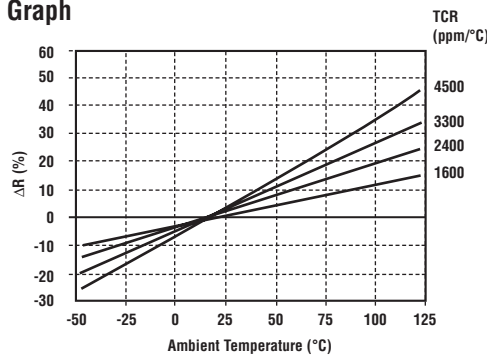

Dimensions

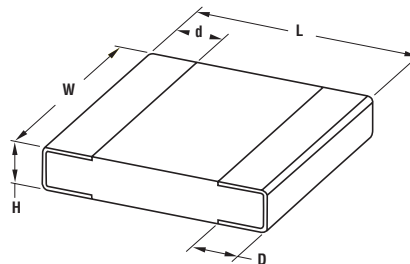

Chip Size	L	W	H	D	d	Weight /1000
2A-08.05	2.0±0.20	1.25±0.2	0.5±0.1	0.4±0.2	0.35±0.15	4.54g
2B-12.06	3.2±0.20	1.60±0.2	0.6±0.1	0.5±0.3	0.45±0.15	9.14g

How to Order

LT73	3900	2A	103	1K0	J
Common Part	T.C.R	Size	Resistance Value	Tolerance	Pack Style
LT73 - Standard	3000ppm/°C 3900ppm/°C	2A - 0.1W 2B - 0.125W	The first two digits are significant figures of resistance value and the third denotes the number of zeros following. e.g. 510R: 511 1K0: 102 3K0: 302	J ±5%	Taped - 4000 on Reel

Temperature Sensing Resistors (P.T.C. Thermistor)

Type LT Series

Type LT Series



The LT temperature sensing resistors are trimmed to specification on latest equipment. The case construction epoxy coated with axial leads, permits automatic insertion with available tape and reel packaging.

Key Features

- Insulated Package Style
- Positive Temperature Coefficient
- Supplied on Tape for Auto Insertion
- 0.16 Watts or 0.25 Watts Available
- Wide Operating Temperature Range
- Available with Pre Formed Leads

Characteristics - Electrical

	Style 16	Style 14
Resistance Range:	10R to 5K1	10R to 10K
Resistance Values:	E24 Grid	E24 Grid
Resistance Tolerance:	±5%	±5%
T.C.R. Tolerance:	±10%	±10%
Power Rating (Watts):	0.16 Watts at 70°C	0.25 Watts at 70°C
Withstand Voltage:	300V	500V
Short Time Overload:	2.5 x Rated Voltage for 5 Seconds	2.5 x Rated Voltage for 5 Seconds

Environmental

Operating Temperature Range:	-40°C to +125°C
Load Life at 70°C:	±3% +0.05 ohms (after 1000 hours)
Temperature Cycling:	-40°C to +125°C (5 cycles)
Moisture Resistance:	±3% +0.05 ohms (after 1000 hours at 40°C, 95% RH)

Dimensions

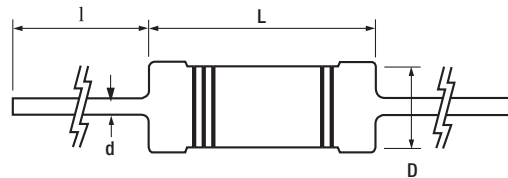

Style	L Max.	l	D	d
LTxxx16	3.4	15.0 ±0.3	1.7 ± 0.2	0.45
LTxxx14	6.8	15.0 ±0.3	2.3 ± 0.3	0.60

Marking

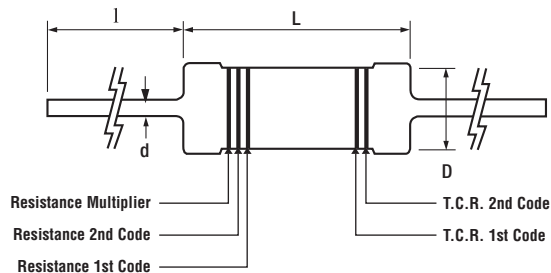

How to Order

LT	3000	16	T26	1K0	J
Common Part	T.C.R	Power Rating	Packaging	Resistance Value	Tolerance
LT - Linear Positive TCR Thermistor Sensor	3000 - 3000ppm/°C 3300 - 3300ppm/°C	16 - 0.16 Watts 14 - 0.25 Watts	T-26 Taped and Ammo Packed	1 ohm (1 ohm) 1R0 1K ohm (1000 ohms) 1K0	J - 5%

Moisture Sensing Resistors

Type HDP Series

Type HDP Series

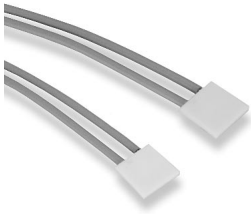

The HDP low cost thick film sensor can be used to detect the presence of moisture in a multitude of applications. The HDP sensor can be provided with wire leads and mounted to a carrier plate. This sensor is well established and represents an effective and reliable indicator in sensitive electronic equipment, where excessive moisture could cause catastrophic failure.

Key Features

- Swift Response (Switch)
- Stable Load Life
- Wire Terminations
- Mounting Plate Option
- Range of Applications

Characteristics - Electrical

Rated Voltage:	0.8 volts maximum
Rated Power:	2mW
Operating Temperature Range:	1°C to 60°C
Operating Humidity Range:	0% to 100% RH
Storage Temperature Range:	-40°C to +85°C
Response Speed:	10 seconds to reach minimum 100K

Mechanical

Vibration (10 - 55 Hz):	After 2 minutes x 1.5mm amplitude x,y & z
Lead Wire Strength:	1 Kg applied vertically 10 seconds
Lead Wire Type:	UL1571 AWG # 28

Environmental

Moisture Cycling:	1000 cycles
Temperature Cycling (-40°C to 701°C):	30 minutes each x 5 cycles
High Temperature:	85°C x 1000 hours
Low Temperature:	-40 °C x 1000 hours
Low Humidity (5% RH at 40°C):	1000 hours
High Humidity Load Life (90 - 95% RH, 40°C, 0.8v):	1000 hours

Dimensions HDP07SN

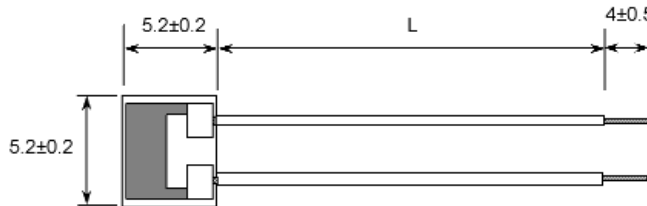

HDP07SC

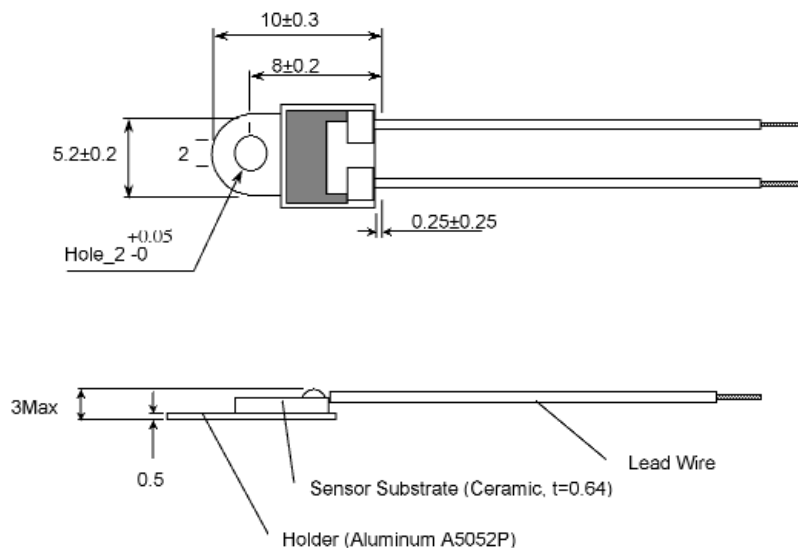

Moisture Response Curve

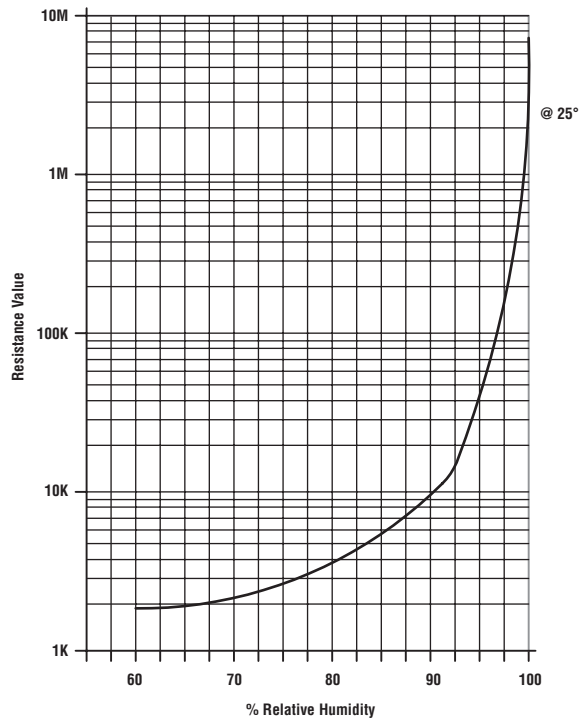

User Notes

1. Never touch sensor surface. Finger salts will damage sensor. Also prevent adhesives, flux, solder, oil, grease, solvents (all types) and any ionised material, e.g. tap water making contact with sensor.
2. Do not allow smoke, breath or steam to directly impact sensor surface. Clean only with cotton wool buds penetrated by steam if necessary.

How to Order

HDP	07	SC	1
Common Part	Element Type	Assembly Type	Lead Length
HDP - Moisture Sensor	07 - High Response (See Table Above)	SN - Element and Lead Wire SC - Add Carrier and Plate	1 - L = 50mm 2 - L = 100mm

Type HIS Series

Type HIS Series

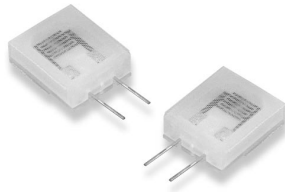

This is a high quality, highly responsive polymer film humidity sensor enclosed in a polypropylene moulded case with filter and with the option of pcb pins at 2.5 mm. centres or lead wires subject to consultation with our technical sales group. Attractively priced, this is an excellent resistive sensor which is suited to a wide range of market applications.

Key Features

- Highly Responsive
- Humidity Range 20% RH - 90% RH
- Suited to AC Power Supply Only
- Temperature Range -25°C - +60°C
- Custom Connectors Possible
- Robust Construction
- Complete Test Data Available

Characteristics - Electrical

Rated Voltage:	1V AC sine wave (effective value) or square wave of AC 5V
Rated Wattage:	0.3 mW
Operating Temperature Range:	-20°C - +60°C
Operating Humidity Range:	20 ~ 90% RH
Operating Frequency:	50Hz ~ 1kHz
Humidity Response Characteristics:	30% RH to 90% RH
Resistance Value:	45K to 55K ohms (at 25°C, 50 ± 5% RH)

N.B. Sensor must not be subject to 100% RH - Dew Drops

Environment Conditions of Humidity Sensor

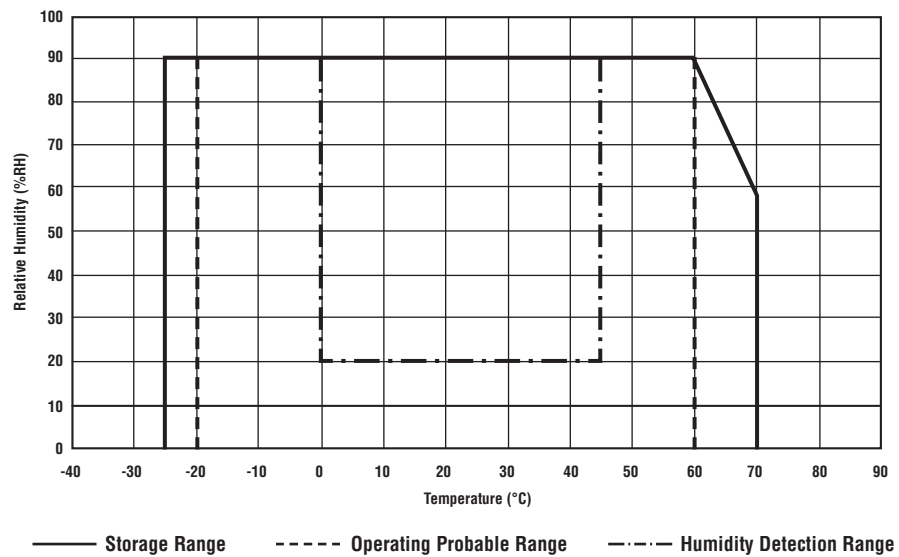

Temperature Humidity Characteristics

Temp (°C)	Relative Humidity (%RH)							
	20	30	40	50	60	70	80	90
5	68057	4915	824.0	218.5	72.27	28.15	12.09	5.35
10	35993	3076	566.4	151.4	49.94	19.30	8.21	3.70
15	19368	1948	375.3	98.80	33.47	13.36	5.68	2.70
20	10800	1130	240.0	68.00	22.70	9.60	4.33	2.08
25	5916	694	149.9	45.80	17.20	7.17	3.28	1.66
30	3450	420	94.6	31.00	11.30	5.20	2.60	1.42
35	2053	268	60.6	21.28	8.05	3.81	2.05	1.22
40	1235	172	40.8	14.97	6.11	3.00	1.71	1.05
45	740	115	30.2	11.01	4.76	2.43	1.46	0.93

User Notes

1. Ensure that no water, alcohol, oil or finger salts make contact with the sensor element
2. Ensure A.C. power source only
3. Do not directly expose sensor to smoke from cigarettes, breath or excessive steam.
4. Do not use for medical apparatus involving risk of affecting life.

Temperature Humidity Characteristics (continued)

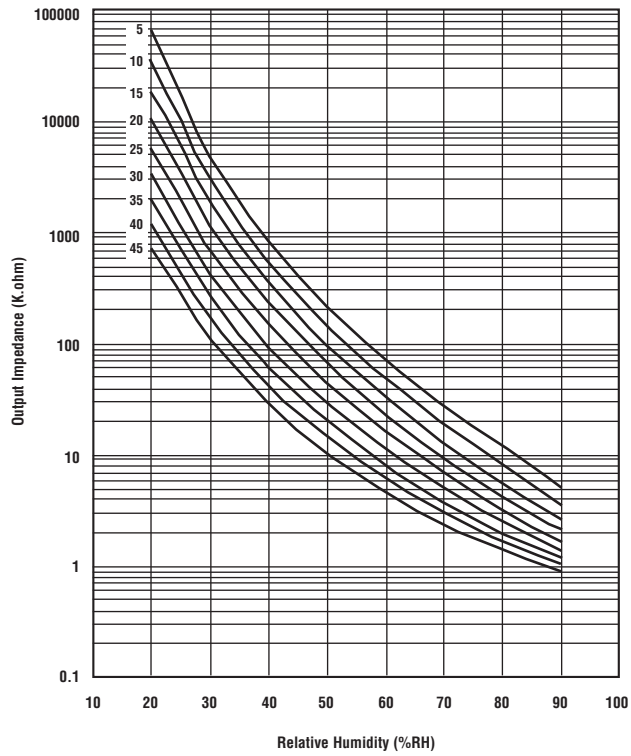

Dimensions

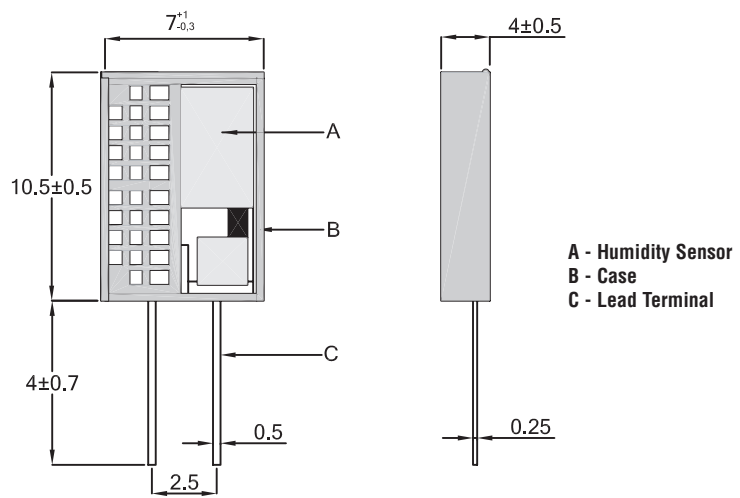

How to Order

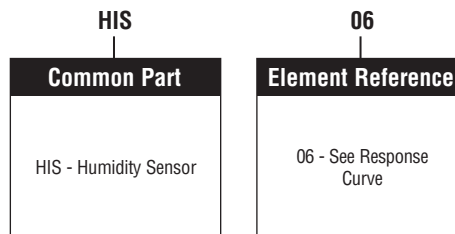

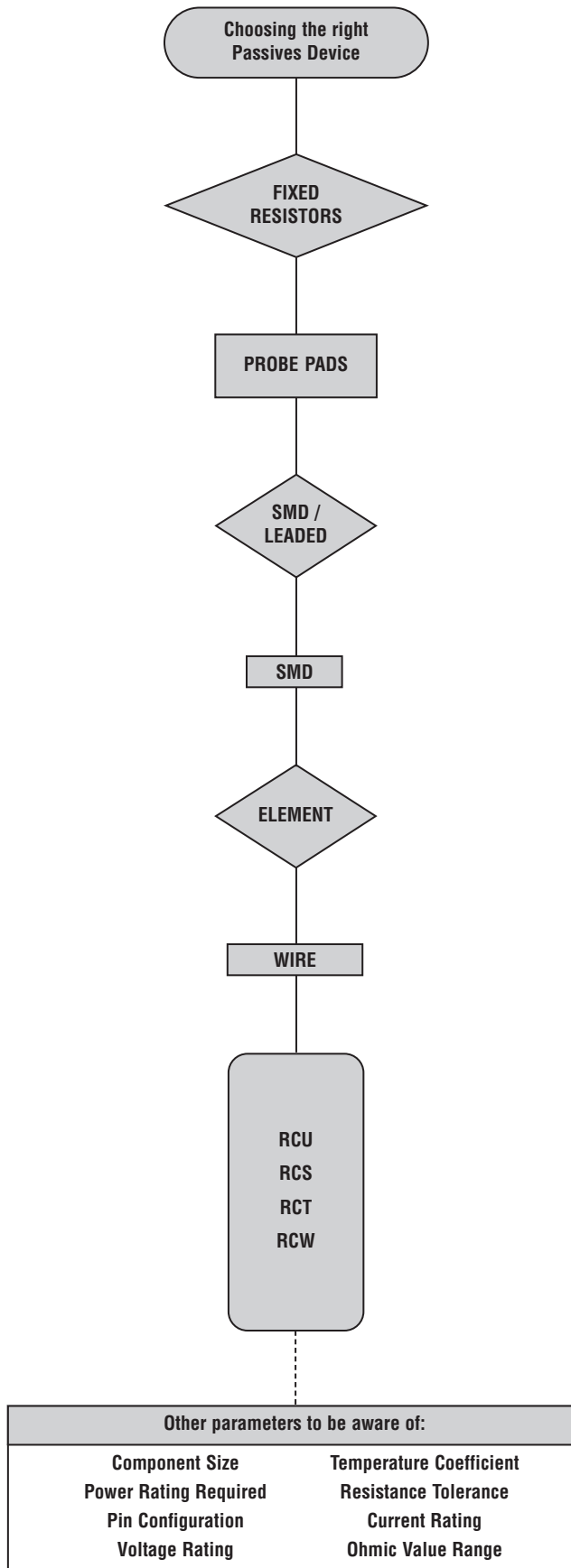

Probe Pads

Product Overview

A range of unique Surface mount devices from the Citec brand enable safe probing of circuitry when testing, adjusting, setting up, measuring and repairing tiny electronic circuitry. Available in 3 different surface mount sizes and packaged for automatic placement.

- Small dimensions
- SMD 0603, 0805 and 1206 sizes
- Suitable for flow or reflow soldering
- High current capability

Value	Maximum Current	Size	Family	Page
< 50 milliohms	2 amps	0603, 0805 and 1206	<i>RC</i>	168

Type RC Series

Type RC Series



Characteristics - Electrical

Type	Dimensions	Resistance	Weight	Current	Operating Temperature
RCU	1.60 x 0.80	Less Than 50 Milli Ohms	6.3mg	2 Amps	-55°C - +125°C
RCT	2.00 x 1.20		13.8mg		
RCS	3.2 x 1.60 (Height 1.25)		21.4mg		
RCW	3.2 x 1.60 (Height 1.25)		26.6mg		

A range of unique surface mount devices. Avoid damage to sensitive tiny electronic circuits by incorporating these probe pads in the circuitry. A choice of three sizes relate to standard chip footprint areas. These probe pads are packaged on tape for high speed automatic placement. They enable safe probing of circuitry when adjusting, setting up measuring or repairing tiny electronic circuitry.

Key Features

- Small Dimensions
- Suited to Flow or Reflow Soldering
- Solder Only Sticks to Plated Base
- Packaged on Tape and Reeled
- High Current Handling
- Unaffected by Climatic Changes

Dimensions RCU (0603)

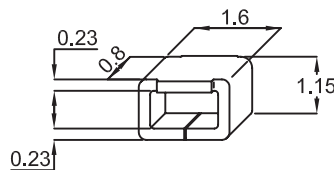

RCT (0805)

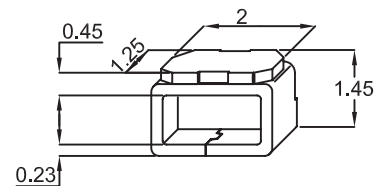

RSC (1206)

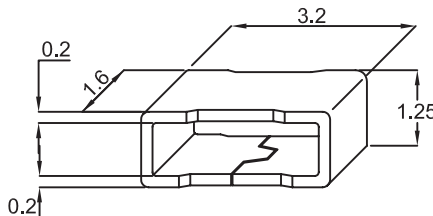

RCW (1206)

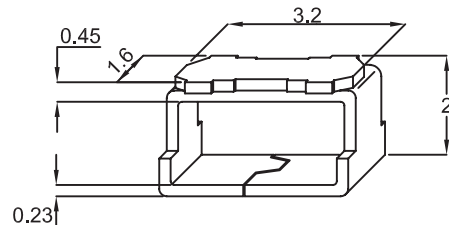

How to Order

RCU-	OC
Common Part	Reel Size
RCU-- 06:03	OC - 2000 Pieces (7" Reel)
RCT-- 08:05	OD - 5000 Pieces (10" Reel)
RCS-- 12:06	
RCW-- 12:06	

Компания «Океан Электроники» предлагает заключение долгосрочных отношений при поставках импортных электронных компонентов на взаимовыгодных условиях!

Наши преимущества:

- Поставка оригинальных импортных электронных компонентов напрямую с производств Америки, Европы и Азии, а так же с крупнейших складов мира;
- Широкая линейка поставок активных и пассивных импортных электронных компонентов (более 30 млн. наименований);
- Поставка сложных, дефицитных, либо снятых с производства позиций;
- Оперативные сроки поставки под заказ (от 5 рабочих дней);
- Экспресс доставка в любую точку России;
- Помощь Конструкторского Отдела и консультации квалифицированных инженеров;
- Техническая поддержка проекта, помощь в подборе аналогов, поставка прототипов;
- Поставка электронных компонентов под контролем ВП;
- Система менеджмента качества сертифицирована по Международному стандарту ISO 9001;
- При необходимости вся продукция военного и аэрокосмического назначения проходит испытания и сертификацию в лаборатории (по согласованию с заказчиком);
- Поставка специализированных компонентов военного и аэрокосмического уровня качества (Xilinx, Altera, Analog Devices, Intersil, Interpoint, Microsemi, Actel, Aeroflex, Peregrine, VPT, Syfer, Eurofarad, Texas Instruments, MS Kennedy, Miteq, Cobham, E2V, MA-COM, Hittite, Mini-Circuits, General Dynamics и др.);

Компания «Океан Электроники» является официальным дистрибьютором и эксклюзивным представителем в России одного из крупнейших производителей разъемов военного и аэрокосмического назначения «JONHON», а так же официальным дистрибьютором и эксклюзивным представителем в России производителя высокотехнологичных и надежных решений для передачи СВЧ сигналов «FORSTAR».



JONHON

«JONHON» (основан в 1970 г.)

Разъемы специального, военного и аэрокосмического назначения:

(Применяются в военной, авиационной, аэрокосмической, морской, железнодорожной, горно- и нефтедобывающей отраслях промышленности)

«FORSTAR» (основан в 1998 г.)

ВЧ соединители, коаксиальные кабели,
кабельные сборки и микроволновые компоненты:

(Применяются в телекоммуникациях гражданского и специального назначения, в средствах связи, РЛС, а так же военной, авиационной и аэрокосмической отраслях промышленности).



Телефон: 8 (812) 309-75-97 (многоканальный)

Факс: 8 (812) 320-03-32

Электронная почта: ocean@oceanchips.ru

Web: <http://oceanchips.ru/>

Адрес: 198099, г. Санкт-Петербург, ул. Калинина, д. 2, корп. 4, лит. А