

MJD112, NJVMJD112T4G (NPN), MJD117, NJVMJD117T4G (PNP)

Complementary Darlington Power Transistors

DPAK For Surface Mount Applications

Designed for general purpose power and switching such as output or driver stages in applications such as switching regulators, converters, and power amplifiers.

Features

- Lead Formed for Surface Mount Applications in Plastic Sleeves (No Suffix)
- Straight Lead Version in Plastic Sleeves ("-1" Suffix)
- Electrically Similar to Popular TIP31 and TIP32 Series
- NJV Prefix for Automotive and Other Applications Requiring Unique Site and Control Change Requirements; AEC-Q101 Qualified and PPAP Capable
- Pb-Free Packages are Available*



ON Semiconductor®

<http://onsemi.com>

SILICON
POWER TRANSISTORS
2 AMPERES
100 VOLTS, 20 WATTS



DPAK
CASE 369C



DPAK-3
CASE 369D

MARKING DIAGRAMS



DPAK

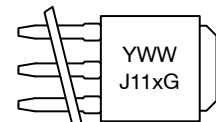

DPAK-3

A = Assembly Location
Y = Year
WW = Work Week
x = 2 or 7
G = Pb-Free Package

ORDERING INFORMATION

See detailed ordering and shipping information in the package dimensions section on page 8 of this data sheet.

*For additional information on our Pb-Free strategy and soldering details, please download the ON Semiconductor Soldering and Mounting Techniques Reference Manual, SOLDERRM/D.

MJD112, NJVMJD112T4G (NPN), MJD117, NJVMJD117T4G (PNP)

MAXIMUM RATINGS

Rating	Symbol	Max	Unit
Collector–Emitter Voltage	V_{CEO}	100	Vdc
Collector–Base Voltage	V_{CB}	100	Vdc
Emitter–Base Voltage	V_{EB}	5	Vdc
Collector Current Continuous Peak	I_C	2 4	Adc
Base Current	I_B	50	mAdc
Total Power Dissipation @ $T_C = 25^\circ\text{C}$ Derate above 25°C	P_D	20 0.16	W W/ $^\circ\text{C}$
Total Power Dissipation (Note1) @ $T_A = 25^\circ\text{C}$ Derate above 25°C	P_D	1.75 0.014	W W/ $^\circ\text{C}$
Operating and Storage Junction Temperature Range	T_J, T_{stg}	-65 to +150	$^\circ\text{C}$

Stresses exceeding Maximum Ratings may damage the device. Maximum Ratings are stress ratings only. Functional operation above the Recommended Operating Conditions is not implied. Extended exposure to stresses above the Recommended Operating Conditions may affect device reliability.

THERMAL CHARACTERISTICS

Characteristic	Symbol	Max	Unit
Thermal Resistance, Junction–to–Case	$R_{\theta JC}$	6.25	$^\circ\text{C}/\text{W}$
Thermal Resistance, Junction–to–Ambient (Note 1)	$R_{\theta JA}$	71.4	$^\circ\text{C}/\text{W}$

1. These ratings are applicable when surface mounted on the minimum pad sizes recommended.

MJD112, NJVMJD112T4G (NPN), MJD117, NJVMJD117T4G (PNP)

ELECTRICAL CHARACTERISTICS (T_C = 25°C unless otherwise noted)

Characteristic	Symbol	Min	Max	Unit
OFF CHARACTERISTICS				
Collector-Emitter Sustaining Voltage (Note 2) (I _C = 30 mA _{dc} , I _B = 0)	V _{CEO(sus)}	100	–	V _{dc}
Collector Cutoff Current (V _{CE} = 50 V _{dc} , I _B = 0)	I _{CEO}	–	20	μA _{dc}
Collector Cutoff Current (V _{CB} = 100 V _{dc} , I _E = 0)	I _{CBO}	–	20	μA _{dc}
Emitter Cutoff Current (V _{BE} = 5 V _{dc} , I _C = 0)	I _{EBO}	–	2	mA _{dc}
Collector-Cutoff Current (V _{CB} = 80 V _{dc} , I _E = 0)	I _{CBO}	–	10	μA _{dc}
Emitter-Cutoff Current (V _{BE} = 5 V _{dc} , I _C = 0)	I _{EBO}	–	2	mA _{dc}
ON CHARACTERISTICS				
DC Current Gain (I _C = 0.5 A _{dc} , V _{CE} = 3 V _{dc}) (I _C = 2 A _{dc} , V _{CE} = 3 V _{dc}) (I _C = 4 A _{dc} , V _{CE} = 3 V _{dc})	h _{FE}	500 1000 200	– 12,000 –	–
Collector-Emitter Saturation Voltage (I _C = 2 A _{dc} , I _B = 8 mA _{dc}) (I _C = 4 A _{dc} , I _B = 40 mA _{dc})	V _{CE(sat)}	– –	2 3	V _{dc}
Base-Emitter Saturation Voltage (I _C = 4 A _{dc} , I _B = 40 mA _{dc})	V _{BE(sat)}	–	4	V _{dc}
Base-Emitter On Voltage (I _C = 2 A _{dc} , V _{CE} = 3 V _{dc})	V _{BE(on)}	–	2.8	V _{dc}
DYNAMIC CHARACTERISTICS				
Current-Gain – Bandwidth Product (I _C = 0.75 A _{dc} , V _{CE} = 10 V _{dc} , f = 1 MHz)	f _T	25	–	MHz
Output Capacitance (V _{CB} = 10 V _{dc} , I _E = 0, f = 0.1 MHz) MJD117, NJVMJD117T4G MJD112, NJVMJD112T4G	C _{ob}	– –	200 100	pF

2. Pulse Test: Pulse Width ≤ 300 μs, Duty Cycle ≤ 2%.

*These ratings are applicable when surface mounted on the minimum pad sizes recommended.

MJD112, NJVMJD112T4G (NPN), MJD117, NJVMJD117T4G (PNP)



Figure 1. Switching Times Test Circuit

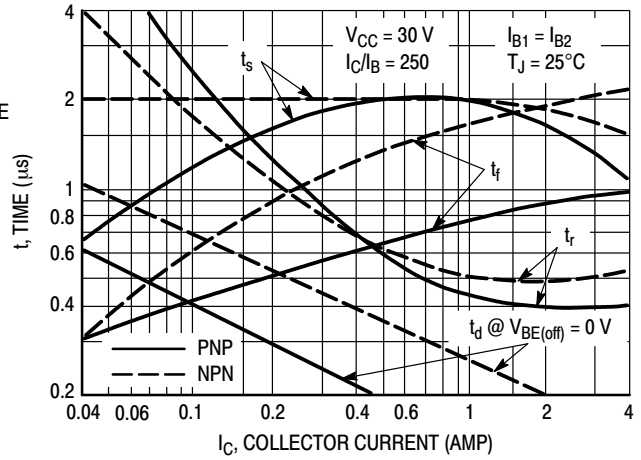

Figure 2. Switching Times

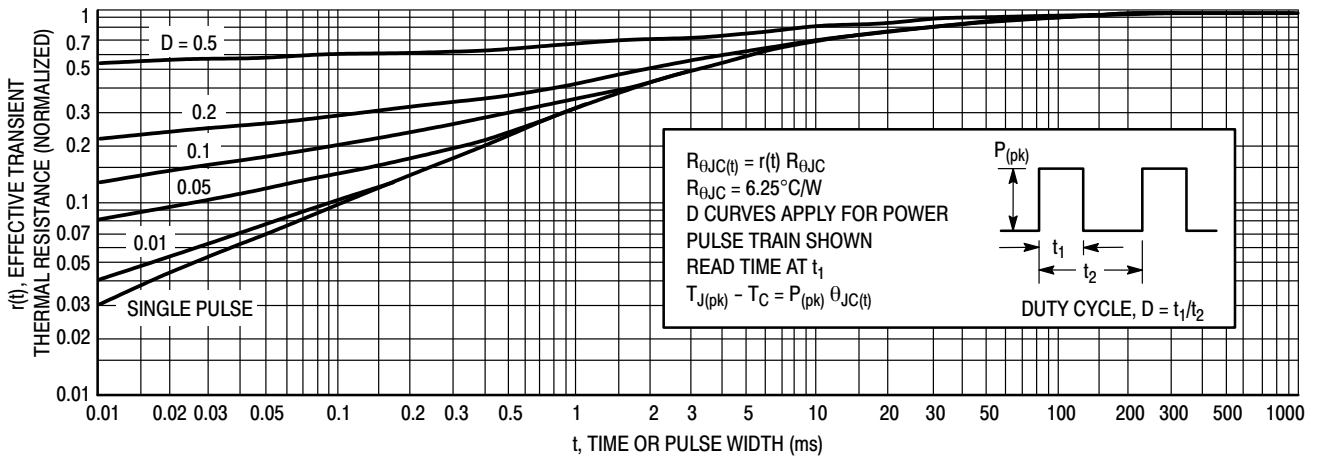

Figure 3. Thermal Response

MJD112, NJVMJD112T4G (NPN), MJD117, NJVMJD117T4G (PNP)

ACTIVE-REGION SAFE-OPERATING AREA

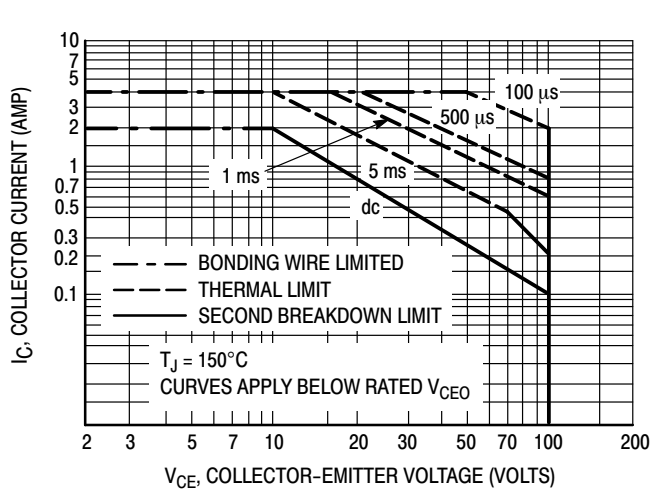

Figure 4. Maximum Rated Forward Biased Safe Operating Area

There are two limitations on the power handling ability of a transistor: average junction temperature and second breakdown. Safe operating area curves indicate $I_C - V_{CE}$ limits of the transistor that must be observed for reliable operation; i.e., the transistor must not be subjected to greater dissipation than the curves indicate.

The data of Figures 5 and 6 is based on $T_{J(pk)} = 150^\circ\text{C}$; T_C is variable depending on conditions. Second breakdown pulse limits are valid for duty cycles to 10% provided $T_{J(pk)} < 150^\circ\text{C}$. $T_{J(pk)}$ may be calculated from the data in Figure 4. At high case temperatures, thermal limitations will reduce the power that can be handled to values less than the limitations imposed by second breakdown.



Figure 5. Power Derating

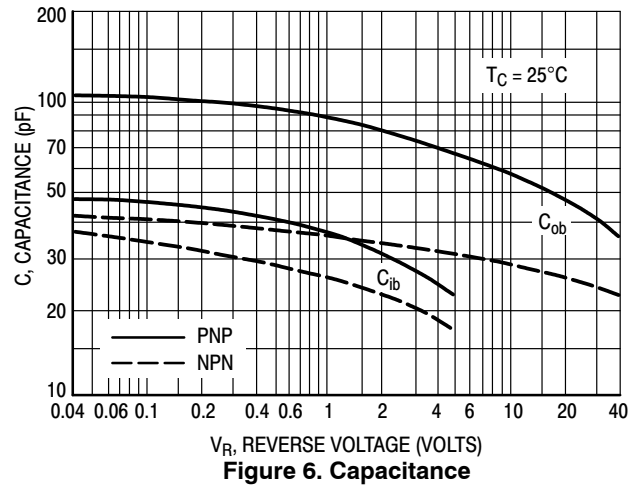

Figure 6. Capacitance

MJD112, NJVMJD112T4G (NPN), MJD117, NJVMJD117T4G (PNP)

TYPICAL ELECTRICAL CHARACTERISTICS

NPN MJD112

PNP MJD117



Figure 7. DC Current Gain



Figure 8. Collector Saturation Region



Figure 9. "On Voltages"

MJD112, NJVMJD112T4G (NPN), MJD117, NJVMJD117T4G (PNP)

NPN MJD112

PNP MJD117

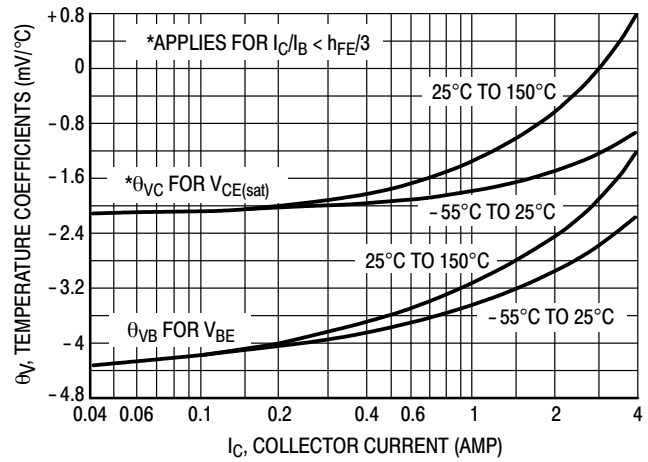
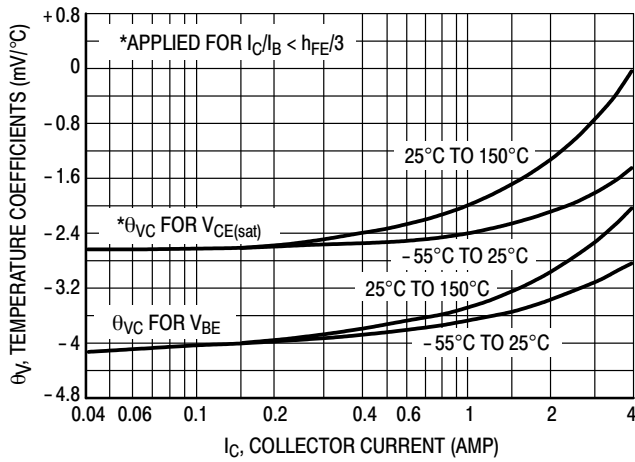

Figure 10. Temperature Coefficients

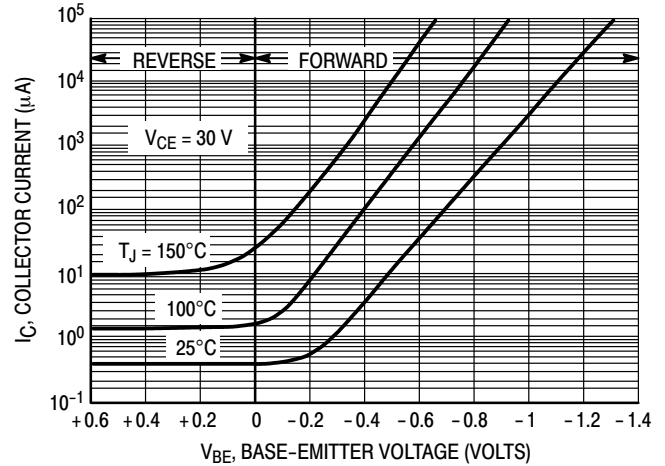
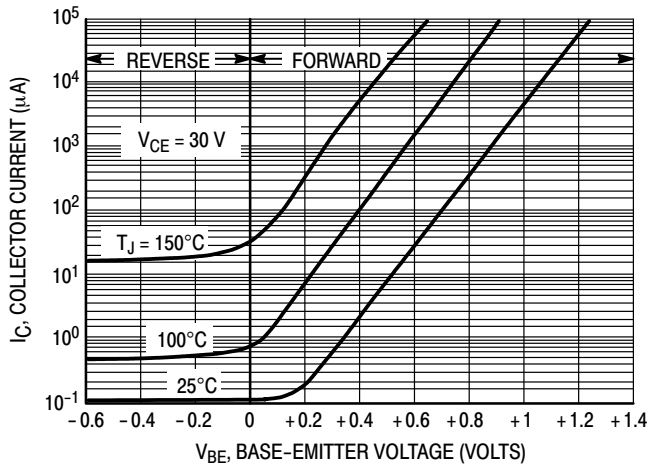

Figure 11. Collector Cut-Off Region

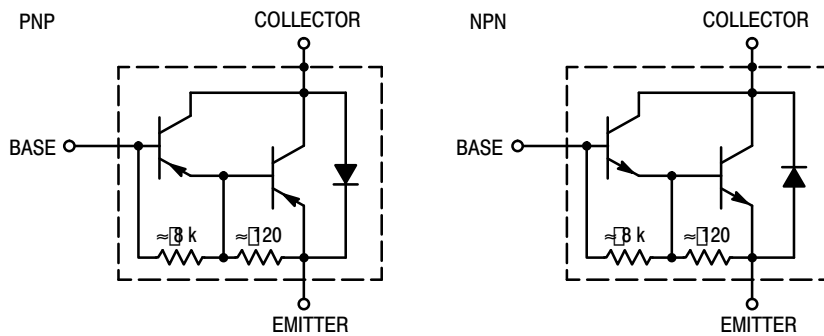

Figure 12. Darlington Schematic

MJD112, NJVMJD112T4G (NPN), MJD117, NJVMJD117T4G (PNP)

ORDERING INFORMATION

Device	Package Type	Package	Shipping [†]
MJD112	DPAK	369C	75 Units / Rail
MJD112G	DPAK (Pb-Free)		
MJD112-001	DPAK-3	369D	
MJD112-1G	DPAK-3 (Pb-Free)		
MJD112RL	DPAK	369C	1,800 Tape & Reel
MJD112RLG	DPAK (Pb-Free)		
MJD112T4	DPAK		
MJD112T4G	DPAK (Pb-Free)		
NJVMJD112T4G	DPAK (Pb-Free)	369D	75 Units / Rail
MJD117	DPAK		
MJD117G	DPAK (Pb-Free)		
MJD117-001	DPAK-3		
MJD117-1G	DPAK-3 (Pb-Free)	369C	2,500 Tape & Reel
MJD117T4	DPAK		
MJD117T4G	DPAK (Pb-Free)		
NJVMJD117T4G	DPAK (Pb-Free)		

†For information on tape and reel specifications, including part orientation and tape sizes, please refer to our Tape and Reel Packaging Specifications Brochure, BRD8011/D.

MJD112, NJVMJD112T4G (NPN), MJD117, NJVMJD117T4G (PNP)

PACKAGE DIMENSIONS

DPAK CASE 369C-01 ISSUE D

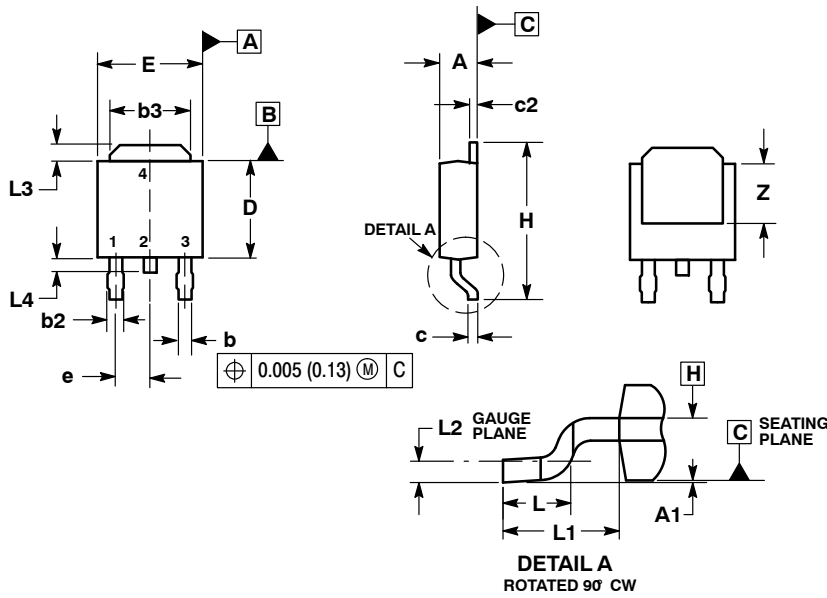

NOTES:

1. DIMENSIONING AND TOLERANCING PER ASME Y14.5M, 1994.
2. CONTROLLING DIMENSION: INCHES.
3. THERMAL PAD CONTOUR OPTIONAL WITHIN DIMENSIONS b3, L3 and Z.
4. DIMENSIONS D AND E DO NOT INCLUDE MOLD FLASH, PROTRUSIONS, OR BURRS. MOLD FLASH, PROTRUSIONS, OR GATE BURRS SHALL NOT EXCEED 0.006 INCHES PER SIDE.
5. DIMENSIONS D AND E ARE DETERMINED AT THE OUTERMOST EXTREMES OF THE PLASTIC BODY.
6. DATUMS A AND B ARE DETERMINED AT DATUM PLANE H.

DIM	INCHES		MILLIMETERS	
	MIN	MAX	MIN	MAX
A	0.086	0.094	2.18	2.38
A1	0.000	0.005	0.00	0.13
b	0.025	0.035	0.63	0.89
b2	0.030	0.045	0.76	1.14
b3	0.180	0.215	4.57	5.46
c	0.018	0.024	0.46	0.61
c2	0.018	0.024	0.46	0.61
D	0.235	0.245	5.97	6.22
E	0.250	0.265	6.35	6.73
e	0.090 BSC		2.29 BSC	
H	0.370	0.410	9.40	10.41
L	0.055	0.070	1.40	1.78
L1	0.108 REF		2.74 REF	
L2	0.020 BSC		0.51 BSC	
L3	0.035	0.050	0.89	1.27
L4	---	0.040	---	1.01
Z	0.155	---	3.93	---

STYLE 1:

1. BASE
2. COLLECTOR
3. EMITTER
4. COLLECTOR

SOLDERING FOOTPRINT*



SCALE 3:1 ($\frac{\text{mm}}{\text{inches}}$)

*For additional information on our Pb-Free strategy and soldering details, please download the ON Semiconductor Soldering and Mounting Techniques Reference Manual, SOLDERRM/D.

MJD112, NJVMJD112T4G (NPN), MJD117, NJVMJD117T4G (PNP)

PACKAGE DIMENSIONS

IPAK
CASE 369D-01
ISSUE C



- NOTES:
1. DIMENSIONING AND TOLERANCING PER ANSI Y14.5M, 1982.
 2. CONTROLLING DIMENSION: INCH.

DIM	INCHES		MILLIMETERS	
	MIN	MAX	MIN	MAX
A	0.235	0.245	5.97	6.35
B	0.250	0.265	6.35	6.73
C	0.086	0.094	2.19	2.38
D	0.027	0.035	0.69	0.88
E	0.018	0.023	0.46	0.58
F	0.037	0.045	0.94	1.14
G	0.090	BSC	2.29	BSC
H	0.034	0.040	0.87	1.01
J	0.018	0.023	0.46	0.58
K	0.350	0.380	8.89	9.65
R	0.180	0.215	4.45	5.45
S	0.025	0.040	0.63	1.01
V	0.035	0.050	0.89	1.27
Z	0.155	---	3.93	---

- STYLE 1:
1. BASE
 2. COLLECTOR
 3. EMITTER
 4. COLLECTOR

ON Semiconductor and are registered trademarks of Semiconductor Components Industries, LLC (SCILLC). SCILLC reserves the right to make changes without further notice to any products herein. SCILLC makes no warranty, representation or guarantee regarding the suitability of its products for any particular purpose, nor does SCILLC assume any liability arising out of the application or use of any product or circuit, and specifically disclaims any and all liability, including without limitation special, consequential or incidental damages. "Typical" parameters which may be provided in SCILLC data sheets and/or specifications can and do vary in different applications and actual performance may vary over time. All operating parameters, including "Typicals" must be validated for each customer application by customer's technical experts. SCILLC does not convey any license under its patent rights nor the rights of others. SCILLC products are not designed, intended, or authorized for use as components in systems intended for surgical implant into the body, or other applications intended to support or sustain life, or for any other application in which the failure of the SCILLC product could create a situation where personal injury or death may occur. Should Buyer purchase or use SCILLC products for any such unintended or unauthorized application, Buyer shall indemnify and hold SCILLC and its officers, employees, subsidiaries, affiliates, and distributors harmless against all claims, costs, damages, and expenses, and reasonable attorney fees arising out of, directly or indirectly, any claim of personal injury or death associated with such unintended or unauthorized use, even if such claim alleges that SCILLC was negligent regarding the design or manufacture of the part. SCILLC is an Equal Opportunity/Affirmative Action Employer. This literature is subject to all applicable copyright laws and is not for resale in any manner.

PUBLICATION ORDERING INFORMATION

LITERATURE FULFILLMENT:
Literature Distribution Center for ON Semiconductor
P.O. Box 5163, Denver, Colorado 80217 USA
Phone: 303-675-2175 or 800-344-3860 Toll Free USA/Canada
Fax: 303-675-2176 or 800-344-3867 Toll Free USA/Canada
Email: orderlit@onsemi.com

N. American Technical Support: 800-282-9855 Toll Free USA/Canada
Europe, Middle East and Africa Technical Support:
Phone: 421 33 790 2910
Japan Customer Focus Center
Phone: 81-3-5817-1050

ON Semiconductor Website: www.onsemi.com
Order Literature: <http://www.onsemi.com/orderlit>
For additional information, please contact your local Sales Representative

Компания «Океан Электроники» предлагает заключение долгосрочных отношений при поставках импортных электронных компонентов на взаимовыгодных условиях!

Наши преимущества:

- Поставка оригинальных импортных электронных компонентов напрямую с производств Америки, Европы и Азии, а так же с крупнейших складов мира;
- Широкая линейка поставок активных и пассивных импортных электронных компонентов (более 30 млн. наименований);
- Поставка сложных, дефицитных, либо снятых с производства позиций;
- Оперативные сроки поставки под заказ (от 5 рабочих дней);
- Экспресс доставка в любую точку России;
- Помощь Конструкторского Отдела и консультации квалифицированных инженеров;
- Техническая поддержка проекта, помощь в подборе аналогов, поставка прототипов;
- Поставка электронных компонентов под контролем ВП;
- Система менеджмента качества сертифицирована по Международному стандарту ISO 9001;
- При необходимости вся продукция военного и аэрокосмического назначения проходит испытания и сертификацию в лаборатории (по согласованию с заказчиком);
- Поставка специализированных компонентов военного и аэрокосмического уровня качества (Xilinx, Altera, Analog Devices, Intersil, Interpoint, Microsemi, Actel, Aeroflex, Peregrine, VPT, Syfer, Eurofarad, Texas Instruments, MS Kennedy, Miteq, Cobham, E2V, MA-COM, Hittite, Mini-Circuits, General Dynamics и др.);

Компания «Океан Электроники» является официальным дистрибьютором и эксклюзивным представителем в России одного из крупнейших производителей разъемов военного и аэрокосмического назначения «JONHON», а так же официальным дистрибьютором и эксклюзивным представителем в России производителя высокотехнологичных и надежных решений для передачи СВЧ сигналов «FORSTAR».



JONHON

«JONHON» (основан в 1970 г.)

Разъемы специального, военного и аэрокосмического назначения:

(Применяются в военной, авиационной, аэрокосмической, морской, железнодорожной, горно- и нефтедобывающей отраслях промышленности)

«FORSTAR» (основан в 1998 г.)

ВЧ соединители, коаксиальные кабели, кабельные сборки и микроволновые компоненты:

(Применяются в телекоммуникациях гражданского и специального назначения, в средствах связи, РЛС, а так же военной, авиационной и аэрокосмической отраслях промышленности).



Телефон: 8 (812) 309-75-97 (многоканальный)

Факс: 8 (812) 320-03-32

Электронная почта: ocean@oceanchips.ru

Web: <http://oceanchips.ru/>

Адрес: 198099, г. Санкт-Петербург, ул. Калинина, д. 2, корп. 4, лит. А