

Thyristor \ Diode Module

$$V_{RRM} = 2 \times 1600 \text{ V}$$

$$I_{TAV} = 116 \text{ A}$$

$$V_T = 1.28 \text{ V}$$

Phase leg

Part number

MCD95-16io1

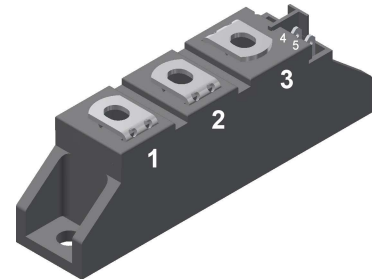

Backside: isolated

 E72873



Features / Advantages:

- Thyristor for line frequency
- Planar passivated chip
- Long-term stability
- Direct Copper Bonded Al₂O₃-ceramic

Applications:

- Line rectifying 50/60 Hz
- Softstart AC motor control
- DC Motor control
- Power converter
- AC power control
- Lighting and temperature control

Package: TO-240AA

- Isolation Voltage: 4800 V~
- Industry standard outline
- RoHS compliant
- Soldering pins for PCB mounting
- Base plate: DCB ceramic
- Reduced weight
- Advanced power cycling

Disclaimer Notice

Information furnished is believed to be accurate and reliable. However, users should independently evaluate the suitability of and test each product selected for their own applications. Littelfuse products are not designed for, and may not be used in, all applications. Read complete Disclaimer Notice at www.littelfuse.com/disclaimer-electronics.



| Rectifier | | | Ratings | | | |
|----------------|--|--|---------------------------|------|------|-------------------|
| Symbol | Definition | Conditions | min. | typ. | max. | Unit |
| $V_{RSM/DSM}$ | max. non-repetitive reverse/forward blocking voltage | $T_{VJ} = 25^{\circ}C$ | | | 1700 | V |
| $V_{RRM/DRM}$ | max. repetitive reverse/forward blocking voltage | $T_{VJ} = 25^{\circ}C$ | | | 1600 | V |
| I_{RD} | reverse current, drain current | $V_{R/D} = 1600 V$ | $T_{VJ} = 25^{\circ}C$ | | 200 | μA |
| | | $V_{R/D} = 1600 V$ | $T_{VJ} = 125^{\circ}C$ | | 5 | mA |
| V_T | forward voltage drop | $I_T = 150 A$ | $T_{VJ} = 25^{\circ}C$ | | 1.29 | V |
| | | $I_T = 300 A$ | | | 1.50 | V |
| | | $I_T = 150 A$ | $T_{VJ} = 125^{\circ}C$ | | 1.28 | V |
| | | $I_T = 300 A$ | | | 1.70 | V |
| I_{TAV} | average forward current | $T_C = 85^{\circ}C$ | $T_{VJ} = 125^{\circ}C$ | | 116 | A |
| $I_{T(RMS)}$ | RMS forward current | 180° sine | | | 182 | A |
| V_{T0} | threshold voltage | } for power loss calculation only | $T_{VJ} = 125^{\circ}C$ | | 0.85 | V |
| r_T | slope resistance | | | | 2.4 | m Ω |
| R_{thJC} | thermal resistance junction to case | | | | 0.22 | K/W |
| R_{thCH} | thermal resistance case to heatsink | | | 0.2 | | K/W |
| P_{tot} | total power dissipation | | $T_C = 25^{\circ}C$ | | 455 | W |
| I_{TSM} | max. forward surge current | $t = 10 \text{ ms}; (50 \text{ Hz}), \text{ sine}$ | $T_{VJ} = 45^{\circ}C$ | | 2.25 | kA |
| | | $t = 8,3 \text{ ms}; (60 \text{ Hz}), \text{ sine}$ | $V_R = 0 V$ | | 2.43 | kA |
| | | $t = 10 \text{ ms}; (50 \text{ Hz}), \text{ sine}$ | $T_{VJ} = 125^{\circ}C$ | | 1.92 | kA |
| | | $t = 8,3 \text{ ms}; (60 \text{ Hz}), \text{ sine}$ | $V_R = 0 V$ | | 2.07 | kA |
| I^2t | value for fusing | $t = 10 \text{ ms}; (50 \text{ Hz}), \text{ sine}$ | $T_{VJ} = 45^{\circ}C$ | | 25.3 | kA ² s |
| | | $t = 8,3 \text{ ms}; (60 \text{ Hz}), \text{ sine}$ | $V_R = 0 V$ | | 24.6 | kA ² s |
| | | $t = 10 \text{ ms}; (50 \text{ Hz}), \text{ sine}$ | $T_{VJ} = 125^{\circ}C$ | | 18.3 | kA ² s |
| | | $t = 8,3 \text{ ms}; (60 \text{ Hz}), \text{ sine}$ | $V_R = 0 V$ | | 17.7 | kA ² s |
| C_J | junction capacitance | $V_R = 400 V \quad f = 1 \text{ MHz}$ | $T_{VJ} = 25^{\circ}C$ | | 119 | pF |
| P_{GM} | max. gate power dissipation | $t_p = 30 \mu s$ | $T_C = 125^{\circ}C$ | | 10 | W |
| | | $t_p = 300 \mu s$ | | | 5 | W |
| P_{GAV} | average gate power dissipation | | | | 0.5 | W |
| $(di/dt)_{cr}$ | critical rate of rise of current | $T_{VJ} = 125^{\circ}C; f = 50 \text{ Hz}$ | repetitive, $I_T = 250 A$ | | 150 | A/ μs |
| | | $t_p = 200 \mu s; di_G/dt = 0.45 A/\mu s;$ $I_G = 0.45 A; V = \frac{2}{3} V_{DRM}$ | non-repet., $I_T = 116 A$ | | 500 | A/ μs |
| $(dv/dt)_{cr}$ | critical rate of rise of voltage | $V = \frac{2}{3} V_{DRM}$ $R_{GK} = \infty; \text{ method 1 (linear voltage rise)}$ | $T_{VJ} = 125^{\circ}C$ | | 1000 | V/ μs |
| V_{GT} | gate trigger voltage | $V_D = 6 V$ | $T_{VJ} = 25^{\circ}C$ | | 2.5 | V |
| | | | $T_{VJ} = -40^{\circ}C$ | | 2.6 | V |
| I_{GT} | gate trigger current | $V_D = 6 V$ | $T_{VJ} = 25^{\circ}C$ | | 150 | mA |
| | | | $T_{VJ} = -40^{\circ}C$ | | 200 | mA |
| V_{GD} | gate non-trigger voltage | $V_D = \frac{2}{3} V_{DRM}$ | $T_{VJ} = 125^{\circ}C$ | | 0.2 | V |
| I_{GD} | gate non-trigger current | | | | 10 | mA |
| I_L | latching current | $t_p = 10 \mu s$ | $T_{VJ} = 25^{\circ}C$ | | 450 | mA |
| | | $I_G = 0.45 A; di_G/dt = 0.45 A/\mu s$ | | | | |
| I_H | holding current | $V_D = 6 V \quad R_{GK} = \infty$ | $T_{VJ} = 25^{\circ}C$ | | 200 | mA |
| t_{gd} | gate controlled delay time | $V_D = \frac{1}{2} V_{DRM}$ | $T_{VJ} = 25^{\circ}C$ | | 2 | μs |
| | | $I_G = 0.45 A; di_G/dt = 0.45 A/\mu s$ | | | | |
| t_q | turn-off time | $V_R = 100 V; I_T = 150 A; V = \frac{2}{3} V_{DRM}$ $di/dt = 10 A/\mu s \quad dv/dt = 20 V/\mu s \quad t_p = 200 \mu s$ | $T_{VJ} = 100^{\circ}C$ | | 185 | μs |



| Package TO-240AA | | | | Ratings | | | |
|------------------|--|----------------------|-------------------------------------|---------|------|------|--|
| Symbol | Definition | Conditions | min. | typ. | max. | Unit | |
| I_{RMS} | RMS current | per terminal | | | 200 | A | |
| T_{VJ} | virtual junction temperature | | -40 | | 125 | °C | |
| T_{op} | operation temperature | | -40 | | 100 | °C | |
| T_{stg} | storage temperature | | -40 | | 125 | °C | |
| Weight | | | | | 81 | g | |
| M_D | mounting torque | | 2.5 | | 4 | Nm | |
| M_T | terminal torque | | 2.5 | | 4 | Nm | |
| $d_{Spp/App}$ | creepage distance on surface striking distance through air | terminal to terminal | 13.0 | 9.7 | | mm | |
| $d_{Spb/Apb}$ | | terminal to backside | 16.0 | 16.0 | | mm | |
| V_{ISOL} | isolation voltage | t = 1 second | | 4800 | | V | |
| | | t = 1 minute | 50/60 Hz, RMS; $I_{ISOL} \leq 1$ mA | 4000 | | V | |



| Ordering | Ordering Number | Marking on Product | Delivery Mode | Quantity | Code No. |
|----------|-----------------|--------------------|---------------|----------|----------|
| Standard | MCD95-16IO1 | MCD95-16IO1 | Box | 36 | 464872 |

Equivalent Circuits for Simulation

* on die level

$T_{VJ} = 125^{\circ}\text{C}$



Thyristor

| | | | |
|--------------|--------------------|------|----|
| $V_{0\ max}$ | threshold voltage | 0.85 | V |
| $R_{0\ max}$ | slope resistance * | 1.2 | mΩ |



Outlines TO-240AA

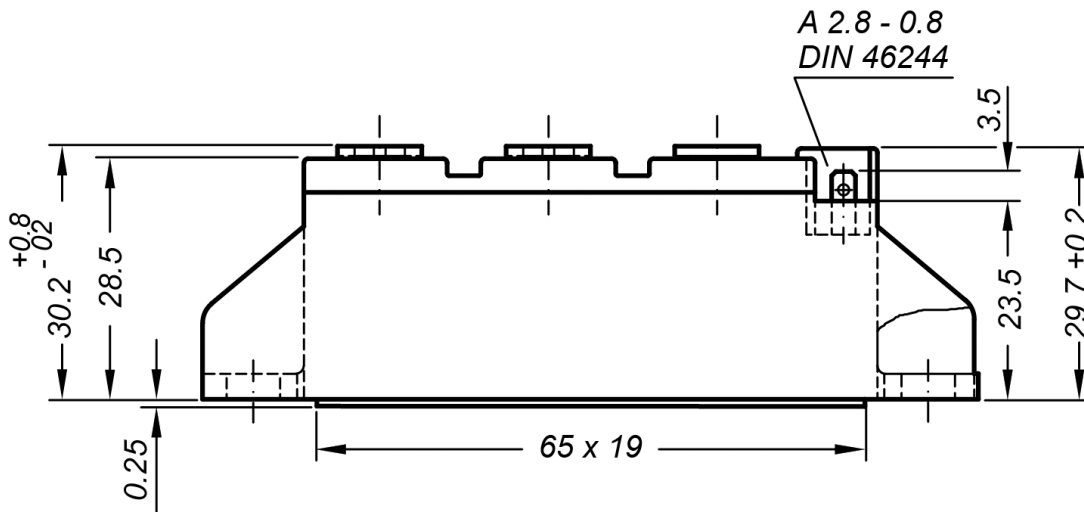

General tolerance: DIN ISO 2768 class „c“

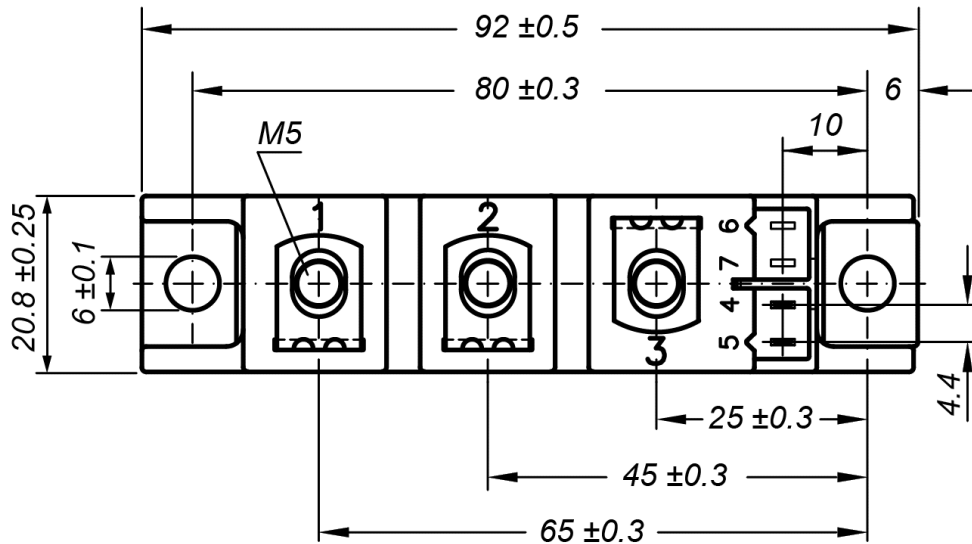

Optional accessories for modules

Keyed gate/cathode twin plugs with wire length = 350 mm, gate = white, cathode = red
Type ZY 200L (L = Left for pin pair 4/5) UL 758, style 3751



Thyristor



Fig. 1 Surge overload current I_{TSM} ,
 I_{FSM} : Crest value, t: duration

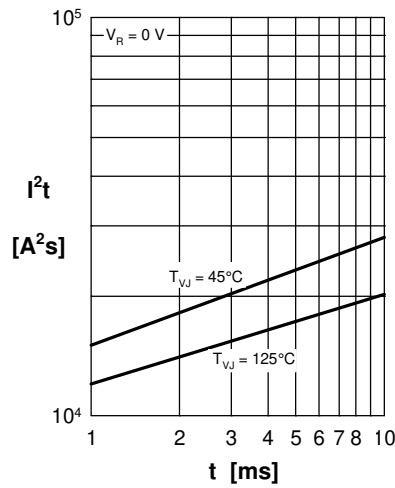

Fig. 2 I^2t versus time (1-10 ms)

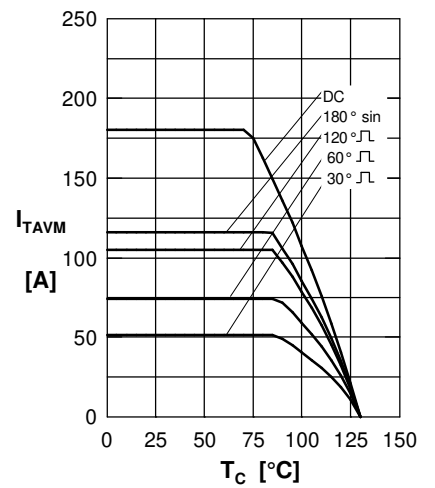

Fig. 3 Max. forward current
at case temperature

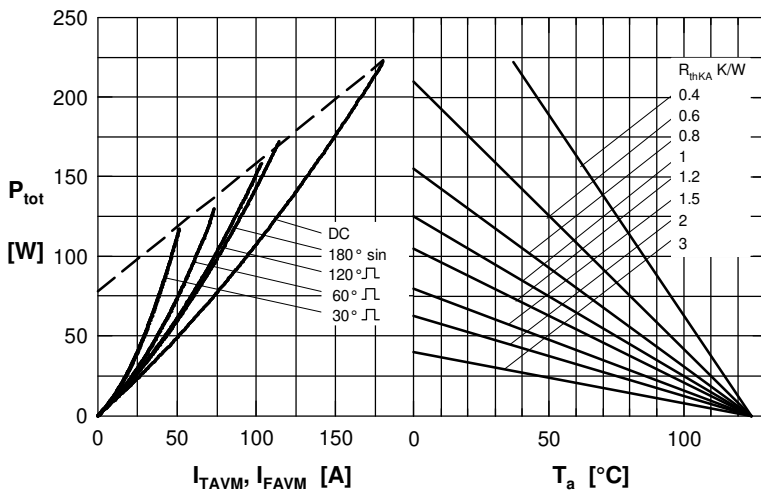

Fig. 4 Power dissipation vs. on-state current & ambient temperature
(per thyristor or diode)

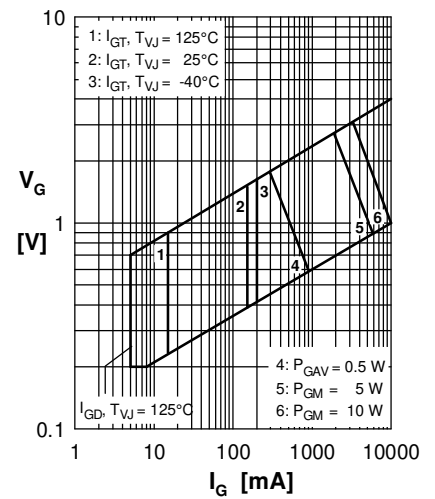

Fig. 5 Gate trigger characteristics



Fig. 6 Three phase rectifier bridge: Power dissipation vs. direct
output current and ambient temperature



Fig. 7 Gate controlled delay time



Rectifier

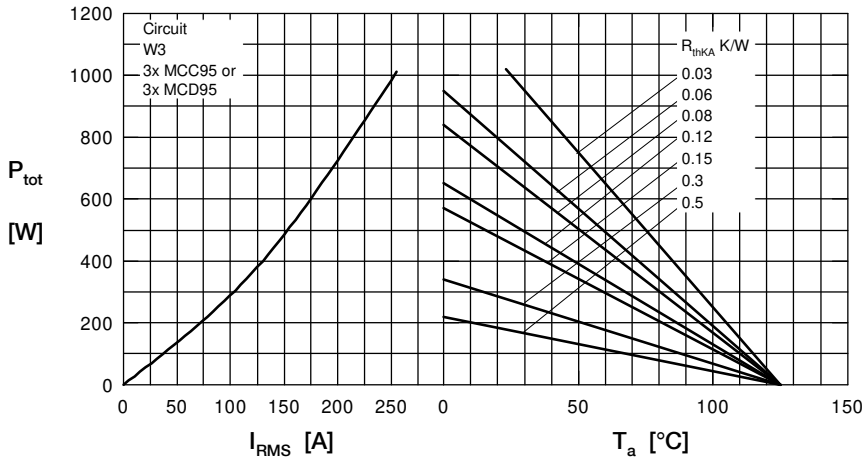

Fig. 8 Three phase AC-controller: Power dissipation versus RMS output current and ambient temperature

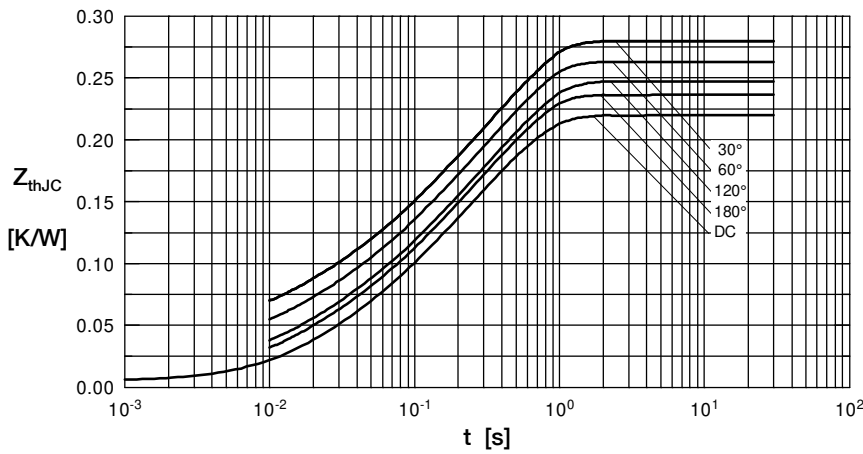

Fig. 9 Transient thermal impedance junction to case (per thyristor/diode)

R_{thJC} for various conduction angles d:

| d | R_{thJC} [K/W] |
|------|------------------|
| DC | 0.22 |
| 180° | 0.23 |
| 120° | 0.25 |
| 60° | 0.27 |
| 30° | 0.28 |

Constants for Z_{thJC} calculation:

| i | R_{thi} [K/W] | t_i [s] |
|---|-----------------|-----------|
| 1 | 0.0066 | 0.0019 |
| 2 | 0.0678 | 0.0477 |
| 3 | 0.1456 | 0.3440 |

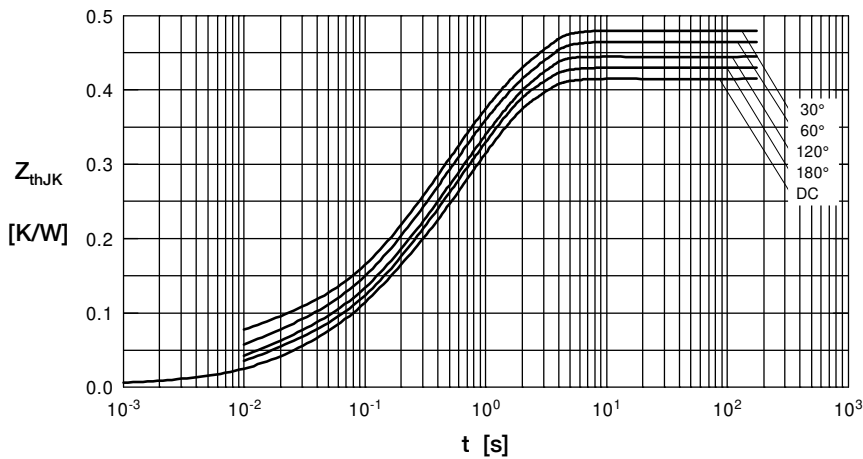

Fig. 10 Transient thermal impedance junction to heatsink (per thyristor/diode)

R_{thJK} for various conduction angles d:

| d | R_{thJK} [K/W] |
|------|------------------|
| DC | 0.42 |
| 180° | 0.43 |
| 120° | 0.45 |
| 60° | 0.47 |
| 30° | 0.48 |

Constants for Z_{thJK} calculation:

| i | R_{thi} [K/W] | t_i [s] |
|---|-----------------|-----------|
| 1 | 0.0066 | 0.0019 |
| 2 | 0.0678 | 0.0477 |
| 3 | 0.1456 | 0.3440 |
| 4 | 0.2000 | 1.3200 |

Компания «Океан Электроники» предлагает заключение долгосрочных отношений при поставках импортных электронных компонентов на взаимовыгодных условиях!

Наши преимущества:

- Поставка оригинальных импортных электронных компонентов напрямую с производств Америки, Европы и Азии, а так же с крупнейших складов мира;
- Широкая линейка поставок активных и пассивных импортных электронных компонентов (более 30 млн. наименований);
- Поставка сложных, дефицитных, либо снятых с производства позиций;
- Оперативные сроки поставки под заказ (от 5 рабочих дней);
- Экспресс доставка в любую точку России;
- Помощь Конструкторского Отдела и консультации квалифицированных инженеров;
- Техническая поддержка проекта, помощь в подборе аналогов, поставка прототипов;
- Поставка электронных компонентов под контролем ВП;
- Система менеджмента качества сертифицирована по Международному стандарту ISO 9001;
- При необходимости вся продукция военного и аэрокосмического назначения проходит испытания и сертификацию в лаборатории (по согласованию с заказчиком);
- Поставка специализированных компонентов военного и аэрокосмического уровня качества (Xilinx, Altera, Analog Devices, Intersil, Interpoint, Microsemi, Actel, Aeroflex, Peregrine, VPT, Syfer, Eurofarad, Texas Instruments, MS Kennedy, Miteq, Cobham, E2V, MA-COM, Hittite, Mini-Circuits, General Dynamics и др.);

Компания «Океан Электроники» является официальным дистрибьютором и эксклюзивным представителем в России одного из крупнейших производителей разъемов военного и аэрокосмического назначения «JONHON», а так же официальным дистрибьютором и эксклюзивным представителем в России производителя высокотехнологичных и надежных решений для передачи СВЧ сигналов «FORSTAR».



JONHON

«JONHON» (основан в 1970 г.)

Разъемы специального, военного и аэрокосмического назначения:

(Применяются в военной, авиационной, аэрокосмической, морской, железнодорожной, горно- и нефтедобывающей отраслях промышленности)

«FORSTAR» (основан в 1998 г.)

ВЧ соединители, коаксиальные кабели, кабельные сборки и микроволновые компоненты:

(Применяются в телекоммуникациях гражданского и специального назначения, в средствах связи, РЛС, а так же военной, авиационной и аэрокосмической отраслях промышленности).



Телефон: 8 (812) 309-75-97 (многоканальный)

Факс: 8 (812) 320-03-32

Электронная почта: ocean@oceanchips.ru

Web: <http://oceanchips.ru/>

Адрес: 198099, г. Санкт-Петербург, ул. Калинина, д. 2, корп. 4, лит. А