

# Power Supply Selector Switch IC for SD Cards



## BD2204GUL

### ●Description

BD2204GUL is high side switch IC that has built-in 2 circuits of MOSFET. Switch has achieved 120m $\Omega$  (Typ.) on-resistance. 3.3V power supply and 1.8V power supply for memory card can be selected by SEL terminal. Moreover, it has built-in simultaneous-on prevention function at power switching, reverse-current protection function to prevent reverse-current from output terminal to input terminal at power-off, and discharge circuit to discharge electricity in output terminal.

### ●Features

- Dual channel of low on resistance (Typ. = 120m $\Omega$ ) N-channel MOSFET built in
- 3.3V and 1.8V are chosen and an output is possible.
- 0.5A Continuous Current load
- Reverse-current protection when power switch off
- Prevent VIN1 and VIN2 from simultaneous-on.
- Output Discharge Circuit
- Thermal Shutdown
- Active-High Control Logic
- VCSP50L1 package

### ●Applications

Digital cameras  
Digital video camera  
SD cards slot

### ●Typical Application Circuit

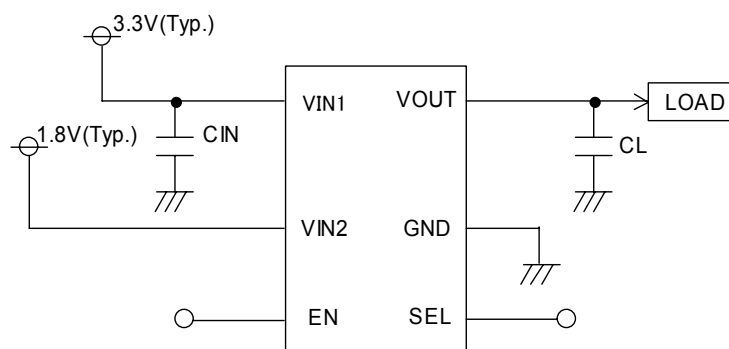

Figure 1. Typical application circuit

### ●Key Specifications

■ Input voltage range:	VIN1=2.7 to 4.5V VIN2=1.2 to 2.4V
■ ON resistance:	120m $\Omega$ (Typ.)
■ Operating current:	25 $\mu$ A(Typ.)
■ Standby current:	0.01 $\mu$ A(Typ.)
■ Operating temperature range:	-40 to +85 $^{\circ}$ C

### ●Package

VCSP50L1

W(Typ.) D(Typ.) H(Max.)  
1.50mm x 1.00mm x 0.55mm

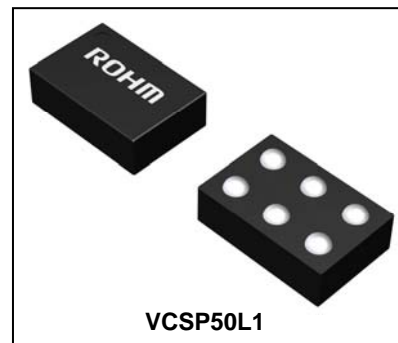

●Block Diagram

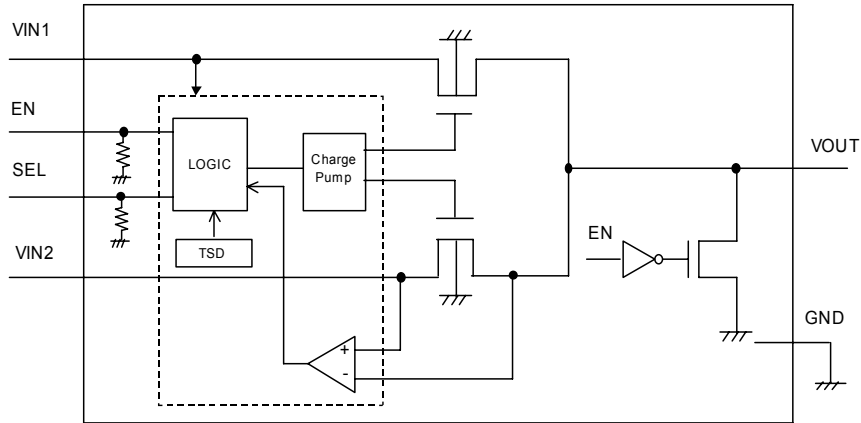

Figure 2. Block Diagram

●Pin Configuration

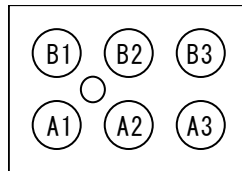

Figure 3. Pin Configuration (BOTTOM VIEW)

●Pin Descriptions

Pin No.	Symbol	I / O	Pin function
A1	VIN1	I	Switch1 input and supply voltage for IC
A2	VIN2	I	Switch2 input
A3	EN	I	Active-high enable input with pull-down resistance (Typ.700Ω)
B1	VOUT	O	Switch output
B2	GND	-	Ground
B3	SEL	I	Output selector input with pull-down resistance (Typ.700Ω) As SEL=L, VOUT=3.3V output, as SEL=H, VOUT=1.8V output

●Absolute Maximum Ratings

Parameter	Symbol	Ratings	Unit
Switch1 input voltage	VIN1	-0.3 to 6.0	V
Switch2 input voltage	VIN2	-0.3 to 6.0	V
EN voltage	VEN	-0.3 to 6.0	V
SEL voltage	VSEL	-0.3 to 6.0	V
VOUT voltage	VOUT	-0.3 to 6.0	V
Output current	IOUT	1.0	A
Storage temperature	TSTG	-55 to 150	°C
Power dissipation	Pd	575 <sup>*1</sup>	mW

\*1 In the case of exceeding Ta = 25°C, 4.6mW should be reduced per 1°C.

### ● Recommended Operating Ratings

Parameter	Symbol	Ratings			Unit
		Min.	Typ.	Max.	
Switch1 input voltage	VIN1	2.7	3.3	4.5	V
Switch2 input voltage	VIN2	1.2	1.8	2.4	V
Operating temperature	TOPR	-40	25	85	°C
Output current	IOUT	-	-	0.5	A

### ● Electrical Characteristics

(VIN1= 3.3V, VIN2= 1.8V, Ta= 25°C, unless otherwise specified.)

Parameter	Symbol	Limits			Unit	Condition
		Min.	Typ.	Max.		
Operating current1	IDD1	-	30	45	μA	VEN = 1.2V, VSEL = 0V VOUT = OPEN
Operating current2	IDD2	-	35	52.5	μA	VEN = VSEL = 1.2V VOUT = OPEN
Standby current	ISTB	-	0.01	1	μA	VEN = 0V, VOUT = OPEN
EN, SEL input voltage	VENH VSELH	1.2	-	-	V	High input
	VENL VSELL	-	-	0.4	V	Low input
EN, SEL input H current	IENH ISELH	2.3	4.7	11.0	μA	VEN = VSEL = 3.3V with pull-down resistance
EN, SEL input L current	IENL ISELL	-1.0	-	1.0	μA	VEN = VSEL = 0V
Pull-down resistance	Rpd	0.3	0.7	1.4	MΩ	Input PIN pull-down resistance
On-resistance1	RON1	-	120	200 <sup>*2</sup>	mΩ	IOUT = 500mA
On-resistance2	RON2	-	120	200 <sup>*2</sup>	mΩ	IOUT = 500mA
Switch leakage current	ILEAK	-	0.01	1	μA	VEN = 0V, VOUT = 0V
Output rise time1	TON1	-	60	300	μs	SEL = L, RL = 10Ω VOUT : 10% → 90%
Output fall time1	TOFF1	-	0.1	1	μs	SEL = L, RL = 10Ω VOUT : 90% → 10%
Output fall time1DISC	TOFF1D	-	300	1000	μs	EN = SEL = L, CL = 1μF VOUT : 90% → 10%
Output rise time2	TON2	-	30	150	μs	SEL = H, RL = 10Ω VOUT : 10% → 90%
Output fall time2	TOFF2	-	0.1	1	μs	SEL = H, RL = 10Ω VOUT : 90% → 10%
Output fall time2DISC	TOFF2D	-	220	1000	μs	EN = L, SEL = H, CL = 1μF VOUT : 90% → 10%
Discharge on-resistance	RDISC	-	80	150	Ω	IOUT = -1mA, VEN = 0V
Discharge current	IDISC	-	10	15	mA	VOUT = 3.3V, VEN = 0V
VOUT drop voltage <sup>*3</sup>	Voutdrop1	-	-	0.4	V	CL = 15μF, IOUT = 500mA VOUT = VIN1 → VIN2
	Voutdrop2	-	-	0.4	V	CL = 15μF, IOUT = 500mA VOUT = VIN2 → VIN1

<sup>\*2</sup> Not 100% tested at the time of shipment.

\*3 When the switch changes from VIN1 to VIN2 or from VIN2 to VIN1, it is possible that VOUT voltage drops. Dropped voltage of VOUT is specified as Voutdrop1 and Voutdrop2. That voltage drop is caused by the function which prevents VIN1 and VIN2 from turning on simultaneously. This function generates the period which both VIN1 and VIN2 are turned off, and prevents the penetration current between VIN1 and VIN2.

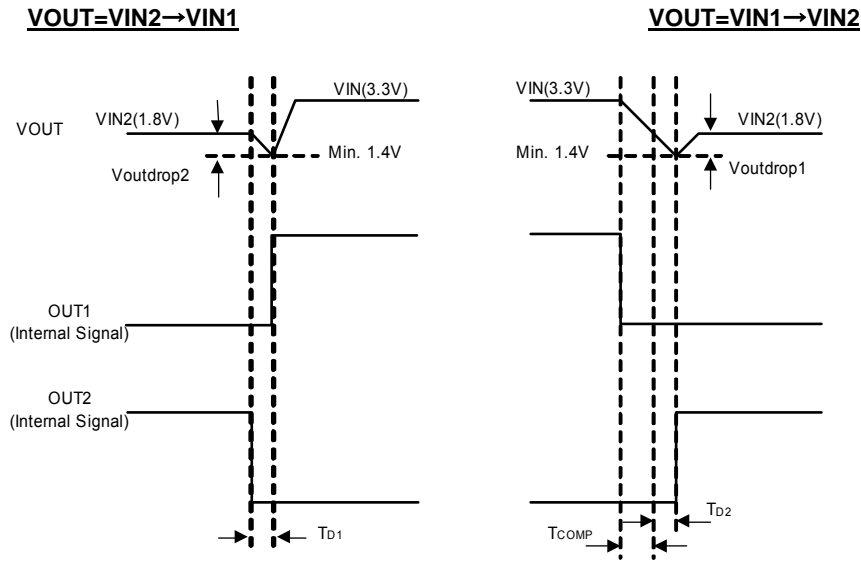

Figure 4. Vout drop voltage

\*TD1 and TD2 + TCOMP are period of Simultaneous-Off.  
 \*TCOMP is period of VOUT becoming same voltage as VIN2.  
 \*The value of Min. is in condition of IOUT=500mA and CL=15uF.

●Measurement Circuit

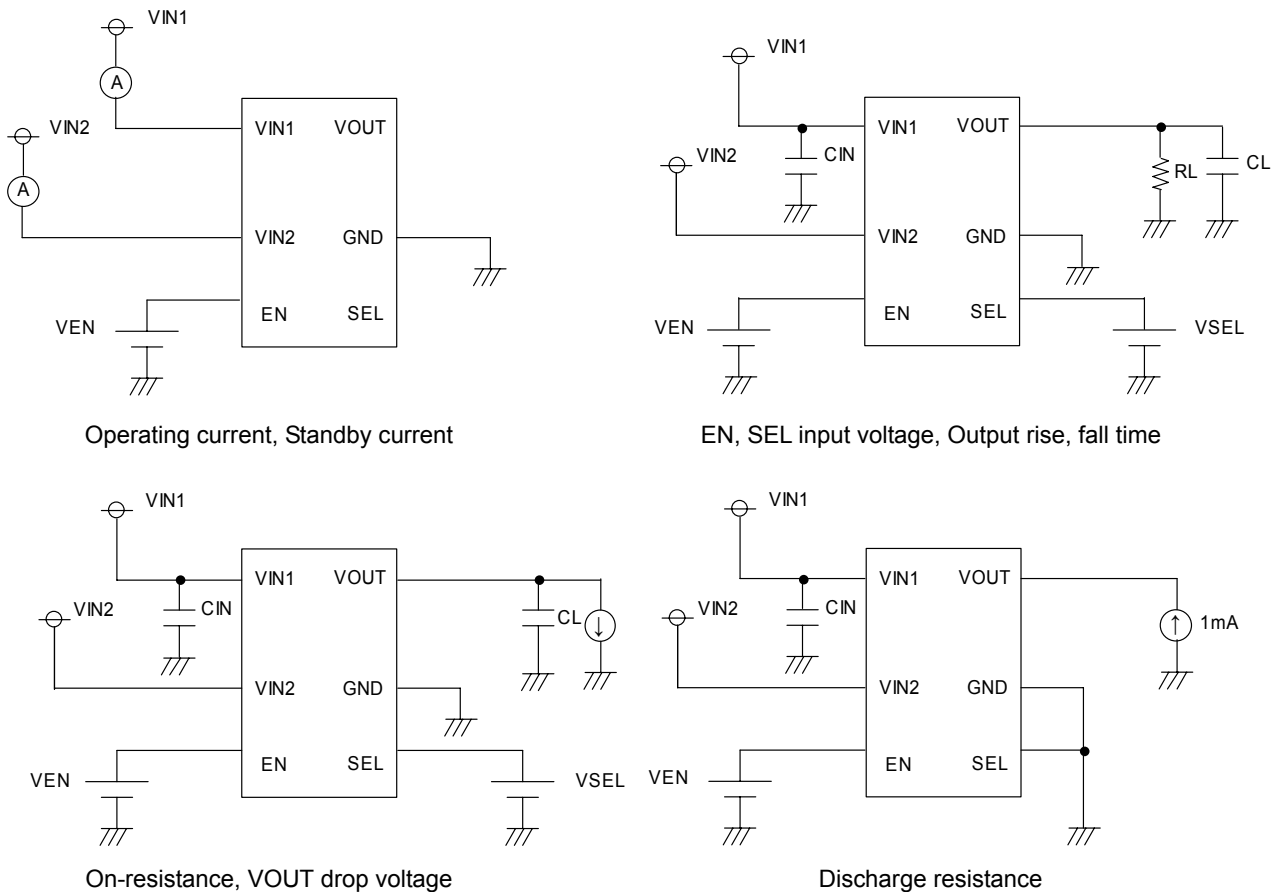

Figure 5. Measurement circuit

● Typical Performance Curves

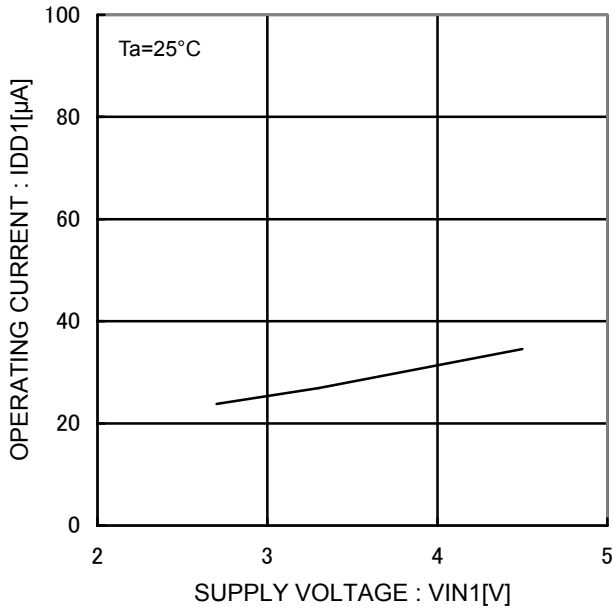

Figure 6. Operating current1  
EN Enable

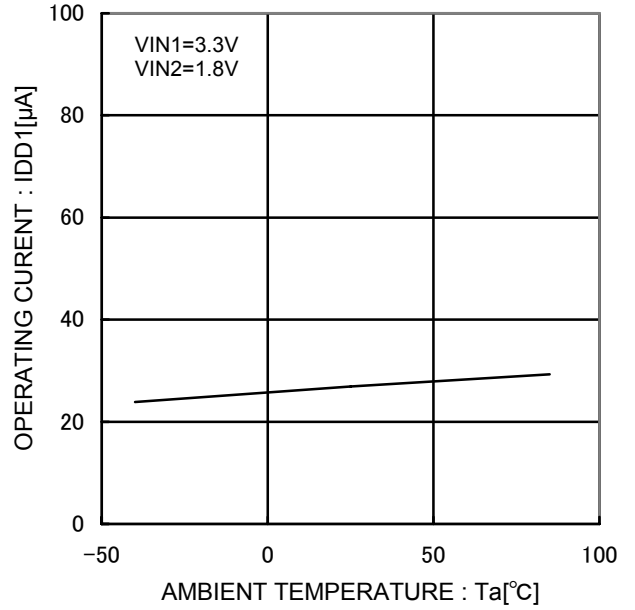

Figure 7. Operating current1  
EN Enable

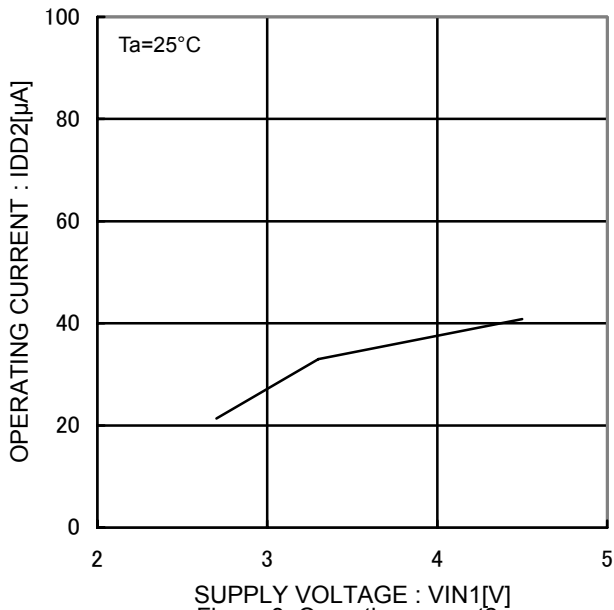

Figure 8. Operating current2  
EN Enable

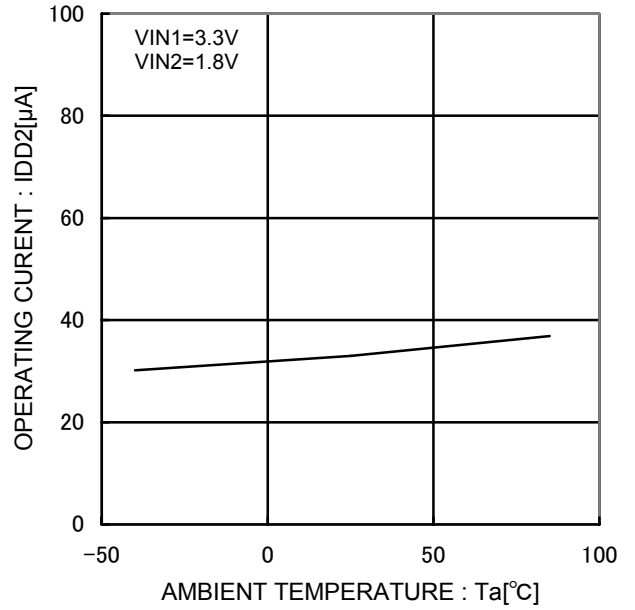
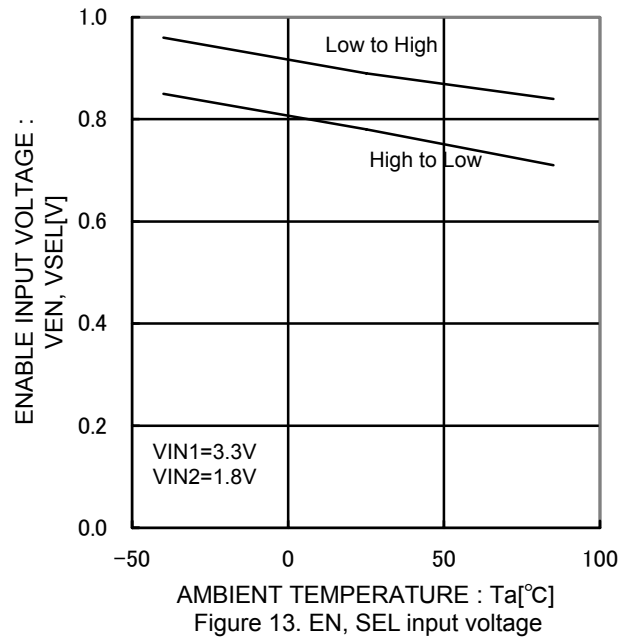
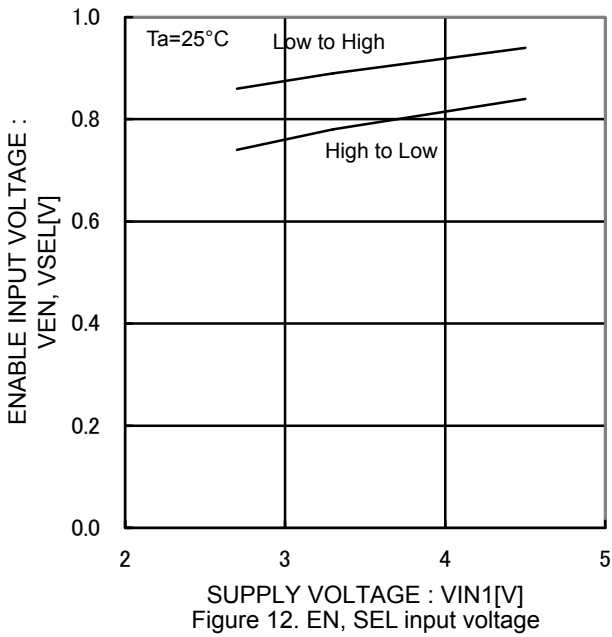
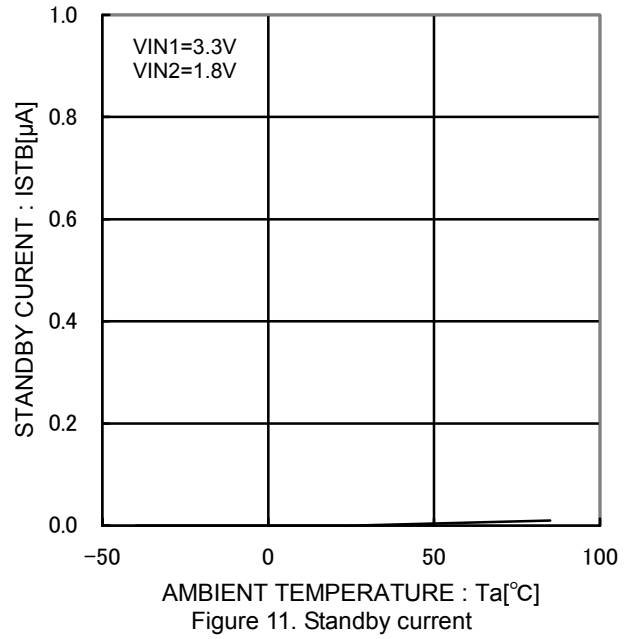
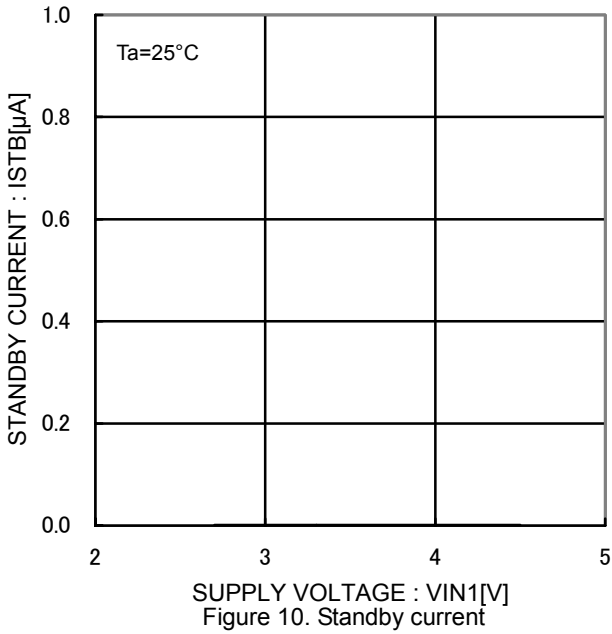
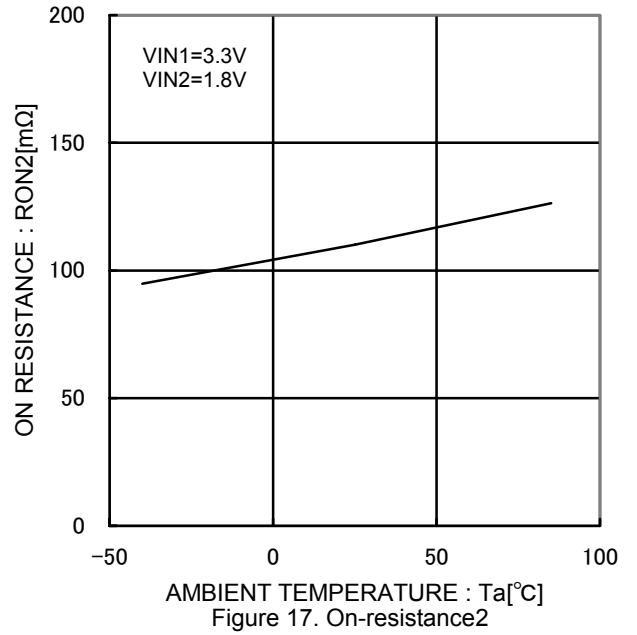
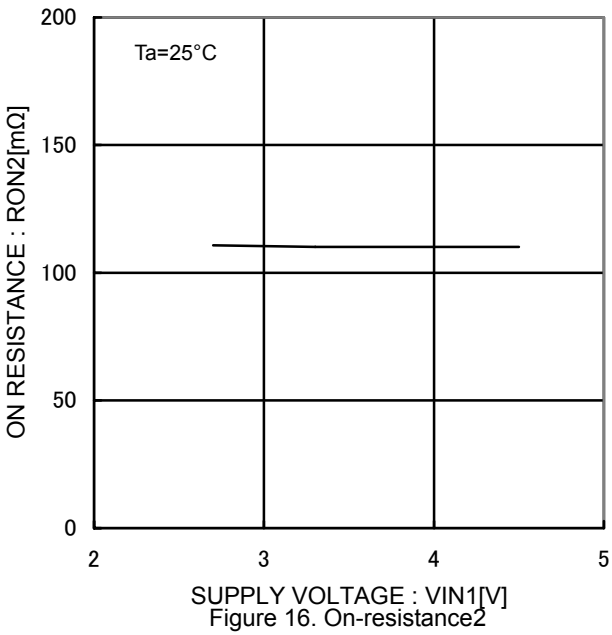
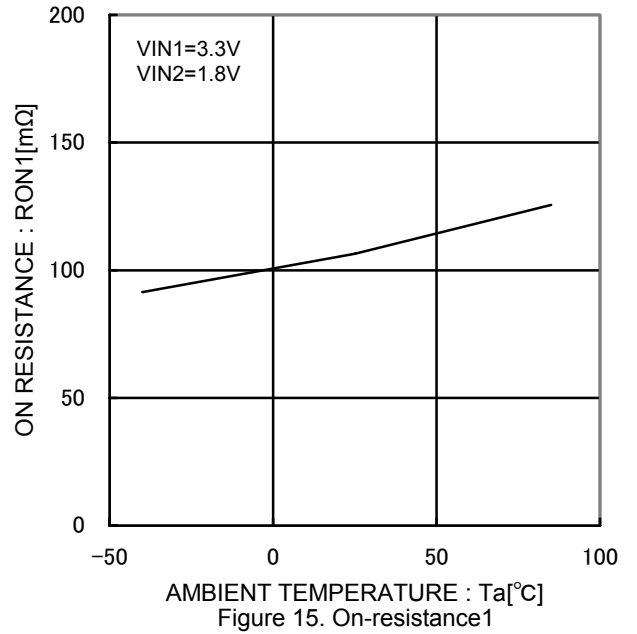
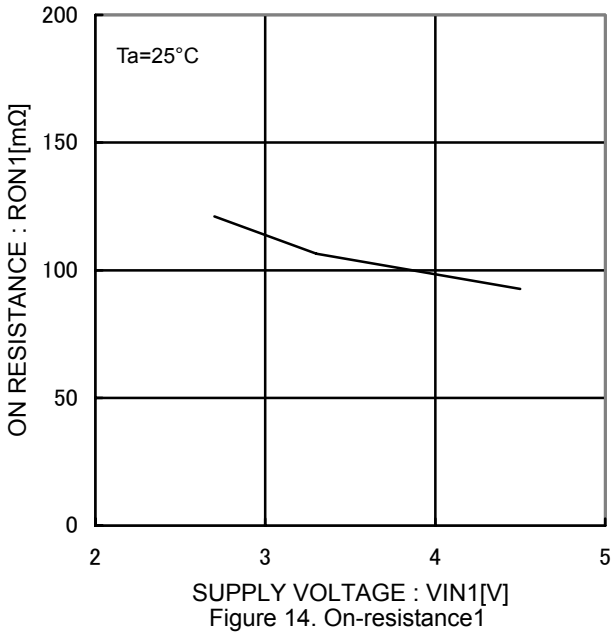

Figure 9. Operating current2  
EN Enable

● Typical Performance Curves - continued



● Typical Performance Curves - continued



● Typical Performance Curves - continued

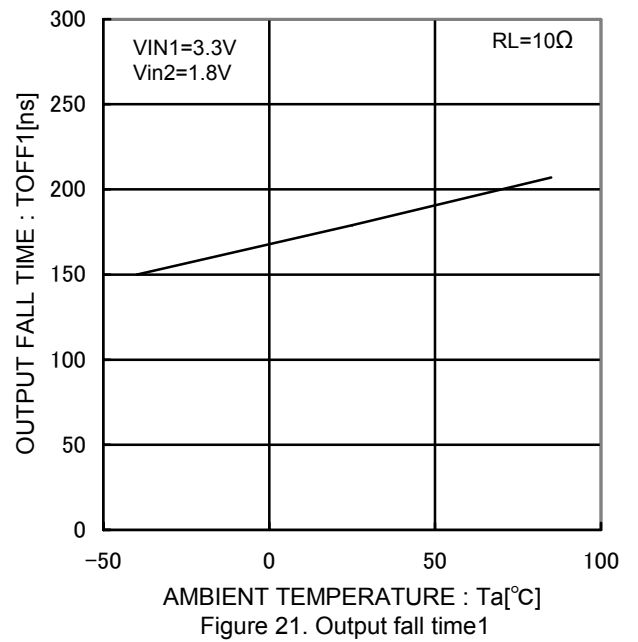
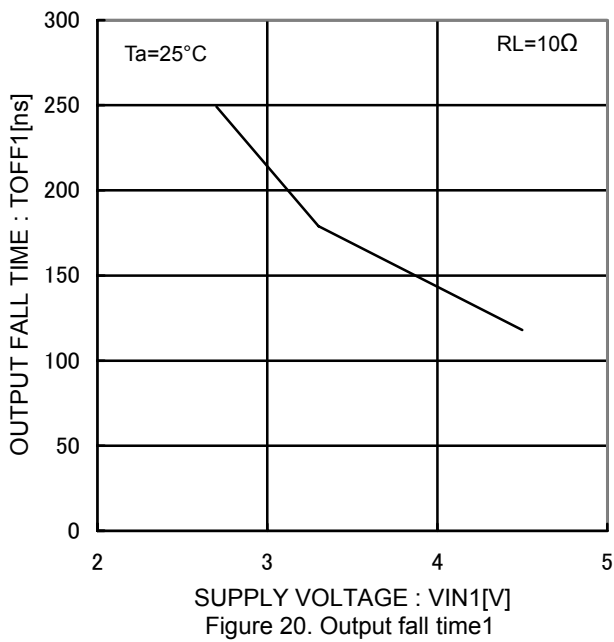
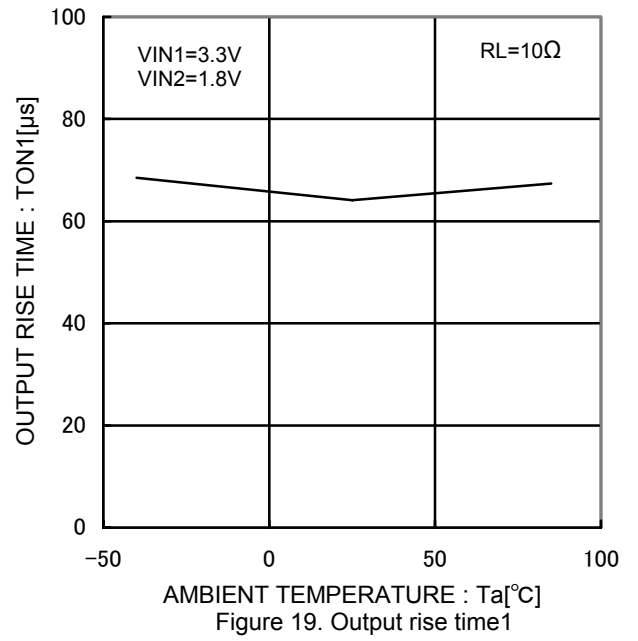
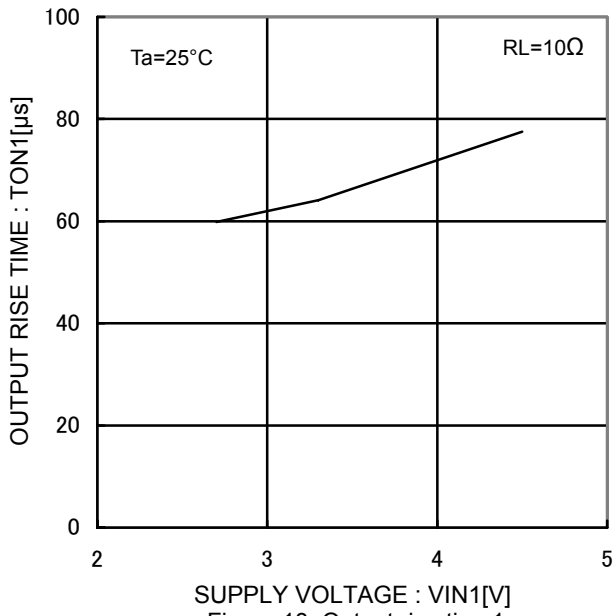



● Typical Performance Curves - continued

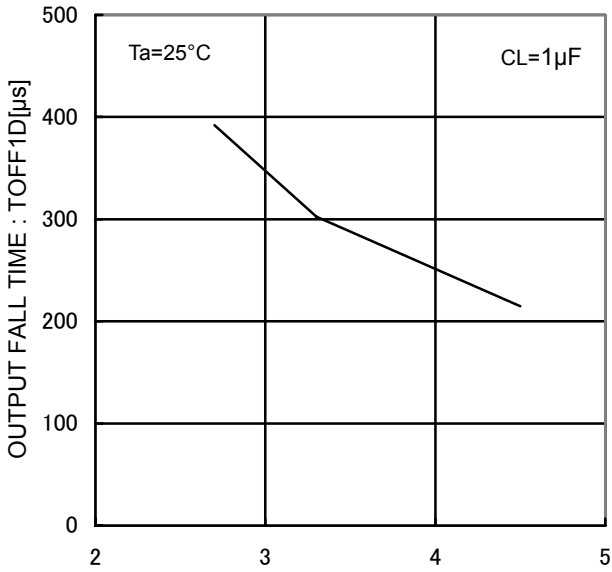

Figure 22. Output fall time1DISC

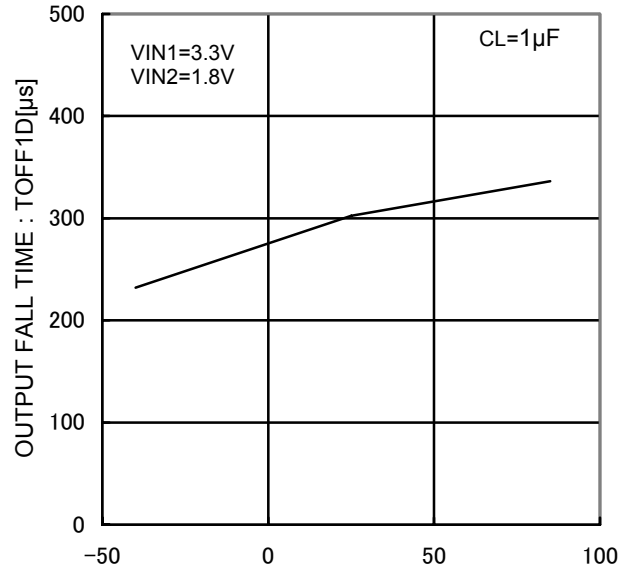

Figure 23. Output fall time1 DISC

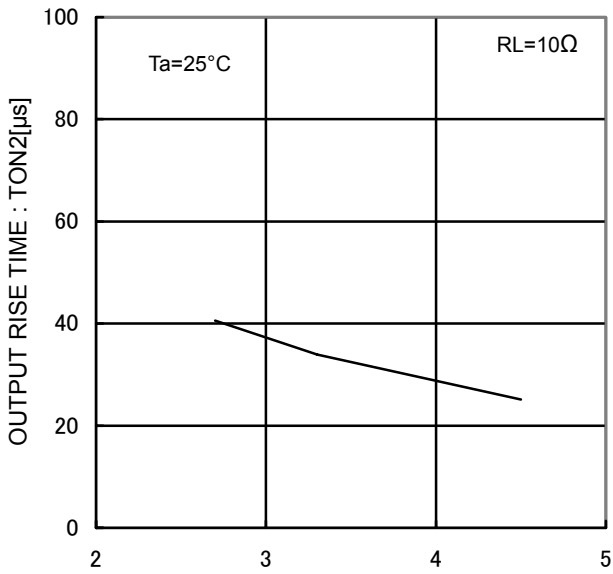

Figure 24. Output rise time2

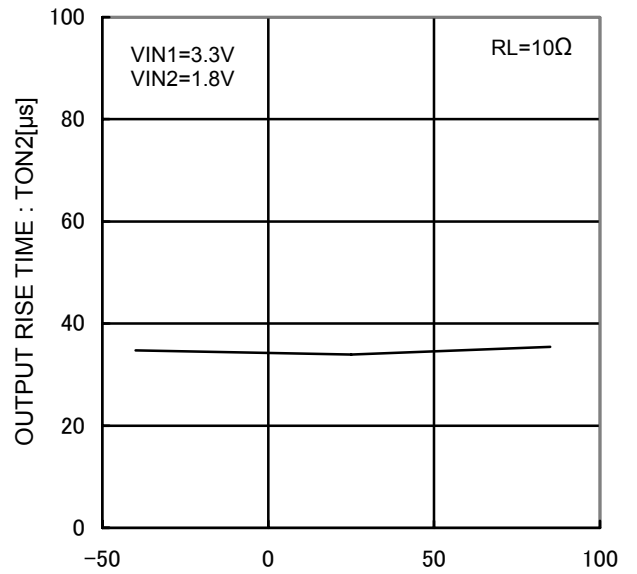
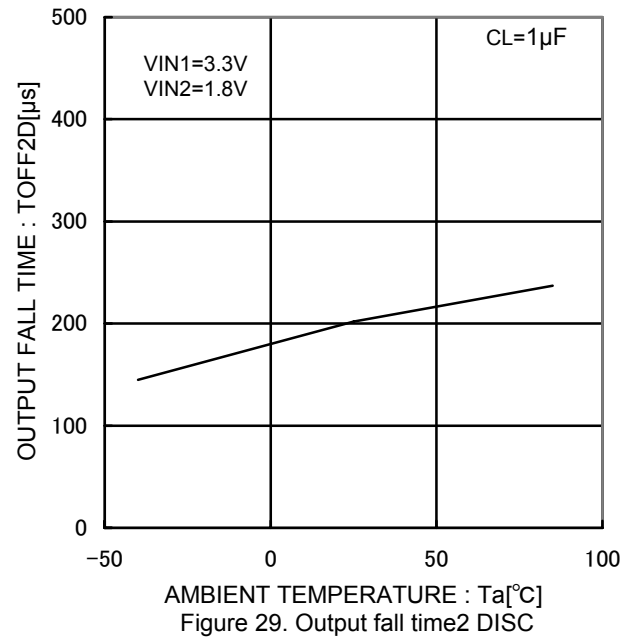
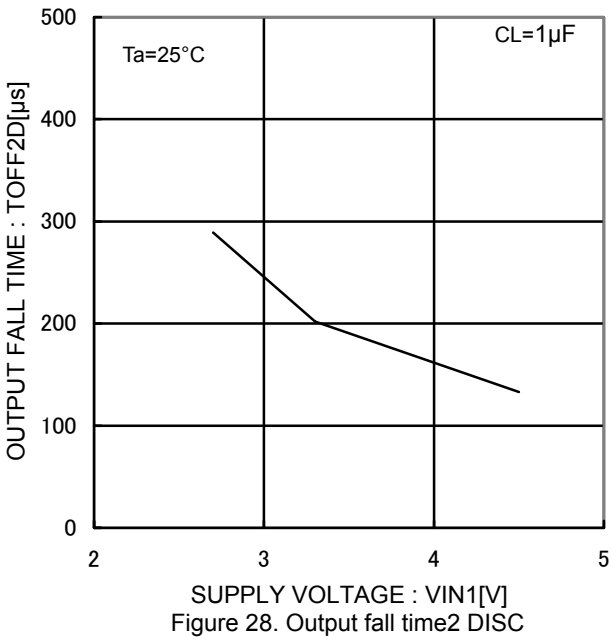
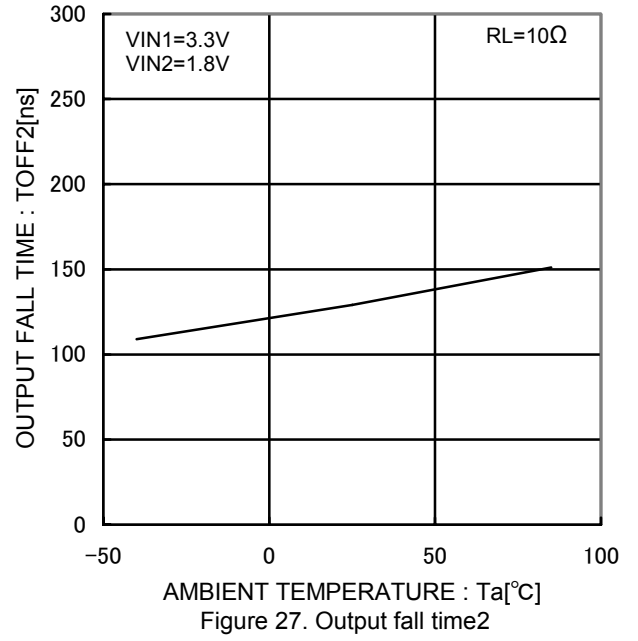
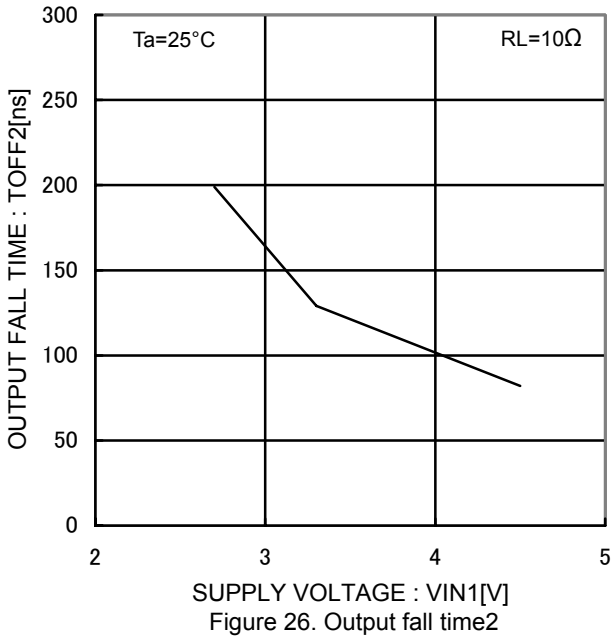
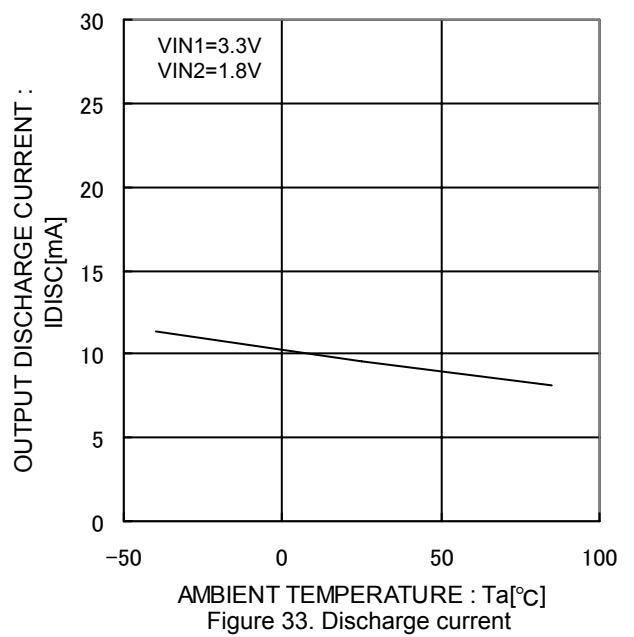
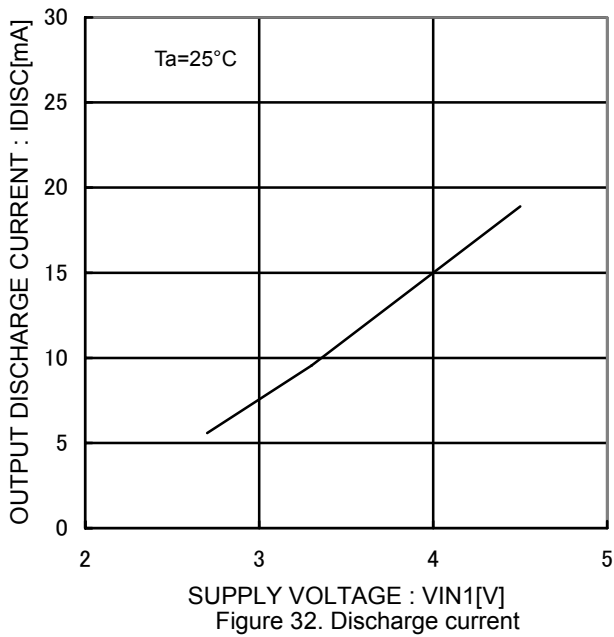
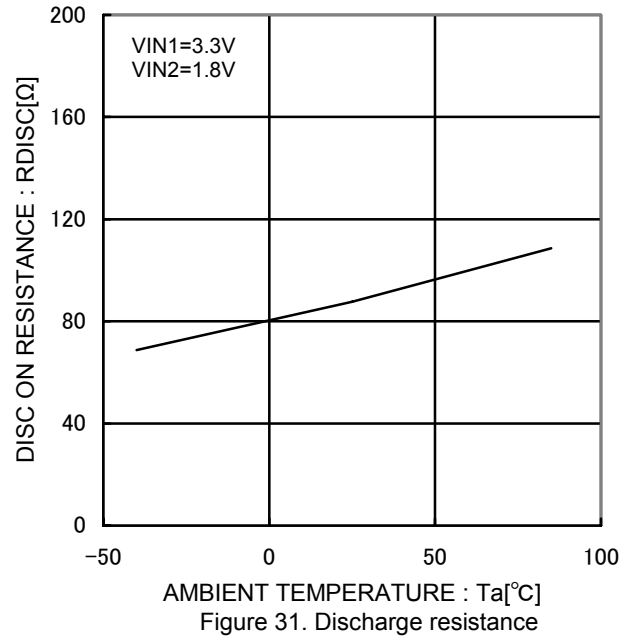
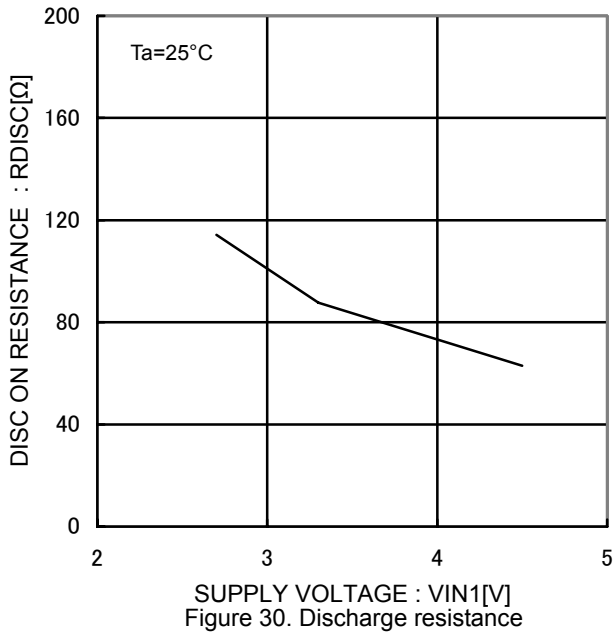

Figure 25. Output rise time2

● Typical Performance Curves - continued



● Typical Performance Curves - continued



● Typical Performance Curves - continued

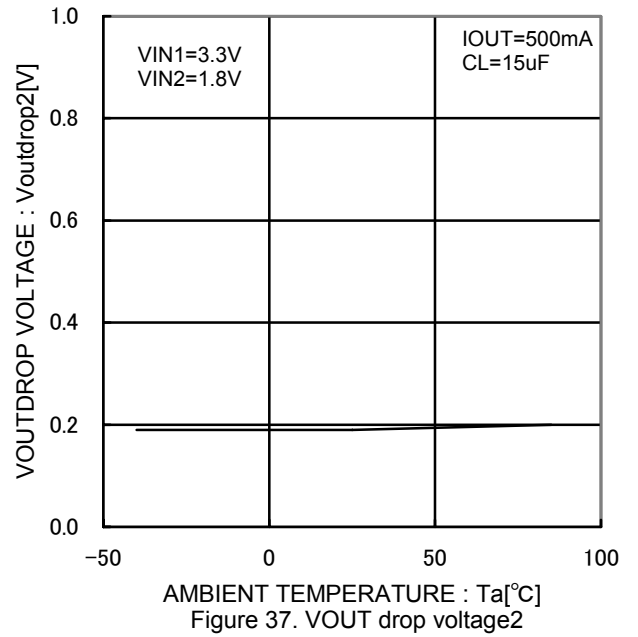
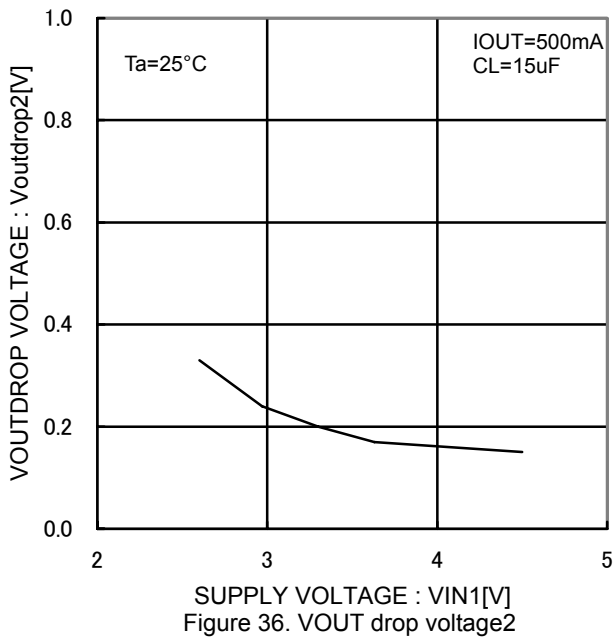
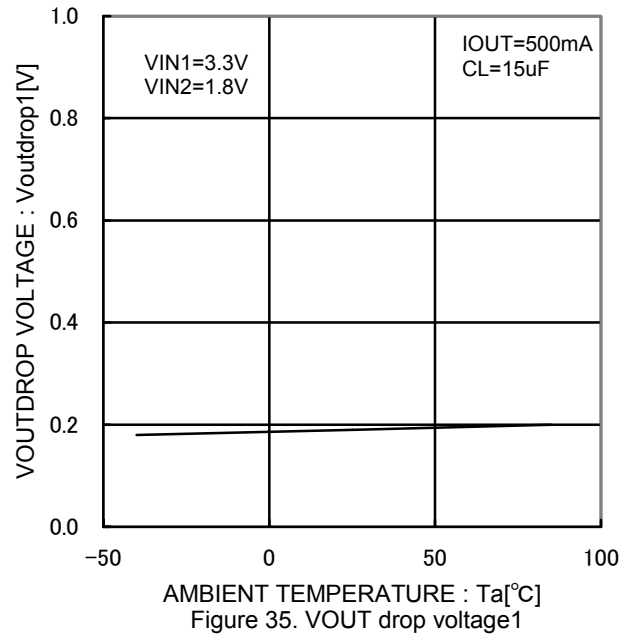
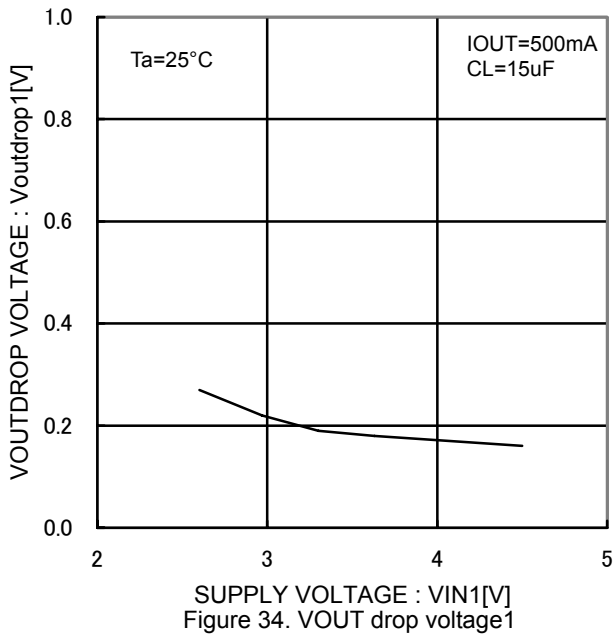

● Typical Performance Curves - continued

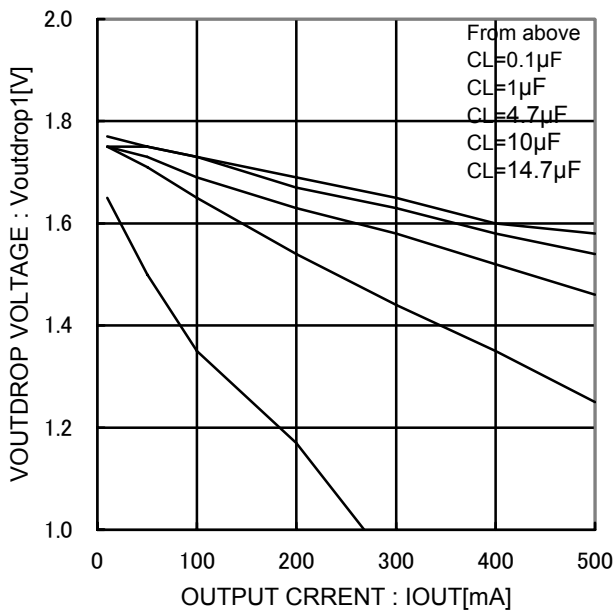

Figure 38. VOUT voltage drop  
 Switch over from VIN1 to VIN2

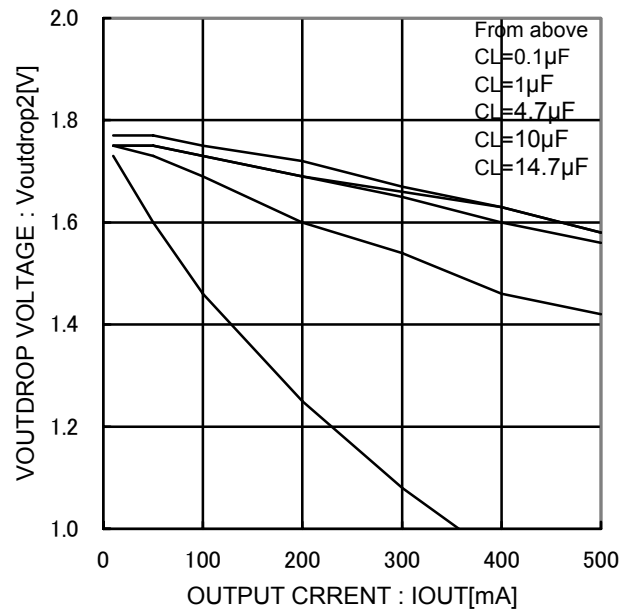

Figure 39. VOUT voltage drop  
 Switch over from VIN2 to VIN1

● Typical Wave Forms

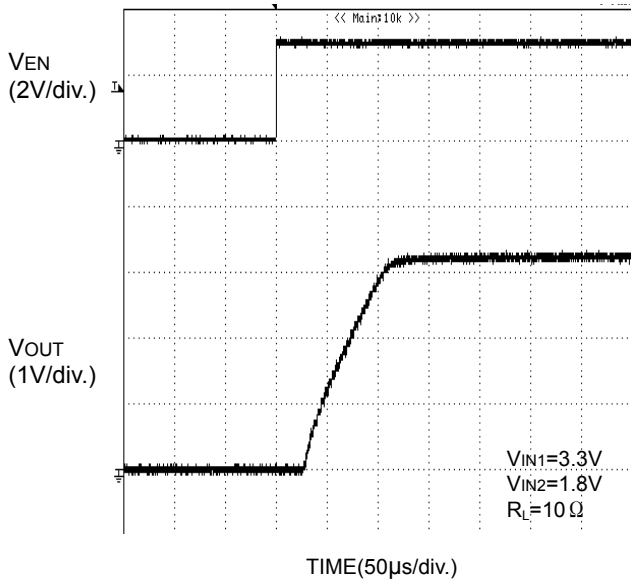

Figure 40. Output rise characteristic  
SEL=L

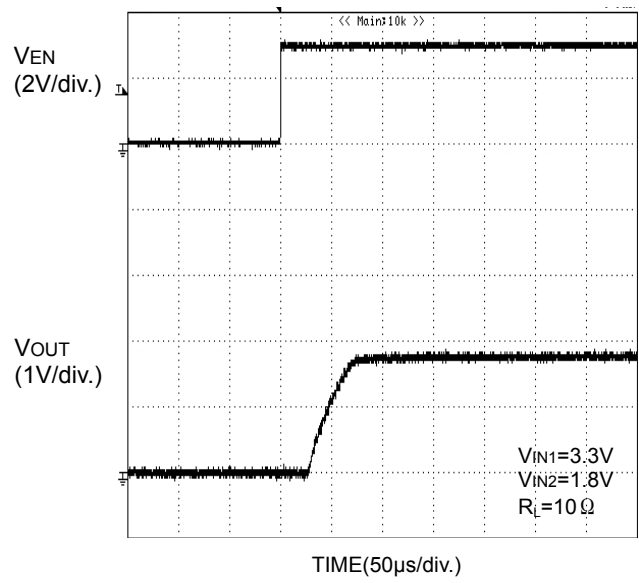

Figure 41. Output rise characteristic  
SEL=H

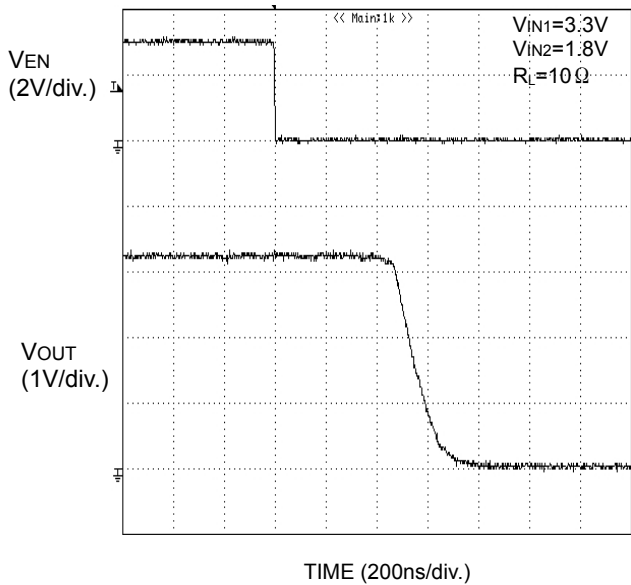

Figure 42. Output fall characteristic  
SEL=L

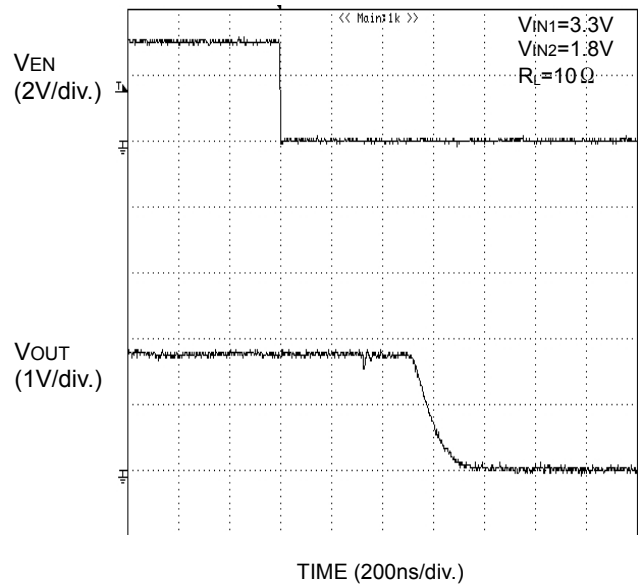

Figure 43. Output fall characteristic  
SEL=H

● Typical Wave Forms - continued

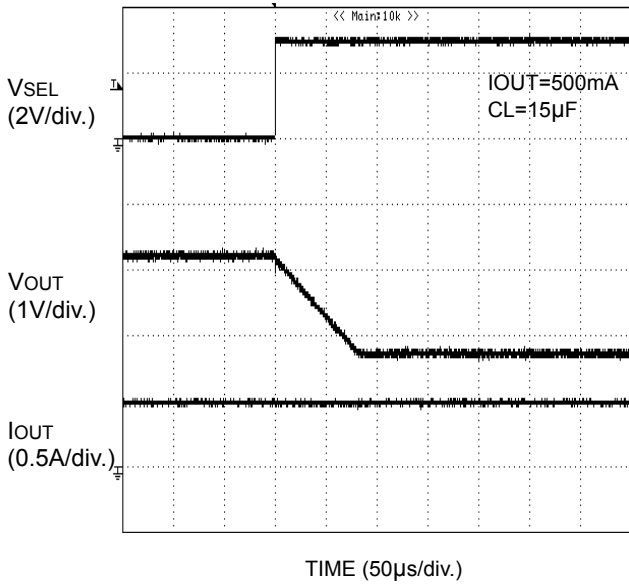

Figure 44. Power switch over characteristic from VIN1 to VIN2

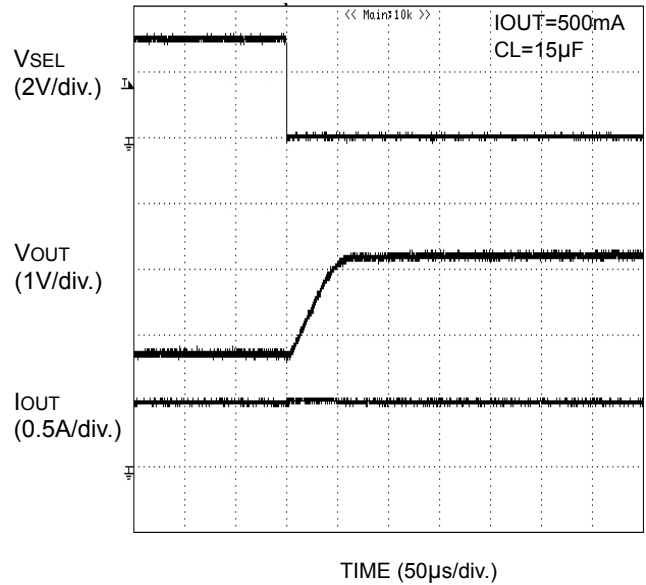

Figure 45. Power switch over characteristic from VIN2 to VIN1

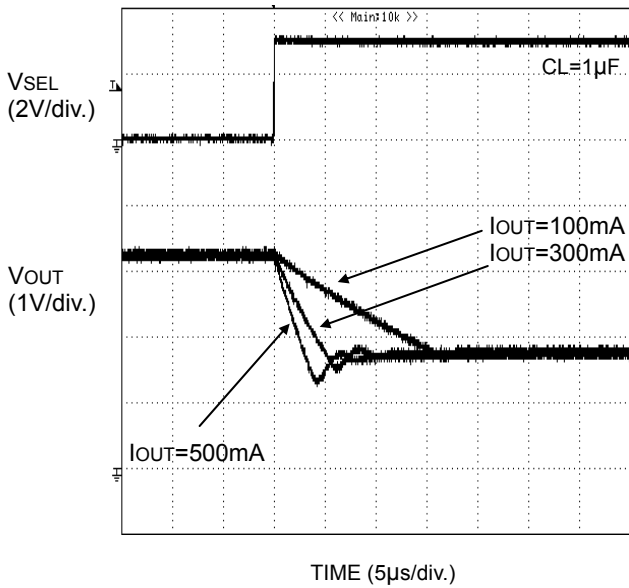

Figure 46. Power switch over characteristic from VIN1 to VIN2

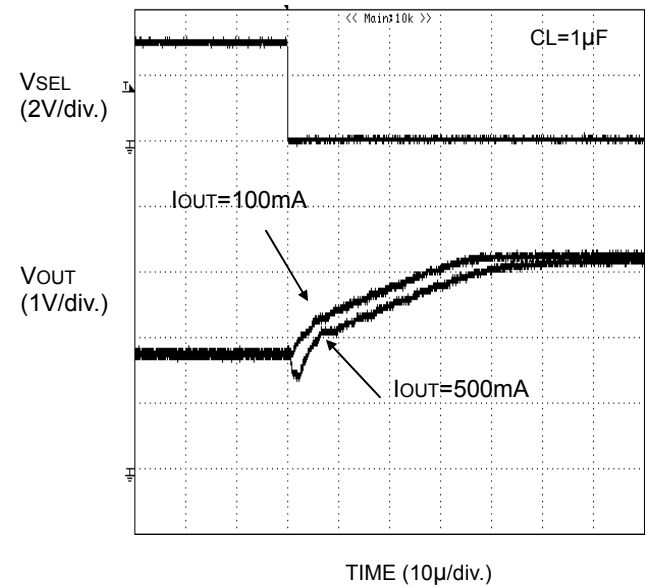

Figure 47. Power switch over characteristic from VIN2 to VIN1

## ●Application Example

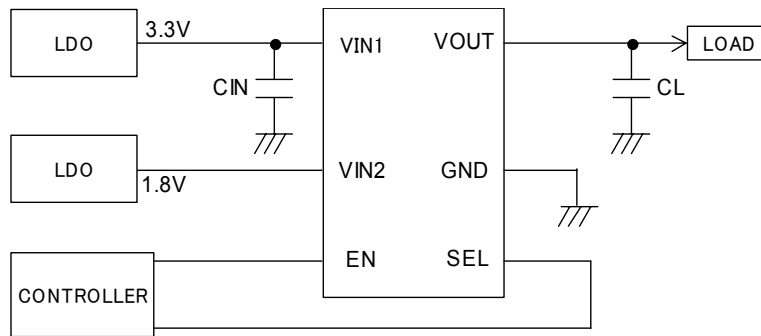

Figure 48. Application circuit example

## ●Application Information

When ringing occurs power source line to IC, and may cause bad influences upon IC actions. In order to avoid this case, connect a bypass capacitor by VIN1 terminal and GND terminal of IC, 0.1 $\mu$ F or higher is recommended.

The switch over time for VOUT drop voltage and power at power switch over varies depending on the load current (IOUT) and the load capacity (CL) of output. Please decide load capacity (CL) suited to load current (IOUT).

This system connection diagram doesn't guarantee operating as the application.

The external circuit constant and so on is changed and it uses, in which there are adequate margins by taking into account external parts or dispersion of IC including not only static characteristics but also transient characteristics.

## ●Functional Description

### 1. Switch operation

VIN1 terminal, VIN2 terminal and VOUT terminal are connected to the drain and the source of switch MOSFET respectively. And the VIN1 terminal is used also as power source input to internal control circuit.

When the switch is turned on from EN control input at SEL=L (SEL=H) input, VIN1 (VIN2) terminal and VOUT terminal are connected by a 120m $\Omega$  switch. In on status, the switch is bi-directional. Therefore, when the potential of VOUT terminal is higher than that of VIN1 (VIN2) terminal, current flows from VOUT terminal to VIN1 (VIN2) terminal.

Since a parasitic diode between the drain and the source of switch MOSFET is canceled, in the off status, it is possible to prevent current from flowing reversely from VOUT to VIN1 (VIN2).

### 2. Switch over operation

When H is input to SEL terminal while VIN1 voltage has been output to VOUT terminal, VIN2 voltage is output to VOUT terminal to prevent current from flowing reversely after detecting that VOUT terminal gets lower than VIN2 voltage. When L is input to SEL terminal while VIN2 voltage has been output to VOUT terminal, VIN1 voltage is output to VOUT terminal immediately.

### 3. Thermal shutdown circuit (TSD)

If over current would continue, the temperature of the IC would increase drastically. If the junction temperature were beyond 135°C (Typ.), thermal shutdown circuit operates and makes power switch turn off. Then, when the junction temperature decreases lower than 115°C (Typ.), power switch is turned on. Unless the fact of the increasing chips temperature is removed or the output of power switch is turned off, this operation repeats.

The thermal shutdown circuit operates when the switch is on (EN signal is active).

### 4. Discharge Circuit

Discharge circuit operates when switch off. When discharge circuit operates, 80 $\Omega$ (Typ.) resistor is connected between VOUT pin and GND pin. This discharges the electrical charge quickly.



●Timing Chart

1) Stand-by → Switch1 ON → Stand-by

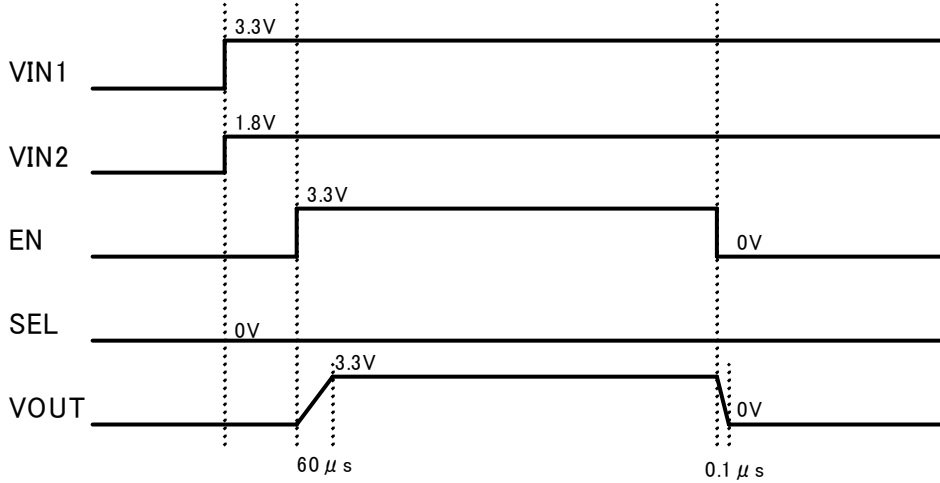

2) Stand-by → VIN1 Output (Switch1 ON) → VIN2 Output (Switch2 ON) → Stand-by

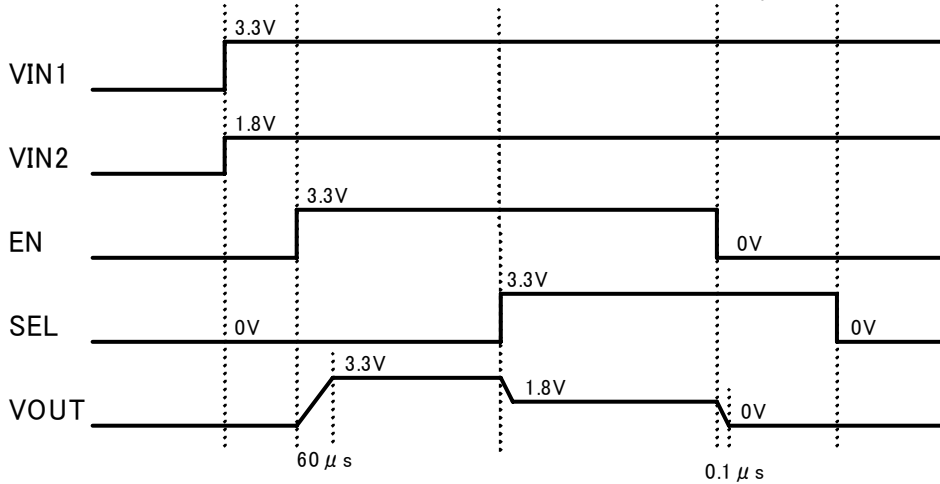

3) Stand-by → VIN2 Output (Switch2 ON) → VIN1 Output (Switch1 ON) → Stand-by

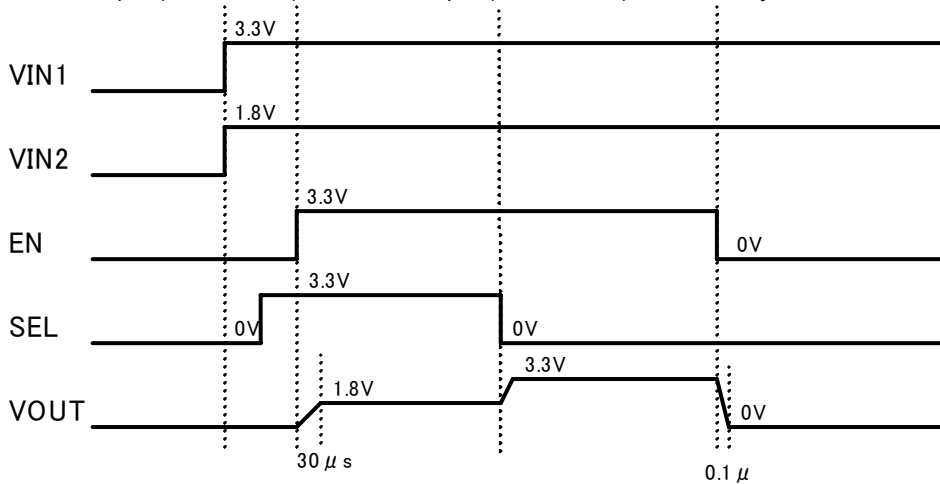
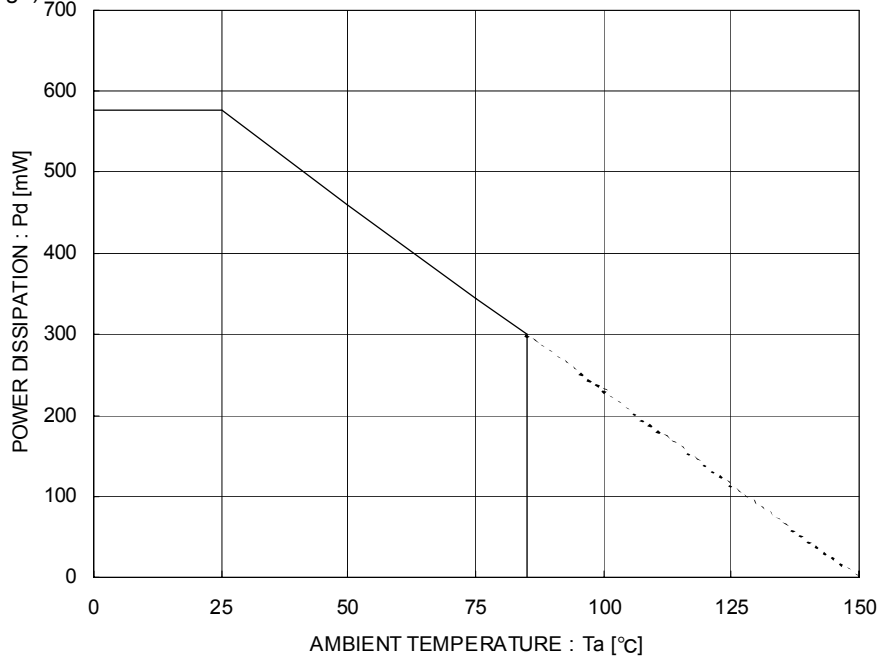

Figure 49. Timing Chart

● Power Dissipation

(VCSP50L1 package)



\* 50mm x 58mm x 1.75mm Glass Epoxy Board

Figure 50. Power dissipation curve (Pd-Ta Curve)

● I/O Equivalence Circuit

Symbol	Pin No	Equivalent circuit
VIN1	A1	
VIN2	A2	
EN, SEL	A3, B3	
VOUT	B1	

**●Operational Notes**

- (1) Absolute Maximum Ratings  
An excess in the absolute maximum ratings, such as supply voltage, temperature range of operating conditions, etc., can break down devices, thus making impossible to identify breaking mode such as a short circuit or an open circuit. If any special mode exceeding the absolute maximum ratings is assumed, consideration should be given to take physical safety measures including the use of fuses, etc.
- (2) Operating conditions  
These conditions represent a range within which characteristics can be provided approximately as expected. The electrical characteristics are guaranteed under the conditions of each parameter.
- (3) Reverse connection of power supply connector  
The reverse connection of power supply connector can break down ICs. Take protective measures against the breakdown due to the reverse connection, such as mounting an external diode between the power supply and the IC's power supply terminal.
- (4) Power supply line  
Design PCB pattern to provide low impedance for the wiring between the power supply and the GND lines. In this regard, for the digital block power supply and the analog block power supply, even though these power supplies has the same level of potential, separate the power supply pattern for the digital block from that for the analog block, thus suppressing the diffraction of digital noises to the analog block power supply resulting from impedance common to the wiring patterns. For the GND line, give consideration to design the patterns in a similar manner.  
Furthermore, for all power supply terminals to ICs, mount a capacitor between the power supply and the GND terminal. At the same time, in order to use an electrolytic capacitor, thoroughly check to be sure the characteristics of the capacitor to be used present no problem including the occurrence of capacity dropout at a low temperature, thus determining the constant.
- (5) GND voltage  
Make setting of the potential of the GND terminal so that it will be maintained at the minimum in any operating state. Furthermore, check to be sure no terminals are at a potential lower than the GND voltage including an actual electric transient.
- (6) Short circuit between terminals and erroneous mounting  
In order to mount ICs on a set PCB, pay thorough attention to the direction and offset of the ICs. Erroneous mounting can break down the ICs. Furthermore, if a short circuit occurs due to foreign matters entering between terminals or between the terminal and the power supply or the GND terminal, the ICs can break down.
- (7) Operation in strong electromagnetic field  
Be noted that using ICs in the strong electromagnetic field can malfunction them.
- (8) Inspection with set PCB  
On the inspection with the set PCB, if a capacitor is connected to a low-impedance IC terminal, the IC can suffer stress. Therefore, be sure to discharge from the set PCB by each process. Furthermore, in order to mount or dismount the set PCB to/from the jig for the inspection process, be sure to turn OFF the power supply and then mount the set PCB to the jig. After the completion of the inspection, be sure to turn OFF the power supply and then dismount it from the jig. In addition, for protection against static electricity, establish a ground for the assembly process and pay thorough attention to the transportation and the storage of the set PCB.
- (9) Input terminals  
In terms of the construction of IC, parasitic elements are inevitably formed in relation to potential. The operation of the parasitic element can cause interference with circuit operation, thus resulting in a malfunction and then breakdown of the input terminal. Therefore, pay thorough attention not to handle the input terminals, such as to apply to the input terminals a voltage lower than the GND respectively, so that any parasitic element will operate. Furthermore, do not apply a voltage to the input terminals when no power supply voltage is applied to the IC. In addition, even if the power supply voltage is applied, apply to the input terminals a voltage lower than the power supply voltage or within the guaranteed value of electrical characteristics.
- (10) Ground wiring pattern  
If small-signal GND and large-current GND are provided, It will be recommended to separate the large-current GND pattern from the small-signal GND pattern and establish a single ground at the reference point of the set PCB so that resistance to the wiring pattern and voltage fluctuations due to a large current will cause no fluctuations in voltages of the small-signal GND. Pay attention not to cause fluctuations in the GND wiring pattern of external parts as well.
- (11) External capacitor  
In order to use a ceramic capacitor as the external capacitor, determine the constant with consideration given to a degradation in the nominal capacitance due to DC bias and changes in the capacitance due to temperature, etc.
- (12) Thermal shutdown circuit (TSD)  
When junction temperatures become detected temperatures or higher, the thermal shutdown circuit operates and turns a switch OFF. The thermal shutdown circuit is aimed at isolating the LSI from thermal runaway as much as possible. Therefore, do not continuously use the LSI with this circuit operating or use the LSI assuming its operation.
- (13) Thermal design  
Perform thermal design in which there are adequate margins by taking into account the power dissipation (Pd) in actual states of use.

●Ordering Information

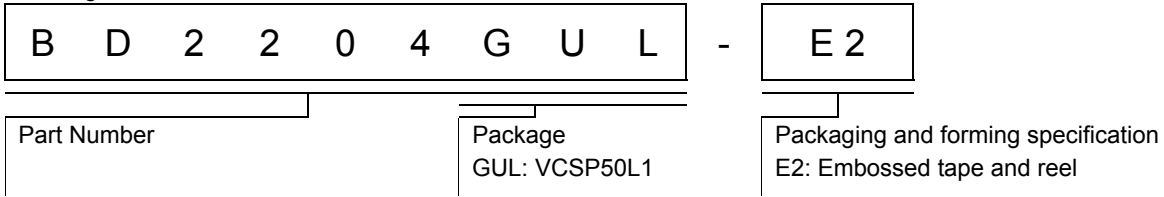

●Physical Dimension Tape and Reel Information

VCSP50L1 (BD2204GUL)

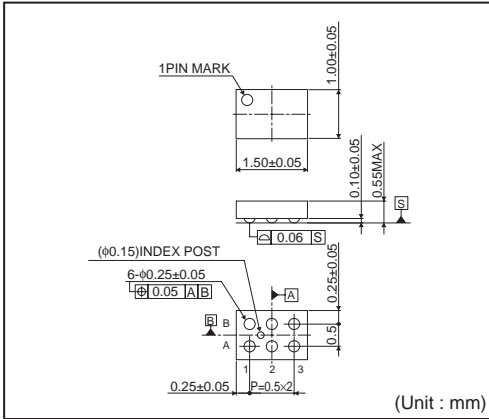

<Tape and Reel information>

Tape	Embossed carrier tape
Quantity	3000pcs
Direction of feed	E2 ( The direction is the 1pin of product is at the upper left when you hold reel on the left hand and you pull out the tape on the right hand )

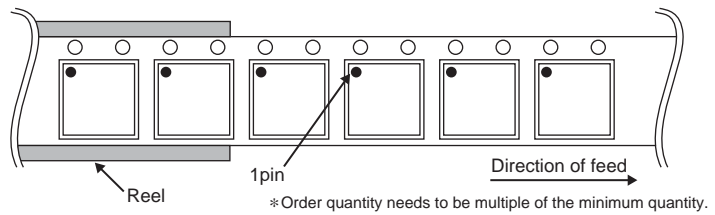

●Marking Diagram

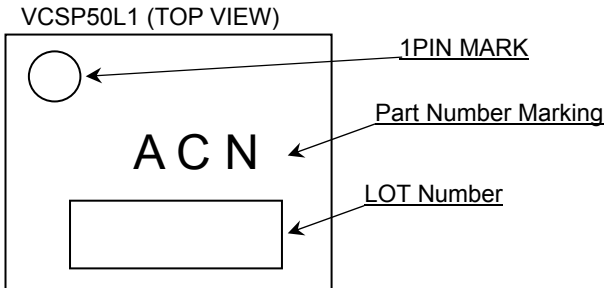

Status of this document

The Japanese version of this document is formal specification. A customer may use this translation version only for a reference to help reading the formal version.

If there are any differences in translation version of this document formal version takes priority.

## ●Revision History

Date	Revision	Changes
07.Aug.2012	001	New Release

# Notice

## ●General Precaution

- 1) Before you use our Products, you are requested to carefully read this document and fully understand its contents. ROHM shall not be in any way responsible or liable for failure, malfunction or accident arising from the use of any ROHM's Products against warning, caution or note contained in this document.
- 2) All information contained in this document is current as of the issuing date and subject to change without any prior notice. Before purchasing or using ROHM's Products, please confirm the latest information with a ROHM sales representative.

## ●Precaution on using ROHM Products

- 1) Our Products are designed and manufactured for application in ordinary electronic equipments (such as AV equipment, OA equipment, telecommunication equipment, home electronic appliances, amusement equipment, etc.). If you intend to use our Products in devices requiring extremely high reliability (such as medical equipment, transport equipment, traffic equipment, aircraft/spacecraft, nuclear power controllers, fuel controllers, car equipment including car accessories, safety devices, etc.) and whose malfunction or failure may cause loss of human life, bodily injury or serious damage to property ("Specific Applications"), please consult with the ROHM sales representative in advance. Unless otherwise agreed in writing by ROHM in advance, ROHM shall not be in any way responsible or liable for any damages, expenses or losses incurred by you or third parties arising from the use of any ROHM's Products for Specific Applications.
- 2) ROHM designs and manufactures its Products subject to strict quality control system. However, semiconductor products can fail or malfunction at a certain rate. Please be sure to implement, at your own responsibilities, adequate safety measures including but not limited to fail-safe design against the physical injury, damage to any property, which a failure or malfunction of our Products may cause. The following are examples of safety measures:
  - [a] Installation of protection circuits or other protective devices to improve system safety
  - [b] Installation of redundant circuits to reduce the impact of single or multiple circuit failure
- 3) Our Products are designed and manufactured for use under standard conditions and not under any special or extraordinary environments or conditions, as exemplified below. Accordingly, ROHM shall not be in any way responsible or liable for any damages, expenses or losses arising from the use of any ROHM's Products under any special or extraordinary environments or conditions. If you intend to use our Products under any special or extraordinary environments or conditions (as exemplified below), your independent verification and confirmation of product performance, reliability, etc. prior to use, must be necessary:
  - [a] Use of our Products in any types of liquid, including water, oils, chemicals, and organic solvents
  - [b] Use of our Products outdoors or in places where the Products are exposed to direct sunlight or dust
  - [c] Use of our Products in places where the Products are exposed to sea wind or corrosive gases, including Cl<sub>2</sub>, H<sub>2</sub>S, NH<sub>3</sub>, SO<sub>2</sub>, and NO<sub>2</sub>
  - [d] Use of our Products in places where the Products are exposed to static electricity or electromagnetic waves
  - [e] Use of our Products in proximity to heat-producing components, plastic cords, or other flammable items
  - [f] Sealing or coating our Products with resin or other coating materials
  - [g] Use of our Products without cleaning residue of flux (even if you use no-clean type fluxes, cleaning residue of flux is recommended); or Washing our Products by using water or water-soluble cleaning agents for cleaning residue after soldering
  - [h] Use of the Products in places subject to dew condensation
- 4) The Products are not subject to radiation-proof design.
- 5) Please verify and confirm characteristics of the final or mounted products in using the Products.
- 6) In particular, if a transient load (a large amount of load applied in a short period of time, such as pulse) is applied, confirmation of performance characteristics after on-board mounting is strongly recommended. Avoid applying power exceeding normal rated power; exceeding the power rating under steady-state loading condition may negatively affect product performance and reliability.
- 7) De-rate Power Dissipation (Pd) depending on Ambient temperature (Ta). When used in sealed area, confirm the actual ambient temperature.
- 8) Confirm that operation temperature is within the specified range described in the product specification.
- 9) ROHM shall not be in any way responsible or liable for failure induced under deviant condition from what is defined in this document.

● **Precaution for Mounting / Circuit board design**

- 1) When a highly active halogenous (chlorine, bromine, etc.) flux is used, the residue of flux may negatively affect product performance and reliability.
- 2) In principle, the reflow soldering method must be used; if flow soldering method is preferred, please consult with the ROHM representative in advance.

For details, please refer to ROHM Mounting specification

● **Precautions Regarding Application Examples and External Circuits**

- 1) If change is made to the constant of an external circuit, please allow a sufficient margin considering variations of the characteristics of the Products and external components, including transient characteristics, as well as static characteristics.
- 2) You agree that application notes, reference designs, and associated data and information contained in this document are presented only as guidance for Products use. Therefore, in case you use such information, you are solely responsible for it and you must exercise your own independent verification and judgment in the use of such information contained in this document. ROHM shall not be in any way responsible or liable for any damages, expenses or losses incurred by you or third parties arising from the use of such information.

● **Precaution for Electrostatic**

This Product is electrostatic sensitive product, which may be damaged due to electrostatic discharge. Please take proper caution in your manufacturing process and storage so that voltage exceeding the Products maximum rating will not be applied to Products. Please take special care under dry condition (e.g. Grounding of human body / equipment / solder iron, isolation from charged objects, setting of Ionizer, friction prevention and temperature / humidity control).

● **Precaution for Storage / Transportation**

- 1) Product performance and soldered connections may deteriorate if the Products are stored in the places where:
  - [a] the Products are exposed to sea winds or corrosive gases, including Cl<sub>2</sub>, H<sub>2</sub>S, NH<sub>3</sub>, SO<sub>2</sub>, and NO<sub>2</sub>
  - [b] the temperature or humidity exceeds those recommended by ROHM
  - [c] the Products are exposed to direct sunshine or condensation
  - [d] the Products are exposed to high Electrostatic
- 2) Even under ROHM recommended storage condition, solderability of products out of recommended storage time period may be degraded. It is strongly recommended to confirm solderability before using Products of which storage time is exceeding the recommended storage time period.
- 3) Store / transport cartons in the correct direction, which is indicated on a carton with a symbol. Otherwise bent leads may occur due to excessive stress applied when dropping of a carton.
- 4) Use Products within the specified time after opening a humidity barrier bag. Baking is required before using Products of which storage time is exceeding the recommended storage time period.

● **Precaution for Product Label**

QR code printed on ROHM Products label is for ROHM's internal use only.

● **Precaution for Disposition**

When disposing Products please dispose them properly using an authorized industry waste company.

● **Precaution for Foreign Exchange and Foreign Trade act**

Since our Products might fall under controlled goods prescribed by the applicable foreign exchange and foreign trade act, please consult with ROHM representative in case of export.

● **Precaution Regarding Intellectual Property Rights**

- 1) All information and data including but not limited to application example contained in this document is for reference only. ROHM does not warrant that foregoing information or data will not infringe any intellectual property rights or any other rights of any third party regarding such information or data. ROHM shall not be in any way responsible or liable for infringement of any intellectual property rights or other damages arising from use of such information or data.:
- 2) No license, expressly or implied, is granted hereby under any intellectual property rights or other rights of ROHM or any third parties with respect to the information contained in this document.

### ●Other Precaution

- 1) The information contained in this document is provided on an “as is” basis and ROHM does not warrant that all information contained in this document is accurate and/or error-free. ROHM shall not be in any way responsible or liable for any damages, expenses or losses incurred by you or third parties resulting from inaccuracy or errors of or concerning such information.
- 2) This document may not be reprinted or reproduced, in whole or in part, without prior written consent of ROHM.
- 3) The Products may not be disassembled, converted, modified, reproduced or otherwise changed without prior written consent of ROHM.
- 4) In no event shall you use in any way whatsoever the Products and the related technical information contained in the Products or this document for any military purposes, including but not limited to, the development of mass-destruction weapons.
- 5) The proper names of companies or products described in this document are trademarks or registered trademarks of ROHM, its affiliated companies or third parties.





Компания «Океан Электроники» предлагает заключение долгосрочных отношений при поставках импортных электронных компонентов на взаимовыгодных условиях!

Наши преимущества:

- Поставка оригинальных импортных электронных компонентов напрямую с производств Америки, Европы и Азии, а так же с крупнейших складов мира;
- Широкая линейка поставок активных и пассивных импортных электронных компонентов (более 30 млн. наименований);
- Поставка сложных, дефицитных, либо снятых с производства позиций;
- Оперативные сроки поставки под заказ (от 5 рабочих дней);
- Экспресс доставка в любую точку России;
- Помощь Конструкторского Отдела и консультации квалифицированных инженеров;
- Техническая поддержка проекта, помощь в подборе аналогов, поставка прототипов;
- Поставка электронных компонентов под контролем ВП;
- Система менеджмента качества сертифицирована по Международному стандарту ISO 9001;
- При необходимости вся продукция военного и аэрокосмического назначения проходит испытания и сертификацию в лаборатории (по согласованию с заказчиком);
- Поставка специализированных компонентов военного и аэрокосмического уровня качества (Xilinx, Altera, Analog Devices, Intersil, Interpoint, Microsemi, Actel, Aeroflex, Peregrine, VPT, Syfer, Eurofarad, Texas Instruments, MS Kennedy, Miteq, Cobham, E2V, MA-COM, Hittite, Mini-Circuits, General Dynamics и др.);

Компания «Океан Электроники» является официальным дистрибьютором и эксклюзивным представителем в России одного из крупнейших производителей разъемов военного и аэрокосмического назначения «JONHON», а так же официальным дистрибьютором и эксклюзивным представителем в России производителя высокотехнологичных и надежных решений для передачи СВЧ сигналов «FORSTAR».



## JONHON

«JONHON» (основан в 1970 г.)

Разъемы специального, военного и аэрокосмического назначения:

(Применяются в военной, авиационной, аэрокосмической, морской, железнодорожной, горно- и нефтедобывающей отраслях промышленности)

«FORSTAR» (основан в 1998 г.)

ВЧ соединители, коаксиальные кабели, кабельные сборки и микроволновые компоненты:

(Применяются в телекоммуникациях гражданского и специального назначения, в средствах связи, РЛС, а так же военной, авиационной и аэрокосмической отраслях промышленности).



Телефон: 8 (812) 309-75-97 (многоканальный)

Факс: 8 (812) 320-03-32

Электронная почта: [ocean@oceanchips.ru](mailto:ocean@oceanchips.ru)

Web: <http://oceanchips.ru/>

Адрес: 198099, г. Санкт-Петербург, ул. Калинина, д. 2, корп. 4, лит. А