

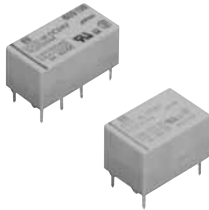

High Reliability Relay for Various Applications

DS RELAYS



FEATURES

- 1. Breakthrough height of 9.8 mm .386 inch beats the 10 mm .394 inch limit**
1c and 2c all have the same height (9.8 mm .386 inch). The width of the relay is also the same (9.9 mm .390 inch). Since the only size variable is the length, the shared form makes mounting on printed printing wiring boards easy.
- 2. Suitable for use in difficult environments**
Epoxy resin seals the parts and cut off the external atmosphere, thus enabling use in difficult environments.
- 3. Can be used with automatic solder and automatic wash systems**
Automatic soldering and automatic washing can be carried out once the parts are mounted on PC boards.
- 4. Gold-clad twin contacts ensure high reliability**
Highly stable gold cladding on the contacts ensures that contact resistance changes little over time. Furthermore, the use of twin contacts, a configuration that performs with superior contact reliability, ensures extremely low contact failure rates even under low level loads.

- 5. Polarized magnetic circuits realize resistance to shock and vibration**
High-performance polarized magnetic circuits that utilize the energy of permanent magnets have made it possible to create relays with strong resistance to shock and vibration.
- 6. DIL terminal array enables use of IC sockets**
- 7. Widening scope of application with multicontact latching**
In addition to single side stable types, you can take advantage of the memory of functions of convenient 2 coil latching relays.

TYPICAL APPLICATIONS

Besides telecommunications, measuring devices, office equipment, computers and related equipment, DS relays are also recommended for a broad range of applications including business devices, audio systems, and industrial equipment.

RoHS compliant

ORDERING INFORMATION

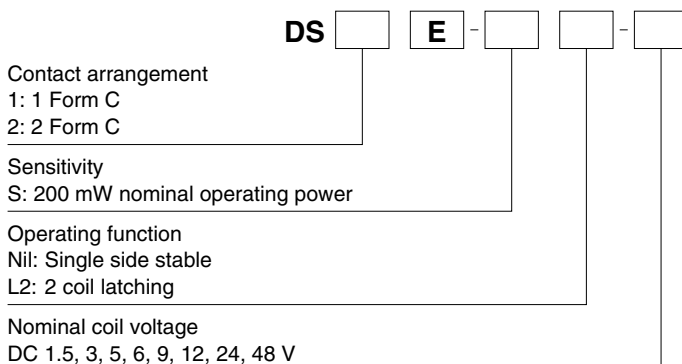

Note: * Nominal coil voltage 1.5V type are 1 Form C only.

TYPES

1. High sensitivity type

Contact arrangement	Nominal coil voltage	Single side stable type	2 coil latching type
		Part No.	Part No.
1 Form C	1.5V DC	DS1E-S-DC1.5V	DS1E-SL2-DC1.5V
	3V DC	DS1E-S-DC3V	DS1E-SL2-DC3V
	5V DC	DS1E-S-DC5V	DS1E-SL2-DC5V
	6V DC	DS1E-S-DC6V	DS1E-SL2-DC6V
	9V DC	DS1E-S-DC9V	DS1E-SL2-DC9V
	12V DC	DS1E-S-DC12V	DS1E-SL2-DC12V
	24V DC	DS1E-S-DC24V	DS1E-SL2-DC24V
2 Form C	48V DC	DS1E-S-DC48V	DS1E-SL2-DC48V
	3V DC	DS2E-S-DC3V	DS2E-SL2-DC3V
	5V DC	DS2E-S-DC5V	DS2E-SL2-DC5V
	6V DC	DS2E-S-DC6V	DS2E-SL2-DC6V
	9V DC	DS2E-S-DC9V	DS2E-SL2-DC9V
	12V DC	DS2E-S-DC12V	DS2E-SL2-DC12V
	24V DC	DS2E-S-DC24V	DS2E-SL2-DC24V
48V DC	DS2E-S-DC48V	DS2E-SL2-DC48V	

Standard packing: Carton: 50 pcs.; Case: 500 pcs.

RATING

1. Coil data

1) Single side stable type

Type	Nominal coil voltage	Pick-up voltage (at 20°C 68°F)	Drop-out voltage (at 20°C 68°F)	Nominal operating current [$\pm 10\%$] (at 20°C 68°F)	Coil resistance [$\pm 10\%$] (at 20°C 68°F)	Nominal operating power	Max. applied voltage (at 50°C 122°F)
High sensitivity (S) type	1.5V DC*	1 Form C: 80%V or less of nominal voltage 2 Form C: 70%V or less of nominal voltage (Initial)	10%V or more of nominal voltage (Initial)	133.3mA	11.3 Ω	200mW	1 Form C: 160%V of nominal voltage 2 Form C: 200%V of nominal voltage
	3V DC			66.7mA	45 Ω		
	5V DC			40.0mA	125 Ω		
	6V DC			33.3mA	180 Ω		
	9V DC			22.2mA	405 Ω		
	12V DC			16.7mA	720 Ω		
	24V DC			8.3mA	2,880 Ω		
48V DC	4.2mA	11,520 Ω					

2) 2 coil latching type

Type	Nominal coil voltage	Set voltage (at 20°C 68°F)	Reset voltage (at 20°C 68°F)	Nominal operating current [$\pm 10\%$] (at 20°C 68°F)		Coil resistance [$\pm 10\%$] (at 20°C 68°F)		Nominal operating power		Max. applied voltage (at 50°C 122°F)
				Set coil	Reset coil	Set coil	Reset coil	Set coil	Reset coil	
High sensitivity (S) type	1.5V DC*	1 Form C: 80%V or less of nominal voltage	1 Form C: 80%V or less of nominal voltage	120mA	120mA	12.5 Ω	12.5 Ω	180mW	180mW	1 Form C: 160%V of nominal voltage 2 Form C: 200%V of nominal voltage
	3V DC			60mA	60mA	50 Ω	50 Ω			
	5V DC			36mA	36mA	139 Ω	139 Ω			
	6V DC			30mA	30mA	200 Ω	200 Ω			
	9V DC	2 Form C: 70%V or less of nominal voltage (Initial)	2 Form C: 70%V or less of nominal voltage (Initial)	20mA	20mA	450 Ω	450 Ω			
	12V DC			15mA	15mA	800 Ω	800 Ω			
	24V DC			7.5mA	7.5mA	3,200 Ω	3,200 Ω			
	48V DC			3.75mA	3.75mA	12,800 Ω	12,800 Ω			

* Nominal coil voltage 1.5V type are 1 Form C only.

2. Specifications

Characteristics	Item		Specifications	
			1 Form C	2 Form C
Contact	Arrangement		1 Form C	2 Form C
	Initial contact resistance, max.		Max. 50 mΩ (By voltage drop 6 V DC 1A)	
	Contact material		Ag+Au clad	
Rating	Nominal switching capacity		2 A 30 V DC (resistive load)	
	Max. switching power		60 W, 125 VA (resistive load)	
	Max. switching voltage		220 V DC, 250 V AC	
	Max. carrying current		3 A	
	Min. switching capacity (Reference value)*1		10μA 10m V DC	
	Nominal operating power		Single side stable (S type: 200 mW); latching (S type: 180 mW)	
Electrical characteristics	Insulation resistance (Initial)		Min. 100MΩ (at 500V DC) Measurement at same location as "Initial breakdown voltage" section.	
	Breakdown voltage (Initial)	Between open contacts	1,000 Vrms for 1min. (500 Vrms for 1min: 1 Form C type) (Detection current: 10mA.)	
		Between contact and coil	1,500 Vrms for 1min. (1,000 Vrms for 1min: 1 Form C type) (Detection current: 10mA.)	
	Temperature rise		Max. 65°C (By resistive method, nominal coil voltage applied to the coil, contact carrying current: 2A.)	
	Operate time [Set time] (at 20°C 68°F)		Max. 10 ms [10 ms] (Nominal coil voltage applied to the coil, excluding contact bounce time.)	
	Release time [Reset time] (at 20°C 68°F)		Max. 5 ms [10 ms] (Nominal coil voltage applied to the coil, excluding contact bounce time.) (without diode)	
Mechanical characteristics	Shock resistance	Functional*2	Min. 490 m/s ²	Min. 490 m/s ²
		Destructive	Min. 980 m/s ² (Half-wave pulse of sine wave: 6 ms.)	
	Vibration resistance	Functional	10 to 55 Hz at double amplitude of 3.3 mm (Detection time: 10μs.)	
		Destructive	10 to 55 Hz at double amplitude of 5 mm	
Expected life	Mechanical		Min. 10 ⁸ (10 ⁷ : 1 Form C latching type) (at 600 cpm)	
	Electrical		Min. 5×10 ⁵ rated load (at 60 cpm)	
Conditions	Conditions for operation, transport and storage*3		Ambient temperature: -40°C to +70°C -40°F to +158°F Humidity: 5 to 85% R.H. (Not freezing and condensing at low temperature)	
	Max. operating speed (at rated load)		60 cpm	
Unit weight			Approx. 3 g .11 oz	Approx. 4g .14oz

Notes: *1 This value can change due to the switching frequency, environmental conditions, and desired reliability level, therefore it is recommended to check this with the actual load. (TX/TX-S/TX-D relay AgPd contact type are available for low level load switching [10V DC, 10mA max. level])

*2 Half-wave pulse of sine wave: 11ms; detection time: 10μs

*3 Refer to 6. Conditions for operation, transport and storage mentioned in AMBIENT ENVIRONMENT.

REFERENCE DATA

1. Maximum switching capacity

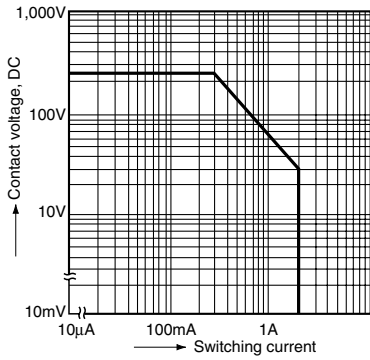

2. Life curve (Resistive load)

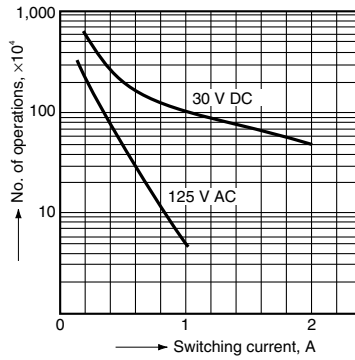

3. Contact reliability for AC loads

Tested sample: DS2E-S-DC24V 10 pcs.
 Operating speed: 20 cpm.
 Detection level: 200 mΩ



4. Operate and release time characteristics (2 Form C single side stable type)

Test condition: Without diode connected to coil in parallel

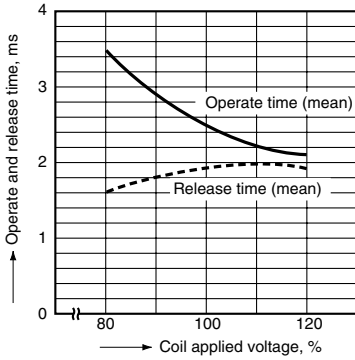

5-(1). Influence of adjacent mounting (1 Form C)



5-(2). Influence of adjacent mounting (2 Form C)

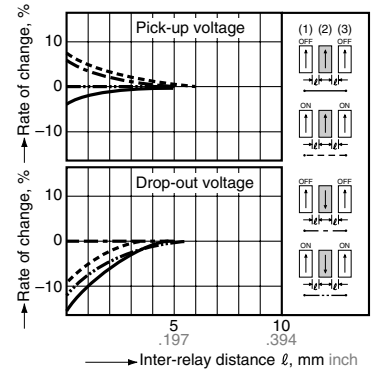

DIMENSIONS (mm inch)

The CAD data of the products with a **CAD Data** mark can be downloaded from: <http://industrial.panasonic.com/ac/e/>

DS (1 Form C)

Single side stable, 2 coil latching

CAD Data

External dimensions



General tolerance: $\pm 0.3 \pm 0.12$

PC board pattern (Bottom view)

Single side stable

2 coil latching

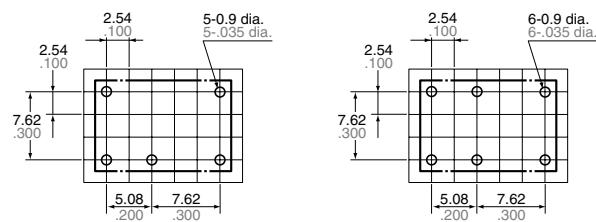

Schematic (Bottom view)

Single side stable

2 coil latching



(Deenergized condition)

(Reset condition)

Tolerance: $\pm 0.1 \pm 0.04$

Note: External dimensions of 1 coil latching types are same as single side stable type.

DS (2 Form C)

Single side stable

CAD Data

External dimensions

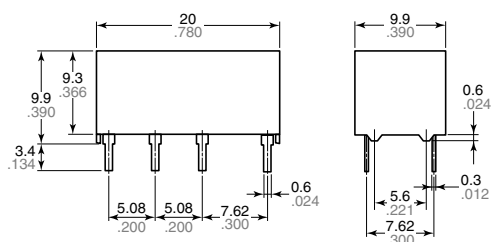

General tolerance: $\pm 0.3 \pm 0.12$

PC board pattern (Bottom view)

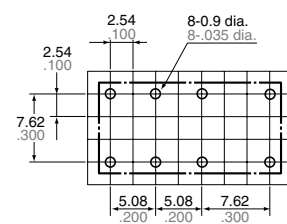

Schematic (Bottom view)

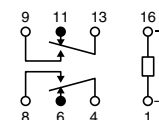

(Deenergized condition)

Tolerance: $\pm 0.1 \pm 0.04$

Note: External dimensions of 1 coil latching types are same as single side stable type.

DS (2 Form C)

2 coil latching

CAD Data

External dimensions

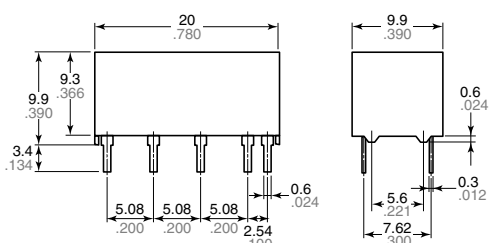

General tolerance: $\pm 0.3 \pm 0.12$

PC board pattern (Bottom view)

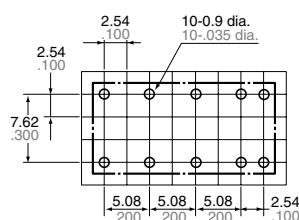

Schematic (Bottom view)

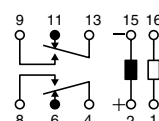

(Reset condition)

Tolerance: $\pm 0.1 \pm 0.04$

NOTES

1. Coil connection

When connecting coils, refer to the wiring diagram to prevent mis-operation or malfunction.

For general cautions for use, please refer to the “Cautions for use of Signal Relays” or “General Application Guidelines”.

Mouser Electronics

Authorized Distributor

Click to View Pricing, Inventory, Delivery & Lifecycle Information:

Panasonic:

[DS2E-ML2-DC12V](#) [DS2E-ML2-DC24V](#) [DS2E-ML2-DC5V](#) [DS2E-ML2-DC9V](#) [DS1E-ML2-DC1.5V](#) [DS1E-ML2-DC3V](#)
[DS1E-ML2-DC48V](#) [DS1E-ML2-DC9V](#) [DS2E-ML2-DC1.5V](#) [DS2E-ML2-DC48V](#) [DS2E-ML2-DC6V](#) [DS1E-ML2-DC12V](#)
[DS1E-ML2-DC5V](#) [DS1E-ML-DC12V](#) [DS1E-ML2-DC24V](#) [DS1E-ML2-DC6V](#) [DS2E-ML2-DC3V](#) [DS1E-ML2-DC24V-R](#)
[DS1E-ML2-DC3V-R](#) [DS1E-ML2-DC5V-R](#) [DS1E-ML-DC1.5V](#) [DS1E-ML-DC24V](#) [DS1E-ML-DC48V](#) [DS1E-ML-DC5V](#)
[DS1E-ML-DC6V](#) [DS1E-ML-DC9V](#) [DS2E-ML2-DC12V-R](#) [DS2E-ML2-DC5V-R](#) [DS2E-ML2-DC5V-TB](#) [DS2E-ML-DC12V](#)
[DS2E-ML-DC24V](#) [DS2E-ML-DC5V](#) [DS2E-ML-DC6V](#)

Компания «Океан Электроники» предлагает заключение долгосрочных отношений при поставках импортных электронных компонентов на взаимовыгодных условиях!

Наши преимущества:

- Поставка оригинальных импортных электронных компонентов напрямую с производств Америки, Европы и Азии, а так же с крупнейших складов мира;
- Широкая линейка поставок активных и пассивных импортных электронных компонентов (более 30 млн. наименований);
- Поставка сложных, дефицитных, либо снятых с производства позиций;
- Оперативные сроки поставки под заказ (от 5 рабочих дней);
- Экспресс доставка в любую точку России;
- Помощь Конструкторского Отдела и консультации квалифицированных инженеров;
- Техническая поддержка проекта, помощь в подборе аналогов, поставка прототипов;
- Поставка электронных компонентов под контролем ВП;
- Система менеджмента качества сертифицирована по Международному стандарту ISO 9001;
- При необходимости вся продукция военного и аэрокосмического назначения проходит испытания и сертификацию в лаборатории (по согласованию с заказчиком);
- Поставка специализированных компонентов военного и аэрокосмического уровня качества (Xilinx, Altera, Analog Devices, Intersil, Interpoint, Microsemi, Actel, Aeroflex, Peregrine, VPT, Syfer, Eurofarad, Texas Instruments, MS Kennedy, Miteq, Cobham, E2V, MA-COM, Hittite, Mini-Circuits, General Dynamics и др.);

Компания «Океан Электроники» является официальным дистрибьютором и эксклюзивным представителем в России одного из крупнейших производителей разъемов военного и аэрокосмического назначения «JONHON», а так же официальным дистрибьютором и эксклюзивным представителем в России производителя высокотехнологичных и надежных решений для передачи СВЧ сигналов «FORSTAR».



JONHON

«JONHON» (основан в 1970 г.)

Разъемы специального, военного и аэрокосмического назначения:

(Применяются в военной, авиационной, аэрокосмической, морской, железнодорожной, горно- и нефтедобывающей отраслях промышленности)

«FORSTAR» (основан в 1998 г.)

ВЧ соединители, коаксиальные кабели, кабельные сборки и микроволновые компоненты:

(Применяются в телекоммуникациях гражданского и специального назначения, в средствах связи, РЛС, а так же военной, авиационной и аэрокосмической отраслях промышленности).



Телефон: 8 (812) 309-75-97 (многоканальный)

Факс: 8 (812) 320-03-32

Электронная почта: ocean@oceanchips.ru

Web: <http://oceanchips.ru/>

Адрес: 198099, г. Санкт-Петербург, ул. Калинина, д. 2, корп. 4, лит. А