

E2FM

Highly Durable Proximity Sensor for Tough Environments



- Completely stainless-steel housing
- Aluminum chip immunity
- Embedding installation to metal (steel) fittings
- Chemical resistance certified by Ecolab Europe
- Lineup includes pre-wire models and DC 3-wire NPN output models with fluororesin coating.



Be sure to read *Safety Precautions* on page 9.

Note: Models with a fluororesin coating also use vinyl chloride for the cable material and require separate protection.

For the most recent information on models that have been certified for safety standards, refer to your OMRON website.

Features

One-piece completely stainless-steel housing with a face thickness of 0.8 mm

The face thickness is approximately 4 times that of previous models (E2ES) to enable sensing in even more severe conditions than ever.



Brush Test



After 3 Minutes



E2FM

E2EQ

(Spatter-resistant)

The stainless-steel head means almost no wear when cleaned with a metal brush.

Continuous Impact Test

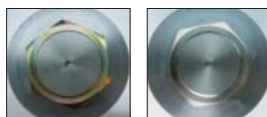

E2ES

E2FM

The E2ES with a top wall thickness of 0.2 mm was **penetrated** after 10,000 impacts.

The E2FM was not **penetrated** after 250,000 impacts (depth: 0.26 mm).

More than 20 times the durability of the E2ES!

Chemical and Detergent Proof

The one-piece completely stainless-steel housing of the sensing section withstands the following chemicals better.

- Sodium chloride
- Gasoline
- Dilute sodium hydroxide
- Dilute hydrochloric acid
- Mineral oil
- Barium hydroxide
- Any many others

Note: Cannot be used for explosion-proof applications.

Built-in Chip Immunity

Chip immunity performance has been provided to greatly reduce false signals caused by spatter accumulation and other causes, almost eliminating the needs for cleaning, e.g., with metal brushes.



Flush Mounting

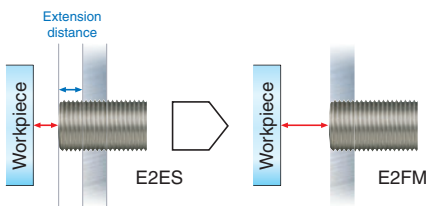

Not influenced by surrounding installation environment.

Note: When mounted in steel.



Main Performance Comparison to Previous OMRON Products

Face thickness

	E2FM	E2ES
M8	0.4 mm	---
M12	0.8 mm	---
M18	0.8 mm	0.2 mm
M30	0.8 mm	0.2 mm

Sensing distance

	E2FM	E2ES
M8	1.5 mm	---
M12	2.0 mm	---
M18	5.0 mm	4.0 mm
M30	10.0 mm	8.0 mm

Response frequency

	E2FM	E2ES
M8	200 Hz	---
M12	100 Hz	---
M18	100 Hz	12 Hz
M30	50 Hz	8 Hz

Ambient operating temperature

E2FM	E2ES
-25 to 70°C	0 to 50°C

The chemical resistance has been certified by Ecolab Europe

ECOLAB

Ecolab GmbH & Co. OHG
P.O. Box 13 94 96
D-40551 Düsseldorf
certifies that for

OMRON
OMRON Manufacturing of Germany GmbH
Carl-Benz-Strasse 4
71154 Nuttingen

material resistance tests

were performed with cleaning substances P3-Aopax 56, P3-Aopax 66, P3-Aopax 91 and demineralized water as a zero reference factor.

The material resistance of the tested series
Inductive Proximity Sensor E2FM

to the P3 products used in the test can be considered to be positive according to the cleaning procedures mentioned overleaf.

Düsseldorf, 14th February 2006

Ecolab GmbH & Co. OHG
L.V. *Thomas Tyborski*
L.V. *Reinhold Lauff*

ECOLAB

This certificate is based on:

- documented test procedures (test no.: FAEP3-E Nr. 40-1) according to material resistance
- defined product descriptions
- standardized cleaning procedure

Test procedure
Ecolab test P&E Nr. 40-1

Dyeing test:

- Complete immersion in solution/liquid

Test period:

- 15 days

Temperature:

- room temperature (constant)

Analysis:

- Visual judgement like swelling, brittleness, discoloring
- compared to zero-reference factor (demineralized water)
- Photometric documentation

Product specifications:

P3-Aopax 56:
Acid foam cleaning substance for food and beverage industry

P3-Aopax 66:
Alkaline foam cleaning detergent with active chlorine for machine cleaning in food and beverage industry

P3-Aopax 91:
Neutral disinfectant agent based on quaternary ammonium compounds (QAV) for the food industry

Cleaning plan for food and beverage industry*

- Rinsing with water 48 – 50°C**
Rinsing with the pressure. Rinsing from top to bottom in the direction of the drains. Cleaning of the drains.
- Foaming from bottom to top**
alkaline: P3-Aopax 66 2 – 3 % daily
acid: P3-Aopax 56 2 % on demand
temperature: cold up to 40°C
contact time: 15 min. recommended
- Rinsing with water 48 – 50°C**
Rinsing from top to bottom with the pressure

Spray disinfection P3-Aopax 91 1-2 %, 30-40 minutes

*not applicable

Ordering Information

Sensors [Refer to *Dimensions* on page 10.]

DC 2-Wire, Pre-wired Models

Size	Sensing distance		Output	Operation mode	Model
Shielded 	M8	1.5 mm	DC 2-Wire (polarity)	NO	E2FM-X1R5D1 2M *
	M12	2 mm			E2FM-X2D1 2M *
	M18	5 mm			E2FM-X5D1 2M *
	M30	10 mm			E2FM-X10D1 2M *

Note: Models with NC operation are also available. Ask your OMRON representative for details.

* Fluororesin-coated models are also available. The model numbers are E2FM-QX□D1. The cable material, however, is vinyl chloride and requires separate protection.

DC 2-wire Pre-wired Smartclick Connector Models (M12)

Size	Sensing distance		Output	Operation mode	Model
Shielded 	M8	1.5 mm	Polarity Pin allocations: 1-4	NO	E2FM-X1R5D1-M1TGJ 0.3M
			No polarity Pin allocations: 3-4		E2FM-X2D1-M1TGJ 0.3M
	M12	2 mm	Polarity Pin allocations: 1-4		E2FM-X2D1-M1TGJ-T 0.3M
			No polarity Pin allocations: 3-4		E2FM-X5D1-M1TGJ 0.3M
	M18	5 mm	Polarity Pin allocations: 1-4		E2FM-X5D1-M1TGJ-T 0.3M
			No polarity Pin allocations: 3-4		E2FM-X10D1-M1TGJ 0.3M
	M30	10 mm	Polarity Pin allocations: 1-4		E2FM-X10D1-M1TGJ-T 0.3M
			No polarity Pin allocations: 3-4		

DC 3-Wire, Pre-wired Models

Size	Sensing distance		Model	
			Output configuration: NPN NO	Output configuration: PNP NO
Shielded 	M8	1.5 mm	E2FM-X1R5C1 2M	E2FM-X1R5B1 2M
	M12	2 mm	E2FM-X2C1 2M	E2FM-X2B1 2M
	M18	5 mm	E2FM-X5C1 2M	E2FM-X5B1 2M
	M30	10 mm	E2FM-X10C1 2M	E2FM-X10B1 2M

Note: Models with NC operation are also available. Ask your OMRON representative for details.

DC 3-Wire, M12 Connector Models



Size	Sensing distance		Model	
			Output configuration: NPN NO	Output configuration: PNP NO
Shielded 	M8	1.5 mm	E2FM-X1R5C1-M1	E2FM-X1R5B1-M1 *
	M12	2 mm	E2FM-X2C1-M1	E2FM-X2B1-M1 *
	M18	5 mm	E2FM-X5C1-M1	E2FM-X5B1-M1 *
	M30	10 mm	E2FM-X10C1-M1	E2FM-X10B1-M1 *

* Fluororesin-coated models are also available. The model numbers are E2FM-QX□B1-M1. The cable material, however, is vinyl chloride and requires separate protection.

Accessories (Order Separately)

Sensor I/O Connectors (M12, Sockets on One Cable End)

(Models for Connectors and with Pre-wired Connectors: A Connector is not provided with the Sensor. Be sure to order a Connector separately.)
[Refer to XS2, XS5.]

Appearance	Cable length	Sensor I/O Connector model number	Applicable Proximity Sensor model number
 Straight	2m	XS2F-D421-DC0-F	E2FM-X□C1-M1 E2FM-X□B1-M1
	5m	XS2F-D421-GC0-F	
 L-shape	2m	XS2F-D422-DC0-F	
	5m	XS2F-D422-GC0-F	
 Smartclick Connector Relay Models (M12)	2m	XS5F-D421-D80-F	E2FM-X□D1-M1TGJ E2FM-X□D1-M1TGJ-T
	5m	XS5F-D421-G80-F	

Note: Refer to *Introduction to Sensor I/O Connectors* for details.

Ratings and Specifications

DC 2-Wire (E2FM-X□D□)

Item	Size	M8	M12	M18	M30	M12	M18	M30	
	Shielded Model	Shielded							
		E2FM-X1R5D1-□	E2FM-X2D1-□	E2FM-X5D1-□	E2FM-X10D1-□	E2FM-X2D1-M1T1GJ-T	E2FM-X5D1-M1T1GJ-T	E2FM-X10D1-M1T1GJ-T	
Sensing distance		1.5 mm±10%	2 mm±10%	5 mm±10%	10 mm±10%	2 mm±10%	5 mm±10%	10 mm±10%	
Set distance		0 to 1.05 mm	0 to 1.4 mm	0 to 3.5 mm	0 to 7 mm	0 to 1.4 mm	0 to 3.5 mm	0 to 7 mm	
Differential travel		15% max. of sensing distance							
Sensing object		Ferrous metal (The sensing distance decreases with non-ferrous metal. Refer to <i>Engineering Data</i> on page 7.)							
Standard sensing object		Iron, 8 × 8 × 1 mm	Iron, 12 × 12 × 1 mm	Iron, 30 × 30 × 1 mm	Iron, 54 × 54 × 1 mm	Iron, 12 × 12 × 1 mm	Iron, 30 × 30 × 1 mm	Iron, 54 × 54 × 1 mm	
Response frequency *1		200 Hz	100 Hz	100 Hz	50 Hz	100 Hz	100 Hz	50 Hz	
Power supply voltage (operating voltage range)		12 to 24 VDC (10 to 30 VDC), ripple (p-p): 10% max.							
Leakage current		0.8 mA max.							
Output configuration		With polarity				No polarity			
Control output	Switching capacity	3 to 100 mA							
	Residual voltage	3 V max. (Load current: 100 mA max., Cable length: 2 m)				5 V max. (Load current: 100 mA max., Cable length: 2 m)			
Indicators		Operation indicator (red LED), Setting/Operation indicator (green LED)							
Operation mode (with sensing object approaching)		NO *2							
Protection circuits		Surge suppressor, Load short-circuit protection							
Ambient temperature range		Operating/Storage: -25 to 70°C (with no icing or condensation)							
Ambient humidity range		Operating/Storage: 35% to 95% (with no condensation)							
Temperature influence		±20% max. of sensing distance at 23°C in the temperature range of -25 to 70°C.							
Voltage influence		±1% max. of sensing distance at rated voltage in the rated voltage ±15% range							
Insulation resistance		50 MΩ min. (at 500 VDC) between current-carrying parts and case							
Dielectric strength		1,000 VAC, 50/60 Hz for 1 minute between current-carrying parts and case							
Vibration resistance		Destruction: 10 to 55 Hz, 1.5-mm double amplitude for 2 hours each in X, Y, and Z directions							
Shock resistance		Destruction: 500 m/s ² 10 times each in X, Y, and Z directions	Destruction: 1,000 m/s ² 10 times each in X, Y, and Z directions						
Degree of protection		IEC 60529 IP67							
Connection method		Unmarked: Pre-wired Models (Standard cable length: 2 m) Models ending with -M1GJ-□: Pre-wired Connector Models (Standard cable length: 300 mm)							

Item	Size	M8	M12	M18	M30	M12	M18	M30
	Shielded	Shielded						
	Model	E2FM-X1R5D1-□	E2FM-X2D1-□	E2FM-X5D1-□	E2FM-X10D1-□	E2FM-X2D1-M1T1GJ-T	E2FM-X5D1-M1T1GJ-T	E2FM-X10D1-M1T1GJ-T
Weight (packed state)	Pre-wired Models (2 m)	Approx. 105 g	Approx. 190 g	Approx. 215 g	Approx. 295 g	---	---	---
	Pre-wired Connector Models	Approx. 65 g	Approx. 85 g	Approx. 110 g	Approx. 190 g	Approx. 85 g	Approx. 110 g	Approx. 190 g
Materials	Case	Stainless steel (SUS303)						
	Sensing surface	Stainless steel (SUS303)						
	(thickness)	(0.4 mm)	(0.8 mm)			(0.8 mm)		
	Clamping nuts	Stainless steel (SUS303)						
	Cable	PVC (flame retardant)						
	Toothed washer	Zinc-plated iron						
Accessories	Instruction manual							

*1. The response frequency of the DC switching section is an average value. Measurement conditions are as follows: standard sensing object, a distance of twice the standard sensing object, and a set distance of half the sensing distance.

*2. NC (normally closed) models are also available. Contact your OMRON representative.

DC 3-Wire (E2FM-X□C□, E2FM-X□B□)

Item	Size	M8	M12	M18	M30
	Shielded	Shielded			
	Model	E2FM-X1R5□	E2FM-X2□	E2FM-X5□	E2FM-X10□
Sensing distance		1.5 mm±10%	2 mm±10%	5 mm±10%	10 mm±10%
Set distance		0 to 1.05 mm	0 to 1.4 mm	0 to 3.5 mm	0 to 7 mm
Differential travel		15% max. of sensing distance			
Sensing object		Ferrous metal (The sensing distance decreases with non-ferrous metal. Refer to <i>Engineering Data</i> on page 7.)			
Standard sensing object		Iron, 8 × 8 × 1 mm	Iron, 12 × 12 × 1 mm	Iron, 30 × 30 × 1 mm	Iron, 54 × 54 × 1 mm
Response frequency *1		200 Hz	100 Hz	100 Hz	50 Hz
Power supply voltage (operating voltage range)		12 to 24 VDC (10 to 30 VDC), ripple (p-p): 10% max.			
Current consumption		10 mA max.			
Output configuration		PNP open collector output			
Control output	Switching capacity	200 mA max.			
	Residual voltage	2 V max. (Load current: 200 mA, Cable length: 2 m)			
Indicators		Operation indicator (yellow LED)			
Operation mode (with sensing object approaching)		C1 Models: NPN open collector, NO (normally open) *2 B1 Models: PNP open collector, NO (normally open) *2			
Protection circuits		Reversed power supply polarity protection, Surge suppressor, Load short-circuit protection, and Reversed output polarity protection (except the E2FM-X1R5B1-M1)			
Ambient temperature range		Operating/Storage: -25 to 70°C (with no icing or condensation)			
Ambient humidity range		Operating/Storage: 35% to 95% (with no condensation)			
Temperature influence		±20% max. of sensing distance at 23°C in the temperature range of -25 to 70°C.			
Voltage influence		±1% max. of sensing distance in the rated voltage ±15% range (using the sensing distance at the rated voltage as standard)			
Insulation resistance		50 MΩ min. (at 500 VDC) between current-carrying parts and case			
Dielectric strength		1,000 VAC, 50/60 Hz for 1 minute between current-carrying parts and case			
Vibration resistance		Destruction: 10 to 55 Hz, 1.5-mm double amplitude for 2 hours each in X, Y, and Z directions			
Shock resistance		Destruction: 500 m/s ² 10 times each in X, Y, and Z directions	Destruction: 1,000 m/s ² 10 times each in X, Y, and Z directions		
Degree of protection		IEC 60529 IP67			
Connection method		Unmarked: Pre-wired Models (Standard cable length: 2 m) Models ending with -M1: Connector Models			
Weight (packed state)	Pre-wired Models (2 m)	---	Approx. 170 g	Approx. 190 g	Approx. 275 g
	Pre-wired Connector Models	Approx. 45 g	Approx. 55 g	Approx. 75 g	Approx. 160 g
Materials	Case	Stainless steel (SUS303)			
	Sensing surface	Stainless steel (SUS303)			
	(thickness)	(0.4 mm)	(0.8 mm)		
	Clamping nuts	Stainless steel (SUS303)			
	Toothed washer	Zinc-plated iron			
Accessories		Instruction manual			

*1. The response frequency of the DC switching section is an average value. Measurement conditions are as follows: standard sensing object, a distance of twice the standard sensing object, and a set distance of half the sensing distance.

*2. NC (normally closed) models are also available. Contact your OMRON representative.

Engineering Data (Reference Value)

Sensing Area

E2FM-X□

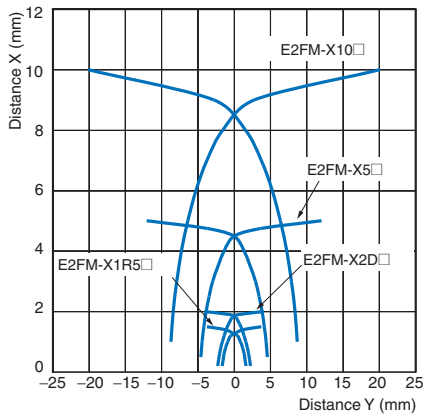

Influence of Sensing Object Size and Material

E2FM-X1R5□

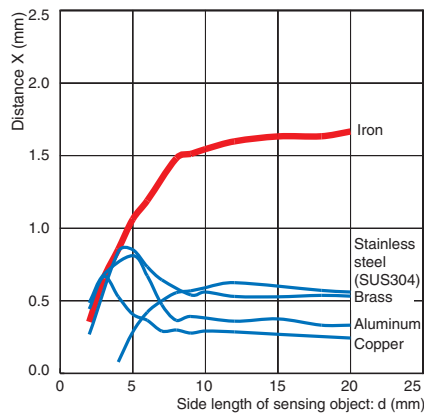

E2FM-X2□

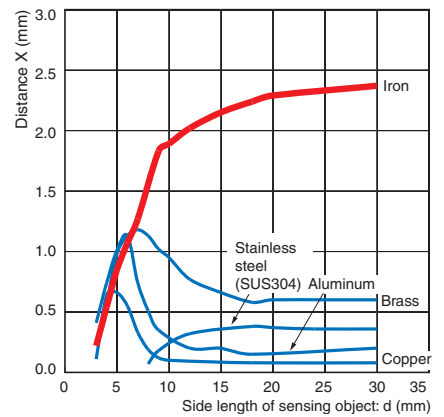

E2FM-X5□

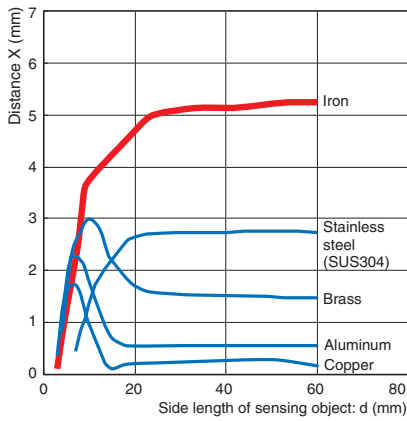

E2FM-X10□

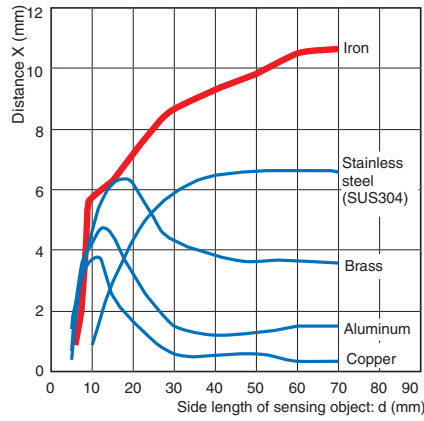

Leakage Current

E2FM-X□D1-M1TGJ (-T)

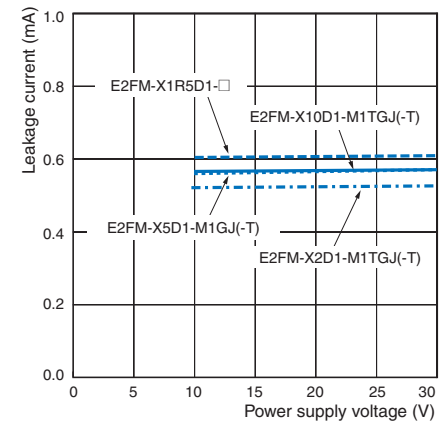

Residual Output Voltage

E2FM-X□C□/B□

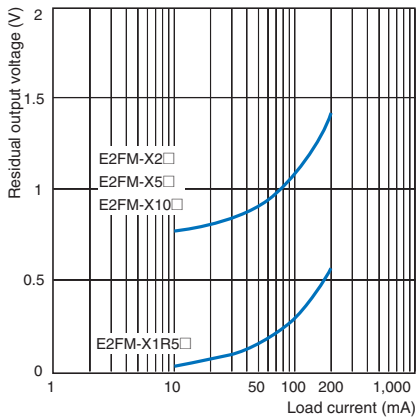

E2FM-X□D1-M1TGJ (-T)

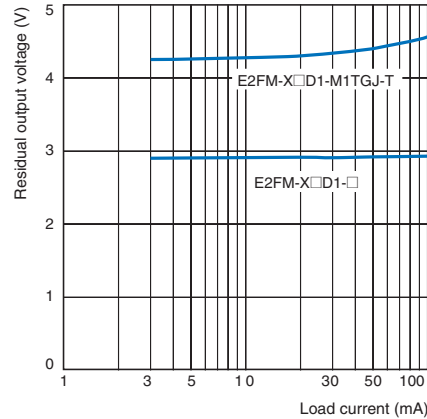

I/O Circuit Diagrams

DC 2-Wire Models

Operation mode	Model	Timing chart	Output circuit
NO	E2FM-X□D1-□	<p>Non-sensing area Unstable sensing area Stable sensing area</p> <p>Sensing object</p> <p>Rated sensing distance 100 70 (TYP) 0</p> <p>Proximity sensor</p>	<p>Connector Pin Arrangement</p> <p>Note: Pins 2 and 3 are not used.</p>
	E2FM-X□D1-M1TGJ-T	<p>ON OFF ON OFF ON OFF</p> <p>Setting indicator (green)</p> <p>Operation indicator (red)</p> <p>Control output</p>	<p>Connector Pin Arrangement</p> <p>Note: Pins 1 and 2 are not used.</p>

DC 3-Wire Models

Operation mode	Output configuration	Model	Timing chart	Output circuit
NO	NPN open-collector model	E2FM-X1R5C□ E2FM-X2C□ E2FM-X5C□ E2FM-X10C□	<p>Non-sensing area Sensing area</p> <p>Sensing object</p> <p>Rated sensing distance 100 0</p> <p>Proximity sensor</p>	<p>Connector Pin Arrangement</p> <p>Note: For Connector Models, the connection between pins 1, 4 and 3 uses an NO contact, and the connection between pins 1, 2 and 3 uses an NC contact.</p>
		PNP open-collector model	E2FM-X1R5B□ E2FM-X2B□ E2FM-X5B□ E2FM-X10B□	<p>ON OFF ON OFF</p> <p>Operation indicator (yellow)</p> <p>Control output</p>

Safety Precautions

⚠ WARNING

This product is not designed or rated for ensuring safety of persons. Do not use it for such purposes.



Never use this product with an AC power supply. Otherwise, explosion may result.



Precautions for Safe Use

The following precautions must be observed to ensure safe operation.

- Do not use the Sensor in an environment where inflammable or explosive gas is present.
- Do not attempt to disassemble, repair, or modify any Sensors.
- Power Supply Voltage
Do not use a voltage that exceeds the rated operating voltage range. Applying a voltage that is higher than the operating voltage range may result in explosion or fire.
- Incorrect Wiring
Be sure that the power supply polarity and other wiring is correct. Incorrect wiring may cause explosion or fire.
- Connection without a Load
If the power supply is connected directly without a load, the internal elements may explode or burn. Be sure to insert a load when connecting the power supply.

Precautions for Correct Use

Do not use the Sensor under ambient conditions that exceed the ratings.

- Do not use the Sensor in the following locations.
 - Outdoor locations directly subject to sunlight, rain, snow, or water droplets
 - Locations subject to atmospheres with chemical vapors, in particular solvents and acids
 - Locations subject to corrosive gas
- The Sensor may malfunction if used near ultrasonic cleaning equipment, high-frequency equipment, transceivers, cellular phones, inverters, or other devices that generate a high-frequency electric field. Refer to the *Technical Guide Photoelectric Sensors* for typical measures.
- Laying the Sensor wiring in the same conduit or duct as high-voltage wires or power lines may result in incorrect operation and damage due to induction. Wire the Sensor using a separate conduit or independent conduit.
- Cleaning
Never use thinner or other solvents. Otherwise, the Sensor surface may be dissolved.

● Design

Influence of Surrounding Metal

When the Proximity Sensor is embedded in metal, make sure that the clearances given in the following table are maintained. The values depend on the type of nuts used for mounting. Be sure to use the supplied nuts (SUS303).

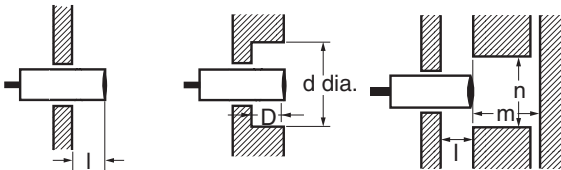

(Unit: mm)

Model	Item Embedding material	l	d	D	m	n
E2FM-X1R5□	Iron	0	8	0	4.5	30
	Aluminum	10	50	10	4.5	50
E2FM-X2□	Iron	0	12	0	8	40
	Aluminum	16	70	16	8	70
E2FM-X5□	Iron	0	18	0	20	60
	Aluminum	16	80	16	20	80
E2FM-X10□	Iron	0	30	0	40	100
	Aluminum	24	120	24	40	120

Note: The influence from other non-magnetic surrounding metals is nearly the same as that from aluminum.

Mutual Interference

When installing two or more Sensors face-to-face or side-by-side, ensure that the minimum distances given in the following table are maintained.

(Unit: mm)

Model	Item	A	B
E2FM-X1R5□		35	30
E2FM-X2□		40	35
E2FM-X5□		65	60
E2FM-X10□		110	100

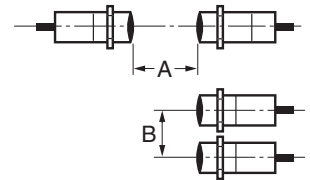

Chips from Cutting Aluminum

Normally, chips from cutting aluminum or cast iron will not cause a detection signal to be output even if it adheres to or accumulates on the detection surface. In the following cases, however, a detection signal may be output. Remove the cutting chips in these cases.

- If $d \geq \frac{2}{3} D$ at the center of the detection surface where d is the cutting chip size and D is the detection surface size

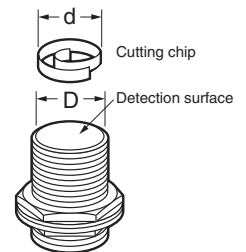

- If the cutting chips are pressed down

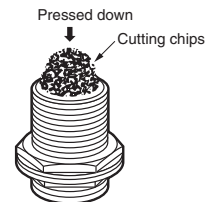

● Mounting

Do not tighten the nut with excessive force. A washer must be used with the nut. Do not use tightening force that exceeds the values in the following table.

Model	Torque
E2FM-X1R5□	9 N·m
E2FM-X2□	30 N·m
E2FM-X5□	70 N·m
E2FM-X10□	180 N·m



Dimensions

Tolerance class IT16 applies to dimensions in this data sheet unless otherwise specified.

Sensors

Pre-wired Models

E2FM-X1R5

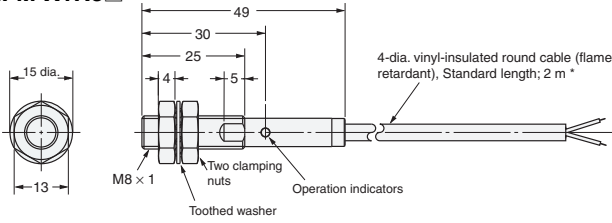

* 4-dia. vinyl-insulated round cable with 2 conductors
(Conductor cross section: 0.2 mm², Insulator diameter: 1.4 mm)
4-dia. vinyl-insulated round cable with 3 conductors
(Conductor cross section: 0.2 mm², Insulator diameter: 1.2 mm)

E2FM-X2

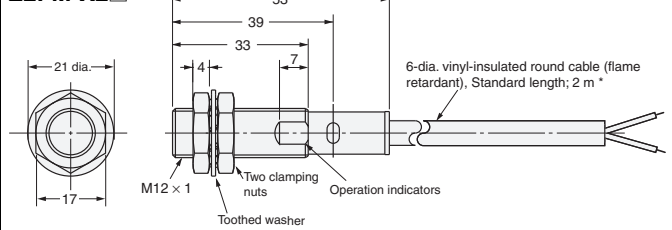

* 6-dia. vinyl-insulated round cable with 2 conductors
(Conductor cross section: 0.5 mm², Insulator diameter: 1.75 mm)
6-dia. vinyl-insulated round cable with 3 conductors
(Conductor cross section: 0.5 mm², Insulator diameter: 1.75 mm)

E2FM-X5

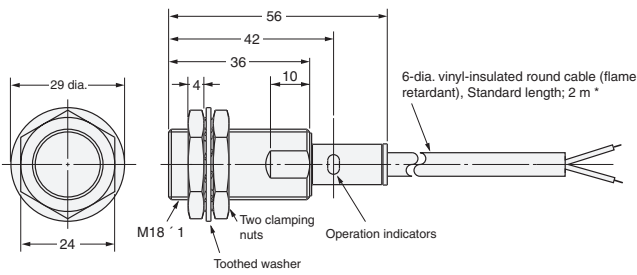

* 6-dia. vinyl-insulated round cable with 2 conductors
(Conductor cross section: 0.5 mm², Insulator diameter: 1.75 mm)
6-dia. vinyl-insulated round cable with 3 conductors
(Conductor cross section: 0.5 mm², Insulator diameter: 1.75 mm)

E2FM-X10

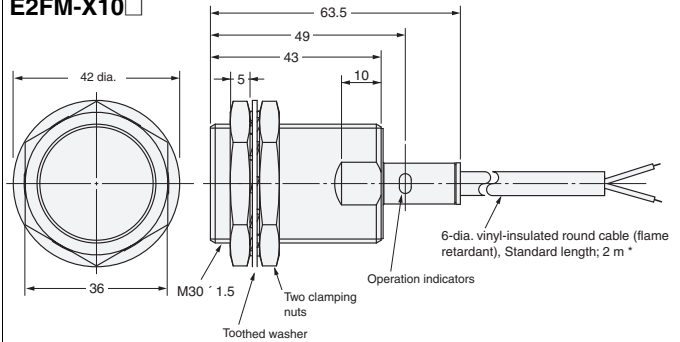

* 6-dia. vinyl-insulated round cable with 2 conductors
(Conductor cross section: 0.5 mm², Insulator diameter: 1.75 mm)
6-dia. vinyl-insulated round cable with 3 conductors
(Conductor cross section: 0.5 mm², Insulator diameter: 1.75 mm)

Pre-wired Connector Models

E2FM-X1R5D-M1TGJ

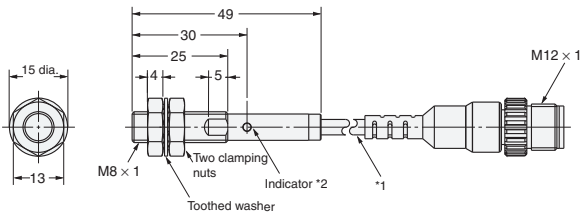

*1. 4-dia. vinyl-insulated round cable (flame retardant), Standard length; 300 mm
*2. Operation indicator (red/green)
Setting indicator (green)

E2FM-X2D-M1TGJ

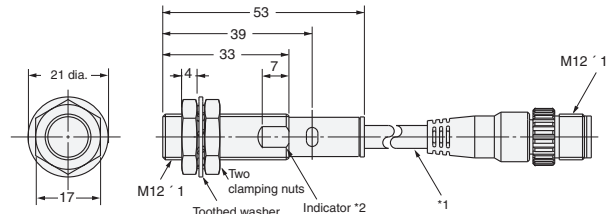

*1. 6-dia. vinyl-insulated round cable (flame retardant), Standard length; 300 mm
*2. Operation indicator (red/green)
Setting indicator (green)

E2FM-X5D-M1TGJ

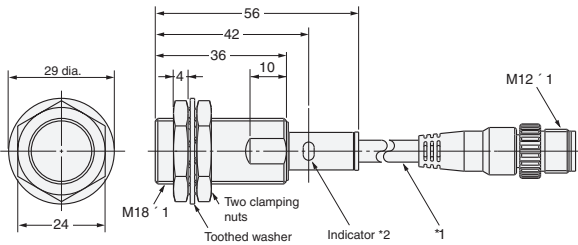

*1. 6-dia. vinyl-insulated round cable (flame retardant), Standard length; 300 mm
*2. Operation indicator (red/green)
Setting indicator (green)

E2FM-X10D-M1TGJ

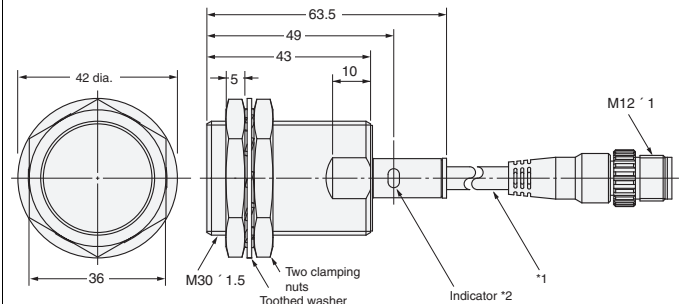

*1. 6-dia. vinyl-insulated round cable (flame retardant), Standard length; 300 mm
*2. Operation indicator (red/green)
Setting indicator (green)

M12 Connector Models

E2FM-X1R5□□-M1

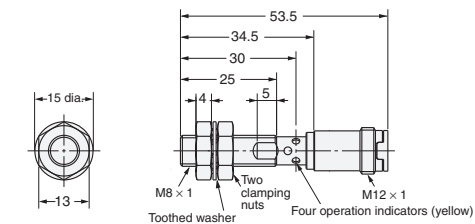

E2FM-X2□□-M1

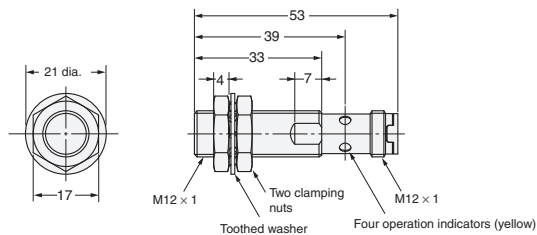

E2FM-X5□□-M1

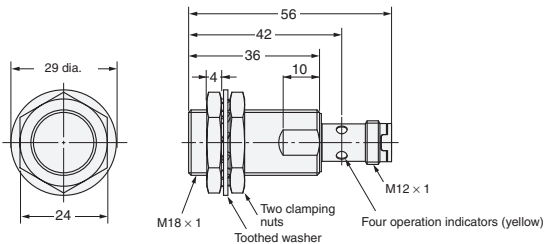

E2FM-X10□□-M1

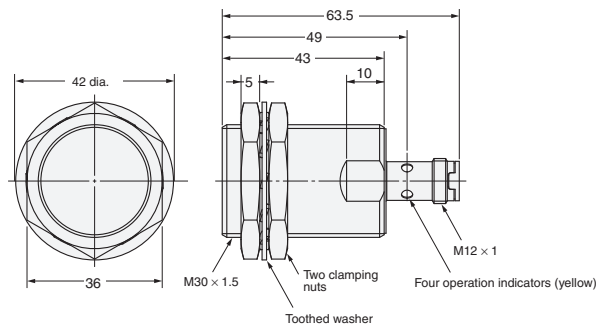

Mounting Hole Dimensions

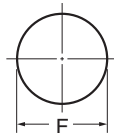

Dimension	M8	M12	M18	M30
F (mm)	8.5 ^{+0.5} ₀ dia.	12.5 ^{+0.5} ₀ dia.	18.5 ^{+0.5} ₀ dia.	30.5 ^{+0.5} ₀ dia.

Terms and Conditions Agreement

Read and understand this catalog.

Please read and understand this catalog before purchasing the products. Please consult your OMRON representative if you have any questions or comments.

Warranties.

(a) Exclusive Warranty. Omron's exclusive warranty is that the Products will be free from defects in materials and workmanship for a period of twelve months from the date of sale by Omron (or such other period expressed in writing by Omron). Omron disclaims all other warranties, express or implied.

(b) Limitations. OMRON MAKES NO WARRANTY OR REPRESENTATION, EXPRESS OR IMPLIED, ABOUT NON-INFRINGEMENT, MERCHANTABILITY OR FITNESS FOR A PARTICULAR PURPOSE OF THE PRODUCTS. BUYER ACKNOWLEDGES THAT IT ALONE HAS DETERMINED THAT THE PRODUCTS WILL SUITABLY MEET THE REQUIREMENTS OF THEIR INTENDED USE.

Omron further disclaims all warranties and responsibility of any type for claims or expenses based on infringement by the Products or otherwise of any intellectual property right. (c) Buyer Remedy. Omron's sole obligation hereunder shall be, at Omron's election, to (i) replace (in the form originally shipped with Buyer responsible for labor charges for removal or replacement thereof) the non-complying Product, (ii) repair the non-complying Product, or (iii) repay or credit Buyer an amount equal to the purchase price of the non-complying Product; provided that in no event shall Omron be responsible for warranty, repair, indemnity or any other claims or expenses regarding the Products unless Omron's analysis confirms that the Products were properly handled, stored, installed and maintained and not subject to contamination, abuse, misuse or inappropriate modification. Return of any Products by Buyer must be approved in writing by Omron before shipment. Omron Companies shall not be liable for the suitability or unsuitability or the results from the use of Products in combination with any electrical or electronic components, circuits, system assemblies or any other materials or substances or environments. Any advice, recommendations or information given orally or in writing, are not to be construed as an amendment or addition to the above warranty.

See <http://www.omron.com/global/> or contact your Omron representative for published information.

Limitation on Liability; Etc.

OMRON COMPANIES SHALL NOT BE LIABLE FOR SPECIAL, INDIRECT, INCIDENTAL, OR CONSEQUENTIAL DAMAGES, LOSS OF PROFITS OR PRODUCTION OR COMMERCIAL LOSS IN ANY WAY CONNECTED WITH THE PRODUCTS, WHETHER SUCH CLAIM IS BASED IN CONTRACT, WARRANTY, NEGLIGENCE OR STRICT LIABILITY.

Further, in no event shall liability of Omron Companies exceed the individual price of the Product on which liability is asserted.

Suitability of Use.

Omron Companies shall not be responsible for conformity with any standards, codes or regulations which apply to the combination of the Product in the Buyer's application or use of the Product. At Buyer's request, Omron will provide applicable third party certification documents identifying ratings and limitations of use which apply to the Product. This information by itself is not sufficient for a complete determination of the suitability of the Product in combination with the end product, machine, system, or other application or use. Buyer shall be solely responsible for determining appropriateness of the particular Product with respect to Buyer's application, product or system. Buyer shall take application responsibility in all cases.

NEVER USE THE PRODUCT FOR AN APPLICATION INVOLVING SERIOUS RISK TO LIFE OR PROPERTY OR IN LARGE QUANTITIES WITHOUT ENSURING THAT THE SYSTEM AS A WHOLE HAS BEEN DESIGNED TO ADDRESS THE RISKS, AND THAT THE OMRON PRODUCT(S) IS PROPERLY RATED AND INSTALLED FOR THE INTENDED USE WITHIN THE OVERALL EQUIPMENT OR SYSTEM.

Programmable Products.

Omron Companies shall not be responsible for the user's programming of a programmable Product, or any consequence thereof.

Performance Data.

Data presented in Omron Company websites, catalogs and other materials is provided as a guide for the user in determining suitability and does not constitute a warranty. It may represent the result of Omron's test conditions, and the user must correlate it to actual application requirements. Actual performance is subject to the Omron's Warranty and Limitations of Liability.

Change in Specifications.

Product specifications and accessories may be changed at any time based on improvements and other reasons. It is our practice to change part numbers when published ratings or features are changed, or when significant construction changes are made. However, some specifications of the Product may be changed without any notice. When in doubt, special part numbers may be assigned to fix or establish key specifications for your application. Please consult with your Omron's representative at any time to confirm actual specifications of purchased Product.

Errors and Omissions.

Information presented by Omron Companies has been checked and is believed to be accurate; however, no responsibility is assumed for clerical, typographical or proofreading errors or omissions.

2017.2

In the interest of product improvement, specifications are subject to change without notice.

OMRON Corporation
Industrial Automation Company

<http://www.ia.omron.com/>

(c)Copyright OMRON Corporation 2017 All Right Reserved.

Mouser Electronics

Authorized Distributor

Click to View Pricing, Inventory, Delivery & Lifecycle Information:

Omron:

[E2FM-X10B1-M1](#) [E2FM-X1R5B1-M1](#) [E2FM-X2B1-M1](#) [E2FM-X5B1-M1](#) [E2FM-QX5D1-M1GJ 0.3M](#) [E2FM-X10C1 2M](#) [E2FM-X10C1-M1](#) [E2FM-X10D1 2M](#) [E2FM-X1R5B1 2M](#) [E2FM-X1R5C1 2M](#) [E2FM-X1R5C1-M1](#) [E2FM-X1R5D1 2M](#) [E2FM-X2C1 2M](#) [E2FM-X2C1-M1](#) [E2FM-X5C1 2M](#) [E2FM-X5C1-M1](#) [E2FM-QX10D1 2M](#) [E2FM-QX10D1-M1GJ 0.3M](#) [E2FM-QX10D1-M1GJ-T 0.3M](#) [E2FM-QX1R5B1-M1](#) [E2FM-QX1R5D1 2M](#) [E2FM-QX1R5D1-M1GJ 0.3M](#) [E2FM-QX2B1-M1](#) [E2FM-QX2D1 2M](#) [E2FM-QX2D1-M1GJ 0.3M](#) [E2FM-QX2D1-M1GJ-T 0.3M](#) [E2FM-QX5D1 2M](#) [E2FM-QX5D1-M1GJ-T 0.3M](#) [E2FM-X10B1 2M](#) [E2FM-X1R5D1 5M](#) [E2FM-X2B1 2M](#) [E2FM-X2D1 2M](#) [E2FM-X5B1 2M](#) [E2FM-X5D1 2M](#) [E2FM-X5D1 5M](#) [E2FM-X5D1-M1TGJ-T 0.3M](#) [E2FM-X10D1-M1TGJ 0.3M](#) [E2FM-X1R5D1-M1TGJ 0.3M](#) [E2FM-X2D1-M1TGJ-T 0.3M](#) [E2FM-X2D1-M1TGJ 0.3M](#) [E2FM-X5D1-M1TGJ 0.3M](#) [M8-PHWS](#) [E2FM-X10D1-M1TGJ-T-US 0.3M](#) [E2FM-X5D1-M1TGJ-T-US 0.3M](#) [E2FM-X1R5D1-M1TJ-US 0.3M](#) [E2FM-X2D1-M1TGJ-T-US 0.3M](#)

Компания «Океан Электроники» предлагает заключение долгосрочных отношений при поставках импортных электронных компонентов на взаимовыгодных условиях!

Наши преимущества:

- Поставка оригинальных импортных электронных компонентов напрямую с производств Америки, Европы и Азии, а так же с крупнейших складов мира;
- Широкая линейка поставок активных и пассивных импортных электронных компонентов (более 30 млн. наименований);
- Поставка сложных, дефицитных, либо снятых с производства позиций;
- Оперативные сроки поставки под заказ (от 5 рабочих дней);
- Экспресс доставка в любую точку России;
- Помощь Конструкторского Отдела и консультации квалифицированных инженеров;
- Техническая поддержка проекта, помощь в подборе аналогов, поставка прототипов;
- Поставка электронных компонентов под контролем ВП;
- Система менеджмента качества сертифицирована по Международному стандарту ISO 9001;
- При необходимости вся продукция военного и аэрокосмического назначения проходит испытания и сертификацию в лаборатории (по согласованию с заказчиком);
- Поставка специализированных компонентов военного и аэрокосмического уровня качества (Xilinx, Altera, Analog Devices, Intersil, Interpoint, Microsemi, Actel, Aeroflex, Peregrine, VPT, Syfer, Eurofarad, Texas Instruments, MS Kennedy, Miteq, Cobham, E2V, MA-COM, Hittite, Mini-Circuits, General Dynamics и др.);

Компания «Океан Электроники» является официальным дистрибьютором и эксклюзивным представителем в России одного из крупнейших производителей разъемов военного и аэрокосмического назначения «JONHON», а так же официальным дистрибьютором и эксклюзивным представителем в России производителя высокотехнологичных и надежных решений для передачи СВЧ сигналов «FORSTAR».



JONHON

«JONHON» (основан в 1970 г.)

Разъемы специального, военного и аэрокосмического назначения:

(Применяются в военной, авиационной, аэрокосмической, морской, железнодорожной, горно- и нефтедобывающей отраслях промышленности)

«FORSTAR» (основан в 1998 г.)

ВЧ соединители, коаксиальные кабели,
кабельные сборки и микроволновые компоненты:

(Применяются в телекоммуникациях гражданского и специального назначения, в средствах связи, РЛС, а так же военной, авиационной и аэрокосмической отраслях промышленности).



Телефон: 8 (812) 309-75-97 (многоканальный)

Факс: 8 (812) 320-03-32

Электронная почта: ocean@oceanchips.ru

Web: <http://oceanchips.ru/>

Адрес: 198099, г. Санкт-Петербург, ул. Калинина, д. 2, корп. 4, лит. А