

TOSHIBA CMOS Linear Integrated Circuit Silicon Monolithic

# TCR5AM series

## 500 mA CMOS Ultra Low Drop-Out Regulator

The TCR5AM series are CMOS single-output voltage regulators with an on/off control input, featuring Ultra low dropout voltage, low inrush current and fast load transient response.

A differentiating feature is the use of a secondary bias rail as a reference voltage that allows ultra-low drop-out of 90 mV (Typ.) at  $I_{OUT} = 300$  mA ( 1.1 V output,  $V_{BAT} = 3.3$  V ).

These voltage regulators are available in fixed output voltages between 0.55 V and 3.6 V, and capable of driving up to 500 mA. Other features include over-current protection, over-temperature protection, Under-voltage-lockout and Auto-discharge function.

The TCR5AM series are offered in the ultra small plastic mold package DFN5B (1.2 mm x 1.2 mm; t 0.38 mm).

As small ceramic input and output capacitors can be used with the TCR5AM series, these devices are ideal for portable applications that require high-density board assembly such as cellular phones.

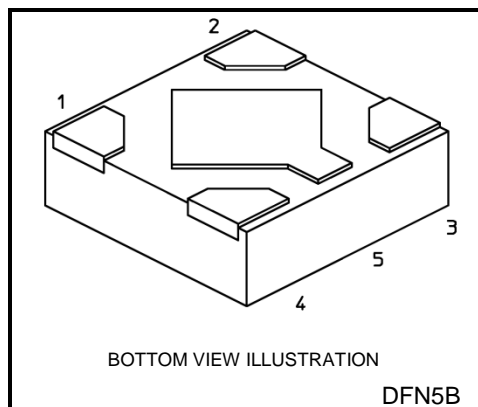

Weight : 1.4 mg ( Typ. )

## Features

- Low Drop-Out voltage  
 $V_{IN}-V_{OUT} = 90$  mV (Typ.) at 1.1 V output,  $V_{BAT} = 3.3$  V ,  $I_{OUT} = 300$  mA
- Low stand-by current (  $I_{B(OFF)} = 2$   $\mu$ A (Max) at  $V_{BAT} = 5.5$  V,  $V_{CT} = 0$  V )
- Low quiescent bias current (  $I_B = 40$   $\mu$ A (Typ.) at  $V_{BAT} = 5.5$  V,  $I_{OUT} = 0$  mA )
- Wide range Output Voltage line up (  $V_{OUT} = 0.55$  to 3.6 V )
- Over-current protection
- Over-temperature protection
- Inrush current protection circuit
- Under-voltage-lockout function
- Auto-discharge function
- Pull down connection between CONTROL and GND
- Ultra small package DFN5B (1.2 mm x 1.2 mm ; t 0.38 mm )

Start of commercial production  
2014-12

## Absolute Maximum Ratings (Ta = 25°C)

| Characteristics             | Symbol           | Rating                        | Unit         |    |
|-----------------------------|------------------|-------------------------------|--------------|----|
| Bias voltage                | V <sub>BAT</sub> | 6.0                           | V            |    |
| Input voltage               | V <sub>IN</sub>  | 6.0                           | V            |    |
| Control voltage             | V <sub>CT</sub>  | -0.3 to 6.0                   | V            |    |
| Output voltage              | V <sub>OUT</sub> | -0.3 to V <sub>IN</sub> + 0.3 | V            |    |
| Output current              | I <sub>OUT</sub> | DC                            | 500          | mA |
|                             |                  | Pulse                         | 600 (Note 1) |    |
| Power dissipation           | P <sub>D</sub>   | 600 (Note 2)                  | mW           |    |
| Operation temperature range | T <sub>opr</sub> | -40 to 85                     | °C           |    |
| Junction temperature        | T <sub>j</sub>   | 150                           | °C           |    |
| Storage temperature range   | T <sub>stg</sub> | -55 to 150                    | °C           |    |

Note: Using continuously under heavy loads (e.g. the application of high temperature/current/voltage and the significant change in temperature, etc.) may cause this product to decrease in the reliability significantly even if the operating conditions (i.e. operating temperature/current/voltage, etc.) are within the absolute maximum ratings and the operating ranges.

Please design the appropriate reliability upon reviewing the Toshiba Semiconductor Reliability Handbook ("Handling Precautions"/"Derating Concept and Methods") and individual reliability data (i.e. reliability test report and estimated failure rate, etc).

Note 1: 100 ms pulse, 50% duty cycle

Note 2: Rating at mounting on a board

Glass epoxy (FR4) board dimension: 40 mm x 40 mm x 1.6 mm, both sides of board

Metal pattern ratio: a surface approximately 50%, the reverse side approximately 50%

Through hole hall: diameter 0.5 mm x 24

## Pin Assignment (top view)

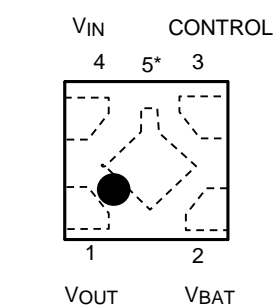

\*Center electrode is GND

## List of Products Number, Output voltage and Marking

| Product No. | V <sub>OUT</sub> (V)(Typ.) | Marking | Product No. | V <sub>OUT</sub> (V)(Typ.) | Marking |
|-------------|----------------------------|---------|-------------|----------------------------|---------|
| TCR5AM055   | 0.55                       | 0RF     | TCR5AM19    | 1.9                        | 1R9     |
| TCR5AM06    | 0.6                        | 0R6     | TCR5AM20    | 2.0                        | 2R0     |
| TCR5AM065   | 0.65                       | 0RG     | TCR5AM21    | 2.1                        | 2R1     |
| TCR5AM07    | 0.7                        | 0R7     | TCR5AM22    | 2.2                        | 2R2     |
| TCR5AM075   | 0.75                       | 0RH     | TCR5AM23    | 2.3                        | 2R3     |
| TCR5AM08    | 0.8                        | 0R8     | TCR5AM24    | 2.4                        | 2R4     |
| TCR5AM085   | 0.85                       | 0RJ     | TCR5AM25    | 2.5                        | 2R5     |
| TCR5AM09    | 0.9                        | 0R9     | TCR5AM26    | 2.6                        | 2R6     |
| TCR5AM095   | 0.95                       | 0RK     | TCR5AM27    | 2.7                        | 2R7     |
| TCR5AM10    | 1.0                        | 1R0     | TCR5AM28    | 2.8                        | 2R8     |
| TCR5AM105   | 1.05                       | 1RA     | TCR5AM285   | 2.85                       | 2RJ     |
| TCR5AM11    | 1.1                        | 1R1     | TCR5AM29    | 2.9                        | 2R9     |
| TCR5AM115   | 1.15                       | 1RB     | TCR5AM295   | 2.95                       | 2RK     |
| TCR5AM12    | 1.2                        | 1R2     | TCR5AM30    | 3.0                        | 3R0     |
| TCR5AM125   | 1.25                       | 1RC     | TCR5AM31    | 3.1                        | 3R1     |
| TCR5AM13    | 1.3                        | 1R3     | TCR5AM32    | 3.2                        | 3R2     |
| TCR5AM14    | 1.4                        | 1R4     | TCR5AM33    | 3.3                        | 3R3     |
| TCR5AM15    | 1.5                        | 1R5     | TCR5AM34    | 3.4                        | 3R4     |
| TCR5AM16    | 1.6                        | 1R6     | TCR5AM35    | 3.5                        | 3R5     |
| TCR5AM17    | 1.7                        | 1R7     | TCR5AM36    | 3.6                        | 3R6     |
| TCR5AM18    | 1.8                        | 1R8     |             |                            |         |

### Top Marking (top view)

Example: TCR5AM06 (0.6 V output)



**Block Diagram**

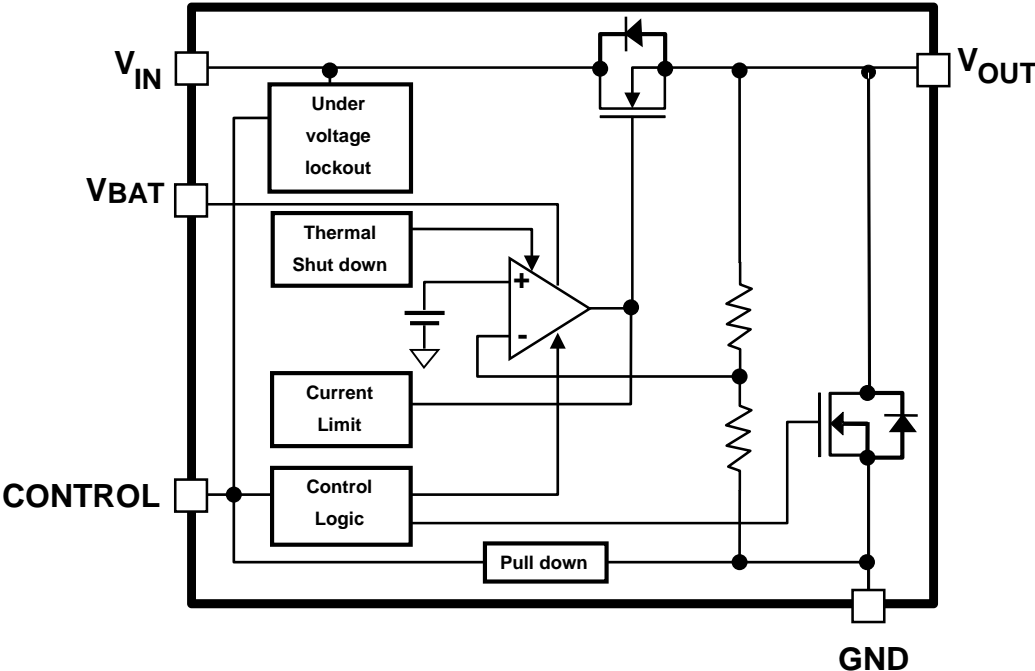

## Electrical Characteristics

(Unless otherwise specified,  $V_{IN} = V_{OUT} + 0.5 \text{ V}$ ,  $I_{OUT} = 50 \text{ mA}$ ,  $C_{IN}=C_{BAT} = 1.0 \mu\text{F}$ ,  $C_{OUT} = 2.2 \mu\text{F}$ )

| Characteristics                | Symbol           | Test Condition  | $T_j = 25^\circ\text{C}$     |                         |     | $T_j = -40 \text{ to } 85^\circ\text{C}$<br>(Note 9) |                         | Unit      |                       |
|--------------------------------|------------------|---|------------------------------|-------------------------|-----|--|-------------------------|-----------|-----------------------|
|                                |                  |   | Min                          | Typ.                    | Max | Min  | Max                     |           |                       |
| Output voltage accuracy        | $V_{OUT}$        | $I_{OUT} = 50 \text{ mA}$<br>(Note 3)   | $V_{OUT} < 1.8 \text{ V}$    | -18                     | —   | +18  | —                       | —         | mV                    |
|                                |                  |   | $1.8 \text{ V} \leq V_{OUT}$ | -1.0                    | —   | +1.0   | —                       | —         | %                     |
| Bias voltage                   | $V_{BAT}$        | $V_{OUT} \leq 1.1 \text{ V}$ , $I_{OUT} = 1 \text{ mA}$   |                              | 2.5                     | —   | 5.5  | 2.5                     | 5.5       | V                     |
|                                |                  | $V_{OUT} > 1.1 \text{ V}$ , $I_{OUT} = 1 \text{ mA}$  |                              | $V_{OUT} + 1.4\text{V}$ | —   | 5.5  | $V_{OUT} + 1.4\text{V}$ | 5.5       | V                     |
| Input voltage                  | $V_{IN}$         | $I_{OUT} = 1 \text{ mA}$ ,  |                              | $V_{OUT} + 0.1\text{V}$ | —   | $V_{BAT}$  | $V_{OUT} + 0.1\text{V}$ | $V_{BAT}$ | V                     |
| Line regulation                | Reg·line         | $V_{OUT} + 0.5 \text{ V} \leq V_{IN} \leq 5.5 \text{ V}$ ,<br>$I_{OUT} = 1 \text{ mA}$  |                              | —                       | 1   | 15   | —                       | —         | mV                    |
| Load regulation                | Reg·load         | $1 \text{ mA} \leq I_{OUT} \leq 500 \text{ mA}$   |                              | —                       | 15  | 70   | —                       | —         | mV                    |
| Quiescent current              | $I_B$            | $I_{OUT} = 0 \text{ mA}$ , $V_{BAT} = 5.5 \text{ V}$<br>(Note 4)(Note 5)  |                              | —                       | 40  | —  | —                       | 68        | $\mu\text{A}$         |
|                                |                  | $I_{OUT} = 0 \text{ mA}$ , $V_{BAT} = 4.2 \text{ V}$<br>(Note 4)(Note 6)  |                              | —                       | 38  | —  | —                       | 55        |                       |
| Stand-by current               | $I_B$ (OFF)      | $V_{CT} = 0 \text{ V}$  |                              | —                       | 0.1 | —  | —                       | 2.0       | $\mu\text{A}$         |
| Control pull down current      | $I_{CT}$         | —   |                              | —                       | 0.1 | —  | —                       | —         | $\mu\text{A}$         |
| Drop-out voltage               | $V_{IN}-V_{OUT}$ | $I_{OUT} = 300 \text{ mA}$ , $V_{BAT} = 3.3 \text{ V}$<br>(Note 7)(Note 8)  |                              | —                       | 90  | —  | —                       | 130       | mV                    |
| Under voltage lockout          | $V_{UVLO}$       | $V_{IN}$ voltage  |                              | —                       | 0.5 | —  | —                       | 0.65      | V                     |
| Temperature coefficient        | $T_{CVO}$        | $-40^\circ\text{C} \leq T_{opr} \leq 85^\circ\text{C}$  |                              | —                       | 60  | —  | —                       | —         | ppm/ $^\circ\text{C}$ |
| Output noise voltage           | $V_{NO}$         | $V_{BAT} = 5.5 \text{ V}$ , $V_{IN} = V_{OUT} + 1 \text{ V}$ ,<br>$I_{OUT} = 10 \text{ mA}$ ,<br>$10 \text{ Hz} \leq f \leq 100 \text{ kHz}$ , $T_a = 25^\circ\text{C}$<br>(Note 7)                       |                              | —                       | 40  | —  | —                       | —         | $\mu\text{V}_{rms}$   |
| Ripple rejection ratio         | R.R.             | $V_{BAT} = 5.5 \text{ V}$ , $V_{IN} = V_{OUT} + 1 \text{ V}$ ,<br>$I_{OUT} = 10 \text{ mA}$ ,<br>$f = 1 \text{ kHz}$ , $V_{IN}$ Ripple = $200 \text{ mV}_{p-p}$ ,<br>$T_a = 25^\circ\text{C}$<br>(Note 7) |                              | —                       | 70  | —  | —                       | —         | dB                    |
| Control voltage (ON)           | $V_{CT}$ (ON)    | —   |                              | 1.0                     | —   | 5.5  | 1.0                     | 5.5       | V                     |
| Control voltage (OFF)          | $V_{CT}$ (OFF)   | —   |                              | 0                       | —   | 0.4  | 0                       | 0.4       | V                     |
| Output discharge on resistance | RSD              | —   |                              | —                       | 20  | —  | —                       | —         | $\Omega$              |

Note 3: Stable state with fixed  $I_{OUT}$  condition

Note 4: Except Control pull down current

Note 5: Over 2.8 V output products

Note 6: 2.8 V and under output products

Note 7: The 0.6 V output product.

Note 8:  $V_{IN}-V_{OUT} = V_{IN1} - (V_{OUT1} \times 0.98)$

$V_{OUT1}$  is the output voltage when  $V_{IN} = V_{OUT} + 0.5 \text{ V}$ .

$V_{IN1}$  is the input voltage at which the output voltage becomes 98% of  $V_{OUT1}$  after gradually decreasing the input voltage

Note 9: This parameter is guaranteed by design.

## Drop-out voltage

( $C_{IN} = 1.0 \mu\text{F}$ ,  $C_{OUT} = 2.2 \mu\text{F}$ ,  $C_{BAT} = 1.0 \mu\text{F}$ ,  $T_j = 25^\circ\text{C}$ )

| Output voltages                                 | $V_{BAT}$ input voltage   | $I_{OUT} = 300 \text{ mA}$ |      |                  | $I_{OUT} = 500 \text{ mA}$ |      |                  | Unit |
|---|---------------------------|----------------------------|------|------------------|----------------------------|------|------------------|------|
|   |                           | Min                        | Typ. | Max<br>(Note 10) | Min                        | Typ. | Max<br>(Note 10) |      |
| $0.55 \text{ V} \leq V_{OUT} < 0.7 \text{ V}$   | 3.3 V                     | —                          | 90   | 130              | —                          | 150  | 200              | mV   |
| $0.7 \text{ V} \leq V_{OUT} < 0.8 \text{ V}$    | 3.3 V                     | —                          | 90   | 140              | —                          | 150  | 210              | mV   |
| $0.8 \text{ V} \leq V_{OUT} < 0.9 \text{ V}$    | 3.3 V                     | —                          | 90   | 140              | —                          | 150  | 220              | mV   |
| $0.9 \text{ V} \leq V_{OUT} < 1.0 \text{ V}$    | 3.3 V                     | —                          | 90   | 140              | —                          | 150  | 230              | mV   |
| $1.0 \text{ V} \leq V_{OUT} < 1.2 \text{ V}$    | 3.3 V                     | —                          | 90   | 150              | —                          | 150  | 250              | mV   |
| $1.2 \text{ V} \leq V_{OUT} < 1.3 \text{ V}$    | 3.3 V                     | —                          | 140  | 170              | —                          | 230  | 270              | mV   |
| 1.3 V   | 3.3 V                     | —                          | 150  | 180              | —                          | 250  | 300              | mV   |
| 1.4 V   | 3.3 V                     | —                          | 160  | 190              | —                          | 260  | 330              | mV   |
| 1.5 V   | 3.3 V                     | —                          | 170  | 200              | —                          | 280  | 350              | mV   |
| 1.6 V   | $V_{OUT} + 1.7 \text{ V}$ | —                          | 180  | 220              | —                          | 290  | 400              | mV   |
| 1.7 V   | $V_{OUT} + 1.7 \text{ V}$ | —                          | 190  | 240              | —                          | 310  | 420              | mV   |
| $1.8 \text{ V} \leq V_{OUT} \leq 3.6 \text{ V}$ | $V_{OUT} + 1.7 \text{ V}$ | —                          | 190  | 250              | —                          | 330  | 430              | mV   |

Note 10:  $T_j = -40$  to  $85^\circ\text{C}$ . This parameter is guaranteed by design

## Application Note

### 1. Recommended Application Circuit

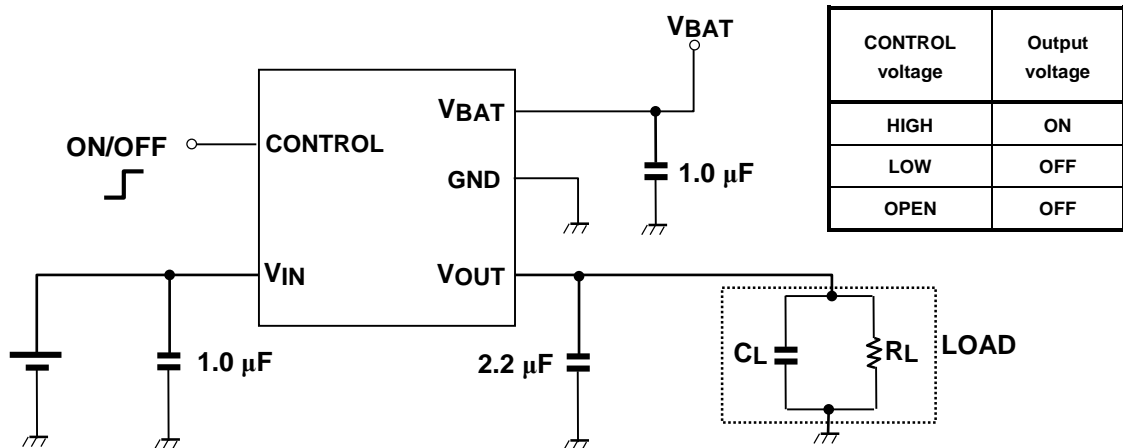

The figure above shows the recommended configuration for using a Low-Dropout regulator. Insert a capacitor at VIN , VOUT and VBAT pins for stable input/output operation. (Ceramic capacitors can be used).

### 2. Power Dissipation

Board-mounted power dissipation ratings for TCR5AM series are available in the Absolute Maximum Ratings table. Power dissipation is measured on the board condition shown below.

[The Board Condition]

Board material: Glass epoxy (FR4)

Board dimension: 40 mm x 40 mm (both sides of board), t= 1.6 mm

Metal pattern ratio: a surface approximately 50%, the reverse side approximately 50%

Through whole hall: diameter 0.5 mm x 24



**Attention in Use**

- **Output Capacitors**  
Ceramic capacitors can be used for these devices. However, because of the type of the capacitors, there might be unexpected thermal features. Please consider application condition for selecting capacitors. And Toshiba recommend the ESR of ceramic capacitor is under 10  $\Omega$ .
  
- **Mounting**  
The long distance between IC and output capacitor might affect phase assurance by impedance in wire and inductor. For stable power supply, output capacitor need to mount near IC as much as possible. Also VIN and GND pattern need to be large and make the wire impedance small as possible.
  
- **Permissible Loss**  
Please have enough design patterns for expected maximum permissible loss. And under consideration of surrounding temperature, input voltage, and output current etc, we recommend proper dissipation ratings for maximum permissible loss; in general maximum dissipation rating is 70 to 80 percent.
  
- **Over current Protection and Thermal shut down function**  
Over current protection and Thermal shut down function are designed in these products, but these are not designed to constantly ensure the suppression of the device within operation limits. Depending on the condition during actual usage, it could affect the electrical characteristic specification and reliability. Also note that if output pins and GND pins are not completely shorted out, these products might be break down.  
When using these products, please read through and understand the concept of dissipation for absolute maximum ratings from the above mention or our 'Semiconductor Reliability Handbook'. Then use these products under absolute maximum ratings in any condition. Furthermore, Toshiba recommend inserting failsafe system into the design.



Representative Typical Characteristics

Output Voltage vs. Input Voltage

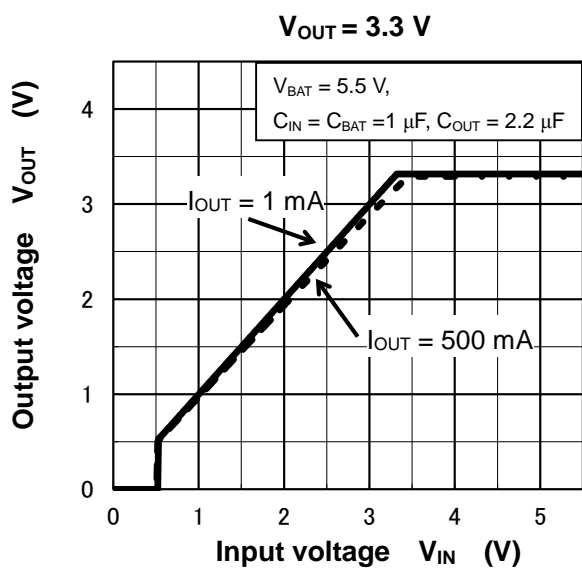
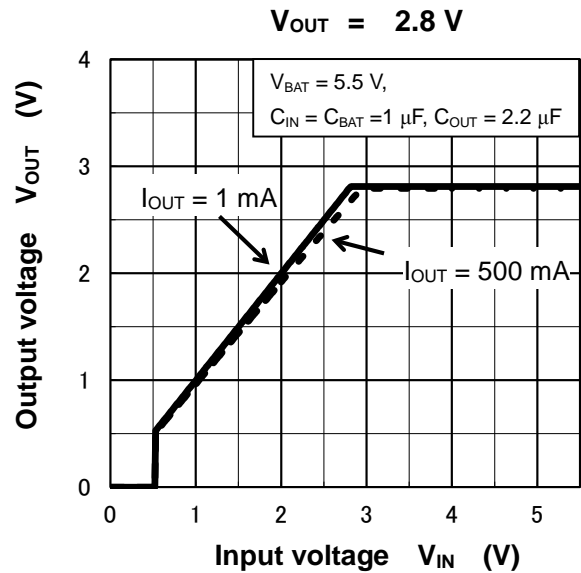
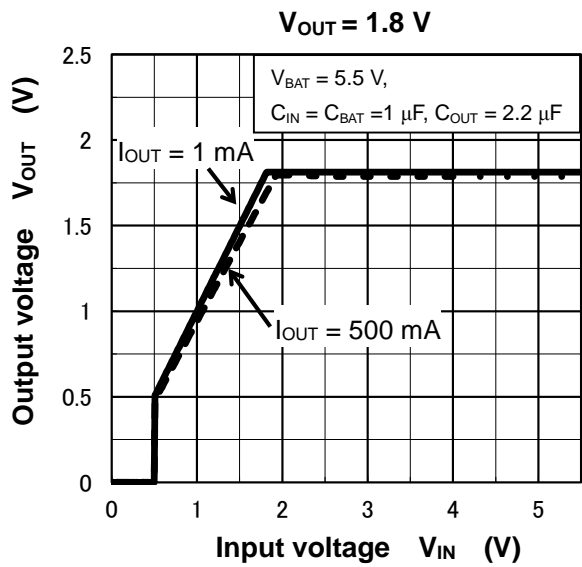
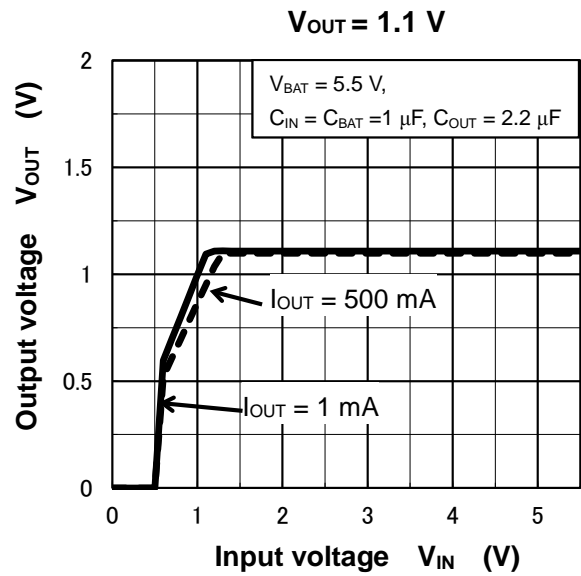
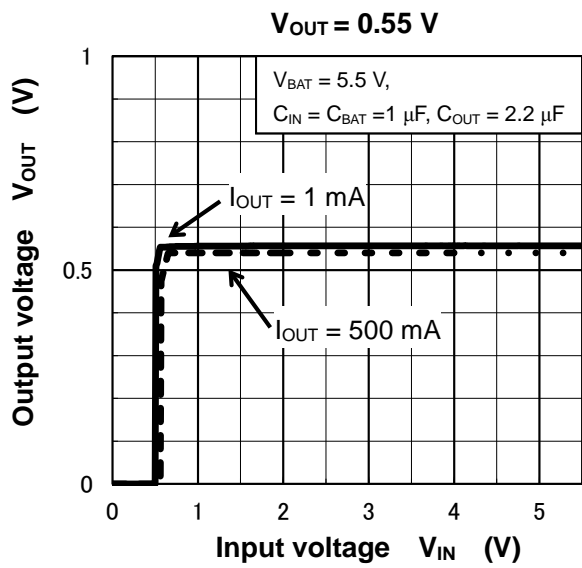

**Representative Typical Characteristics**

**Output Voltage vs. Output Current**

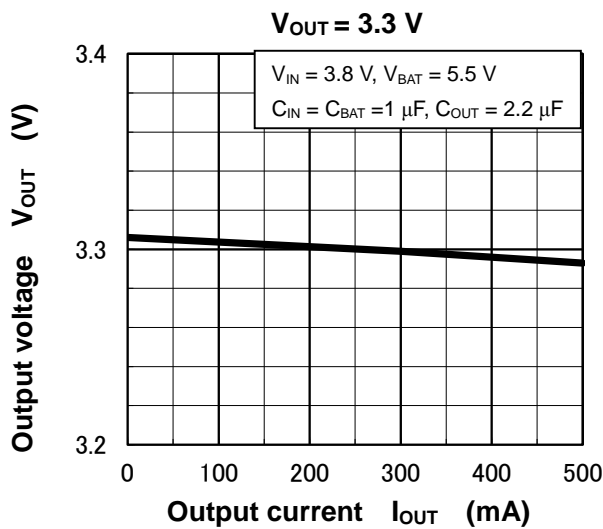
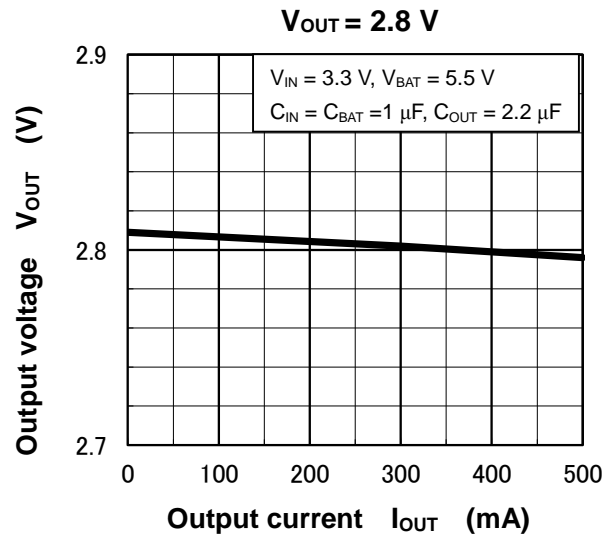
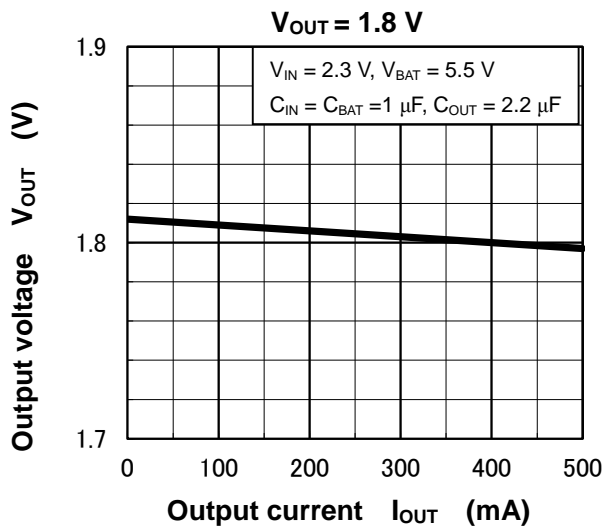
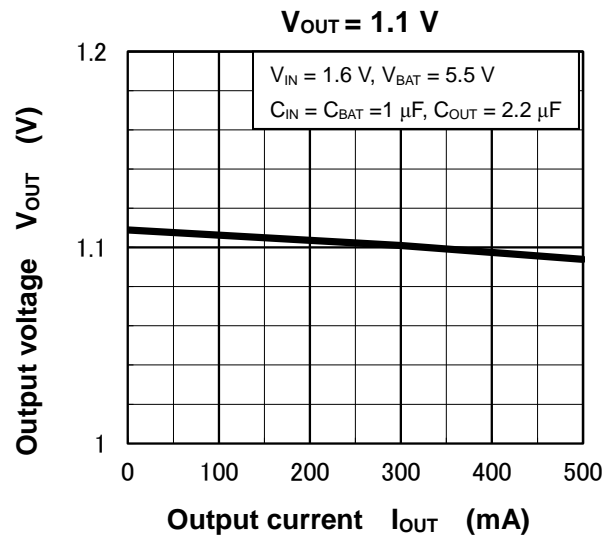
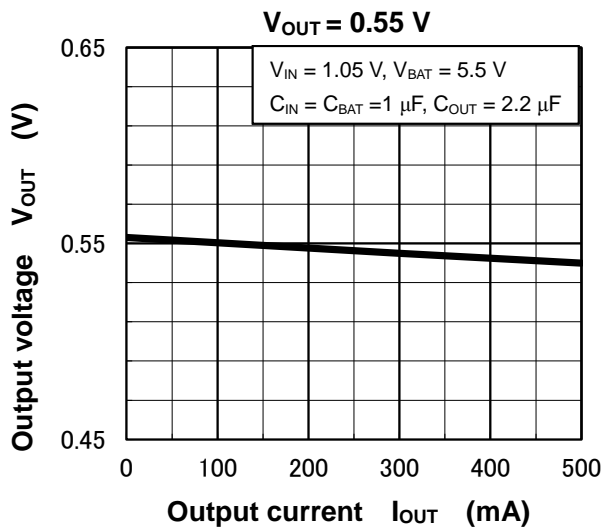

**Representative Typical Characteristics**

**Dropout Voltage vs. Output Current**

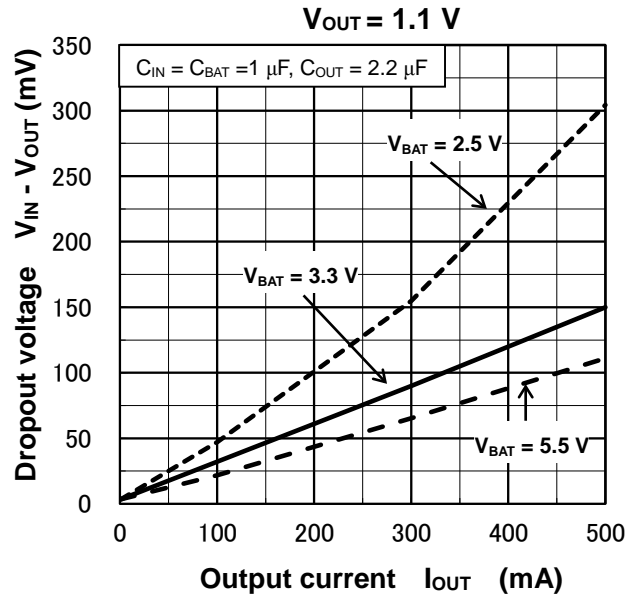
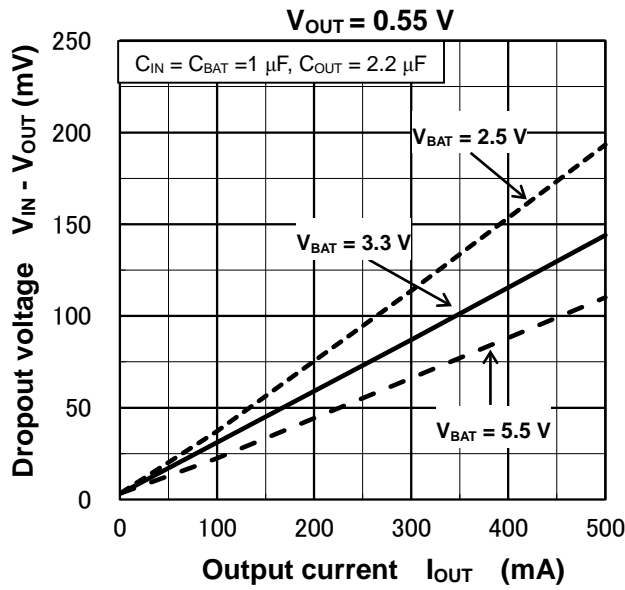

## Representative Typical Characteristics

### Quiescent Current vs. Input Voltage

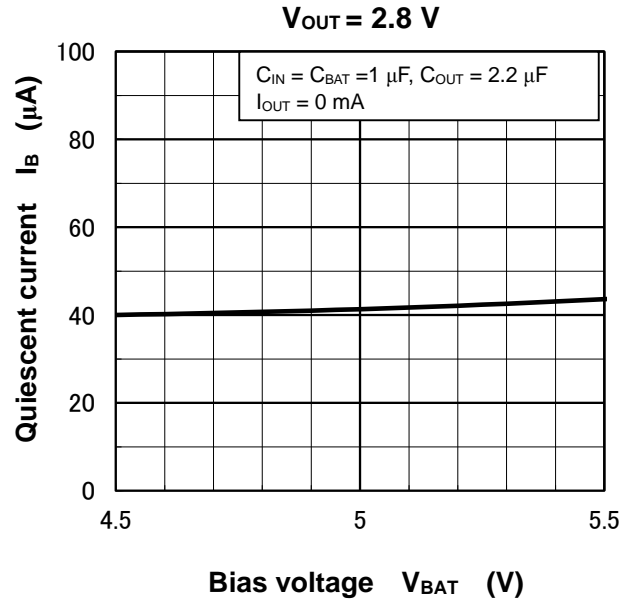
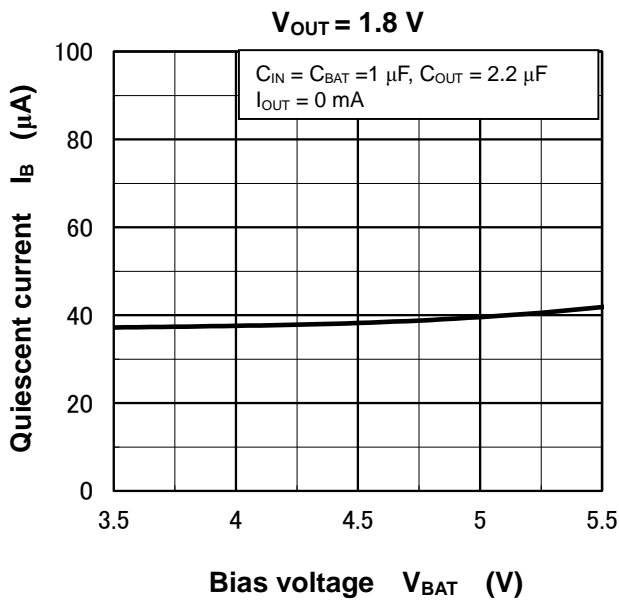

Representative Typical Characteristics

Ripple Rejection Ratio vs. Frequency



**Representative Typical Characteristics**

**Output Voltage vs. Output Current**

$V_{OUT} = 0.55\text{ V}$



$V_{OUT} = 1.1\text{ V}$

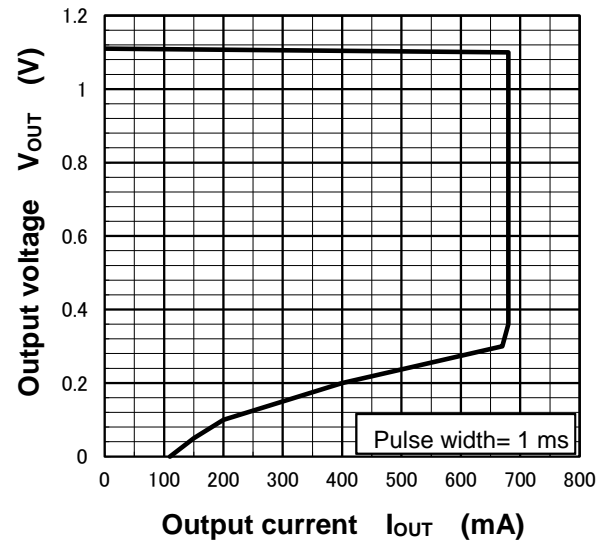

$V_{OUT} = 1.8\text{ V}$

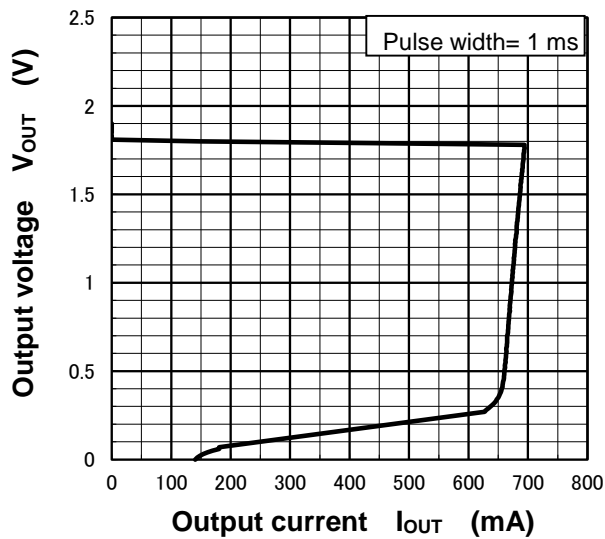

$V_{OUT} = 2.8\text{ V}$

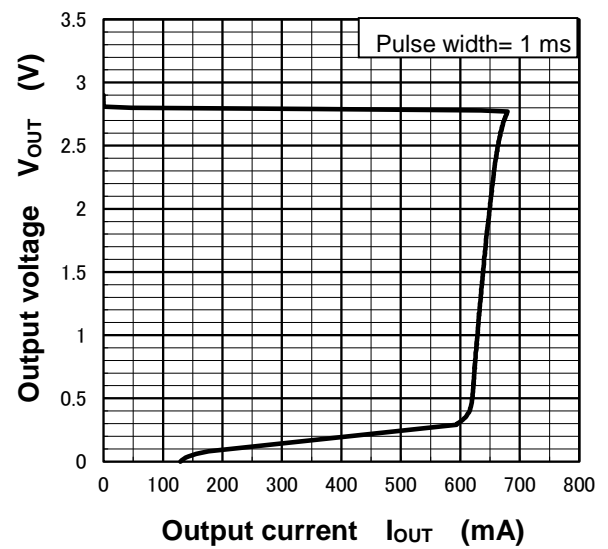

$V_{OUT} = 3.3\text{ V}$

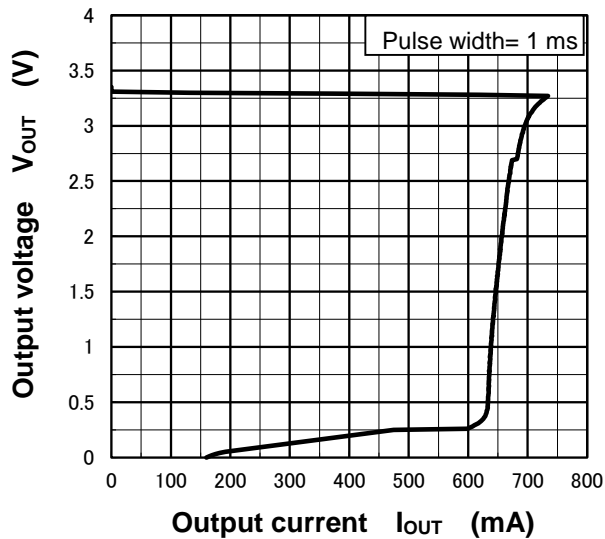

## Load Transient Response

$V_{OUT} = 1.1\text{ V}$   
 $(I_{OUT} = 1\text{ mA} \Leftrightarrow 500\text{ mA})$

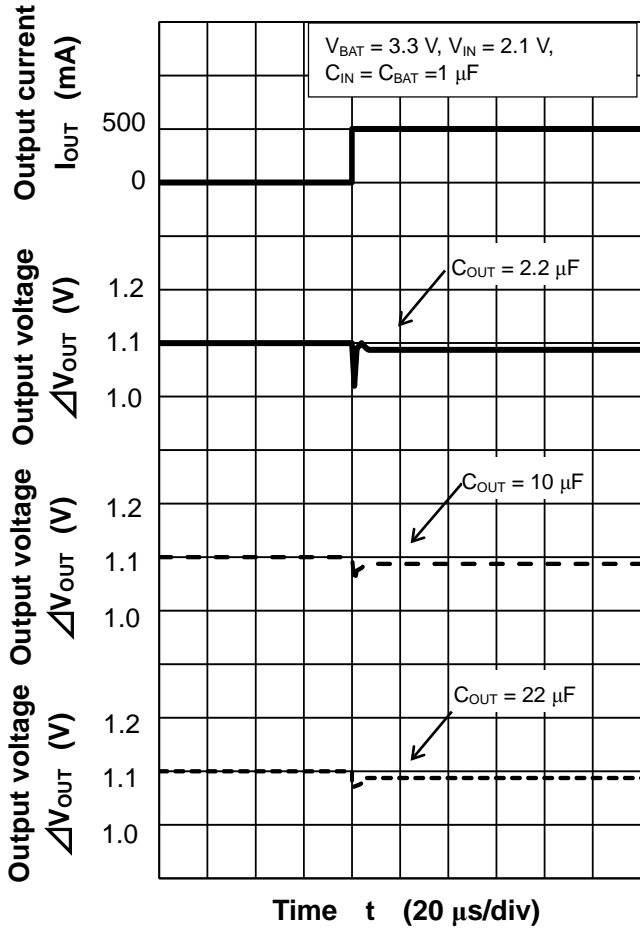

$V_{OUT} = 1.1\text{ V}$   
 $(I_{OUT} = 1\text{ mA} \Leftrightarrow 500\text{ mA})$

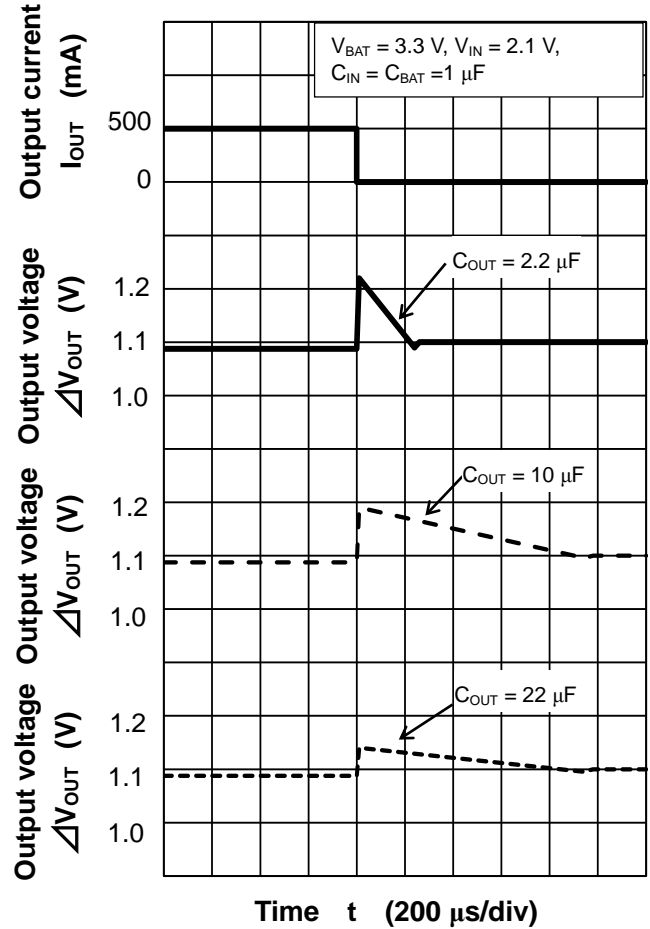

## Load Transient Response

$V_{OUT} = 3.3\text{ V}$   
 $(I_{OUT} = 1\text{ mA} \Leftrightarrow 500\text{ mA})$

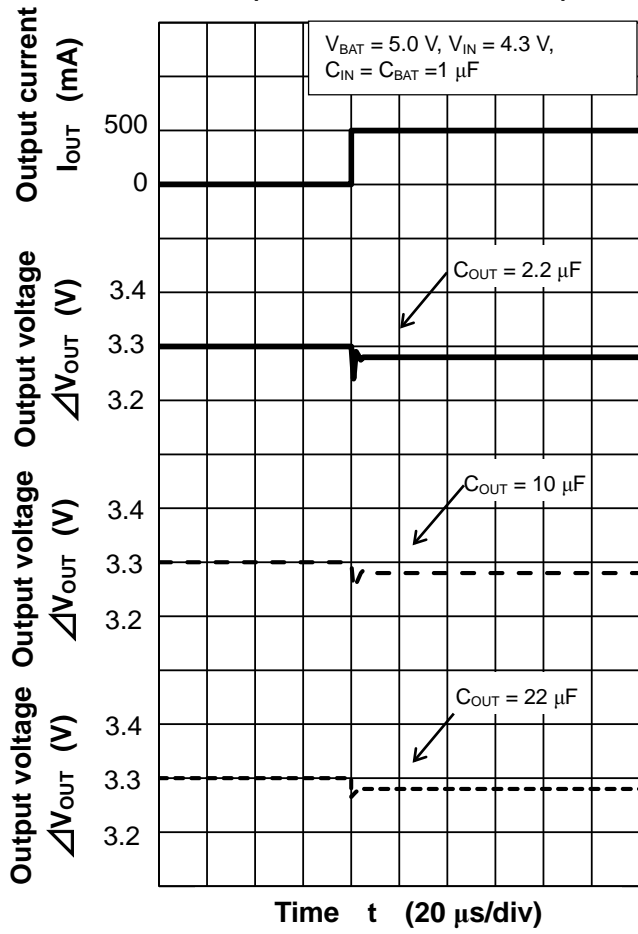

$V_{OUT} = 3.3\text{ V}$   
 $(I_{OUT} = 1\text{ mA} \Leftrightarrow 500\text{ mA})$

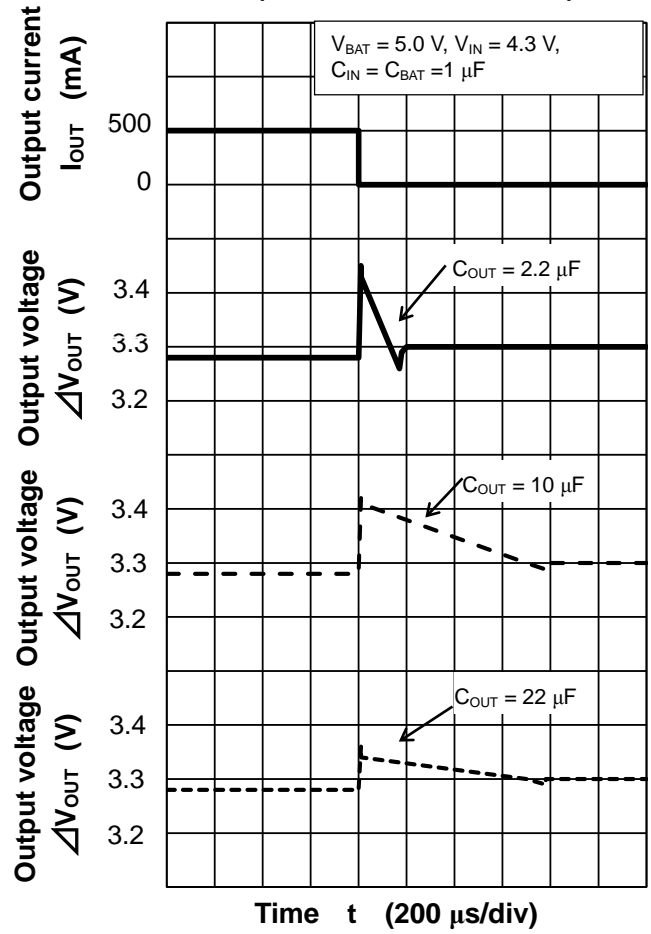



**Package Dimensions**

DFN5B

Unit: mm

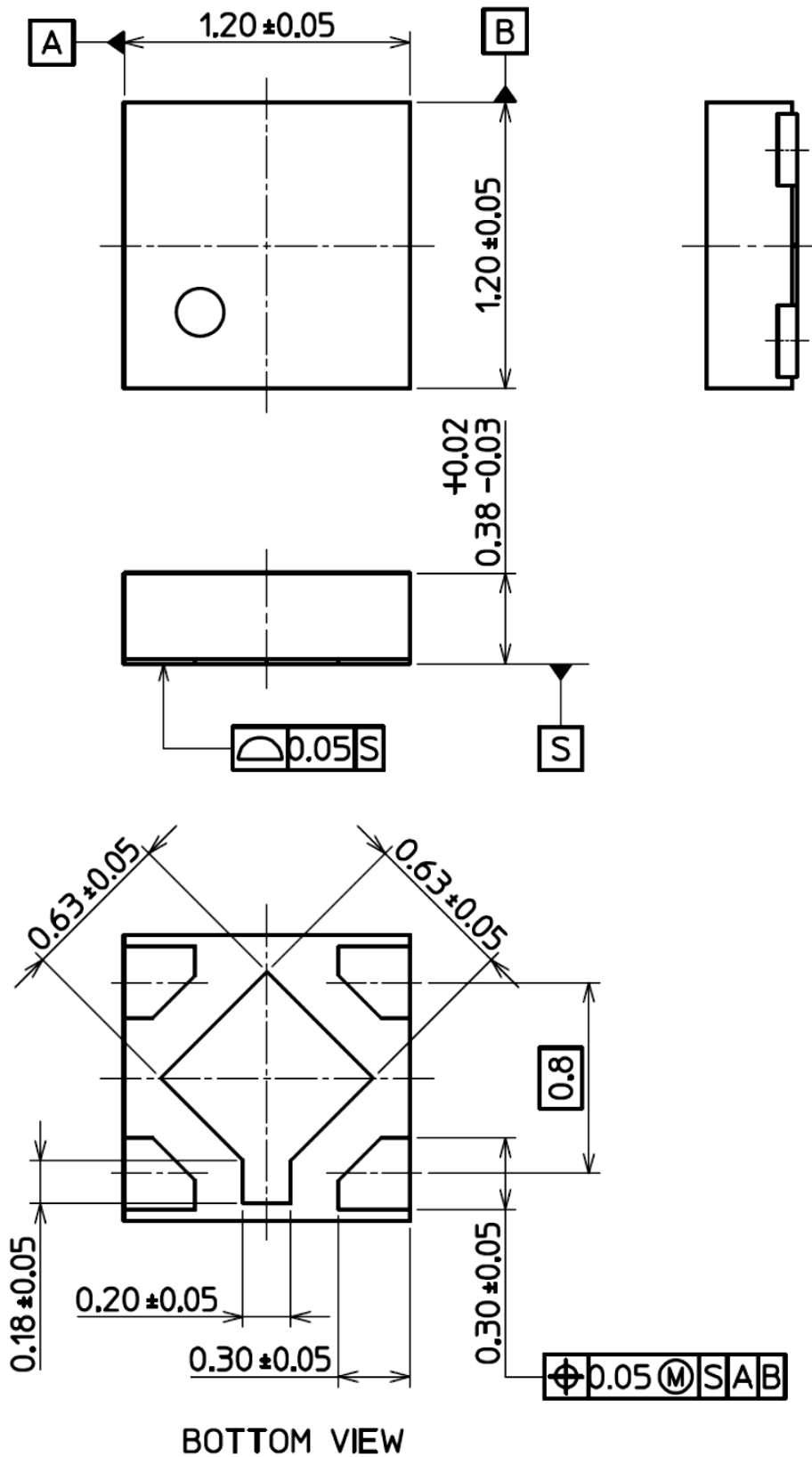

Weight : 1.4 mg ( Typ.)

Land pattern dimensions for reference only

DFN5B

Unit: mm



**RESTRICTIONS ON PRODUCT USE**

- Toshiba Corporation, and its subsidiaries and affiliates (collectively "TOSHIBA"), reserve the right to make changes to the information in this document, and related hardware, software and systems (collectively "Product") without notice.
- This document and any information herein may not be reproduced without prior written permission from TOSHIBA. Even with TOSHIBA's written permission, reproduction is permissible only if reproduction is without alteration/omission.
- Though TOSHIBA works continually to improve Product's quality and reliability, Product can malfunction or fail. Customers are responsible for complying with safety standards and for providing adequate designs and safeguards for their hardware, software and systems which minimize risk and avoid situations in which a malfunction or failure of Product could cause loss of human life, bodily injury or damage to property, including data loss or corruption. Before customers use the Product, create designs including the Product, or incorporate the Product into their own applications, customers must also refer to and comply with (a) the latest versions of all relevant TOSHIBA information, including without limitation, this document, the specifications, the data sheets and application notes for Product and the precautions and conditions set forth in the "TOSHIBA Semiconductor Reliability Handbook" and (b) the instructions for the application with which the Product will be used with or for. Customers are solely responsible for all aspects of their own product design or applications, including but not limited to (a) determining the appropriateness of the use of this Product in such design or applications; (b) evaluating and determining the applicability of any information contained in this document, or in charts, diagrams, programs, algorithms, sample application circuits, or any other referenced documents; and (c) validating all operating parameters for such designs and applications. **TOSHIBA ASSUMES NO LIABILITY FOR CUSTOMERS' PRODUCT DESIGN OR APPLICATIONS.**
- **PRODUCT IS NEITHER INTENDED NOR WARRANTED FOR USE IN EQUIPMENTS OR SYSTEMS THAT REQUIRE EXTRAORDINARILY HIGH LEVELS OF QUALITY AND/OR RELIABILITY, AND/OR A MALFUNCTION OR FAILURE OF WHICH MAY CAUSE LOSS OF HUMAN LIFE, BODILY INJURY, SERIOUS PROPERTY DAMAGE AND/OR SERIOUS PUBLIC IMPACT ("UNINTENDED USE").** Except for specific applications as expressly stated in this document, Unintended Use includes, without limitation, equipment used in nuclear facilities, equipment used in the aerospace industry, medical equipment, equipment used for automobiles, trains, ships and other transportation, traffic signaling equipment, equipment used to control combustions or explosions, safety devices, elevators and escalators, devices related to electric power, and equipment used in finance-related fields. **IF YOU USE PRODUCT FOR UNINTENDED USE, TOSHIBA ASSUMES NO LIABILITY FOR PRODUCT.** For details, please contact your TOSHIBA sales representative.
- Do not disassemble, analyze, reverse-engineer, alter, modify, translate or copy Product, whether in whole or in part.
- Product shall not be used for or incorporated into any products or systems whose manufacture, use, or sale is prohibited under any applicable laws or regulations.
- The information contained herein is presented only as guidance for Product use. No responsibility is assumed by TOSHIBA for any infringement of patents or any other intellectual property rights of third parties that may result from the use of Product. No license to any intellectual property right is granted by this document, whether express or implied, by estoppel or otherwise.
- **ABSENT A WRITTEN SIGNED AGREEMENT, EXCEPT AS PROVIDED IN THE RELEVANT TERMS AND CONDITIONS OF SALE FOR PRODUCT, AND TO THE MAXIMUM EXTENT ALLOWABLE BY LAW, TOSHIBA (1) ASSUMES NO LIABILITY WHATSOEVER, INCLUDING WITHOUT LIMITATION, INDIRECT, CONSEQUENTIAL, SPECIAL, OR INCIDENTAL DAMAGES OR LOSS, INCLUDING WITHOUT LIMITATION, LOSS OF PROFITS, LOSS OF OPPORTUNITIES, BUSINESS INTERRUPTION AND LOSS OF DATA, AND (2) DISCLAIMS ANY AND ALL EXPRESS OR IMPLIED WARRANTIES AND CONDITIONS RELATED TO SALE, USE OF PRODUCT, OR INFORMATION, INCLUDING WARRANTIES OR CONDITIONS OF MERCHANTABILITY, FITNESS FOR A PARTICULAR PURPOSE, ACCURACY OF INFORMATION, OR NONINFRINGEMENT.**
- Do not use or otherwise make available Product or related software or technology for any military purposes, including without limitation, for the design, development, use, stockpiling or manufacturing of nuclear, chemical, or biological weapons or missile technology products (mass destruction weapons). Product and related software and technology may be controlled under the applicable export laws and regulations including, without limitation, the Japanese Foreign Exchange and Foreign Trade Law and the U.S. Export Administration Regulations. Export and re-export of Product or related software or technology are strictly prohibited except in compliance with all applicable export laws and regulations.
- Please contact your TOSHIBA sales representative for details as to environmental matters such as the RoHS compatibility of Product. Please use Product in compliance with all applicable laws and regulations that regulate the inclusion or use of controlled substances, including without limitation, the EU RoHS Directive. **TOSHIBA ASSUMES NO LIABILITY FOR DAMAGES OR LOSSES OCCURRING AS A RESULT OF NONCOMPLIANCE WITH APPLICABLE LAWS AND REGULATIONS.**

# Mouser Electronics

Authorized Distributor

Click to View Pricing, Inventory, Delivery & Lifecycle Information:

[Toshiba:](#)

[TCR5AM055,LF](#)

Компания «Океан Электроники» предлагает заключение долгосрочных отношений при поставках импортных электронных компонентов на взаимовыгодных условиях!

Наши преимущества:

- Поставка оригинальных импортных электронных компонентов напрямую с производств Америки, Европы и Азии, а так же с крупнейших складов мира;
- Широкая линейка поставок активных и пассивных импортных электронных компонентов (более 30 млн. наименований);
- Поставка сложных, дефицитных, либо снятых с производства позиций;
- Оперативные сроки поставки под заказ (от 5 рабочих дней);
- Экспресс доставка в любую точку России;
- Помощь Конструкторского Отдела и консультации квалифицированных инженеров;
- Техническая поддержка проекта, помощь в подборе аналогов, поставка прототипов;
- Поставка электронных компонентов под контролем ВП;
- Система менеджмента качества сертифицирована по Международному стандарту ISO 9001;
- При необходимости вся продукция военного и аэрокосмического назначения проходит испытания и сертификацию в лаборатории (по согласованию с заказчиком);
- Поставка специализированных компонентов военного и аэрокосмического уровня качества (Xilinx, Altera, Analog Devices, Intersil, Interpoint, Microsemi, Actel, Aeroflex, Peregrine, VPT, Syfer, Eurofarad, Texas Instruments, MS Kennedy, Miteq, Cobham, E2V, MA-COM, Hittite, Mini-Circuits, General Dynamics и др.);

Компания «Океан Электроники» является официальным дистрибьютором и эксклюзивным представителем в России одного из крупнейших производителей разъемов военного и аэрокосмического назначения «JONHON», а так же официальным дистрибьютором и эксклюзивным представителем в России производителя высокотехнологичных и надежных решений для передачи СВЧ сигналов «FORSTAR».



## JONHON

«JONHON» (основан в 1970 г.)

Разъемы специального, военного и аэрокосмического назначения:

(Применяются в военной, авиационной, аэрокосмической, морской, железнодорожной, горно- и нефтедобывающей отраслях промышленности)

«FORSTAR» (основан в 1998 г.)

ВЧ соединители, коаксиальные кабели, кабельные сборки и микроволновые компоненты:

(Применяются в телекоммуникациях гражданского и специального назначения, в средствах связи, РЛС, а так же военной, авиационной и аэрокосмической отраслях промышленности).



Телефон: 8 (812) 309-75-97 (многоканальный)

Факс: 8 (812) 320-03-32

Электронная почта: [ocean@oceanchips.ru](mailto:ocean@oceanchips.ru)

Web: <http://oceanchips.ru/>

Адрес: 198099, г. Санкт-Петербург, ул. Калинина, д. 2, корп. 4, лит. А