

Accessories Miniature Relay PT

- Easy replacement of relays on a densely packed DIN rail
- No reduction of protection class or creepage/clearance with plastic retainer
- Plug-in indicator- and protection modules
- Retainer clip with ejection function for relays of 29 mm height
- DIN-rail sockets and accessories: RoHS compliant (Directive 2002/95/EC)



F0263-F

Premium socket with screwless terminals for DIN rail mounting

PT 78 74P Premium socket, logical terminal arrangement, 4 pole
PT 78 72P Premium socket, logical terminal arrangement, 2 pole

- PT 2/4 pole 6/12 A
- Screwless Clamps
- Mounting of solid wires without tool
- Double Clamps per terminal
- Jumper links for interconnection
- Open coil circuit for active modules
- Logical terminal arrangement



F0300-B

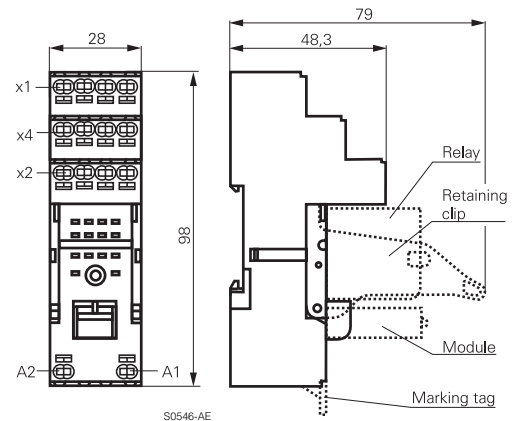

S0546-AE

Approvals

VDE REG.-Nr. 115719, c **UL** us E135149

Technical data	2-pole	4-pole
Rated voltage / max. switching voltage AC	240 / 400 VAC	240 VAC
Rated current	12 A	6 A
Limiting continuous current	see derating curve	
Dielectric strength coil-contact circuit	2500 V _{rms}	2500 V _{rms}
open contact circuit	1200 V _{rms}	1200 V _{rms}
adjacent contact circuits	2500 V _{rms}	2000 V _{rms}
Clearance / creepage coil-contact circuit	≥ 4/4 mm	≥ 4/4 mm
adjacent contact circuits	≥ 3.5/9.5 mm	≥ 1.8/3.5 mm
Material group of insulation parts	IIIa	
Insulation to IEC 60664-1		
Type of insulation coil-contact circuit	basic	
open contact circuit	functional	
adjacent contact circuits	basic	
Rated insulation voltage	250 V	
Pollution degree	2 ¹⁾	
Rated voltage system	230 / 400 V	
Overvoltage category	III	

Derating curve PT787.P

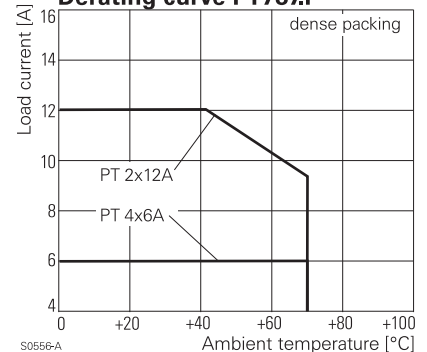

¹⁾ with inserted relay pollution degree 1 in region of contact pins / socket inlets.

Accessories Miniature Relay PT (Continued)

Technical data (Continued)	2-pole	4-pole
RoHS - Directive 2002/95/EC	compliant	
Ambient temperature range for mounting/handling in operation	-25...+70°C -40...+70°C	
Terminals	screwless	
Wire strip length	12 mm	
Wire cross section		
solid wire	1 x 0.75/1/1.5 mm ² 2 x 0.75/1 mm ² 2 x 1.5 mm ²	
with standard isolation (no oversize isolation)	2 x 1.5 mm ²	
stranded wire		
without bootlace crimp	1 x 0.75/1/1.5 mm ² 2 x 0.75/1 mm ² 2 x 1.5 mm ²	
without bootlace crimp with standard isolation	2 x 1.5 mm ²	
with bootlace crimp	1 x 0.75/1 mm ² 2 x 0.75 mm ²	
with bootlace crimp without isolation or min 18 mm long	1 x 1.5 mm ²	
For stranded wires with braids 0.05 mm or smaller the use of bootlace crimps is recommended. When using stranded wires without bootlace crimp the clamp must be opened during insertion.		
Insertion cycles	A (10)	
Max. Insertion Force total	100 N	
Mounting distance	≥ 0, dense packing	
Weight	44 g	60 g
Packaging unit	10 pcs	

Socket with screwless terminals for DIN rail mounting		
Type		Part Number
PT 7872P	Premium socket, logical terminal arrangement Socket with screwless terminals 2 pole	1860100-1
PT 7874P	Premium socket, logical terminal arrangement Socket with screwless terminals 4 pole	1860000-1

Accessories for PT 78 72P, PT 78 74P		
Type		Part Number
PT 17 021	Plastic retaining clip, relay height 29 mm	2-1415526-1
PT 28 800	Metal retaining clip PT, relay height 29 mm	5-1419111-9
PT 17 040	Marking tag	6-1415037-1
PT 17 0P1	Jumper link, max load 12 A	1860214-1

How to use, Precautions

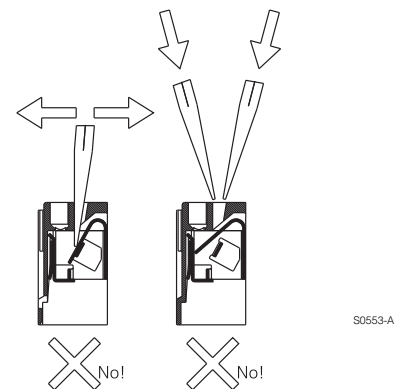
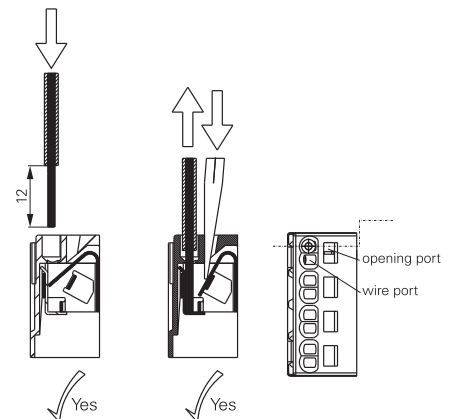
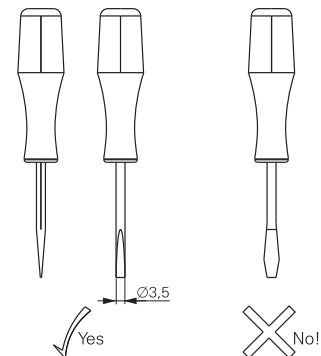

Jumper link

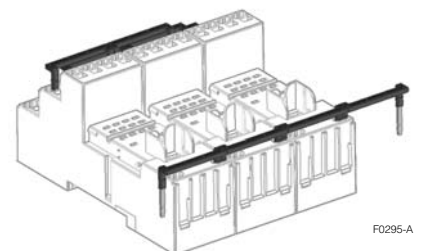

When connecting more than 2 poles with staggered jumper bars the lower bars need to be stripped and shortened to an appropriate length to enable correct fitting.

Accessories Miniature Relay PT (Continued)

PT DIN-rail socket with screw type terminals PT 78 722 / PT 78 742

- Socket with logical arrangement of control/load terminals
- High quality rising clamp terminals
- Captive combination terminal screws
- Second A2 for easier looping
- Jumper bars for interconnection



F0264-C

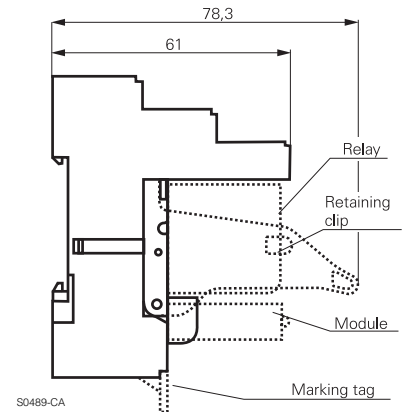
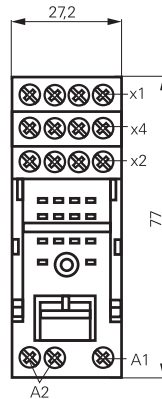

S0489-CA

Approvals

VDE REG.-Nr. 115719, cULus E135149

Technical data	2-pole	4-pole
Rated voltage / max. switching voltage AC	240 / 400 VAC	240 VAC
Rated current	12 A	6 A
Limiting continuous current	see derating curve	
Dielectric strength coil-contact circuit	2500 V _{rms}	2500 V _{rms}
open contact circuit	1200 V _{rms}	1200 V _{rms}
adjacent contact circuits	2500 V _{rms}	2000 V _{rms}
Clearance / creepage coil-contact circuit	≥ 4 / 4 mm	≥ 4 / 4 mm
adjacent contact circuits	≥ 3.5 / 9.5 mm	≥ 1.8 / 3.5 mm
Material group of insulation parts	IIIa	
Insulation to IEC 60664-1		
Type of insulation coil-contact circuit	basic	
open contact circuit	functional	
adjacent contact circuits	basic	
Rated insulation voltage	250 V	
Pollution degree	2 ¹⁾	
Rated voltage system	230 / 400 V	
Overvoltage category	III	
RoHS - Directive 2002/95/EC	compliant	
Ambient temperature range	-40...+70°C	
Terminals	screw	
Terminal screw torque acc. IEC 61984	0.5 Nm	
max.	0.7 Nm	
Wire cross section		
single wire	2 x 2.5 mm ²	
fine wire	2 x 2.5 mm ²	
with bootlace crimp (DIN 46228/1)	2 x 1.5 mm ²	
Insertion cycles	A (10)	
Max. Insertion Force total	100 N	
Mounting distance	≥ 0, dense packing	
Weight	44 g	60 g
Packaging unit	10 pcs	

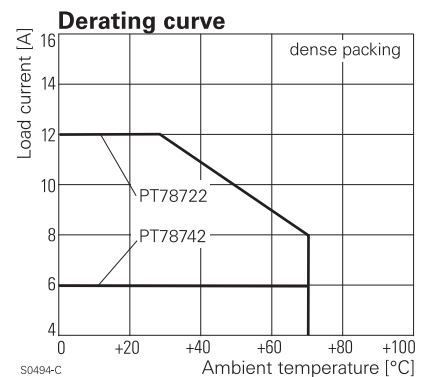

S0494-C

¹⁾ with inserted relay pollution degree 1 in region of contact pins / socket inlets.

Accessories Miniature Relay PT (Continued)

DIN-rail socket with screw type terminals, In/Out arrangement

Type		Part Number
PT 78 722	DIN-rail socket with screw type terminals, In/Out arrangement 2 pole	1415526-1
PT 78 742	DIN-rail socket with screw type terminals, In/Out arrangement 4 pole	1-1415526-1

Accessories for PT 78 722, PT 78 742

Type		Part Number
PT 17 021	Plastic retaining clip, relay height 29 mm	2-1415526-1
PT 28 800	Metal retaining clip PT, relay height 29 mm	5-1419111-9
PT 17 040	Marking tag	6-1415037-1
PT 17 0R6	Jumper bar, max load 12 A for connection of up to 6 PT sockets	1860517-5

Jumper bar

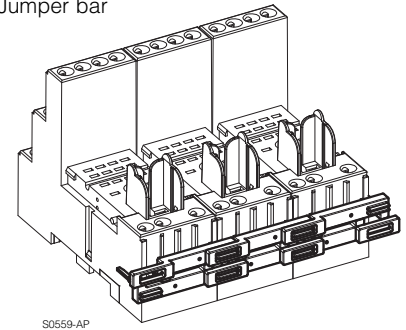

PT DIN-rail socket with screw type terminals PT 78 720/730/740/741



F0234-C

S0427-DB

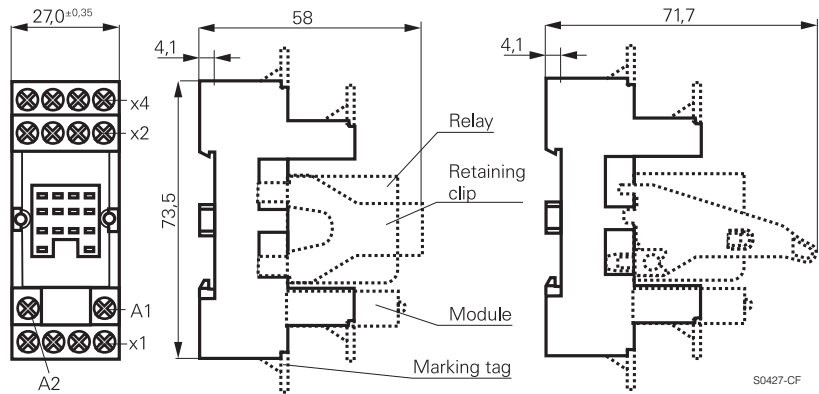

S0427-CF

Approvals

VDE REG.-Nr. 115719, cULus E135149

Technical data

	2-pole	3-pole	4-pole
Rated voltage / max. switching voltage AC		240 / 400 VAC	
Rated current	12 A	10 A	6 A
Limiting continuous current	see derating curve		
Dielectric strength coil-contact circuit	2500 V _{rms}	2500 V _{rms}	2500 V _{rms}
open contact circuit	1200 V _{rms}	1200 V _{rms}	1200 V _{rms}
adjacent contact circuits	2500 V _{rms}	2500 V _{rms}	2000 V _{rms}
Clearance / creepage coil-contact circuit	≥ 4/4 mm	≥ 4/4 mm	≥ 4/4 mm
adjacent cont. circuits	≥ 3.5/9.5 mm	≥ 2.6/3.5 mm	≥ 1.8/3.5 mm
Material group of insulation parts	IIIa		
Insulation to IEC 60664-1			
Type of insulation coil-contact circuit	basic	basic	basic
open contact circuit	functional	functional	functional
adjacent contact circuits	basic	basic	functional
Rated insulation voltage	250 V		
Pollution degree	2		
Rated voltage system	230 / 400 V		
Overvoltage category	III		
RoHS - Directive 2002/95/EC	compliant		
Ambient temperature range	-40...+70°C		
Terminals	screw		
Terminal screw torque acc. IEC 61984	0.5 Nm		
max.	0.7 Nm		
Wire cross section			
single wire	2 x 2.5 mm ²		
fine wire	2 x 2.5 mm ²		
with bootlace crimp (DIN 46228/1)	2 x 1.5 mm ²		

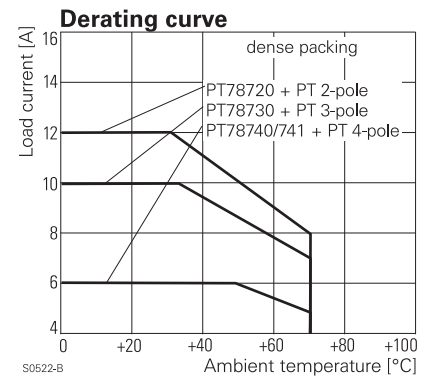

S0522-B

Accessories Miniature Relay PT (Continued)

Technical data (Continued)	2-pole	3-pole	4-pole
Insertion cycles		A (10)	
Max. Insertion Force total		100 N	
Mounting distance	≥ 0, dense packing		
Weight	41 g	48 g	55 g
Packaging unit	10 pcs		

DIN-rail socket with screw type terminals

Type		Part Number
PT 78 720	DIN-rail socket with screw type terminals, 2 pole	6-1415034-1
PT 78 730	DIN-rail socket with screw type terminals, 3 pole	9-1415071-1
PT 78 740	DIN-rail socket with screw type terminals, 4 pole	4-1415033-1
PT 78 741	DIN-rail socket with screw type terminals, 4 pole package with protection diode module A1+, A2-	5-1415034-1

Accessories for PT 78 720, PT 78 730, PT 78 740, PT 78 741

Type		Part Number
PT 17 016	Plastic retaining clip PT, relay height 29 mm	5-1415037-1
PT 17 024	Plastic retaining clip PT with ejecting function, relay height 29 mm	1816124-1
PT 28 800	Metal retaining clip PT, relay height 29 mm	5-1419111-9
PT 17 040	Marking tag	6-1415037-1
PT 17 0R6	Jumper bar, max load 12 A for connection of up to 6 PT sockets	1860517-5

LED- and Protection Modules for PT 78 72P, PT 78 74P, PT 78 722, PT 78 742, PT 78 720, PT 78 730, PT 78 740

Easy insertion of module into the socket
Wiring in parallel to the coil

Type		Part Number
PTM T0 0A0	EM09 Protection diode (standard, A1+, A2-)	9-1415036-1
PTM T0 0L0	EM01 Protection diode (A1-, A2+)	1415037-1
PTM U0 524	EM02 RC-network 6...60 VAC	1-1415037-1
PTM U0 730	EM03 RC-network 110...230 VAC	2-1415037-1
PTM V0 524	EM04 Varistor 24 VAC	3-1415037-1
PTM V0 615	EM13 Varistor 115 VAC	6-1415365-1
PTM V0 730	EM05 Varistor 230 VAC	4-1415037-1
PTM D0 730	EM31 Residual current bypass RC 110...230 VAC	1415037-2
PTM R0 730	EM29 Residual current bypass resistor 110...230 VAC	1-1415539-2

LED

PTM L0 024	EM18 red LED 6...24 VDC w. prot.diode (std, A1+, A2-)	5-1415036-1
PTM G0 024	EM12 green LED 6...24 VDC w. prot.diode (std, A1+, A2-)	2-1415036-1
PTM L1 024	EM08 red LED 6...24 VDC w. prot. diode (A1-, A2+)	8-1415036-1
PTM L0 060	EM16 red LED 24...60 VDC w. prot.diode (std, A1+, A2-)	5-1415539-3
PTM G0 060	EM25 green LED 24...60 VDC w. prot.diode (std, A1+, A2-)	7-1415539-7
PTM L0 110	EM19 red LED 60...110 VDC w. prot. diode (A1+, A2-)	2-1415392-1
PTM G0 110	EM26 green LED 60...110 VDC w. prot diode (A1+, A2-)	1-1415539-7
PTM L0 220	EM27 red LED 110...220 VDC w. prot. diode (A1+, A2-)	1-1415539-4
PTM G0 220	EM28 green LED 110...220 VDC w. prot diode (A1+, A2-)	1-1415539-6
PTM L0 524	EM07 red LED 6...24 VDC/VAC	6-1415036-1
PTM G0 524	EM11 green LED 6...24 VDC/VAC	3-1415036-1
PTM L0 560	EM14 red LED 24...60 VDC/VAC	1-1415539-3
PTM G0 560	EM30 green LED 24...60 VDC/VAC	1-1415539-5
PTM L0 730	EM06 red LED 110...230 VAC	7-1415036-1
PTM G0 730	EM10 green LED 110...230 VAC	4-1415036-1

Relay Packages

Complete packages consisting of a relay mounted on a socket: see Relay Package PT

PT17 016

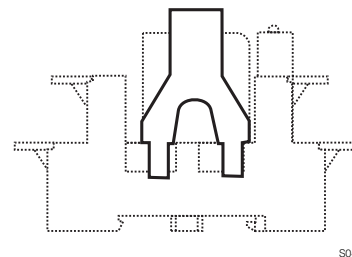

S0427-CH

PT17 024

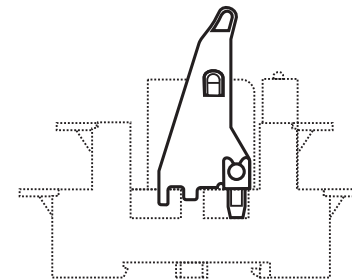

S0427-CI

Marking tags

- White marking area 28 x 6 mm
- Snaps on socket in up to 4 positions



F0231-A



F0232-A

Accessories Miniature Relay PT (Continued)

PT sockets for PCB mount and with solder terminals

PT 78 600, socket with solder terminals, 4-pole



F0132-A

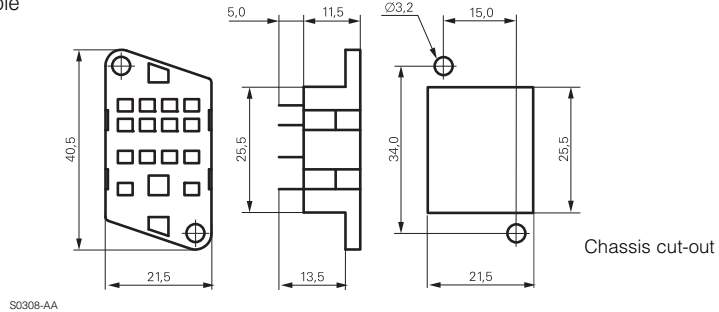

Chassis cut-out

PT 78 602, PT 78 603, PT 78 604, socket with PCB terminals, 2-, 3- and 4-pole



F0133-A

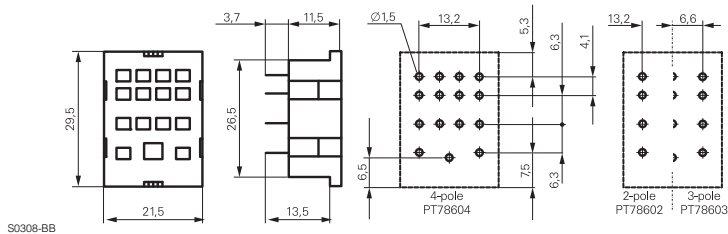

2-pole PT78602 3-pole PT78603

PT 78 601, socket with solder terminals, 4-pole



F0134-A

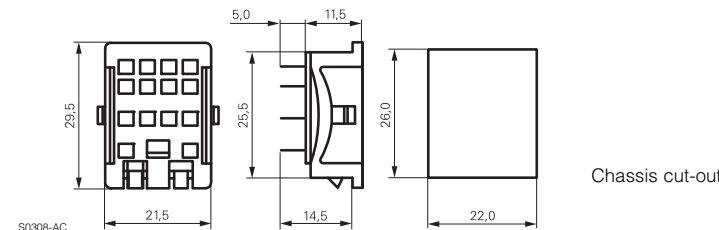

Chassis cut-out

Technical data	2-pole	3-pole	4-pole
Rated voltage / max. switching voltage AC		240 / 400 VAC	
Rated current	12 A	10 A	6 A
Dielectric strength coil-contact circuit	2500 V _{rms}	2500 V _{rms}	2500 V _{rms}
open contact circuit	1200 V _{rms}	1200 V _{rms}	1200 V _{rms}
adjacent contact circuits	2500 V _{rms}	2500 V _{rms}	2000 V _{rms}
Clearance / creepage coil-contact circuit	≥ 4/4 mm	≥ 4/4 mm	≥ 4/4 mm
adjacent cont. circuits	≥ 3.5/9.5 mm	≥ 2.6/3.5 mm	≥ 1.8/3.5 mm
Material group of insulation parts	IIIa		
Insulation to IEC 60664-1			
Type of insulation coil-contact circuit	basic	basic	basic
open contact circuit	functional	functional	functional
adjacent contact circuits	basic	basic	functional
Rated insulation voltage	250 V		
Pollution degree	2		
Rated voltage system	230 / 400 V		
Overtoltage category	III		

Accessories Miniature Relay PT (Continued)

Technical data (Continued)	2-pole	3-pole	4-pole
RoHS - Directive 2002/95/EC	compliant as per product date code 0517		
Ambient temperature range	-40...+80°C		
Terminals	pcb, solder terminals		
Insertion cycles	A (10)		
Max. Insertion Force total	100 N		
Mounting distance	≥ 0, dense packing		
Resistance to soldering heat	270°C / 10 s		
Weight	6 g	7 g	7 g
Packaging unit	25 pcs		

PT sockets

Type	Part Number
PT 78 600 Socket with solder terminals, 4 pole	4-1415043-1
PT 78 602 Socket with PCB terminals, 2 pole	5-1415043-1
PT 78 603 Socket with PCB terminals, 3 pole	1393162-5
PT 78 604 Socket with PCB terminals, 4 pole	3-1415043-1
PT 78 601 Socket with solder terminals, 4 pole	6-1415043-1

Accessories for PT 78 600, PT 78 601, PT 78 602, PT 78 603, PT 78 604

Type	Part Number
PT 28 802 Metal retaining clip PT, relay height 29 mm	1393162-1

Компания «Океан Электроники» предлагает заключение долгосрочных отношений при поставках импортных электронных компонентов на взаимовыгодных условиях!

Наши преимущества:

- Поставка оригинальных импортных электронных компонентов напрямую с производств Америки, Европы и Азии, а так же с крупнейших складов мира;
- Широкая линейка поставок активных и пассивных импортных электронных компонентов (более 30 млн. наименований);
- Поставка сложных, дефицитных, либо снятых с производства позиций;
- Оперативные сроки поставки под заказ (от 5 рабочих дней);
- Экспресс доставка в любую точку России;
- Помощь Конструкторского Отдела и консультации квалифицированных инженеров;
- Техническая поддержка проекта, помощь в подборе аналогов, поставка прототипов;
- Поставка электронных компонентов под контролем ВП;
- Система менеджмента качества сертифицирована по Международному стандарту ISO 9001;
- При необходимости вся продукция военного и аэрокосмического назначения проходит испытания и сертификацию в лаборатории (по согласованию с заказчиком);
- Поставка специализированных компонентов военного и аэрокосмического уровня качества (Xilinx, Altera, Analog Devices, Intersil, Interpoint, Microsemi, Actel, Aeroflex, Peregrine, VPT, Syfer, Eurofarad, Texas Instruments, MS Kennedy, Miteq, Cobham, E2V, MA-COM, Hittite, Mini-Circuits, General Dynamics и др.);

Компания «Океан Электроники» является официальным дистрибьютором и эксклюзивным представителем в России одного из крупнейших производителей разъемов военного и аэрокосмического назначения «JONHON», а так же официальным дистрибьютором и эксклюзивным представителем в России производителя высокотехнологичных и надежных решений для передачи СВЧ сигналов «FORSTAR».



JONHON

«JONHON» (основан в 1970 г.)

Разъемы специального, военного и аэрокосмического назначения:

(Применяются в военной, авиационной, аэрокосмической, морской, железнодорожной, горно- и нефтедобывающей отраслях промышленности)

«FORSTAR» (основан в 1998 г.)

ВЧ соединители, коаксиальные кабели, кабельные сборки и микроволновые компоненты:

(Применяются в телекоммуникациях гражданского и специального назначения, в средствах связи, РЛС, а так же военной, авиационной и аэрокосмической отраслях промышленности).



Телефон: 8 (812) 309-75-97 (многоканальный)

Факс: 8 (812) 320-03-32

Электронная почта: ocean@oceanchips.ru

Web: <http://oceanchips.ru/>

Адрес: 198099, г. Санкт-Петербург, ул. Калинина, д. 2, корп. 4, лит. А