

Part Number*	Relay Description
KA00HF	2 A, 250 Vrms, AC Solid-State Relay
KA58HF	2 A, 250 Vrms, AC Solid-State Relay with Thermal Protection and Thermal TRIP Status
LA00HL	7.5 A, 250 Vrms, AC Solid-State Relay
LA58HL	7.5 A, 250 Vrms, AC Solid-State Relay with Thermal Protection and Thermal TRIP Status

\* The Y suffix denotes parameters tested to MIL-PRF-28750 test methods. The W suffix denotes parameters tested to Teledyne specifications.

**ELECTRICAL SPECIFICATIONS**

(-55°C TO +110°C UNLESS OTHERWISE SPECIFIED)

**INPUT (CONTROL) CHARACTERISTICS**

2 Terminal Configuration (See Fig. 1)	Min	Max	Units
Input Voltage (See note 2)	3.8	32	Vdc
Input Current (See Figure 1)			
$V_{IN} = 5$ Vdc		15	mA dc
Turn-Off Voltage (Guaranteed Off)		1.5	Vdc
Turn-On Voltage (Guaranteed On)	3.8		Vdc
Reverse Voltage Protection		-32	Vdc

**INPUT (CONTROL) CHARACTERISTICS**

3 Terminal Configuration (See Fig. 1)	Min	Max	Units
Bias Voltage (See note 2)	3.8	32	Vdc
Bias Current ( $V_{IN} = 32$ Vdc)		16	mA
Control Voltage Range	0	18	Vdc
Control Current (at 5 Vdc)		250	$\mu$ A dc
Turn-On Control Voltage		0.3	Vdc
Turn-Off Control Voltage	3.2		Vdc

**OUTPUT (LOAD) SPECIFICATIONS**

	Min	Max	Units
Load Voltage	20	250	Vrms
Frequency Range	40	440	Hz
Continuous Load Current (See Figure 3)			
KA and LA without Heat Sink		2.0	Arms
LA with Heat Sink		7.5	Arms
Output Voltage Drop		1.2	Vrms

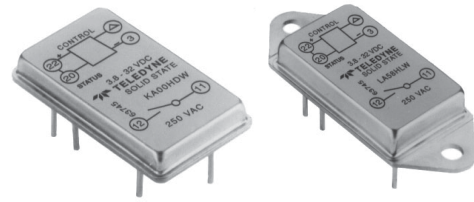

**FEATURES/BENEFITS**

- Available with thermal protection and thermal TRIP status: Provides self-protection from thermal runaway conditions and indicates protection state for system BIT.
- Optical Isolation: Isolates control elements from load transients with reduced EMI.
- Fully Floating Output: Eliminates ground potential loops and allows the output to sink or source current.
- Buffered Control: Relay can be controlled directly from TTL or CMOS logic circuits.
- Integral Snubber Circuit: Enhances dV/dt capability while minimizing EMI.

**DESCRIPTION**

The Series KA/LA solid-state relays (SSRs) is designed for use in AC power switching applications where safety and reliability are primary concerns. These SSRs are rated for load voltages up to 250 Vrms from 40 to 440 Hz and are ideal for resistive and reactive loads with power factors as low as 0.2. Inverse parallel SCRs are configured for zero voltage turn on. Optical isolation to 1250 Vrms between the control (input) and load (output) allows the load to be safely controlled by logic circuitry. The KA/LA series is available with thermal protection and thermal TRIP status. In case of a thermal runaway condition, the SSR will shut down the output switch and latch off until the input is reset and the junction temperature returns to a safe level. When the output does latch off, the TRIP status line will yield a logic level output indicating the protection state of the SSR. This feature provides the user with failure mode indication while enhancing the system diagnostic capability. These SSRs are available to the Y screening level of MIL-PRF-28750 and are packaged in low-profile hermetically sealed cases.

**OUTPUT (LOAD) SPECIFICATIONS**

	Min	Max	Units
Off-State Leakage Current (250 Vac, 400 Hz)		10	mA
Turn-On Time		1/2	Cycle
Turn-Off Time		1	Cycle
Transient Voltage (5 sec, 25°C)		±500	V pk
Zero Voltage Turn-On Point		±15	V pk
dv/dt	100		V/μs
Surge Current	MIL-PRF-28750		
Load Power Factor	0.2		
Insulation Resistance @ 500 Vdc	10 <sup>9</sup>		Ohm
Input to Output Capacitance		15	pF
Dielectric Withstanding Voltage (60Hz)	1250		Vrms
Junction Temperature at Rated Current (T <sub>J</sub> Max)	125		°C
Thermal Resistance Junction to Ambient (θ <sub>JA</sub> )	30		°C/W
Thermal Resistance Junction to Case (θ <sub>JC</sub> )	5		°C/W

**BLOCK DIAGRAM**



**MECHANICAL SPECIFICATIONS**

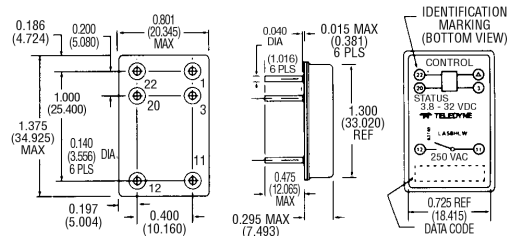

**KA SERIES**

**STATUS OUTPUT TRUTH TABLE**

Status	Control	Output
Output State	Input	(Load) State
Off (High)	Low	On
On (Low)	Low	Tripped (Off)
Off (High)	High	Off
On (Low)	High	Non-applicable condition

**STATUS OUTPUT SPECIFICATIONS**

	Min	Max	Units
Status Supply Voltage		32	Vdc
Status "OFF" Leakage Current @ 32 Vdc		10	μAdc
Status Sink Current (V <sub>so</sub> ≤ 0.4 Vdc)		10	mAdc
Status "ON" State Voltage @ 10mAdc		0.4	Vdc



**LA SERIES**

ENCLOSURE: Hermetically Sealed DIP  
LEAK RATE: 1 x 10<sup>-8</sup> CC/Sec Maximum  
MATERIAL: Header - Cold Rolled Steel  
                  Nickel Plated  
                  Pins - Copper Core  
                  Can - Cold Rolled Steel  
                  Nickel Plated

WEIGHT: 20 grams max  
TOLERANCE: .XX = ±.010 (±.25)  
                  .XXX = ±.005 (±.13)

DIMENSIONS ARE SHOWN IN INCHES  
(MILLIMETERS)

**ENVIRONMENTAL SPECIFICATIONS**

	Min	Max	Units
Ambient Temperature			
Operating	-55	+110	°C
Storage	-55	+125	°C
Shock (0.5 ms Pulse)		1500	g
Vibration (100 g)	10	3000	Hz
Acceleration		5000	g

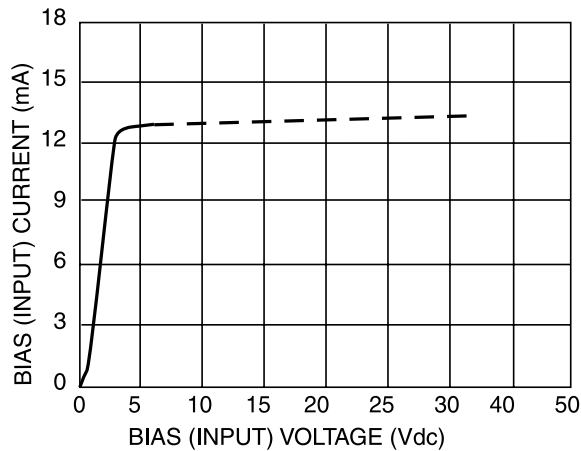

**INPUT CURRENT VS VOLTAGE**  
**FIGURE 2 (SEE NOTE 2)**

**NOTES:**

- Control input is compatible with CMOS or open collector TTL (with pull up resistor).
- For bias voltages above 6 Vdc, a series resistor is recommended. Use a standard resistor value equal to or less than the value found from Figure 6.
- Unless otherwise noted, the input voltage for functional tests shall be 5 Vdc.
- Output may temporarily lose blocking capability during and after a surge, until  $T_j$  falls below maximum.
- Transient suppression must be used to limit the voltage to < 500 Vpeak when switching inductive loads.

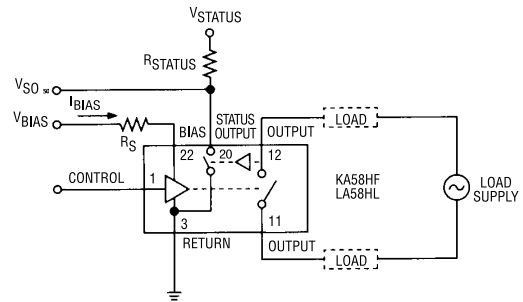

**(A) 3 TERMINAL INPUT WITH STATUS (See Note 7)**

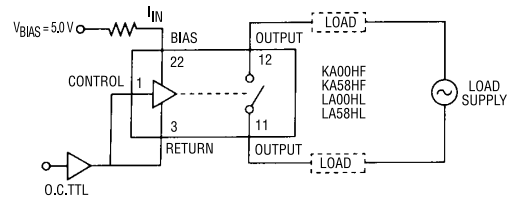

**(B) 2 TERMINAL INPUT (OPEN COLLECTOR TTL DRIVE)**

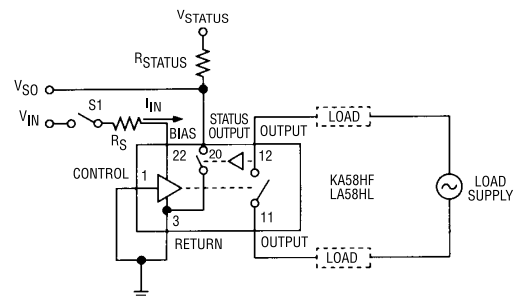

**(C) 2 TERMINAL INPUT (DIRECT DRIVE) WITH STATUS**

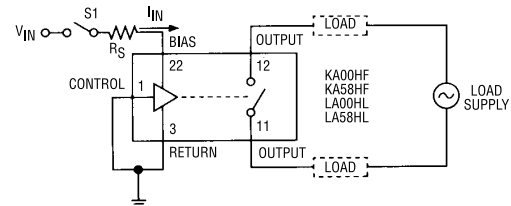

**(D) 2 TERMINAL INPUT (DIRECT DRIVE)**

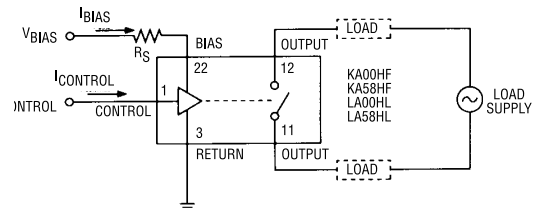

**(E) 3 TERMINAL INPUT WITHOUT STATUS**

**WIRING CONFIGURATION**  
**FIGURE 1**  
**(See Note 1 & 2)**



**THERMAL DERATING CURVE  
LA SERIES / KA SERIES WITHOUT HEATSINK  
FIGURE 3 (A)**



**TYPICAL VOLTAGE DROP VS LOAD CURRENT OF  
LA SERIES WITH 1 °C/W HEATSINK  
FIGURE 5**

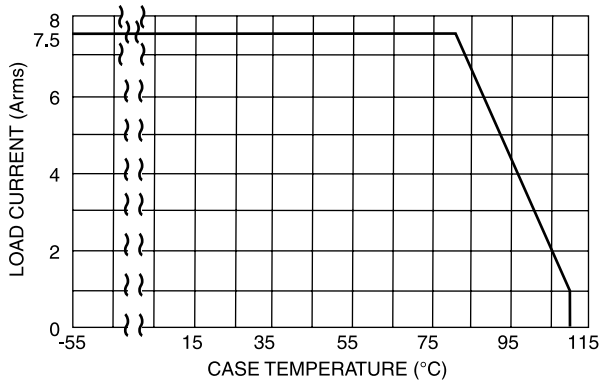

**THERMAL DERATING CURVE  
LA SERIES WITH HEATSINK  
FIGURE 3 (B)**

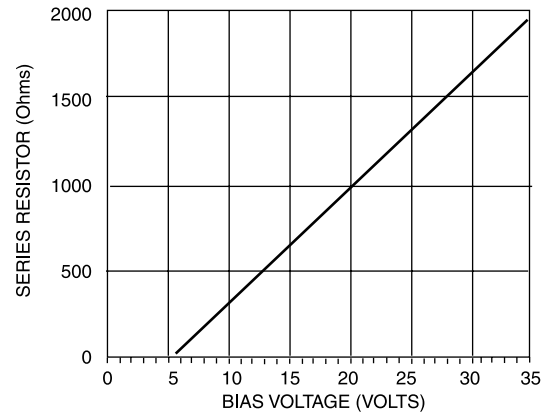

**SERIES LIMIT BIAS RESISTOR VS BIAS VOLTAGE  
FIGURE 6 (SEE NOTE 2)**



**TYPICAL VOLTAGE DROP VS LOAD CURRENT OF  
LA SERIES WITHOUT HEATSINK  
FIGURE 4**



**TYPICAL THERMAL TRIP TIME  
KA58HF AND LA58HL  
FIGURE 7**

Компания «Океан Электроники» предлагает заключение долгосрочных отношений при поставках импортных электронных компонентов на взаимовыгодных условиях!

Наши преимущества:

- Поставка оригинальных импортных электронных компонентов напрямую с производств Америки, Европы и Азии, а так же с крупнейших складов мира;
- Широкая линейка поставок активных и пассивных импортных электронных компонентов (более 30 млн. наименований);
- Поставка сложных, дефицитных, либо снятых с производства позиций;
- Оперативные сроки поставки под заказ (от 5 рабочих дней);
- Экспресс доставка в любую точку России;
- Помощь Конструкторского Отдела и консультации квалифицированных инженеров;
- Техническая поддержка проекта, помощь в подборе аналогов, поставка прототипов;
- Поставка электронных компонентов под контролем ВП;
- Система менеджмента качества сертифицирована по Международному стандарту ISO 9001;
- При необходимости вся продукция военного и аэрокосмического назначения проходит испытания и сертификацию в лаборатории (по согласованию с заказчиком);
- Поставка специализированных компонентов военного и аэрокосмического уровня качества (Xilinx, Altera, Analog Devices, Intersil, Interpoint, Microsemi, Actel, Aeroflex, Peregrine, VPT, Syfer, Eurofarad, Texas Instruments, MS Kennedy, Miteq, Cobham, E2V, MA-COM, Hittite, Mini-Circuits, General Dynamics и др.);

Компания «Океан Электроники» является официальным дистрибьютором и эксклюзивным представителем в России одного из крупнейших производителей разъемов военного и аэрокосмического назначения «JONHON», а так же официальным дистрибьютором и эксклюзивным представителем в России производителя высокотехнологичных и надежных решений для передачи СВЧ сигналов «FORSTAR».



## JONHON

«JONHON» (основан в 1970 г.)

Разъемы специального, военного и аэрокосмического назначения:

(Применяются в военной, авиационной, аэрокосмической, морской, железнодорожной, горно- и нефтедобывающей отраслях промышленности)

«FORSTAR» (основан в 1998 г.)

ВЧ соединители, коаксиальные кабели, кабельные сборки и микроволновые компоненты:

(Применяются в телекоммуникациях гражданского и специального назначения, в средствах связи, РЛС, а так же военной, авиационной и аэрокосмической отраслях промышленности).



Телефон: 8 (812) 309-75-97 (многоканальный)

Факс: 8 (812) 320-03-32

Электронная почта: [ocean@oceanchips.ru](mailto:ocean@oceanchips.ru)

Web: <http://oceanchips.ru/>

Адрес: 198099, г. Санкт-Петербург, ул. Калинина, д. 2, корп. 4, лит. А