

## RX62T Group, RX62G Group Renesas MCUs

R01DS0096EJ0200

Rev.2.00

Jan 10, 2014

100-MHz 32-bit RX MCUs, FPU, 165 DMIPS, 12-bit ADC (3 S/H circuits, double data register, amplifier, comparator): two units, 10-bit ADC one unit, the three ADC units are capable of simultaneous 7-ch. sampling, 100-MHz PWM (two three-phase complementary channels and four single-phase complementary channels or three three-phase complementary channels and one single-phase complementary channel)

## Features

### ■ 32-bit RX CPU core

- Max. operating frequency: 100 MHz  
Capable of 165 DMIPS in operation at 100 MHz
- Single precision 32-bit IEEE-754 floating point
- Accumulator handles 64-bit results (for a single instruction) from 32- × 32-bit operations
- Multiplication and division unit handles 32- × 32-bit operations (multiplication instructions take one CPU clock cycle)
- Fast interrupt
- Divider (fastest instruction execution takes two CPU clock cycles)
- Fast interrupt
- CISC Harvard architecture with 5-stage pipeline
- Variable-length instructions: Ultra-compact code
- Supports the memory protection unit (MPU)
- Background JTAG debugging plus high-speed tracing

### ■ Operating voltage

- Single 3.3- or 5-V supply; 5-V analog supply is possible with 3.3-V products

### ■ Low-power design and architecture

- Four low-power modes

### ■ On-chip main flash memory, no wait states

- 100-MHz operation, 10-ns read cycle
- No wait states for reading at full CPU speed
- 64-Kbyte/128-Kbyte/256-Kbyte capacities
- For instructions and operands
- User code programmable via the SCI or JTAG

### ■ On-chip data flash memory

- Max. 32 Kbytes, reprogrammable up to 30,000 times
- Erasing and programming impose no load on the CPU.

### ■ On-chip SRAM, no wait states

- 8-Kbyte/16-Kbyte SRAM
- For instructions and operands

### ■ DMA

- DTC: The single unit is capable of transfer on multiple channels

### ■ Reset and supply management

- Power-on reset (POR)
- Low voltage detection (LVD) with voltage settings

### ■ Clock functions

- External crystal oscillator or internal PLL for operation at 8 to 12.5 MHz
- Internal 125-kHz LOCO for the IWDT
- Detection of main oscillator stoppage (for IEC 60730 compliance)

### ■ Independent watchdog timer (for IEC60730compliance)

- 125-kHz LOCO clock operation
- Software is incapable of stopping the robust WDT.

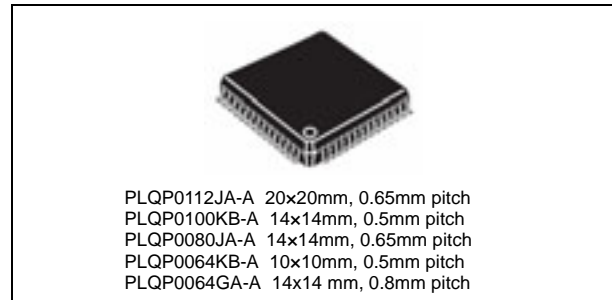

### ■ Up to 7 communications interfaces

- 1: CAN (compliant with ISO11898-1), incorporating 32 mailboxes
- 3: SCIs, with asynchronous mode (incorporating noise cancellation), clock-synchronous mode, and smart-card interface mode
- 1: I2C bus interface, capable of SMBus operation
- 1: RSPI
- 1: LIN

### ■ Up to 16 16-bit timers

- 8: 16-bit MTU3: 100-MHz operation, input capture, output compare, two three-phase complementary PWM output channels, complementary PWM imposing no load on the CPU, phase-counting mode
- 4: 16-bit GPT: 100-MHz operation, input capture, output compare, four complementary single-phase PWM output channels, or one three-phase complementary PWM output channel and one single-phase complementary PWM output channel, complementary PWM imposing no load on the CPU, operation linked with comparator (for counting and control of PWM-signal negation), detection of abnormal oscillation frequencies (for IEC 60730 compliance)
- 4: 16-bit CMT

### ■ Generation of delays in PWM waveforms (only for the RX62G Group)

- The timing with which signals on the 16-bit GPT PWM output pin rise and fall can be controlled with an accuracy of up to 312 ps (in operation at 100 MHz).

### ■ Three A/D converter units for 1-MHz operation, for a total of 20 channels

- Three units are capable of simultaneous sampling on seven channels
- Self diagnosis (for IEC60730 compliance)
- 8: Two 12-bit ADC units: three sample-and-hold circuits, double data registers, amplifier, comparator
- 12: Single 10-bit ADC unit

### ■ CRC (cyclic redundancy check) calculation unit

- Monitoring of data being transferred (for IEC 60730 compliance)
- Monitoring of data in memory (for IEC 60730 compliance)

### ■ Up to 61 input-output ports and up to 21 input-only ports

- PORT registers: Monitoring of output ports (for IEC 60730 compliance)

### ■ Operating temp. range

- -40°C to +85°C
- -40°C to +105°C

# 1. Overview

## 1.1 Outline of Specifications

Table 1.1 lists the specifications in outline, and Table 1.2 lists the functions of products.

**Table 1.1 Outline of Specifications (1 / 5)**

Classification	Module/Function	Description
CPU	CPU	<ul style="list-style-type: none"> <li>• Maximum operating frequency: 100MHz</li> <li>• 32-bit RX CPU</li> <li>• Minimum instruction execution time: One instruction per state (cycle of the system clock)</li> <li>• Address space: 4-Gbyte linear</li> <li>• Register set of the CPU</li> <li>• General purpose: Sixteen 32-bit registers</li> <li>• Control: Nine 32-bit registers</li> <li>• Accumulator: One 64-bit register</li> <li>• Basic instructions: 73</li> <li>• Floating-point instructions: 8</li> <li>• DSP instructions: 9</li> <li>• Addressing modes: 10</li> <li>• Data arrangement</li> <li>• Instructions: Little endian</li> <li>• Data: Selectable as little endian or big endian</li> <li>• On-chip 32-bit multiplier: 32 x 32 → 64 bits</li> <li>• On-chip divider: 32 / 32 → 32 bits</li> <li>• Barrel shifter: 32 bits</li> <li>• Memory-protection unit (MPU)</li> </ul>
	FPU	<ul style="list-style-type: none"> <li>• Single precision (32-bit) floating point</li> <li>• Data types and floating-point exceptions in conformance with the IEEE754 standard</li> </ul>
Memory	ROM	<ul style="list-style-type: none"> <li>• ROM capacity: 256 Kbytes (max.)</li> <li>• Two on-board programming modes</li> <li>• Boot mode (The user MAT is programmable via the SCI)</li> <li>• User program mode</li> <li>• Off-board programming</li> <li>• A PROM programmer can be used to program the user mat.</li> </ul>
	RAM	<ul style="list-style-type: none"> <li>• RAM capacity: 16 Kbytes (max.)</li> </ul>
	Data flash	<ul style="list-style-type: none"> <li>• Data flash capacity: 32 Kbytes (max.)</li> <li>• Supports background operations (BGO)</li> </ul>
MCU operating mode		<ul style="list-style-type: none"> <li>• Single-chip mode</li> </ul>
Clock	Clock generation circuit	<ul style="list-style-type: none"> <li>• One circuit: Main clock oscillator</li> <li>• Internal oscillator: Low-speed on-chip oscillator dedicated to IWDT</li> <li>• Structure of a PLL frequency synthesizer and frequency divider for selectable operating frequency</li> <li>• Oscillation stoppage detection</li> <li>• Independent frequency-division and multiplication settings for the system clock (ICLK) and peripheral module clock (PCLK)</li> <li>• The CPU and system sections such as other bus masters, MTU3, and GPT run in synchronization with the system clock (ICLK): 8 to 100 MHz.</li> <li>• Peripheral modules run in synchronization with the peripheral module clock (PCLK): 8 to 50 MHz</li> </ul>
Reset		Pin reset, power-on reset (automatic power-on reset when the power is turned on), voltage-monitoring reset, watchdog timer reset, independent watchdog timer reset, and deep software standby reset
Voltage detection circuit (LVD)		When the voltage on VCC falls below the voltage detection level (Vdet), an internal reset or internal interrupt is generated.
Low power consumption	Low power consumption facilities	<ul style="list-style-type: none"> <li>• Module stop function</li> <li>• Four low power consumption modes</li> <li>• Sleep mode, all-module clock stop mode, software standby mode, and deep software standby mode</li> </ul>

**Table 1.1 Outline of Specifications (2 / 5)**

Classification	Module/Function	Description
Interrupt	Interrupt controller (ICU)	<ul style="list-style-type: none"> <li>Peripheral function interrupts: 101 sources</li> <li>External interrupts: 9 (NMI and IRQ0 to IRQ7 pins)</li> <li>Non-maskable interrupts: 3 (the NMI pin, oscillation stop detection interrupt, and voltage-monitoring interrupt)</li> <li>16 levels specifiable for the order of priority</li> </ul>
Data transfer	Data transfer controller (DTC)	<ul style="list-style-type: none"> <li>Three transfer modes: Normal transfer, repeat transfer, and block transfer</li> <li>Activation sources: Software trigger, external interrupts, and interrupt requests from peripheral functions</li> </ul>
I/O ports	Programmable I/O ports	<p>I/O port pins for devices in the 112-pin LQFP/100-pin LQFP/80-pin LQFP (R5F562TxGDFF)/80-pin LQFP (except R5F562TxGDFF)/64-pin LQFP</p> <ul style="list-style-type: none"> <li>I/O: 61/55/44/44/37</li> <li>Input only: 21/21/13/13/9</li> <li>Open-drain outputs: 2/2/2/2/2 (I<sup>2</sup>C bus interface pins)</li> <li>Large-current outputs: 12/12/12/6/6(0) (MTU3 and GPT pins) The 5-V version of the 64-pin product does not have large-current outputs.</li> <li>Reading out the states of pins is always possible.</li> </ul>
Timers	Multi-function timer pulse unit 3 (MTU3)	<ul style="list-style-type: none"> <li>16 bits x 8 channels</li> <li>Up to 24 pulse inputs/outputs and three pulse inputs</li> <li>Select from among six to eight counter-input clock signals for each channel (ICLK/1, ICLK/4, ICLK/16, ICLK/64, ICLK/256, ICLK/1024, MTCLKA, MTCLKB, MTCLKC, MTCLKD) other than channel 5, for which only four signals are available.</li> <li>24 output compare or input capture registers</li> <li>Counter clearing (clearing is synchronizable with compare match or input capture)</li> <li>Simultaneous writing to multiple timer counters (TCNT)</li> <li>Input to and output from all registers in synchronization with counter operation</li> <li>Buffered operation</li> <li>Cascade-connected operation</li> <li>38 kinds of interrupt source</li> <li>Automatic transfer of register data</li> <li>Pulse output modes Toggled, PWM, complementary PWM, and reset synchronous PWM</li> <li>Complementary PWM output mode Outputs non-overlapping waveforms for controlling 3-phase inverters Automatic specification of dead times PWM duty cycle: Selectable as any value from 0% to 100% Delay can be applied to requests for A/D conversion. Non-generation of interrupt requests at peak or trough values of counters can be selected. Double buffering</li> <li>Reset-synchronous PWM mode Three PWM waveforms and corresponding inverse waveforms are output with the desired duty cycles.</li> <li>Phase-counting mode</li> <li>Counter functionality for dead-time compensation</li> <li>Generation of triggers for A/D converters</li> <li>Differential timing for initiation of A/D conversion</li> </ul>
	Port output enable 3 (POE3)	<ul style="list-style-type: none"> <li>Control of the high-impedance state of the MTU3 and GPT's waveform output pins</li> <li>5 pins for input from signal sources: POE0, POE4, POE8, POE10, POE11</li> <li>Initiation on detection of short-circuited outputs (detection of simultaneous switching of large-current pins to the active level)</li> <li>Initiation by comparator-detection of analog level input to the 12-bit A/D converter</li> <li>Initiation by oscillation-stoppage detection</li> <li>Initiation by software</li> <li>Selection of which output pins should be placed in the high-impedance state at the time of each POE input or comparator detection</li> </ul>

**Table 1.1 Outline of Specifications (3 / 5)**

Classification	Module/Function	Description
Timers	General PWM timer (GPT/GPTa)	<ul style="list-style-type: none"> <li>• 16 bits x 4 channels</li> <li>• Counting up or down (saw-wave), counting up and down (triangle-wave) selectable for all channels</li> <li>• Clock sources independently selectable for all channels</li> <li>• 2 input/output pins per channel</li> <li>• 2 output compare/input capture registers per channel</li> <li>• For the 2 output compare/input capture registers of each channel, 4 registers are provided as buffer registers and are capable of operating as comparison registers when buffering is not in use.</li> <li>• In output compare operation, buffer switching can be at peaks or troughs, enabling the generation of laterally asymmetrically PWM waveforms.</li> <li>• Registers for setting up frame intervals on each channel (with capability for generating interrupts on overflow or underflow)</li> <li>• Synchronizable operation of the several counters</li> <li>• Modes of synchronized operation (synchronized, or displaced by desired times for phase shifting)</li> <li>• Generation of dead times in PWM operation</li> <li>• Through combination of three counters, generation of automatic three-phase PWM waveforms incorporating dead times</li> <li>• Starting, clearing, and stopping counters in response to external or internal triggers</li> <li>• Internal trigger sources: output of the internal comparator detection, software, and compare-match</li> <li>• The frequency-divided system clock (ICLK) can be used as a counter clock for measuring timing of the edges of signals produced by frequency-dividing the low-speed on-chip oscillator clock signal dedicated to IWDT (to detect abnormal oscillation).</li> <li>• PWM delay generation can control the timing with which signals on the two PWM output pins for each channel rise and fall with an accuracy of up to 1/32 times the period of the system clock (ICLK) (only for GPTa).</li> </ul>
	Compare match timer (CMT)	<ul style="list-style-type: none"> <li>• (16 bits x 2 channels) x 2 units</li> <li>• Select from among four internal clock signals (PCLK/8, PCLK/32, PCLK/128, PCLK/512)</li> </ul>
	Watchdog timer (WDT)	<ul style="list-style-type: none"> <li>• 8 bits x 1 channel</li> <li>• Select from among eight counter-input clock signals (PCLK/4, PCLK/64, PCLK/128, PCLK/512, PCLK/2048, PCLK/8192, PCLK/32768, PCLK/131072)</li> <li>• Switchable between watchdog timer mode and interval timer mode</li> </ul>
	Independent watchdog timer (IWDT)	<ul style="list-style-type: none"> <li>• 14 bits x 1 channel</li> <li>• Counter-input clock: low-speed on-chip oscillator dedicated to IWDT</li> </ul>
Communications	Serial communications interface (SC1b)	<ul style="list-style-type: none"> <li>• 3 channels</li> <li>• Serial communications modes: Asynchronous, clock synchronous, and smart-card interface</li> <li>• Multiprocessor communications</li> <li>• On-chip baud rate generator allows selection of the desired bit rate</li> <li>• Choice of LSB-first or MSB-first transfer</li> <li>• Noise cancellation (only available in asynchronous mode)</li> </ul>
	I <sup>2</sup> C bus interface (RIIC)	<ul style="list-style-type: none"> <li>• 1 channel</li> <li>• Communications formats: I<sup>2</sup>C bus format/SMBus format</li> <li>• Master/slave selectable</li> </ul>

**Table 1.1 Outline of Specifications (4 / 5)**

Classification	Module/Function	Description
Communications	CAN module (CAN) (as an optional function)	<ul style="list-style-type: none"> <li>• 1 channel</li> <li>• 32 mailboxes</li> </ul>
	Serial peripheral interface (RSPI)	<ul style="list-style-type: none"> <li>• 1 unit</li> <li>• RSPI transfer facility Using the MOSI (master out, slave in), MISO (master in, slave out), SSL (slave select), and RSPI clock (RSPCK) signals enables serial transfer through SPI operation (four lines) or clock-synchronous operation (three lines) Capable of handling serial transfer as a master or slave</li> <li>• Data formats Switching between MSB first and LSB first The number of bits in each transfer can be changed to any number of bits from 8 to 16, or to 20, 24, or 32 bits. 128-bit buffers for transmission and reception Up to four frames can be transmitted or received in a single transfer operation (with each frame having up to 32 bits)</li> <li>• Buffered structure</li> <li>• Double buffers for both transmission and reception</li> </ul>
	LIN module (LIN)	<ul style="list-style-type: none"> <li>• 1 channel (LIN master)</li> <li>• Supports revisions 1.3, 2.0, and 2.1 of the LIN protocol</li> </ul>
A/D converter	12-bit A/D converter (S12ADA)	<ul style="list-style-type: none"> <li>• 12 bits (2 units x 4 channels)</li> <li>• 12-bit resolution</li> <li>• Conversion time: 1.0 <math>\mu</math>s per channel (in operation with A/D conversion clock ADCLK at 50 MHz) for AVCC = 4.0 to 5.5 V 2.0 <math>\mu</math>s per channel (in operation with A/D conversion clock ADCLK at 25 MHz) for AVCC0 = 3.0 to 3.6 V</li> <li>• Two basic operating modes Single mode and scan mode</li> <li>• Scan mode One-cycle scan mode Continuous scan mode 2-channel scan mode (Input ports of the A/D unit are divided into two groups in this mode, and the activation sources are separately selectable for each group.)</li> <li>• Sample-and-hold function A common sample-and-hold circuit for both units is included. Additionally, sample-and-hold circuit for each unit is included. (three channels per unit)</li> <li>• A/D-conversion register settings for each input pin.</li> <li>• Two registers for the result of conversion are provided for a single analog input pin of each unit (AN000 and AN100).</li> <li>• Three ways to start A/D conversion Conversion can be started by software, a conversion start trigger from a timer (MTU3 or GPT), or an external trigger signal.</li> <li>• Functionality for 8- or 10-bit precision output Right-shifting of the results of conversion for output by two or four bits is selectable.</li> <li>• Self-diagnostic function The self-diagnostic function internally generates three analog input voltages (VREFL0, VREFH0 x 1/2, VREFH0).</li> <li>• Amplification of input signals by a programmable gain amplifier (three channels per unit) Amplification rate: 2.0-, 2.5-, 3.077-, 3.636-, 4.0-, 4.444-, 5.0-, 5.714-, 6.667-, 10.0-, or 13.333-times amplification (a total of 11 steps)</li> <li>• Window comparators (three channels per unit)</li> </ul>

**Table 1.1 Outline of Specifications (5 / 5)**

Classification	Module/Function	Description
A/D converter	10-bit A/D converter (ADA)	<ul style="list-style-type: none"> <li>• 10 bits (1 unit x 12 channels)</li> <li>• 10-bit resolution</li> <li>• Conversion time:               <ul style="list-style-type: none"> <li>1.0 <math>\mu</math>s per channel (in operation with A/D conversion clock ADCLK at 50 MHz) for AVCC0 = 4.0 to 5.5 V</li> <li>2.0 <math>\mu</math>s per channel (in operation with A/D conversion clock ADCLK at 25 MHz) for AVCC = 3.0 to 3.6 V</li> </ul> </li> <li>• Two basic operating modes               <ul style="list-style-type: none"> <li>Single mode and scan mode</li> </ul> </li> <li>• Scan mode               <ul style="list-style-type: none"> <li>One-cycle scan mode</li> <li>Continuous scan mode</li> </ul> </li> <li>• Sample-and-hold function               <ul style="list-style-type: none"> <li>A common sample-and-hold circuit for both units is included.</li> </ul> </li> <li>• A/D-conversion register settings for each input pin</li> <li>• Three ways to start A/D conversion               <ul style="list-style-type: none"> <li>Conversion can be started by software, a conversion start trigger from a timer (MTU3 or GPT), or an external trigger signal.</li> </ul> </li> <li>• Functionality for 8-bit precision output               <ul style="list-style-type: none"> <li>Right-shifting the results of conversion for output by two bits is selectable.</li> </ul> </li> <li>• Self-diagnostic function               <ul style="list-style-type: none"> <li>The self-diagnostic function internally generates three analog input voltages (AVSS, VREF x 1/2, VREF).</li> </ul> </li> </ul>
CRC calculator (CRC)		<ul style="list-style-type: none"> <li>• CRC code generation for arbitrary amounts of data in 8-bit units</li> <li>• Select any of three generating polynomials:  <math>X^8 + X^2 + X + 1</math>, <math>X^{16} + X^{15} + X^2 + 1</math>, or <math>X^{16} + X^{12} + X^5 + 1</math>.</li> <li>• Generation of CRC codes for use with LSB-first or MSB-first communications is selectable.</li> </ul>
Operating frequency		ICLK: 8 to 100 MHz PCLK: 8 to 50 MHz
Power supply voltage		<ul style="list-style-type: none"> <li>• 3-V version               <ul style="list-style-type: none"> <li>VCC = PLLVCC = 2.7 to 3.6V</li> <li>AVCC0 = AVCC = 3.0 to 3.6V, or 4.0 to 5.5V</li> <li>VREFH0 = 3.0 to AVCC0, or 4.0 to AVCC0</li> <li>VREF = 3.0 to AVCC, or 4.0 to AVCC</li> </ul> </li> <li>• 5-V version               <ul style="list-style-type: none"> <li>VCC = PLLVCC = 4.0 to 5.5V</li> <li>AVCC0 = AVCC = 4.0 to 5.5V</li> <li>VREFH0 = 4.0 to AVCC0</li> <li>VREF = 4.0 to AVCC</li> </ul> </li> </ul>
Operating temperature		D version: -40 to +85°C, G version: -40 to +105°C*1
Packages		112-pin LQFP (PLQP0112JA-A, 20x20-0.65-mm pitch) 100-pin LQFP (PLQP0100KB-A, 14x14-0.5-mm pitch) 80-pin LQFP (PLQP0080JA-A, 14x14-0.65-mm pitch) 64-pin LQFP (PLQP0064KB-A, 10x10-0.5-mm pitch) 64-pin LQFP (PLQP0064GA-A, 14x14-0.8mm pitch)

Note 1. Please contact Renesas Electronics sales office for derating of operation under  $T_a = +85^\circ\text{C}$  to  $+105^\circ\text{C}$ . Derating is the systematic reduction of load for the sake of improved reliability.

**Table 1.2 Functions of RX62T Group and RX62G Group Products (1 / 2)**

Functions		RX62G Group		RX62T Group				
		112 Pins	100 Pins	112 Pins	100 Pins	80 Pins (R5F562T xGDFF)	80 Pins	64 Pins
Data transfer	Data transfer controller (DTC)	√						
Interrupt controller (ICU)	Input on the NMI pin	√						
	Input on the IRQ pins	√ (8)						√ (4)
Timers	Multi-function timer pulse unit 3 (MTU3)	√				√*1		
	General PWM timer (GPT)	—		√		√*1		
	General PWM timer (GPTa)	√		—				
	MTU3/GPT complementary PWM pin	12					6	
	Port output enable 3 (POE3)	√ (POE pins: 5)						√ (POE pins: 3)
	Compare match timer (CMT)	√						
	Watchdog timer (WDT)	√						
	Independent watchdog timer (IWDT)	√						
Communication function	Serial communications interface (SCI)	√						
	I <sup>2</sup> C bus interface (RIIC)	√						
	CAN module (CAN) (as an optional function)	√						
	LIN module (LIN)	√						
	Serial peripheral interface (RSPI)	√						
12-bit A/D converter (S12ADA)		√ (4 ch. x 2 units)						
	Simultaneous sampling on three channels	√ (2 units)						
	Programmable gain amplifier	√ (3 ch. x 2 units)						
	Window comparator	√ (3 ch. x 2 units)						
10-bit A/D converter (ADA)	√ (12 ch.)				√ (4 ch.)		—	
CRC calculator (CRC)	√							
I/O ports	I/O pins	61	55	61	55	44	44	37
	Input pins	21	21	21	21	13	13	9

**Table 1.2 Functions of RX62T Group and RX62G Group Products (2 / 2)**

Functions	RX62G Group		RX62T Group				
	112 Pins	100 Pins	112 Pins	100 Pins	80 Pins (R5F562T xGDFF)	80 Pins	64 Pins
Package	LQFP2020 (0.65-mm pitch)	LQFP1414 (0.5-mm pitch)	LQFP2020 (0.65-mm pitch)	LQFP1414 (0.5-mm pitch)	LQFP1414 (0.65-mm pitch)	LQFP1414 (0.65-mm pitch)	LQFP1010 (0.5-mm pitch) LQFP1414 (0.8-mm pitch)

O: Supported, —: Not supported

Note 1. For the MTU and GPT, the number of pins will differ with the package. See the list of pins and pin functions for details.  
In addition, the CAN module is an optional function. See Table 1.3 for details.



## 1.2 List of Products

Table 1.3 is a list of products, and Figure 1.1 shows how to read the product part no.

**Table 1.3 List of Products (1 / 2)**

Group	Part No.	Order Part No.	Package	ROM Capacity	RAM Capacity	Data Flash Capacity	Power Supply Voltage	CAN	Operating Temp. Range			
RX62T	R5F562TAADFH	R5F562TAADFH#V3	PLQP0112JA-A	256 Kbytes	16 Kbytes	32 Kbytes	VCC/PLLVC 4.0 to 5.5 V AVCC/AVCC0 4.0 to 5.5 V	Support- ed	-40 to +85°C (D version)			
	R5F562TAADFP	R5F562TAADFP#V3	PLQP0100KB-A									
	R5F562TAADFF	R5F562TAADFF#V3	PLQP0080JA-A									
	R5F562TAGDFF	R5F562TAGDFF#V3	PLQP0080JA-A									
	R5F562TAADFM	R5F562TAADFM#V3	PLQP0064KB-A									
	R5F562TAADFK	R5F562TAADFK#V3	PLQP0064GA-A									
	R5F562T7ADFH	R5F562T7ADFH#V3	PLQP0112JA-A	128 Kbytes	8 Kbytes	8 Kbytes						
	R5F562T7ADFP	R5F562T7ADFP#V3	PLQP0100KB-A									
	R5F562T7ADFF	R5F562T7ADFF#V3	PLQP0080JA-A									
	R5F562T7GDFF	R5F562T7GDFF#V3	PLQP0080JA-A									
	R5F562T7ADFM	R5F562T7ADFM#V3	PLQP0064KB-A									
	R5F562T7ADFK	R5F562T7ADFK#V3	PLQP0064GA-A									
	R5F562T6ADFF	R5F562T6ADFF#V3	PLQP0080JA-A	64 Kbytes	8 Kbytes							
	R5F562T6ADFM	R5F562T6ADFM#V3	PLQP0064KB-A									
	R5F562T6ADFK	R5F562T6ADFK#V3	PLQP0064GA-A									
	R5F562TABDFH	R5F562TABDFH#V3	PLQP0112JA-A	256 Kbytes	16 Kbytes	32 Kbytes	VCC/PLLVC 2.7 to 3.6 V AVCC/AVCC0 3.0 to 3.6 V or 4.0 to 5.5 V					
	R5F562TABDFP	R5F562TABDFP#V3	PLQP0100KB-A									
	R5F562TABDFF	R5F562TABDFF#V3	PLQP0080JA-A									
	R5F562TABDFM	R5F562TABDFM#V3	PLQP0064KB-A									
	R5F562TABDFK	R5F562TABDFK#V3	PLQP0064GA-A									
	R5F562T7BDFH	R5F562T7BDFH#V3	PLQP0112JA-A	128 Kbytes	8 Kbytes	8 Kbytes						
	R5F562T7BDFF	R5F562T7BDFF#V3	PLQP0080JA-A									
	R5F562T7BDFM	R5F562T7BDFM#V3	PLQP0064KB-A									
	R5F562T7BDFK	R5F562T7BDFK#V3	PLQP0064GA-A									
	R5F562T6BDFF	R5F562T6BDFF#V3	PLQP0080JA-A							64 Kbytes	8 Kbytes	
	R5F562T6BDFM	R5F562T6BDFM#V3	PLQP0064KB-A									
	R5F562T6BDFK	R5F562T6BDFK#V3	PLQP0064GA-A									
	R5F562TADDFH	R5F562TADDFH#V3	PLQP0112JA-A	256 Kbytes	16 Kbytes	32 Kbytes	4.0 to 5.5 V	Not Support- ed				
	R5F562TADDFP	R5F562TADDFP#V3	PLQP0100KB-A									
	R5F562TADDFM	R5F562TADDFM#V3	PLQP0064KB-A									
	R5F562TADDFK	R5F562TADDFK#V3	PLQP0064GA-A									
	R5F562T7DDFH	R5F562T7DDFH#V3	PLQP0112JA-A							128 Kbytes	8 Kbytes	8 Kbytes
	R5F562T7DDFP	R5F562T7DDFP#V3	PLQP0100KB-A									
	R5F562T7DDFF	R5F562T7DDFF#V3	PLQP0080JA-A									
	R5F562T7DDFM	R5F562T7DDFM#V3	PLQP0064KB-A									
	R5F562T7DDFK	R5F562T7DDFK#V3	PLQP0064GA-A									
	R5F562T6DDFF	R5F562T6DDFF#V3	PLQP0080JA-A	64 Kbytes	8 Kbytes							
	R5F562T6DDFM	R5F562T6DDFM#V3	PLQP0064KB-A									
	R5F562T6DDFK	R5F562T6DDFK#V3	PLQP0064GA-A									
	R5F562TAEDFH	R5F562TAEDFH#V3	PLQP0112JA-A	256 Kbytes	16 Kbytes	32 Kbytes	2.7 to 3.6 V					
R5F562TAEDFP	R5F562TAEDFP#V3	PLQP0100KB-A										
R5F562TAEDFF	R5F562TAEDFF#V3	PLQP0080JA-A										
R5F562TAEDFM	R5F562TAEDFM#V3	PLQP0064KB-A										
R5F562TAEDFK	R5F562TAEDFK#V3	PLQP0064GA-A										

**Table 1.3 List of Products ( 2 / 2 )**

Group	Part No.	Order Part No.	Package	ROM Capacity	RAM Capacity	Data Flash Capacity	Power Supply Voltage	CAN	Operating Temp. Range
RX62T	R5F562T7EDFH	R5F562T7EDFH#V3	PLQP0112JA-A	128 Kbytes	8 Kbytes	8 Kbytes	2.7 to 3.6 V	Not Supported	-40 to +85°C (D version)
	R5F562T7EDFP	R5F562T7EDFP#V3	PLQP0100KB-A						
	R5F562T7EDFF	R5F562T7EDFF#V3	PLQP0080JA-A						
	R5F562T7EDFM	R5F562T7EDFM#V3	PLQP0064KB-A						
	R5F562T7EDFK	R5F562T7EDFK#V3	PLQP0064GA-A						
	R5F562T6EDFF	R5F562T6EDFF#V3	PLQP0080JA-A	64 Kbytes	8 Kbytes				
	R5F562T6EDFM	R5F562T6EDFM#V3	PLQP0064KB-A						
	R5F562T6EDFK	R5F562T6EDFK#V3	PLQP0064GA-A						
	R5F562TAAGFH	R5F562TAAGFH#V3	PLQP0112JA-A	256 Kbytes	16 Kbytes	32 Kbytes	VCC/PLLVCC 4.0 to 5.5 V AVCC/AVCC0 4.0 to 5.5 V	Supported	-40 to +105°C (G version) *1
	R5F562TAAGFP	R5F562TAAGFP#V3	PLQP0100KB-A						
	R5F562TAAGFF	R5F562TAAGFF#V3	PLQP0080JA-A						
	R5F562TAGGFF	R5F562TAGGFF#V3	PLQP0080JA-A						
	R5F562TAAGFM	R5F562TAAGFM#V3	PLQP0064KB-A						
	R5F562TAAGFK	R5F562TAAGFK#V3	PLQP0064GA-A						
	R5F562T7AGFH	R5F562T7AGFH#V3	PLQP0112JA-A	128 Kbytes	8 Kbytes	8 Kbytes			
	R5F562T7AGFP	R5F562T7AGFP#V3	PLQP0100KB-A						
	R5F562T7AGFF	R5F562T7AGFF#V3	PLQP0080JA-A						
	R5F562T7GGFF	R5F562T7GGFF#V3	PLQP0080JA-A						
	R5F562T7AGFM	R5F562T7AGFM#V3	PLQP0064KB-A						
	R5F562T7AGFK	R5F562T7AGFK#V3	PLQP0064GA-A						
	R5F562T6AGFF	R5F562T6AGFF#V3	PLQP0080JA-A	64 Kbytes	8 Kbytes				
	R5F562T6AGFM	R5F562T6AGFM#V3	PLQP0064KB-A						
	R5F562T6AGFK	R5F562T6AGFK#V3	PLQP0064GA-A						
	R5F562TABGFH	R5F562TABGFH#V3	PLQP0112JA-A	256 Kbytes	16 Kbytes	32 Kbytes	VCC/PLLVCC 2.7 to 3.6 V AVCC/AVCC0 3.0 to 3.6 V or 4.0 to 5.5 V		
	R5F562TABGFP	R5F562TABGFP#V3	PLQP0100KB-A						
	R5F562TABGFF	R5F562TABGFF#V3	PLQP0080JA-A						
	R5F562TABGFM	R5F562TABGFM#V3	PLQP0064KB-A						
	R5F562TABGFK	R5F562TABGFK#V3	PLQP0064GA-A						
	R5F562T7BGFH	R5F562T7BGFH#V3	PLQP0112JA-A	128 Kbytes	8 Kbytes	8 Kbytes			
	R5F562T7BGFP	R5F562T7BGFP#V3	PLQP0100KB-A						
	R5F562T7BGFF	R5F562T7BGFF#V3	PLQP0080JA-A						
	R5F562T7BGFM	R5F562T7BGFM#V3	PLQP0064KB-A						
R5F562T7BGFK	R5F562T7BGFK#V3	PLQP0064GA-A							
R5F562T6BGFF	R5F562T6BGFF#V3	PLQP0080JA-A	64 Kbytes	8 Kbytes					
R5F562T6BGFM	R5F562T6BGFM#V3	PLQP0064KB-A							
R5F562T6BGFK	R5F562T6BGFK#V3	PLQP0064GA-A							
RX62G	R5F562GAADFH	R5F562GAADFH#V3	PLQP0112JA-A	256 Kbytes	16 Kbytes	32 Kbytes	VCC/PLLVCC 4.0 to 5.5 V AVCC/AVCC0 4.0 to 5.5 V	Supported	-40 to +85°C (D version)
	R5F562GAADFP	R5F562GAADFP#V3	PLQP0100KB-A						
	R5F562G7ADFH	R5F562G7ADFH#V3	PLQP0112JA-A	128 Kbytes	8 Kbytes	8 Kbytes			
	R5F562G7ADFP	R5F562G7ADFP#V3	PLQP0100KB-A						
	R5F562GADDFH	R5F562GADDFH#V3	PLQP0112JA-A	256 Kbytes	16 Kbytes	32 Kbytes		Not Supported	
	R5F562GADDFP	R5F562GADDFP#V3	PLQP0100KB-A						
	R5F562G7DDFH	R5F562G7DDFH#V3	PLQP0112JA-A	128 Kbytes	8 Kbytes	8 Kbytes			
	R5F562G7DDFP	R5F562G7DDFP#V3	PLQP0100KB-A						
	R5F562GAAGFH	R5F562GAAGFH#V3	PLQP0112JA-A	256 Kbytes	16 Kbytes	32 Kbytes	VCC/PLLVCC 4.0 to 5.5 V AVCC/AVCC0 4.0 to 5.5 V	Supported	-40 to +105°C (G versio) *1
	R5F562GAAGFP	R5F562GAAGFP#V3	PLQP0100KB-A						
	R5F562G7AGFH	R5F562G7AGFH#V3	PLQP0112JA-A	128 Kbytes	8 Kbytes	8 Kbytes			
	R5F562G7AGFP	R5F562G7AGFP#V3	PLQP0100KB-A						

Note 1. Please contact us if you are using a G version.



Figure 1.1 How to Read the Product Part No.

### 1.3 Block Diagram

Figure 1.2 shows a block diagram.



Figure 1.2 Block Diagram

### 1.4 Pin Assignments

Figure 1.3 to Figure 1.7 show the pins assignments. Table 1.4 to Table 1.8 show the list of pins and pin functions.



Figure 1.3 Pin Assignment of the 112-Pin LQFP

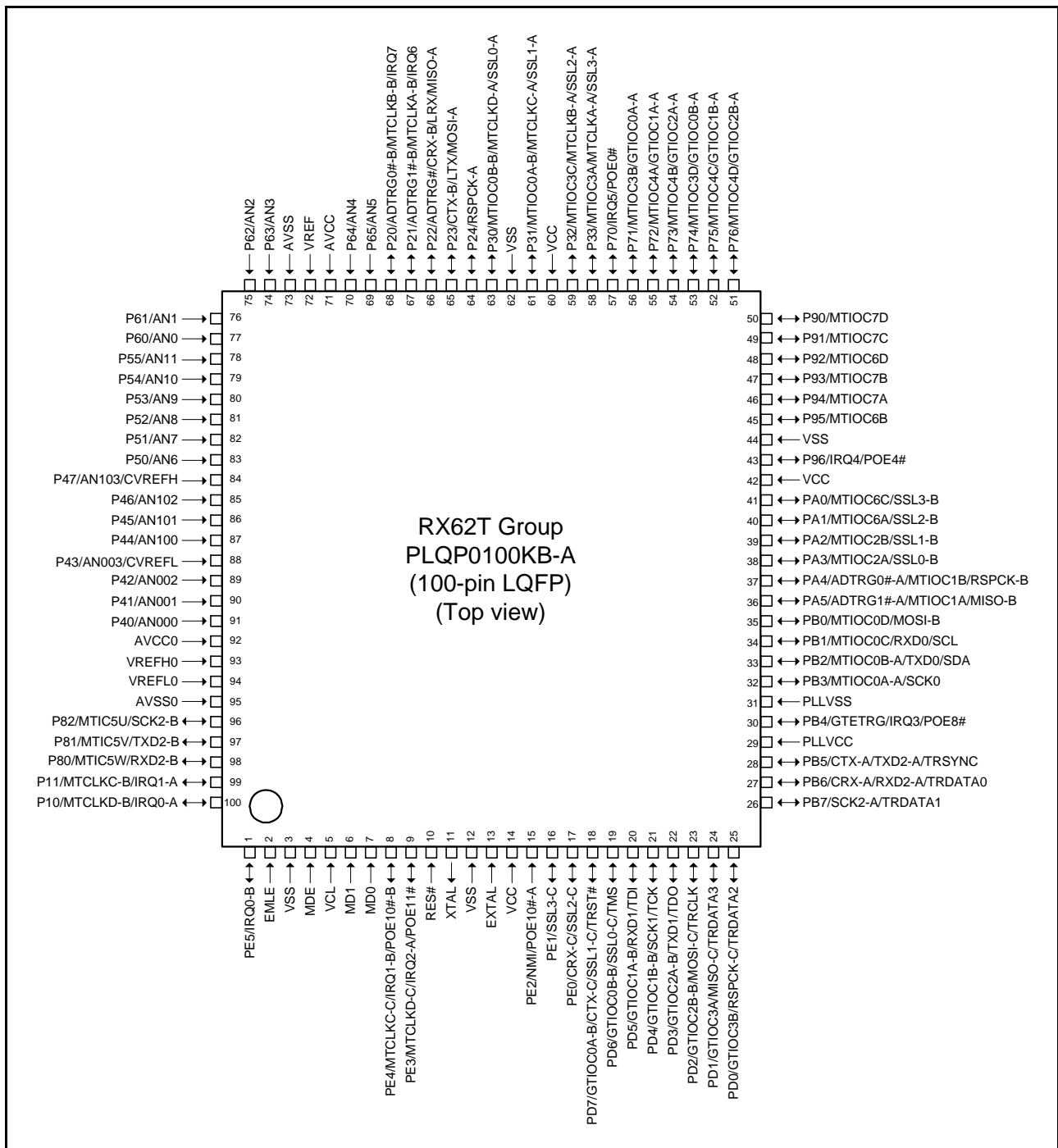

Figure 1.4 Pin Assignment of the 100-Pin LQFP

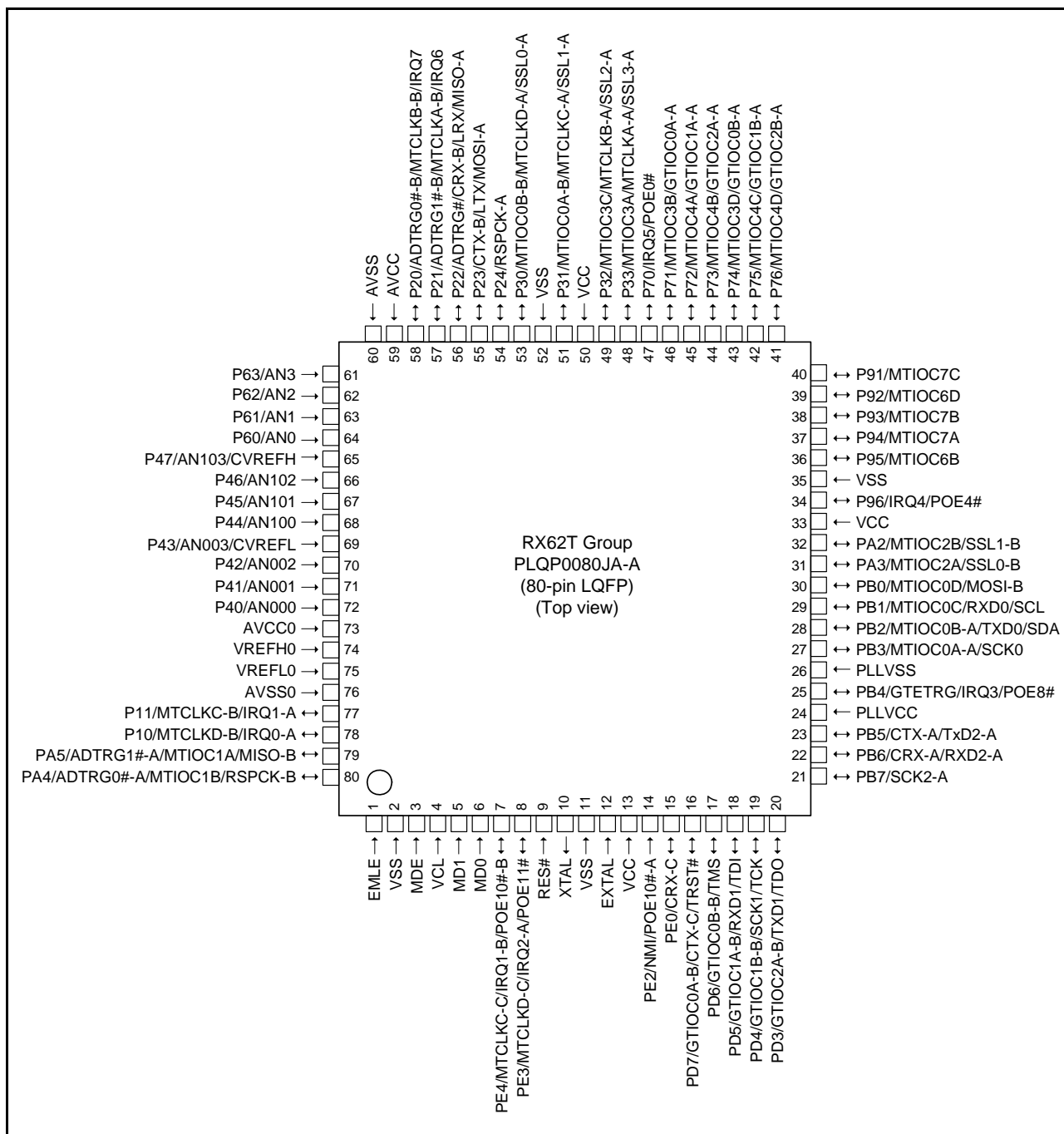

Figure 1.5 Pin Assignment of the 80-Pin LQFP

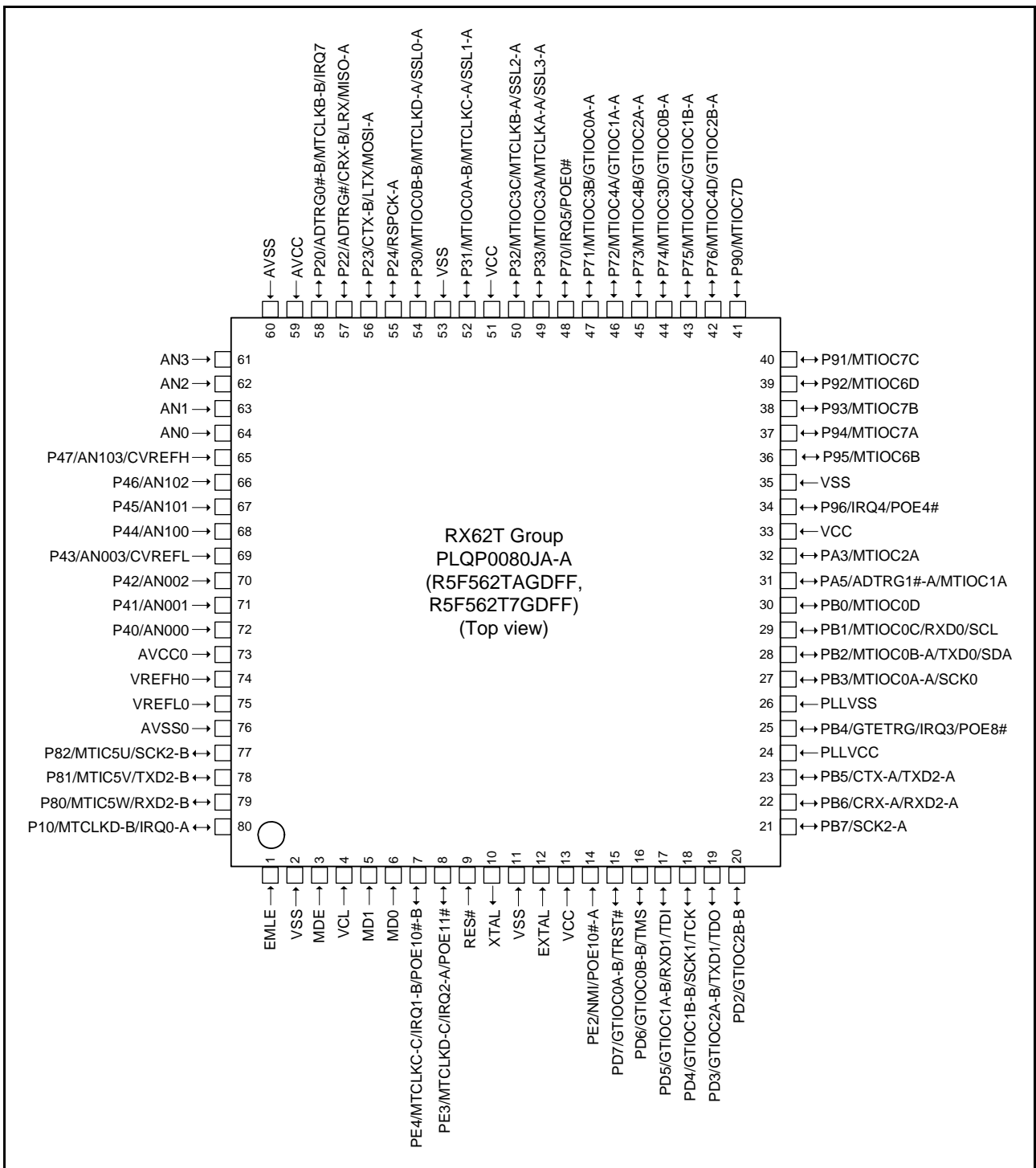

Figure 1.6 Pin Assignment of the 80-Pin LQFP (Two-Motor Control Supported Version)





Figure 1.7 Pin Assignment of the 64-Pin LQFP

**Table 1.4 List of Pins and Pin Functions (112-Pin LQFP) (1 / 3)**

Pin No. (112-Pin LQFP)	Power Supply Clock System Control	I/O Port	Analog	Timer	Communi- cation	Interrupt	POE	Debugging
1		PE5				IRQ0-B		
2	EMLE							
3	VSS							
4	MDE							
5	VCL							
6	MD1							
7	MD0							
8		PE4		MTCLKC-C		IRQ1-B	POE10#-B	
9		PE3		MTCLKD-C		IRQ2-A	POE11#	
10	RES#							
11	XTAL							
12	VSS							
13	EXTAL							
14	VCC							
15		PE2				NMI	POE10#-A	
16		PE1			SSL3-C			
17		PE0			CRX-C/ SSL2-C			
18		PD7		GTIOC0A-B	CTX-C/ SSL1-C			
19		PD6		GTIOC0B-B	SSL0-C			
20		PD5		GTIOC1A-B	RXD1			
21		PD4		GTIOC1B-B	SCK1			
22		PD3		GTIOC2A-B	TXD1			
23		PD2		GTIOC2B-B	MOSI-C			
24		PD1		GTIOC3A	MISO-C			
25		PD0		GTIOC3B	RSPCK-C			
26								TDI
27								TCK
28								TDO
29		PB7			SCK2-A			
30		PB6			CRX-A/ RXD2-A			
31		PB5			CTX-A/ TXD2-A			
32	PLLVCC							
33		PB4		GTETRG		IRQ3	POE8#	
34	PLLSS							
35		PB3		MTIOC0A-A	SCK0			
36		PB2		MTIOC0B-A	TXD0/SDA			
37		PB1		MTIOC0C	RXD0/SCL			
38		PB0		MTIOC0D	MOSI-B			
39		PA5	ADTRG1#-A	MTIOC1A	MISO-B			
40		PA4	ADTRG0#-A	MTIOC1B	RSPCK-B			
41		PA3		MTIOC2A	SSL0-B			
42		PA2		MTIOC2B	SSL1-B			
43		PA1		MTIOC6A	SSL2-B			

**Table 1.4 List of Pins and Pin Functions (112-Pin LQFP) (2 / 3)**

Pin No. (112-Pin LQFP)	Power Supply Clock System Control	I/O Port	Analog	Timer	Communi- cation	Interrupt	POE	Debugging
44		PA0		MTIOC6C	SSL3-B			
45	VCC							
46		P96				IRQ4	POE4#	
47	VSS							
48		P95		MTIOC6B				
49		P94		MTIOC7A				
50		P93		MTIOC7B				
51		P92		MTIOC6D				
52		P91		MTIOC7C				
53		P90		MTIOC7D				
54		PG5						TRCLK
55		PG4						TRDATA3
56		PG3						TRDATA2
57		PG2				IRQ2-B		TRDATA1
58		PG1				IRQ1-C		TRDATA0
59		PG0				IRQ0-C		TRSYNC
60		P76		MTIOC4D/ GTIOC2B-A				
61		P75		MTIOC4C/ GTIOC1B-A				
62		P74		MTIOC3D/ GTIOC0B-A				
63		P73		MTIOC4B/ GTIOC2A-A				
64		P72		MTIOC4A/ GTIOC1A-A				
65		P71		MTIOC3B/ GTIOC0A-A				
66		P70				IRQ5	POE0#	
67		P33		MTIOC3A/ MTCLKA-A	SSL3-A			
68		P32		MTIOC3C/ MTCLKB-A	SSL2-A			
69	VCC							
70		P31		MTIOC0A-B/ MTCLKC-A	SSL1-A			
71	VSS							
72		P30		MTIOC0B-B/ MTCLKD-A	SSL0-A			
73		P24			RSPCK-A			
74		P23			CTX-B/ LTX/ MOSI-A			
75		P22	ADTRG#		CRX-B/ LRX/ MISO-A			
76		P21	ADTRG1#-B	MTCLKA-B		IRQ6		
77		P20	ADTRG0#-B	MTCLKB-B		IRQ7		
78		P65	AN5					
79		P64	AN4					

**Table 1.4 List of Pins and Pin Functions (112-Pin LQFP) (3 / 3)**

Pin No. (112-Pin LQFP)	Power Supply Clock System Control	I/O Port	Analog	Timer	Communi- cation	Interrupt	POE	Debugging
80	AVCC							
81	VREF							
82	AVSS							
83		P63	AN3					
84		P62	AN2					
85		P61	AN1					
86		P60	AN0					
87		P55	AN11					
88		P54	AN10					
89		P53	AN9					
90		P52	AN8					
91		P51	AN7					
92		P50	AN6					
93		P47	AN103/ CVREFH					
94		P46	AN102					
95		P45	AN101					
96		P44	AN100					
97		P43	AN003/ CVREFL					
98		P42	AN002					
99		P41	AN001					
100		P40	AN000					
101	AVCC0							
102	VREFH0							
103	VREFL0							
104	AVSS0							
105		P82		MTIC5U	SCK2-B			
106		P81		MTIC5V	TXD2-B			
107		P80		MTIC5W	RXD2-B			
108				WDTOVF#				
109		P11		MTCLKC-B		IRQ1-A		
110		P10		MTCLKD-B		IRQ0-A		
111								TRST#
112								TMS

**Table 1.5 List of Pins and Pin Functions (100-Pin LQFP) (1 / 3)**

Pin No. (80-Pin LQFP)	Power Supply Clock System Control	I/O Port	Analog	Timer	Communi- cation	Interrupt	POE	Debugging
1		PE5				IRQ0-B		
2	EMLE							
3	VSS							
4	MDE							
5	VCL							
6	MD1							
7	MD0							
8		PE4		MTCLKC-C		IRQ1-B	POE10#-B	
9		PE3		MTCLKD-C		IRQ2-A	POE11#	
10	RES#							
11	XTAL							
12	VSS							
13	EXTAL							
14	VCC							
15		PE2				NMI	POE10#-A	
16		PE1			SSL3-C			
17		PE0			CRX-C/ SSL2- C			
18		PD7		GTIOC0A-B	CTX-C/SSL1-C			TRST#
19		PD6		GTIOC0B-B	SSL0-C			TMS
20		PD5		GTIOC1A-B	RXD1			TDI
21		PD4		GTIOC1B-B	SCK1			TCK
22		PD3		GTIOC2A-B	TXD1			TDO
23		PD2		GTIOC2B-B	MOSI-C			TRCLK
24		PD1		GTIOC3A	MISO-C			TRDATA3
25		PD0		GTIOC3B	RSPCK-C			TRDATA2
26		PB7			SCK2-A			TRDATA1
27		PB6			CRX-A/ RXD2- A			TRDATA0
28		PB5			CTX-A/TXD2-A			TRSYNC
29	PLLVCC							
30		PB4		GTETRG		IRQ3	POE8#	
31	PLLVSS							
32		PB3		MTIOC0A-A	SCK0			
33		PB2		MTIOC0B-A	TXD0/SDA			
34		PB1		MTIOC0C	RXD0/SCL			
35		PB0		MTIOC0D	MOSI-B			
36		PA5	ADTRG1#-A	MTIOC1A	MISO-B			
37		PA4	ADTRG0#-A	MTIOC1B	RSPCK-B			
38		PA3		MTIOC2A	SSL0-B			
39		PA2		MTIOC2B	SSL1-B			
40		PA1		MTIOC6A	SSL2-B			

**Table 1.5 List of Pins and Pin Functions (100-Pin LQFP) (2 / 3)**

Pin No. (80-Pin LQFP)	Power Supply Clock System Control	I/O Port	Analog	Timer	Communi- cation	Interrupt	POE	Debugging
41		PA0		MTIOC6C	SSL3-B			
42	VCC							
43		P96				IRQ4	POE4#	
44	VSS							
45		P95		MTIOC6B				
46		P94		MTIOC7A				
47		P93		MTIOC7B				
48		P92		MTIOC6D				
49		P91		MTIOC7C				
50		P90		MTIOC7D				
51		P76		MTIOC4D/ GTIOC2B-A				
52		P75		MTIOC4C/ GTIOC1B-A				
53		P74		MTIOC3D/ GTIOC0B-A				
54		P73		MTIOC4B/ GTIOC2A-A				
55		P72		MTIOC4A/ GTIOC1A-A				
56		P71		MTIOC3B/ GTIOC0A-A				
57		P70				IRQ5	POE0#	
58		P33		MTIOC3A/ MTCLKA-A	SSL3-A			
59		P32		MTIOC3C/ MTCLKB-A	SSL2-A			
60	VCC							
61		P31		MTIOC0A-B/ MTCLKC-A	SSL1-A			
62	VSS							
63		P30		MTIOC0B-B/ MTCLKD-A	SSL0-A			
64		P24			RSPCK-A			
65		P23			CTX-B/ LTX/ MOSI-A			
66		P22	ADTRG#		CRX-B/ LRX/ MISO-A			
67		P21	ADTRG1#-B	MTCLKA-B		IRQ6		
68		P20	ADTRG0#-B	MTCLKB-B		IRQ7		
69		P65	AN5					
70		P64	AN4					
71	AVCC							
72	VREF							
73	AVSS							
74		P63	AN3					
75		P62	AN2					
76		P61	AN1					

**Table 1.5 List of Pins and Pin Functions (100-Pin LQFP) (3 / 3)**

Pin No. (80-Pin LQFP)	Power Supply Clock System Control	I/O Port	Analog	Timer	Communi- cation	Interrupt	POE	Debugging
77		P60	AN0					
78		P55	AN11					
79		P54	AN10					
80		P53	AN9					
81		P52	AN8					
82		P51	AN7					
83		P50	AN6					
84		P47	AN103/ CVREFH					
85		P46	AN102					
86		P45	AN101					
87		P44	AN100					
88		P43	AN003/ CVREFL					
89		P42	AN002					
90		P41	AN001					
91		P40	AN000					
92	AVCC0							
93	VREFH0							
94	VREFL0							
95	AVSS0							
96		P82		MTIC5U	SCK2-B			
97		P81		MTIC5V	TXD2-B			
98		P80		MTIC5W	RXD2-B			
99		P11		MTCLKC-B		IRQ1-A		
100		P10		MTCLKD-B		IRQ0-A		

**Table 1.6 List of Pins and Pin Functions (80-Pin LQFP) (1 / 3)**

Pin No. (80-Pin LQFP)	Power Supply Clock System Control	I/O Port	Analog	Timer	Communi- cation	Interrupt	POE	Debugging
1	EMLE							
2	VSS							
3	MDE							
4	VCL							
5	MD1							
6	MD0							
7		PE4		MTCLKC-C		IRQ1-B	POE10#-B	
8		PE3		MTCLKD-C		IRQ2-A	POE11#	
9	RES#							
10	XTAL							
11	VSS							
12	EXTAL							
13	VCC							
14		PE2				NMI	POE10#-A	
15		PE0			CRX-C			
16		PD7		GTIOC0A-B	CTX-C			TRST#
17		PD6		GTIOC0B-B				TMS
18		PD5		GTIOC1A-B	RXD1			TDI
19		PD4		GTIOC1B-B	SCK1			TCK
20		PD3		GTIOC2A-B	TXD1			TDO
21		PB7			SCK2-A			
22		PB6			CRX-A/ RXD2-A			
23		PB5			CTX-A/ TXD2-A			
24	PLLVCC							
25		PB4		GTETRG		IRQ3	POE8#	
26	PLLSS							
27		PB3		MTIOC0A-A	SCK0			
28		PB2		MTIOC0B-A	TXD0/SDA			
29		PB1		MTIOC0C	RXD0/SCL			
30		PB0		MTIOC0D	MOSI-B			
31		PA3		MTIOC2A	SSL0-B			
32		PA2		MTIOC2B	SSL1-B			
33	VCC							
34		P96				IRQ4	POE4#	
35	VSS							
36		P95		MTIOC6B				
37		P94		MTIOC7A				
38		P93		MTIOC7B				
39		P92		MTIOC6D				
40		P91		MTIOC7C				
41		P76		MTIOC4D/ GTIOC2B-A				



**Table 1.6 List of Pins and Pin Functions (80-Pin LQFP) (2 / 3)**

Pin No. (80-Pin LQFP)	Power Supply Clock System Control	I/O Port	Analog	Timer	Communi- cation	Interrupt	POE	Debugging
42		P75		MTIOC4C/ GTIOC1B-A				
43		P74		MTIOC3D/ GTIOC0B-A				
44		P73		MTIOC4B/ GTIOC2A-A				
45		P72		MTIOC4A/ GTIOC1A-A				
46		P71		MTIOC3B/ GTIOC0A-A				
47		P70				IRQ5	POE0#	
48		P33		MTIOC3A/ MTCLKA-A	SSL3-A			
49		P32		MTIOC3C/ MTCLKB-A	SSL2-A			
50	VCC							
51		P31		MTIOC0A-B/ MTCLKC-A	SSL1-A			
52	VSS							
53		P30		MTIOC0B-B/ MTCLKD-A	SSL0-A			
54		P24			RSPCK-A			
55		P23			CTX-B/ LTX/ MOSI-A			
56		P22	ADTRG#		CRX-B/ LRX/ MISO-A			
57		P21	ADTRG1#-B	MTCLKA-B		IRQ6		
58		P20	ADTRG0#-B	MTCLKB-B		IRQ7		
59	AVCC							
60	AVSS							
61		P63	AN3					
62		P62	AN2					
63		P61	AN1					
64		P60	AN0					
65		P47	AN103/ CVREFH					
66		P46	AN102					
67		P45	AN101					
68		P44	AN100					
69		P43	AN003/ CVREFL					
70		P42	AN002					
71		P41	AN001					
72		P40	AN000					
73	AVCC0							
74	VREFH0							
75	VREFL0							

**Table 1.6 List of Pins and Pin Functions (80-Pin LQFP) (3 / 3)**

Pin No. (80-Pin LQFP)	Power Supply Clock System Control	I/O Port	Analog	Timer	Communi- cation	Interrupt	POE	Debugging
76	AVSS0							
77		P11		MTCLKC-B		IRQ1-A		
78		P10		MTCLKD-B		IRQ0-A		
79		PA5	ADTRG1#-A	MTIOC1A	MISO-B			
80		PA4	ADTRG0#-A	MTIOC1B	RSPCK-B			

**Table 1.7 List of Pins and Pin Functions (80-Pin LQFP: R5F562TxGDFF) (1 / 3)**

Pin No. (80-Pin LQFP)	Power Supply Clock System Control	I/O Port	Analog	Timer	Communication	Interrupt	POE	Debugging
1	EMLE							
2	VSS							
3	MDE							
4	VCL							
5	MD1							
6	MD0							
7		PE4		MTCLKC-C		IRQ1-B	POE10#-B	
8		PE3		MTCLKD-C		IRQ2-A	POE11#	
9	RES#							
10	XTAL							
11	VSS							
12	EXTAL							
13	VCC							
14		PE2				NMI	POE10#-A	
15		PD7		GTIOC0A-B				TRST#
16		PD6		GTIOC0B-B				TMS
17		PD5		GTIOC1A-B	RXD1			TDI
18		PD4		GTIOC1B-B	SCK1			TCK
19		PD3		GTIOC2A-B	TXD1			TDO
20		PD2		GTIOC2B-B				
21		PB7			SCK2-A			
22		PB6			CRX-A/ RXD2-A			
23		PB5			CTX-A/ TXD2-A			
24	PLLVCC							
25		PB4		GTETRGR		IRQ3	POE8#	
26	PLLVSS							
27		PB3		MTIOC0A-A	SCK0			
28		PB2		MTIOC0B-A	TXD0/SDA			
29		PB1		MTIOC0C	RXD0/SCL			
30		PB0		MTIOC0D				
31		PA5	ADTRG1#-A	MTIOC1A				
32		PA3		MTIOC2A				
33	VCC							
34		P96				IRQ4	POE4#	
35	VSS							
36		P95		MTIOC6B				
37		P94		MTIOC7A				
38		P93		MTIOC7B				
39		P92		MTIOC6D				
40		P91		MTIOC7C				
41		P90		MTIOC7D				

**Table 1.7 List of Pins and Pin Functions (80-Pin LQFP: R5F562TxGDFF) (2 / 3)**

Pin No. (80-Pin LQFP)	Power Supply Clock System Control	I/O Port	Analog	Timer	Communication	Interrupt	POE	Debugging
42		P76		MTIOC4D/ GTIOC2B-A				
43		P75		MTIOC4C/ GTIOC1B-A				
44		P74		MTIOC3D/ GTIOC0B-A				
45		P73		MTIOC4B/ GTIOC2A-A				
46		P72		MTIOC4A/ GTIOC1A-A				
47		P71		MTIOC3B/ GTIOC0A-A				
48		P70				IRQ5	POE0#	
49		P33		MTIOC3A/ MTCLKA-A	SSL3-A			
50		P32		MTIOC3C/ MTCLKB-A	SSL2-A			
51	VCC							
52		P31		MTIOC0A-B/ MTCLKC-A	SSL1-A			
53	VSS							
54		P30		MTIOC0B-B/ MTCLKD-A	SSL0-A			
55		P24			RSPCK-A			
56		P23			CTX-B/ LTX/ MOSI-A			
57		P22	ADTRG#		CRX-B/ LRX/ MISO-A			
58		P20	ADTRG0#-B	MTCLKB-B		IRQ7		
59	AVCC							
60	AVSS							
61		P63	AN3					
62		P62	AN2					
63		P61	AN1					
64		P60	AN0					
65		P47	AN103/ CVREFH					
66		P46	AN102					
67		P45	AN101					
68		P44	AN100					
69		P43	AN003/ CVREFL					
70		P42	AN002					
71		P41	AN001					
72		P40	AN000					
73	AVCC0							
74	VREFH0							
75	VREFL0							

**Table 1.7 List of Pins and Pin Functions (80-Pin LQFP: R5F562TxGDFF) (3 / 3)**

Pin No. (80-Pin LQFP)	Power Supply Clock System Control	I/O Port	Analog	Timer	Communication	Interrupt	POE	Debugging
76	AVSS0							
77		P82		MTIC5U	SCK2-B			
78		P81		MTIC5V	TXD2-B			
79		P80		MTIC5W	RXD2-B			
80		P10		MTCLKD-B		IRQ0-A		

**Table 1.8 List of Pins and Pin Functions (64-Pin LQFP) (1 / 2)**

Pin No. (64-Pin LQFP)	Power Supply Clock System Control	I/O Port	Analog	Timer	Communi- cation	Interrupt	POE	Debugging
1	EMLE							
2	MDE							
3	VCL							
4	MD1							
5	MD0							
6	RES#							
7	XTAL							
8	VSS							
9	EXTAL							
10	VCC							
11		PE2				NMI	POE10#-A	
12		PD7		GTIOC0A-B				TRST#
13		PD6		GTIOC0B-B				TMS
14		PD5		GTIOC1A-B	RXD1			TDI
15		PD4		GTIOC1B-B	SCK1			TCK
16		PD3		GTIOC2A-B	TXD1			TDO
17		PB7			SCK2-A			
18		PB6			CRX-A/ RXD2-A			
19		PB5			CTX-A/ TXD2-A			
20	PLLVCC							
21		PB4		GTETRQ		IRQ3	POE8#	
22	PLLVSS							
23		PB3		MTIOC0A-A	SCK0			
24		PB2		MTIOC0B-A	TXD0/SDA			
25		PB1		MTIOC0C	RXD0/SCL			
26		PB0		MTIOC0D	MOSI-B			
27		PA3		MTIOC2A	SSL0-B			
28		PA2		MTIOC2B	SSL1-B			
29		P94		MTIOC7A				
30		P93		MTIOC7B				
31		P92		MTIOC6D				
32		P91		MTIOC7C				
33		P76		MTIOC4D/ GTIOC2B-A				
34		P75		MTIOC4C/ GTIOC1B-A				
35		P74		MTIOC3D/ GTIOC0B-A				
36		P73		MTIOC4B/ GTIOC2A-A				
37		P72		MTIOC4A/ GTIOC1A-A				
38		P71		MTIOC3B/ GTIOC0A-A				
39		P70				IRQ5	POE0#	

**Table 1.8 List of Pins and Pin Functions (64-Pin LQFP) (2 / 2)**

Pin No. (64-Pin LQFP)	Power Supply Clock System Control	I/O Port	Analog	Timer	Communi- cation	Interrupt	POE	Debuggi ng
40		P33		MTIOC3A/ MTCLKA-A	SSL3-A			
41		P32		MTIOC3C/ MTCLKB-A	SSL2-A			
42	VCC							
43		P31		MTIOC0A-B/ MTCLKC-A	SSL1-A			
44	VSS							
45		P30		MTIOC0B-B/ MTCLKD-A	SSL0-A			
46		P24			RSPCK-A			
47		P23			CTX-B/ LTX/ MOSI-A			
48		P22			CRX-B/ LRX/ MISO-A			
49		P47	AN103/ CVREFH					
50		P46	AN102					
51		P45	AN101					
52		P44	AN100					
53		P43	AN003/ CVREFL					
54		P42	AN002					
55		P41	AN001					
56		P40	AN000					
57	AVCC0							
58	VREFH0							
59	VREFL0							
60	AVSS0							
61		P11		MTCLKC-B		IRQ1-A		
62		P10		MTCLKD-B		IRQ0-A		
63		PA5	ADTRG1#-A	MTIOC1A	MISO-B			
64		PA4	ADTRG0#-A	MTIOC1B	RSPCK-B			

## 1.5 Pin Functions

Table 1.9 lists the pin functions.

**Table 1.9 Pin Functions (1 / 4)**

Classifications	Pin Name	I/O	Description	
Power supply	VCC	Input	Power supply pin. Connect it to the system power supply.	
	VCL	Input	Connect this pin to VSS via a 0.1- $\mu$ F capacitor. The capacitor should be placed close to the pin.	
	VSS	Input	Ground pin. Connect it to the system power supply (0 V).	
	PLLVCC	Input	Power supply pin for the PLL circuit. Connect it to the system power supply.	
	PLLVSS	Input	Ground pin for the PLL circuit.	
Clock	XTAL	Output	Pins for a crystal resonator. An external clock signal can be input through the EXTAL pin.	
	EXTAL	Input		
Operating mode control	MD0 MD1 MDE	Input	Pins for setting the operating mode. The signal levels on these pins must not be changed during operation.	
System control	RES#	Input	Reset signal input pin. This LSI enters the reset state when this signal goes low.	
	EMLE	Input	Input pin for the on-chip emulator enable signal. When the on-chip emulator is used, this pin should be driven high. When not used, it should be driven low.	
On-chip emulator	TRST#	Input	On-chip emulator pins. When the EMLE pin is driven high, these pins are dedicated for the on-chip emulator.	
	TMS	Input		
	TDI	Input		
	TCK	Input		
	TDO	Output		
	TRCLK	Output		This pin outputs the clock for synchronization with the trace data. Not included in the 80-/64-pin versions.
	TRSYNC	Output		This pin indicates that output from the TRDATA0 to TRDATA3 pins is valid. Not included in the 80-/64-pin versions.
	TRDATA0 to TRDATA3	Output		These pins output the trace information. Not included in the 80-/64-pin versions.
Interrupt (ICU)	NMI	Input	Non-maskable interrupt request signal.	
	IRQ0-A/IRQ0-B/IRQ0-C IRQ1-A/IRQ1-B/IRQ1-C IRQ2-A/IRQ2-B IRQ3 to IRQ7	Input	Interrupt request signals. The IRQ0-C/IRQ1-C/IRQ2-B pin is not included in the 100-pin version. The IRQ0-B/IRQ1-C/IRQ2-B pin is not included in the 80-pin version. The IRQ0-B/IRQ0-C/IRQ1-B/IRQ1-/IRQ2-A/IRQ2-B/IRQ4/IRQ6/IRQ7 pin is not included in the 64-pin version.	



**Table 1.9 Pin Functions (2 / 4)**

Classifications	Pin Name	I/O	Description
Multi-function timer pulse unit 3 (MTU3)	MTIOC0A-A/MTIOC0A-B MTIOC0B-A/MTIOC0B-B MTIOC0C, MTIOC0D	I/O	The MTU0.TGRA to MTU0.TGRD input capture input/output compare output/PWM output pins.
	MTIOC1A, MTIOC1B	I/O	The MTU1.TGRA and MTU1.TGRB input capture input/output compare output/PWM output pins.
	MTIOC2A, MTIOC2B	I/O	The MTU2.TGRA and MTU2.TGRB input capture input/output compare output/PWM output pins.
	MTIOC3A, MTIOC3B MTIOC3C, MTIOC3D	I/O	The MTU3.TGRA and MTU3.TGRD input capture input/output compare output/PWM output pins. Pins MTIOC3B and MTIOC3D can be used for large-current output.
	MTIOC4A, MTIOC4B MTIOC4C, MTIOC4D	I/O	The MTU4.TGRA and MTU4.TGRD input capture input/output compare output/PWM output pins. These pins can be used for large-current output.
	MTIC5U, MTIC5V, MTIC5W	Input	The MTU5.TGRU, MTU5.TGRV, and MTU5.TGRW input capture input/dead time compensation input pins. Not included in the 80-/64-pin versions.
	MTIOC6A, MTIOC6B MTIOC6C, MTIOC6D	I/O	The MTU6.TGRA to MTU6.TGRD input capture input/output compare output/PWM output pins. Pins MTIOC6B and MTIOC6D can be used for large-current output. The MTIOC6A/MTIOC6C pin is not included in the 80-pin version. The MTIOC6A/MTIOC6B/MTIOC6C pin is not included in the 64-pin version.
	MTIOC7A, MTIOC7B MTIOC7C, MTIOC7D	I/O	The MTU7.TGRA to MTU7.TGRD input capture input/output compare output/PWM output pins. These pins can be used for large-current output. The MTIOC7D pin is not included in the 80-/64-pin versions.
General PWM timer (GPT)	MTCLKA-A/MTCLKA-B MTCLKB-A/MTCLKB-B MTCLKC-A/MTCLKC-B/ MTCLKC-C MTCLKD-A/MTCLKD-B/ MTCLKD-C	Input	Input pins for external clock signals. The MTCLKA-B/MTCLKB-B/MTCLKC-C/MTCLKD-C pin is not included in the 64-pin version.
	GTIOC0A-A/GTIOC0A-B GTIOC0B-A/GTIOC0B-B	I/O	The GPT0.GTCCRA and GPT0.GTCCRB CCRB input capture input/output compare output/PWM output pins. Pins GTIOC0A-A and GTIOC0B-A can be used for large-current output.
	GTIOC1A-A/GTIOC1A-B GTIOC1B-A/GTIOC1B-B	I/O	The GPT1.GTCCRA and GPT1.GTCCRB input capture input/output compare output/PWM output pins. Pins GTIOC1A-A and GTIOC1B-A can be used for large-current output.
	GTIOC2A-A/GTIOC2A-B GTIOC2B-A/GTIOC2B-B	I/O	The GPT2.GTCCRA and GPT2.GTCCRB input capture input/output compare output/PWM output pins. Pins GTIOC2A-A and GTIOC2B-A can be used for large-current output. The GTIOC2B-B pin is not included in the 80-pin version.
	GTIOC3A, GTIOC3B	I/O	The GPT3.GTCCRA and GPT3.GTCCRB input capture input/output compare output/PWM output pins. Not included in the 80-/64-pin versions.
Port output enable 3 (POE3)	GTETRQ	Input	External trigger input pin for the GPT
	POE0#, POE4#, POE8# POE10#-A/POE10#-B POE11#	Input	Input pins for request signals to place the MTU3 and GPT large-current pins in the high impedance state. The POE4#/ POE10#-B/POE11# pin is not included in the 64-pin version.
Watchdog timer (WDT)	WDTOVF#	Output	Output pin for the counter-overflow signal in watchdog-timer mode. Not included in the 100-/80-/64-pin versions.

**Table 1.9 Pin Functions (3 / 4)**

Classifications	Pin Name	I/O	Description
Serial communications interface (SCIb)	TXD0, TXD1, TXD2-A/TXD2-B	Output	Output pins for data transmission. The TXD2-B pin is not included in the 80-/64-pin versions.
	RXD0, RXD1, RXD2-A/RXD2-B	Input	Input pins for data reception. The RXD2-B pin is not included in the 80-/64-pin versions.
	SCK0, SCK1, SCK2-A/SCK2-B	I/O	Input/output pins for clock signals. The SCK2-B pin is not included in the 80-/64-pin versions.
I <sup>2</sup> C bus interface (RIIC)	SCL	I/O	Input/output pin for I <sup>2</sup> C bus interface clocks. Bus can be directly driven by the NMOS open drain output.
	SDA	I/O	Input/output pin for I <sup>2</sup> C bus interface data. Bus can be directly driven by the NMOS open drain output.
CAN module (CAN) (as an optional function)	CRX-A/CRX-B/CRX-C	Input	Input pin for the CAN. The CRX-C pin is not included in the 64-pin version.
	CTX-A/CTX-B/CTX-C	Output	Output pin for the CAN. The CTX-C pin is not included in the 64-pin version.
LIN module (LIN)	LRX	Input	Input pin for the LIN.
	LTX	Output	Output pin for the LIN.
Serial peripheral interface (RSPI)	RSPCK-A/RSPCK-B/RSPCK-C	I/O	Clock input/output pin for the RSPI. The RSPCK-C pin is not included in the 80-/64-pin versions.
	MOSI-A/MOSI-B/MOSI-C	I/O	Inputs or outputs data output from the master for the RSPI. The MOSI-C pin is not included in the 80-/64-pin versions.
	MISO-A/MISO-B/MISO-C	I/O	Inputs or outputs data output from the slave for the RSPI. The MISO-C pin is not included in the 80-/64-pin versions.
	SSL0-A/SSL0-B/SSL0-C	I/O	Select the slave for the RSPI. The SSL0-C/SSL1-C/SSL2-C/SSL3-C pin is not included in the 80-/64-pin versions.
	SSL1-A/SSL1-B/SSL1-C SSL2-A/SSL2-B/SSL2-C SSL3-A/SSL3-B/SSL3-C	Output	
A/D converter	AN000 to AN003 AN100 to AN103	Input	Input pins for the analog signals to be processed by the 12-bit A/D converter.
	AN0 to AN11	Input	Input pins for the analog signals to be processed by the 10-bit A/D converter. The AN4 to AN11 pins are not included in the 80-pin version. Not included in the 64-pin version.
	ADTRG0#-A/ADTRG0#-B ADTRG1#-A/ADTRG1#-B ADTRG#	Input	Input pins for the external trigger signals that start the A/D conversion. The ADTRG0#-B/ADTRG1#-B/ADTRG# pin is not included in the 64-pin version.
	CVREFH	Input	Input pin for the high-level reference voltage to the comparator
	CVREFL	Input	Input pin for the low-level reference voltage to the comparator
	Analog power supply	AVCC0	Input
AVSS0		Input	Ground pin for the 12-bit A/D converter. Connect this pin to the system power supply (0 V).
VREFH0		Input	Reference power supply pin for the 12-bit A/D converter. When the 12-bit A/D converter is not in use, connect this pin to the system power supply.
VREFL0		Input	Ground pin of the reference power supply pin for the 12-bit A/D converter. When the 12-bit A/D converter is not in use, connect this pin to the system power supply (0 V).
AVCC		Input	Analog power supply pin for the 10-bit A/D converter. When the A/D converter is not in use, connect this pin to the system power supply. Not included in the 64-pin version.
AVSS		Input	Ground pin for the 10-bit A/D converter. Connect this pin to the system power supply (0 V). Not included in the 64-pin version.
VREF		Input	Reference power supply pin for the 10-bit A/D converter. When the 10-bit A/D converter is not in use, connect this pin to the system power supply. Not included in the 80-/64-pin versions.

**Table 1.9 Pin Functions (4 / 4)**

Classifications	Pin Name	I/O	Description
I/O ports	P10, P11	I/O	2-bit input/output pins.
	P20 to P24	I/O	5-bit input/output pins. The P20/P21 pin is not included in the 64-pin version.
	P30 to P33	I/O	4-bit input/output pins.
	P40 to P47	Input	8-bit input pins.
	P50 to P55	Input	6-bit input pins. Not included in the 80-/64-pin versions.
	P60 to P65	Input	6-bit input pins. The P64/P6 pin is not included in the 80-pin version. Not included in the 64-pin version.
	P70 to P76	I/O	7-bit input/output pins.
	P80 to P82	I/O	3-bit input/output pins. Not included in the 80-/64-pin versions.
	P90 to P96	I/O	7-bit input/output pins. The P90 pin is not included in the 80-pin version. The P90/P95/P96 pin is not included in the 64-pin version.
	PA0 to PA5	I/O	6-bit input/output pins. The PA0/PA1 pin is not included in the 80-/64-pin versions.
	PB0 to PB7	I/O	8-bit input/output pins.
	PD0 to PD7	I/O	8-bit input/output pins. The PD0/PD1/PD2 pin is not included in the 80-/64-pin versions.
	PE0, PE1, PE3 to PE5	I/O	5-bit input/output pins. The PE1/PE5 pin is not included in the 80-pin version. Not included in the 64-pin version.
	PE2	Input	1-bit input pin.
	PG0 to PG5	I/O	6-bit input/output pins. Not included in the 100-/80-/64-pin versions.

Note: • Which pins are and are not incorporated depends on the package.  
For details, see the list of pins and pin functions in Table 1.4 to Table 1.8.

## 2. CPU

The RX CPU has sixteen general-purpose registers, nine control registers, and one accumulator used for DSP instructions.



Figure 2.1 Register Set of the CPU

## 2.1 General-Purpose Registers (R0 to R15)

This CPU has sixteen general-purpose registers (R0 to R15). R1 to R15 can be used as data registers or address registers. R0, a general-purpose register, also functions as the stack pointer (SP). The stack pointer is switched to operate as the interrupt stack pointer (ISP) or user stack pointer (USP) by the value of the stack pointer select bit (U) in the processor status word (PSW).

## 2.2 Control Registers

### (1) Interrupt Stack Pointer (ISP)/User Stack Pointer (USP)

The stack pointer (SP) can be either of two types, the interrupt stack pointer (ISP) or the user stack pointer (USP). Whether the stack pointer operates as the ISP or USP depends on the value of the stack pointer select bit (U) in the processor status word (PSW).

Set the ISP or USP to a multiple of four, as this reduces the numbers of cycles required to execute interrupt sequences and instructions entailing stack manipulation.

### (2) Interrupt Table Register (INTB)

The interrupt table register (INTB) specifies the address where the relocatable vector table starts. Set INTB to a multiple of four.

### (3) Program Counter (PC)

The program counter (PC) indicates the address of the instruction being executed.

### (4) Processor Status Word (PSW)

The processor status word (PSW) indicates results of instruction execution or the state of the CPU.

### (5) Backup PC (BPC)

The backup PC (BPC) is provided to speed up response to interrupts.

After a fast interrupt has been generated, the contents of the program counter (PC) are saved in the BPC.

### (6) Backup PSW (BPSW)

The backup PSW (BPSW) is provided to speed up response to interrupts.

After a fast interrupt has been generated, the contents of the processor status word (PSW) are saved in the BPSW. The allocation of bits in the BPSW corresponds to that in the PSW.

### (7) Fast Interrupt Vector Register (FINTV)

The fast interrupt vector register (FINTV) is provided to speed up response to interrupts.

The FINTV register specifies a branch destination address when a fast interrupt has been generated.

### (8) Floating-Point Status Word (FPSW)

The floating-point status word (FPSW) indicates the results of floating-point operations.

When an exception handling enable bit (Ej) enables the exception handling (Ej = 1), the exception cause can be identified by checking the corresponding Cj flag in the exception handling routine. If the exception handling is masked (Ej = 0), the occurrence of exception can be checked by reading the Fj flag at the end of a series of processing. Once the Fj flag has been set to 1, this value is retained until it is cleared to 0 by software (j = X, U, Z, O, or V).

### (9) Accumulator (ACC)

The accumulator (ACC) is a 64-bit register used for DSP instructions. The accumulator is also used for the multiply and multiply-and-accumulate instructions; EMUL, EMULU, FMUL, MUL, and RMPA, in which case the prior value in the accumulator is modified by execution of the instruction.

Use the MVTACHI and MVTACLO instructions for writing to the accumulator. The MVTACHI and MVTACLO instructions write data to the higher-order 32 bits (bits 63 to 32) and the lower-order 32 bits (bits 31 to 0), respectively. Use the MVFACHI and MVFACMI instructions for reading data from the accumulator. The MVFACHI and MVFACMI instructions read data from the higher-order 32 bits (bits 63 to 32) and the middle 32 bits (bits 47 to 16), respectively.

### 3. Address Space

#### 3.1 Address Space

This LSI has a 4-Gbyte address space, consisting of the range of addresses from 0000 0000h to FFFF FFFFh. That is, linear access to an address space of up to 4 Gbytes is possible, and this contains both program and data areas.

Figure 3.1 shows the memory maps.

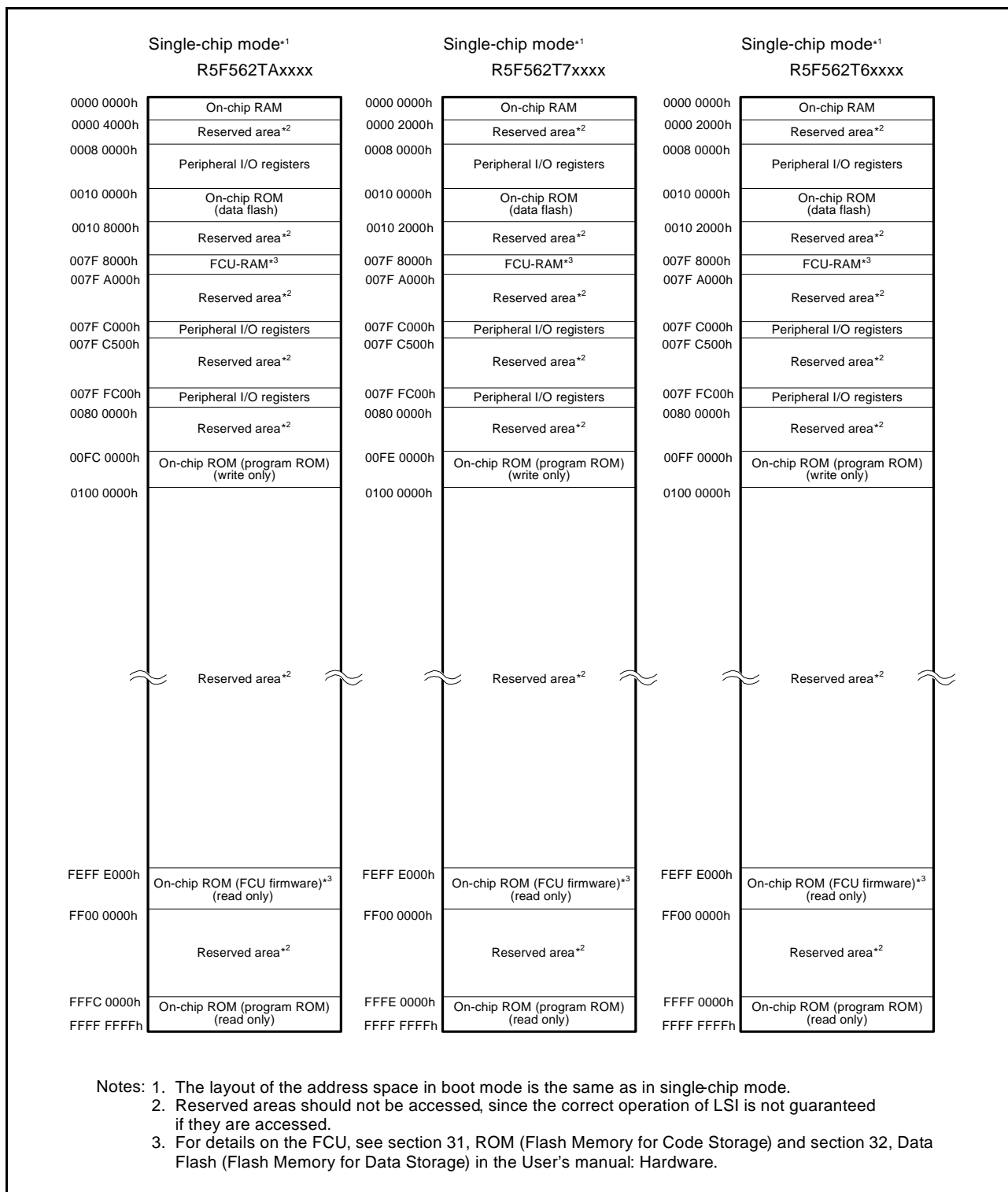

Figure 3.1 Memory Map (RX62T Group)

## 4. I/O Registers

This section gives information on the on-chip I/O register addresses and bit configurations. The information is given as shown below. Notes on writing to registers are also given at the end.

### (1) I/O register addresses (address order)

- Registers are listed from the lower allocation addresses.
- Registers are classified according to functional modules (abbreviations).
- The number of access cycles indicates the number of states based on the specified reference clock.
- Among the I/O register area, addresses not listed in the list of registers are reserved. Reserved addresses must not be accessed. Do not access these addresses; otherwise, the operation when accessing these bits and subsequent operations cannot be guaranteed.
- A unit of access is specified for each register. Access other than in the specified unit is prohibited.

### (2) I/O register bits

- Bit configurations of the registers are listed in the same order as the register addresses.
- Reserved bits are indicated by "-" in the bit name column.
- Space in the bit name field indicates that the entire register is allocated to either the counter or data.
- For the registers of 16 or 32 bits, the MSB is listed first.

### (3) Notes on writing to I/O registers

When writing to an I/O register, the CPU starts executing the subsequent instruction before completing I/O register write. This may cause the subsequent instruction to be executed before the post-update I/O register value is reflected on the operation.

As described in the following examples, special care is required for the cases in which the subsequent instruction must be executed after the post-update I/O register value is actually reflected.

[Examples of cases requiring special care]

- The subsequent instruction must be executed while an interrupt request is disabled with the IEN<sub>j</sub> bit in IER<sub>m</sub> of the ICU (interrupt request enable bit)\*1 cleared to 0.
- A WAIT instruction is executed immediately after the preprocessing for causing a transition to the low power consumption state.

Note 1. See section 11.2.2, Interrupt Request Enable Register m (IER<sub>m</sub>) (m = 02h to 1Fh) in the User's manual: Hardware.

In the above cases, after writing to an I/O register, wait until the write operation is completed using the following procedure and then execute the subsequent instruction.



- (a) Write to an I/O register.
- (b) Read the value from the I/O register to a general register.
- (c) Execute the operation using the value read.
- (d) Execute the subsequent instruction.

[Instruction examples]

- Byte-size I/O registers

```
MOV.L #SFR_ADDR, R1
MOV.B #SFR_DATA, [R1]
CMP [R1].UB, R1
;; Next process
```

- Word-size I/O registers

```
MOV.L #SFR_ADDR, R1
MOV.W #SFR_DATA, [R1]
CMP [R1].W, R1
;; Next process
```

- Longword-size I/O registers

```
MOV.L #SFR_ADDR, R1
MOV.L #SFR_DATA, [R1]
CMP [R1].L, R1
;; Next process
```

If multiple registers are written to and a subsequent instruction should be executed after the write operations are entirely completed, only read the I/O register that was last written to and execute the operation using the value; it is not necessary to read or execute operation for all the registers that were written to.

#### (4) Number of Access Cycles to I/O Registers

The number of access cycles to I/O registers is obtained by following equation.\*

$$\begin{aligned} \text{Number of access cycles to I/O registers} = & \text{Number of bus cycles for internal main bus 1} + \\ & \text{Number of divided cycles for clock synchronization} + \\ & \text{Number of bus cycles for internal peripheral buses 1, 2, 4, and 6} \end{aligned}$$

The number of bus cycles for internal peripheral buses 1, 2, 4, and 6 differs according to the register to be accessed. For the number of access cycles to each I/O register, see **Table 4.1, List of I/O Registers**.

When peripheral functions connected to internal peripheral bus 6 are accessed, the number of divided cycles for clock synchronization is added.

Although the number of divided cycles for clock synchronization differs depending on the number of frequency ratio between ICLK and PCLK or bus access timing, the sum of the number of bus cycles for internal main bus 1 and the number of divided cycles for clock synchronization will be one PCLK at a maximum. Therefore, one PCLK is added to the number of access cycles shown in **Table 4.1**.

Note: • This applies to the number of cycles when the access from the CPU does not conflict with the instruction fetching to the external memory or bus access from the different bus master (DTC).

## 4.1 I/O Register Addresses (Address Order)

Table 4.1 List of I/O Registers (Address Order) (1 / 25)

Address	Module Abbreviation	Register Name	Register Abbreviation	Number of Bits	Access Size	Number of Access Cycles
0008 0000h	SYSTEM	Mode monitor register	MDMONR	16	16	3 ICLK
0008 0002h	SYSTEM	Mode status register	MDSR	16	16	3 ICLK
0008 0006h	SYSTEM	System control register 0	SYSCR0	16	16	3 ICLK
0008 0008h	SYSTEM	System control register 1	SYSCR1	16	16	3 ICLK
0008 000Ch	SYSTEM	Standby control register	SBYCR	16	16	3 ICLK
0008 0010h	SYSTEM	Module stop control register A	MSTPCRA	32	32	3 ICLK
0008 0014h	SYSTEM	Module stop control register B	MSTPCRB	32	32	3 ICLK
0008 0018h	SYSTEM	Module stop control register C	MSTPCRC	32	32	3 ICLK
0008 0020h	SYSTEM	System clock control register	SCKCR	32	32	3 ICLK
0008 0040h	SYSTEM	Oscillation stop detection control register	OSTDCR	16	16	3 ICLK
0008 1300h	BSC	Bus error status clear register	BERCLR	8	8	2 ICLK
0008 1304h	BSC	Bus error monitoring enable register	BEREN	8	8	2 ICLK
0008 1308h	BSC	Bus error status register 1	BERSR1	8	8	2 ICLK
0008 130Ah	BSC	Bus error status register 2	BERSR2	16	16	2 ICLK
0008 2400h	DTC	DTC control register	DTCCR	8	8	2 ICLK
0008 2404h	DTC	DTC vector base register	DTCVBR	32	32	2 ICLK
0008 2408h	DTC	DTC address mode register	DTCADMOD	8	8	2 ICLK
0008 240Ch	DTC	DTC module start register	DTCST	8	8	2 ICLK
0008 240Eh	DTC	DTC status register	DTCSTS	16	16	2 ICLK
0008 6400h	MPU	Region 0 start page-number register	RSPAGE0	32	32	1 ICLK
0008 6404h	MPU	Region 0 end page-number register	REPAGE0	32	32	1 ICLK
0008 6408h	MPU	Region 1 start page-number register	RSPAGE1	32	32	1 ICLK
0008 640Ch	MPU	Region 1 end page-number register	REPAGE1	32	32	1 ICLK
0008 6410h	MPU	Region 2 start page-number register	RSPAGE2	32	32	1 ICLK
0008 6414h	MPU	Region 2 end page-number register	REPAGE2	32	32	1 ICLK
0008 6418h	MPU	Region 3 start page-number register	RSPAGE3	32	32	1 ICLK
0008 641Ch	MPU	Region 3 end page-number register	REPAGE3	32	32	1 ICLK
0008 6420h	MPU	Region 4 start page-number register	RSPAGE4	32	32	1 ICLK
0008 6424h	MPU	Region 4 end page-number register	REPAGE4	32	32	1 ICLK
0008 6428h	MPU	Region 5 start page-number register	RSPAGE5	32	32	1 ICLK
0008 642Ch	MPU	Region 5 end page-number register	REPAGE5	32	32	1 ICLK
0008 6430h	MPU	Region 6 start page-number register	RSPAGE6	32	32	1 ICLK
0008 6434h	MPU	Region 6 end page-number register	REPAGE6	32	32	1 ICLK
0008 6438h	MPU	Region 7 start page-number register	RSPAGE7	32	32	1 ICLK
0008 643Ch	MPU	Region 7 end page-number register	REPAGE7	32	32	1 ICLK
0008 6500h	MPU	Memory-protection enable register	MPEN	32	32	1 ICLK
0008 6504h	MPU	Background access control register	MPBAC	32	32	1 ICLK
0008 6508h	MPU	Memory-protection error status-clearing register	MPECLR	32	32	1 ICLK
0008 650Ch	MPU	Memory-protection error status register	MPESTS	32	32	1 ICLK
0008 6514h	MPU	Data memory-protection error address register	MPDEA	32	32	1 ICLK
0008 6520h	MPU	Region search address register	MPSA	32	32	1 ICLK
0008 6524h	MPU	Region search operation register	MPOPS	16	16	1 ICLK

**Table 4.1 List of I/O Registers (Address Order) (2 / 25)**

Address	Module Abbreviation	Register Name	Register Abbreviation	Number of Bits	Access Size	Number of Access Cycles
0008 6526h	MPU	Region invalidation operation register	MPOPI	16	16	1 ICLK
0008 6528h	MPU	Instruction-hit region register	MHITI	32	32	1 ICLK
0008 652Ch	MPU	Data-hit region register	MHITD	32	32	1 ICLK
0008 7010h	ICU	Interrupt request register 016	IR016	8	8	2 ICLK
0008 7015h	ICU	Interrupt request register 021	IR021	8	8	2 ICLK
0008 7017h	ICU	Interrupt request register 023	IR023	8	8	2 ICLK
0008 701Bh	ICU	Interrupt request register 027	IR027	8	8	2 ICLK
0008 701Ch	ICU	Interrupt request register 028	IR028	8	8	2 ICLK
0008 701Dh	ICU	Interrupt request register 029	IR029	8	8	2 ICLK
0008 701Eh	ICU	Interrupt request register 030	IR030	8	8	2 ICLK
0008 701Fh	ICU	Interrupt request register 031	IR031	8	8	2 ICLK
0008 702Ch	ICU	Interrupt request register 044	IR044	8	8	2 ICLK
0008 702Dh	ICU	Interrupt request register 045	IR045	8	8	2 ICLK
0008 702Eh	ICU	Interrupt request register 046	IR046	8	8	2 ICLK
0008 702Fh	ICU	Interrupt request register 047	IR047	8	8	2 ICLK
0008 7038h	ICU	Interrupt request register 056	IR056	8	8	2 ICLK
0008 7039h	ICU	Interrupt request register 057	IR057	8	8	2 ICLK
0008 703Ah	ICU	Interrupt request register 058	IR058	8	8	2 ICLK
0008 703Bh	ICU	Interrupt request register 059	IR059	8	8	2 ICLK
0008 703Ch	ICU	Interrupt request register 060	IR060	8	8	2 ICLK
0008 7040h	ICU	Interrupt request register 064	IR064	8	8	2 ICLK
0008 7041h	ICU	Interrupt request register 065	IR065	8	8	2 ICLK
0008 7042h	ICU	Interrupt request register 066	IR066	8	8	2 ICLK
0008 7043h	ICU	Interrupt request register 067	IR067	8	8	2 ICLK
0008 7044h	ICU	Interrupt request register 068	IR068	8	8	2 ICLK
0008 7045h	ICU	Interrupt request register 069	IR069	8	8	2 ICLK
0008 7046h	ICU	Interrupt request register 070	IR070	8	8	2 ICLK
0008 7047h	ICU	Interrupt request register 071	IR071	8	8	2 ICLK
0008 7060h	ICU	Interrupt request register 096	IR096	8	8	2 ICLK
0008 7062h	ICU	Interrupt request register 098	IR098	8	8	2 ICLK
0008 7066h	ICU	Interrupt request register 102	IR102	8	8	2 ICLK
0008 7067h	ICU	Interrupt request register 103	IR103	8	8	2 ICLK
0008 706Ah	ICU	Interrupt request register 106	IR106	8	8	2 ICLK
0008 7072h	ICU	Interrupt request register 114	IR114	8	8	2 ICLK
0008 7073h	ICU	Interrupt request register 115	IR115	8	8	2 ICLK
0008 7074h	ICU	Interrupt request register 116	IR116	8	8	2 ICLK
0008 7075h	ICU	Interrupt request register 117	IR117	8	8	2 ICLK
0008 7076h	ICU	Interrupt request register 118	IR118	8	8	2 ICLK
0008 7077h	ICU	Interrupt request register 119	IR119	8	8	2 ICLK
0008 7078h	ICU	Interrupt request register 120	IR120	8	8	2 ICLK
0008 7079h	ICU	Interrupt request register 121	IR121	8	8	2 ICLK
0008 707Ah	ICU	Interrupt request register 122	IR122	8	8	2 ICLK
0008 707Bh	ICU	Interrupt request register 123	IR123	8	8	2 ICLK
0008 707Ch	ICU	Interrupt request register 124	IR124	8	8	2 ICLK

**Table 4.1 List of I/O Registers (Address Order) (3 / 25)**

Address	Module Abbreviation	Register Name	Register Abbreviation	Number of Bits	Access Size	Number of Access Cycles
0008 707Dh	ICU	Interrupt request register 125	IR125	8	8	2 ICLK
0008 707Eh	ICU	Interrupt request register 126	IR126	8	8	2 ICLK
0008 707Fh	ICU	Interrupt request register 127	IR127	8	8	2 ICLK
0008 7080h	ICU	Interrupt request register 128	IR128	8	8	2 ICLK
0008 7081h	ICU	Interrupt request register 129	IR129	8	8	2 ICLK
0008 7082h	ICU	Interrupt request register 130	IR130	8	8	2 ICLK
0008 7083h	ICU	Interrupt request register 131	IR131	8	8	2 ICLK
0008 7084h	ICU	Interrupt request register 132	IR132	8	8	2 ICLK
0008 7085h	ICU	Interrupt request register 133	IR133	8	8	2 ICLK
0008 7086h	ICU	Interrupt request register 134	IR134	8	8	2 ICLK
0008 7087h	ICU	Interrupt request register 135	IR135	8	8	2 ICLK
0008 7088h	ICU	Interrupt request register 136	IR136	8	8	2 ICLK
0008 7089h	ICU	Interrupt request register 137	IR137	8	8	2 ICLK
0008 708Ah	ICU	Interrupt request register 138	IR138	8	8	2 ICLK
0008 708Bh	ICU	Interrupt request register 139	IR139	8	8	2 ICLK
0008 708Ch	ICU	Interrupt request register 140	IR140	8	8	2 ICLK
0008 708Dh	ICU	Interrupt request register 141	IR141	8	8	2 ICLK
0008 708Eh	ICU	Interrupt request register 142	IR142	8	8	2 ICLK
0008 708Fh	ICU	Interrupt request register 143	IR143	8	8	2 ICLK
0008 7090h	ICU	Interrupt request register 144	IR144	8	8	2 ICLK
0008 7091h	ICU	Interrupt request register 145	IR145	8	8	2 ICLK
0008 7092h	ICU	Interrupt request register 146	IR146	8	8	2 ICLK
0008 7095h	ICU	Interrupt request register 149	IR149	8	8	2 ICLK
0008 7096h	ICU	Interrupt request register 150	IR150	8	8	2 ICLK
0008 7097h	ICU	Interrupt request register 151	IR151	8	8	2 ICLK
0008 7098h	ICU	Interrupt request register 152	IR152	8	8	2 ICLK
0008 7099h	ICU	Interrupt request register 153	IR153	8	8	2 ICLK
0008 70AAh	ICU	Interrupt request register 170	IR170	8	8	2 ICLK
0008 70ABh	ICU	Interrupt request register 171	IR171	8	8	2 ICLK
0008 70ACh	ICU	Interrupt request register 172	IR172	8	8	2 ICLK
0008 70ADh	ICU	Interrupt request register 173	IR173	8	8	2 ICLK
0008 70AEh	ICU	Interrupt request register 174	IR174	8	8	2 ICLK
0008 70AFh	ICU	Interrupt request register 175	IR175	8	8	2 ICLK
0008 70B0h	ICU	Interrupt request register 176	IR176	8	8	2 ICLK
0008 70B1h	ICU	Interrupt request register 177	IR177	8	8	2 ICLK
0008 70B2h	ICU	Interrupt request register 178	IR178	8	8	2 ICLK
0008 70B3h	ICU	Interrupt request register 179	IR179	8	8	2 ICLK
0008 70B4h	ICU	Interrupt request register 180	IR180	8	8	2 ICLK
0008 70B5h	ICU	Interrupt request register 181	IR181	8	8	2 ICLK
0008 70B6h	ICU	Interrupt request register 182	IR182	8	8	2 ICLK
0008 70B7h	ICU	Interrupt request register 183	IR183	8	8	2 ICLK
0008 70B8h	ICU	Interrupt request register 184	IR184	8	8	2 ICLK
0008 70BAh	ICU	Interrupt request register 186	IR186	8	8	2 ICLK
0008 70BBh	ICU	Interrupt request register 187	IR187	8	8	2 ICLK

**Table 4.1 List of I/O Registers (Address Order) (4 / 25)**

Address	Module Abbreviation	Register Name	Register Abbreviation	Number of Bits	Access Size	Number of Access Cycles
0008 70BCh	ICU	Interrupt request register 188	IR188	8	8	2 ICLK
0008 70BDh	ICU	Interrupt request register 189	IR189	8	8	2 ICLK
0008 70BEh	ICU	Interrupt request register 190	IR190	8	8	2 ICLK
0008 70C0h	ICU	Interrupt request register 192	IR192	8	8	2 ICLK
0008 70C1h	ICU	Interrupt request register 193	IR193	8	8	2 ICLK
0008 70C2h	ICU	Interrupt request register 194	IR194	8	8	2 ICLK
0008 70C3h	ICU	Interrupt request register 195	IR195	8	8	2 ICLK
0008 70C4h	ICU	Interrupt request register 196	IR196	8	8	2 ICLK
0008 70D6h	ICU	Interrupt request register 214	IR214	8	8	2 ICLK
0008 70D7h	ICU	Interrupt request register 215	IR215	8	8	2 ICLK
0008 70D8h	ICU	Interrupt request register 216	IR216	8	8	2 ICLK
0008 70D9h	ICU	Interrupt request register 217	IR217	8	8	2 ICLK
0008 70DAh	ICU	Interrupt request register 218	IR218	8	8	2 ICLK
0008 70DBh	ICU	Interrupt request register 219	IR219	8	8	2 ICLK
0008 70DCh	ICU	Interrupt request register 220	IR220	8	8	2 ICLK
0008 70DDh	ICU	Interrupt request register 221	IR221	8	8	2 ICLK
0008 70DEh	ICU	Interrupt request register 222	IR222	8	8	2 ICLK
0008 70DFh	ICU	Interrupt request register 223	IR223	8	8	2 ICLK
0008 70E0h	ICU	Interrupt request register 224	IR224	8	8	2 ICLK
0008 70E1h	ICU	Interrupt request register 225	IR225	8	8	2 ICLK
0008 70F6h	ICU	Interrupt request register 246	IR246	8	8	2 ICLK
0008 70F7h	ICU	Interrupt request register 247	IR247	8	8	2 ICLK
0008 70F8h	ICU	Interrupt request register 248	IR248	8	8	2 ICLK
0008 70F9h	ICU	Interrupt request register 249	IR249	8	8	2 ICLK
0008 70FEh	ICU	Interrupt request register 254	IR254	8	8	2 ICLK
0008 711Bh	ICU	DTC activation enable register 027	DTCER027	8	8	2 ICLK
0008 711Ch	ICU	DTC activation enable register 028	DTCER028	8	8	2 ICLK
0008 711Dh	ICU	DTC activation enable register 029	DTCER029	8	8	2 ICLK
0008 711Eh	ICU	DTC activation enable register 030	DTCER030	8	8	2 ICLK
0008 711Fh	ICU	DTC activation enable register 031	DTCER031	8	8	2 ICLK
0008 712Dh	ICU	DTC activation enable register 045	DTCER045	8	8	2 ICLK
0008 712Eh	ICU	DTC activation enable register 046	DTCER046	8	8	2 ICLK
0008 7140h	ICU	DTC activation enable register 064	DTCER064	8	8	2 ICLK
0008 7141h	ICU	DTC activation enable register 065	DTCER065	8	8	2 ICLK
0008 7142h	ICU	DTC activation enable register 066	DTCER066	8	8	2 ICLK
0008 7143h	ICU	DTC activation enable register 067	DTCER067	8	8	2 ICLK
0008 7144h	ICU	DTC activation enable register 068	DTCER068	8	8	2 ICLK
0008 7145h	ICU	DTC activation enable register 069	DTCER069	8	8	2 ICLK
0008 7146h	ICU	DTC activation enable register 070	DTCER070	8	8	2 ICLK
0008 7147h	ICU	DTC activation enable register 071	DTCER071	8	8	2 ICLK
0008 7162h	ICU	DTC activation enable register 098	DTCER098	8	8	2 ICLK
0008 7166h	ICU	DTC activation enable register 102	DTCER102	8	8	2 ICLK
0008 7167h	ICU	DTC activation enable register 103	DTCER103	8	8	2 ICLK
0008 716Ah	ICU	DTC activation enable register 106	DTCER106	8	8	2 ICLK

**Table 4.1 List of I/O Registers (Address Order) (5 / 25)**

Address	Module Abbreviation	Register Name	Register Abbreviation	Number of Bits	Access Size	Number of Access Cycles
0008 7172h	ICU	DTC activation enable register 114	DTCER114	8	8	2 ICLK
0008 7173h	ICU	DTC activation enable register 115	DTCER115	8	8	2 ICLK
0008 7174h	ICU	DTC activation enable register 116	DTCER116	8	8	2 ICLK
0008 7175h	ICU	DTC activation enable register 117	DTCER117	8	8	2 ICLK
0008 7179h	ICU	DTC activation enable register 121	DTCER121	8	8	2 ICLK
0008 717Ah	ICU	DTC activation enable register 122	DTCER122	8	8	2 ICLK
0008 717Dh	ICU	DTC activation enable register 125	DTCER125	8	8	2 ICLK
0008 717Eh	ICU	DTC activation enable register 126	DTCER126	8	8	2 ICLK
0008 7181h	ICU	DTC activation enable register 129	DTCER129	8	8	2 ICLK
0008 7182h	ICU	DTC activation enable register 130	DTCER130	8	8	2 ICLK
0008 7183h	ICU	DTC activation enable register 131	DTCER131	8	8	2 ICLK
0008 7184h	ICU	DTC activation enable register 132	DTCER132	8	8	2 ICLK
0008 7186h	ICU	DTC activation enable register 134	DTCER134	8	8	2 ICLK
0008 7187h	ICU	DTC activation enable register 135	DTCER135	8	8	2 ICLK
0008 7188h	ICU	DTC activation enable register 136	DTCER136	8	8	2 ICLK
0008 7189h	ICU	DTC activation enable register 137	DTCER137	8	8	2 ICLK
0008 718Ah	ICU	DTC activation enable register 138	DTCER138	8	8	2 ICLK
0008 718Bh	ICU	DTC activation enable register 139	DTCER139	8	8	2 ICLK
0008 718Ch	ICU	DTC activation enable register 140	DTCER140	8	8	2 ICLK
0008 718Dh	ICU	DTC activation enable register 141	DTCER141	8	8	2 ICLK
0008 718Eh	ICU	DTC activation enable register 142	DTCER142	8	8	2 ICLK
0008 718Fh	ICU	DTC activation enable register 143	DTCER143	8	8	2 ICLK
0008 7190h	ICU	DTC activation enable register 144	DTCER144	8	8	2 ICLK
0008 7191h	ICU	DTC activation enable register 145	DTCER145	8	8	2 ICLK
0008 7195h	ICU	DTC activation enable register 149	DTCER149	8	8	2 ICLK
0008 7196h	ICU	DTC activation enable register 150	DTCER150	8	8	2 ICLK
0008 7197h	ICU	DTC activation enable register 151	DTCER151	8	8	2 ICLK
0008 7198h	ICU	DTC activation enable register 152	DTCER152	8	8	2 ICLK
0008 7199h	ICU	DTC activation enable register 153	DTCER153	8	8	2 ICLK
0008 71AEh	ICU	DTC activation enable register 174	DTCER174	8	8	2 ICLK
0008 71AFh	ICU	DTC activation enable register 175	DTCER175	8	8	2 ICLK
0008 71B0h	ICU	DTC activation enable register 176	DTCER176	8	8	2 ICLK
0008 71B1h	ICU	DTC activation enable register 177	DTCER177	8	8	2 ICLK
0008 71B2h	ICU	DTC activation enable register 178	DTCER178	8	8	2 ICLK
0008 71B3h	ICU	DTC activation enable register 179	DTCER179	8	8	2 ICLK
0008 71B4h	ICU	DTC activation enable register 180	DTCER180	8	8	2 ICLK
0008 71B5h	ICU	DTC activation enable register 181	DTCER181	8	8	2 ICLK
0008 71B6h	ICU	DTC activation enable register 182	DTCER182	8	8	2 ICLK
0008 71B7h	ICU	DTC activation enable register 183	DTCER183	8	8	2 ICLK
0008 71B8h	ICU	DTC activation enable register 184	DTCER184	8	8	2 ICLK
0008 71BAh	ICU	DTC activation enable register 186	DTCER186	8	8	2 ICLK
0008 71BBh	ICU	DTC activation enable register 187	DTCER187	8	8	2 ICLK
0008 71BCh	ICU	DTC activation enable register 188	DTCER188	8	8	2 ICLK
0008 71BDh	ICU	DTC activation enable register 189	DTCER189	8	8	2 ICLK

**Table 4.1 List of I/O Registers (Address Order) (6 / 25)**

Address	Module Abbreviation	Register Name	Register Abbreviation	Number of Bits	Access Size	Number of Access Cycles
0008 71BEh	ICU	DTC activation enable register 190	DTCER190	8	8	2 ICLK
0008 71C0h	ICU	DTC activation enable register 192	DTCER192	8	8	2 ICLK
0008 71C1h	ICU	DTC activation enable register 193	DTCER193	8	8	2 ICLK
0008 71C2h	ICU	DTC activation enable register 194	DTCER194	8	8	2 ICLK
0008 71C3h	ICU	DTC activation enable register 195	DTCER195	8	8	2 ICLK
0008 71C4h	ICU	DTC activation enable register 196	DTCER196	8	8	2 ICLK
0008 71D7h	ICU	DTC activation enable register 215	DTCER215	8	8	2 ICLK
0008 71D8h	ICU	DTC activation enable register 216	DTCER216	8	8	2 ICLK
0008 71DBh	ICU	DTC activation enable register 219	DTCER219	8	8	2 ICLK
0008 71DCh	ICU	DTC activation enable register 220	DTCER220	8	8	2 ICLK
0008 71DFh	ICU	DTC activation enable register 223	DTCER223	8	8	2 ICLK
0008 71E0h	ICU	DTC activation enable register 224	DTCER224	8	8	2 ICLK
0008 71F7h	ICU	DTC activation enable register 247	DTCER247	8	8	2 ICLK
0008 71F8h	ICU	DTC activation enable register 248	DTCER248	8	8	2 ICLK
0008 71FEh	ICU	DTC activation enable register 254	DTCER254	8	8	2 ICLK
0008 7202h	ICU	Interrupt request enable register 02	IER02	8	8	2 ICLK
0008 7203h	ICU	Interrupt request enable register 03	IER03	8	8	2 ICLK
0008 7205h	ICU	Interrupt request enable register 05	IER05	8	8	2 ICLK
0008 7207h	ICU	Interrupt request enable register 07	IER07	8	8	2 ICLK
0008 7208h	ICU	Interrupt request enable register 08	IER08	8	8	2 ICLK
0008 720Ch	ICU	Interrupt request enable register 0C	IER0C	8	8	2 ICLK
0008 720Dh	ICU	Interrupt request enable register 0D	IER0D	8	8	2 ICLK
0008 720Eh	ICU	Interrupt request enable register 0E	IER0E	8	8	2 ICLK
0008 720Fh	ICU	Interrupt request enable register 0F	IER0F	8	8	2 ICLK
0008 7210h	ICU	Interrupt request enable register 10	IER10	8	8	2 ICLK
0008 7211h	ICU	Interrupt request enable register 11	IER11	8	8	2 ICLK
0008 7212h	ICU	Interrupt request enable register 12	IER12	8	8	2 ICLK
0008 7213h	ICU	Interrupt request enable register 13	IER13	8	8	2 ICLK
0008 7215h	ICU	Interrupt request enable register 15	IER15	8	8	2 ICLK
0008 7216h	ICU	Interrupt request enable register 16	IER16	8	8	2 ICLK
0008 7217h	ICU	Interrupt request enable register 17	IER17	8	8	2 ICLK
0008 7218h	ICU	Interrupt request enable register 18	IER18	8	8	2 ICLK
0008 721Ah	ICU	Interrupt request enable register 1A	IER1A	8	8	2 ICLK
0008 721Bh	ICU	Interrupt request enable register 1B	IER1B	8	8	2 ICLK
0008 721Ch	ICU	Interrupt request enable register 1C	IER1C	8	8	2 ICLK
0008 721Eh	ICU	Interrupt request enable register 1E	IER1E	8	8	2 ICLK
0008 721Fh	ICU	Interrupt request enable register 1F	IER1F	8	8	2 ICLK
0008 72E0h	ICU	Software interrupt activation register	SWINTR	8	8	2 ICLK
0008 72F0h	ICU	Fast interrupt set register	FIR	16	16	2 ICLK
0008 7300h	ICU	Interrupt source priority register 00	IPR00	8	8	2 ICLK
0008 7301h	ICU	Interrupt source priority register 01	IPR01	8	8	2 ICLK
0008 7302h	ICU	Interrupt source priority register 02	IPR02	8	8	2 ICLK
0008 7303h	ICU	Interrupt source priority register 03	IPR03	8	8	2 ICLK
0008 7304h	ICU	Interrupt source priority register 04	IPR04	8	8	2 ICLK



**Table 4.1 List of I/O Registers (Address Order) (7 / 25)**

Address	Module Abbreviation	Register Name	Register Abbreviation	Number of Bits	Access Size	Number of Access Cycles
0008 7305h	ICU	Interrupt source priority register 05	IPR05	8	8	2 ICLK
0008 7306h	ICU	Interrupt source priority register 06	IPR06	8	8	2 ICLK
0008 7307h	ICU	Interrupt source priority register 07	IPR07	8	8	2 ICLK
0008 7314h	ICU	Interrupt source priority register 14	IPR14	8	8	2 ICLK
0008 7318h	ICU	Interrupt source priority register 18	IPR18	8	8	2 ICLK
0008 7320h	ICU	Interrupt source priority register 20	IPR20	8	8	2 ICLK
0008 7321h	ICU	Interrupt source priority register 21	IPR21	8	8	2 ICLK
0008 7322h	ICU	Interrupt source priority register 22	IPR22	8	8	2 ICLK
0008 7323h	ICU	Interrupt source priority register 23	IPR23	8	8	2 ICLK
0008 7324h	ICU	Interrupt source priority register 24	IPR24	8	8	2 ICLK
0008 7325h	ICU	Interrupt source priority register 25	IPR25	8	8	2 ICLK
0008 7326h	ICU	Interrupt source priority register 26	IPR26	8	8	2 ICLK
0008 7327h	ICU	Interrupt source priority register 27	IPR27	8	8	2 ICLK
0008 7340h	ICU	Interrupt source priority register 40	IPR40	8	8	2 ICLK
0008 7344h	ICU	Interrupt source priority register 44	IPR44	8	8	2 ICLK
0008 7348h	ICU	Interrupt source priority register 48	IPR48	8	8	2 ICLK
0008 7349h	ICU	Interrupt source priority register 49	IPR49	8	8	2 ICLK
0008 7351h	ICU	Interrupt source priority register 51	IPR51	8	8	2 ICLK
0008 7352h	ICU	Interrupt source priority register 52	IPR52	8	8	2 ICLK
0008 7353h	ICU	Interrupt source priority register 53	IPR53	8	8	2 ICLK
0008 7354h	ICU	Interrupt source priority register 54	IPR54	8	8	2 ICLK
0008 7355h	ICU	Interrupt source priority register 55	IPR55	8	8	2 ICLK
0008 7356h	ICU	Interrupt source priority register 56	IPR56	8	8	2 ICLK
0008 7357h	ICU	Interrupt source priority register 57	IPR57	8	8	2 ICLK
0008 7358h	ICU	Interrupt source priority register 58	IPR58	8	8	2 ICLK
0008 7359h	ICU	Interrupt source priority register 59	IPR59	8	8	2 ICLK
0008 735Ah	ICU	Interrupt source priority register 5A	IPR5A	8	8	2 ICLK
0008 735Bh	ICU	Interrupt source priority register 5B	IPR5B	8	8	2 ICLK
0008 735Ch	ICU	Interrupt source priority register 5C	IPR5C	8	8	2 ICLK
0008 735Dh	ICU	Interrupt source priority register 5D	IPR5D	8	8	2 ICLK
0008 735Eh	ICU	Interrupt source priority register 5E	IPR5E	8	8	2 ICLK
0008 735Fh	ICU	Interrupt source priority register 5F	IPR5F	8	8	2 ICLK
0008 7360h	ICU	Interrupt source priority register 60	IPR60	8	8	2 ICLK
0008 7367h	ICU	Interrupt source priority register 67	IPR67	8	8	2 ICLK
0008 7368h	ICU	Interrupt source priority register 68	IPR68	8	8	2 ICLK
0008 7369h	ICU	Interrupt source priority register 69	IPR69	8	8	2 ICLK
0008 736Ah	ICU	Interrupt source priority register 6A	IPR6A	8	8	2 ICLK
0008 736Bh	ICU	Interrupt source priority register 6B	IPR6B	8	8	2 ICLK
0008 736Ch	ICU	Interrupt source priority register 6C	IPR6C	8	8	2 ICLK
0008 736Dh	ICU	Interrupt source priority register 6D	IPR6D	8	8	2 ICLK
0008 736Eh	ICU	Interrupt source priority register 6E	IPR6E	8	8	2 ICLK
0008 736Fh	ICU	Interrupt source priority register 6F	IPR6F	8	8	2 ICLK
0008 7380h	ICU	Interrupt source priority register 80	IPR80	8	8	2 ICLK
0008 7381h	ICU	Interrupt source priority register 81	IPR81	8	8	2 ICLK

**Table 4.1 List of I/O Registers (Address Order) (8 / 25)**

Address	Module Abbreviation	Register Name	Register Abbreviation	Number of Bits	Access Size	Number of Access Cycles
0008 7382h	ICU	Interrupt source priority register 82	IPR82	8	8	2 ICLK
0008 7388h	ICU	Interrupt source priority register 88	IPR88	8	8	2 ICLK
0008 7389h	ICU	Interrupt source priority register 89	IPR89	8	8	2 ICLK
0008 738Ah	ICU	Interrupt source priority register 8A	IPR8A	8	8	2 ICLK
0008 738Bh	ICU	Interrupt source priority register 8B	IPR8B	8	8	2 ICLK
0008 7390h	ICU	Interrupt source priority register 90	IPR90	8	8	2 ICLK
0008 7500h	ICU	IRQ control register 0	IRQCR0	8	8	2 ICLK
0008 7501h	ICU	IRQ control register 1	IRQCR1	8	8	2 ICLK
0008 7502h	ICU	IRQ control register 2	IRQCR2	8	8	2 ICLK
0008 7503h	ICU	IRQ control register 3	IRQCR3	8	8	2 ICLK
0008 7504h	ICU	IRQ control register 4	IRQCR4	8	8	2 ICLK
0008 7505h	ICU	IRQ control register 5	IRQCR5	8	8	2 ICLK
0008 7506h	ICU	IRQ control register 6	IRQCR6	8	8	2 ICLK
0008 7507h	ICU	IRQ control register 7	IRQCR7	8	8	2 ICLK
0008 7580h	ICU	Non-maskable interrupt status register	NMISR	8	8	2 ICLK
0008 7581h	ICU	Non-maskable interrupt enable register	NMIER	8	8	2 ICLK
0008 7582h	ICU	Non-maskable interrupt clear register	NMICLR	8	8	2 ICLK
0008 7583h	ICU	NMI pin interrupt control register	NMICR	8	8	2 ICLK
0008 8000h	CMT	Compare match timer start register 0	CMSTR0	16	16	2, 3 PCLK*3
0008 8002h	CMT0	Compare match timer control register	CMCR	16	16	2, 3 PCLK*3
0008 8004h	CMT0	Compare match timer counter	CMCNT	16	16	2, 3 PCLK*3
0008 8006h	CMT0	Compare match timer constant register	CMCOR	16	16	2, 3 PCLK*3
0008 8008h	CMT1	Compare match timer control register	CMCR	16	16	2, 3 PCLK*3
0008 800Ah	CMT1	Compare match timer counter	CMCNT	16	16	2, 3 PCLK*3
0008 800Ch	CMT1	Compare match timer constant register	CMCOR	16	16	2, 3 PCLK*3
0008 8010h	CMT	Compare match timer start register 1	CMSTR1	16	16	2, 3 PCLK*3
0008 8012h	CMT2	Compare match timer control register	CMCR	16	16	2, 3 PCLK*3
0008 8014h	CMT2	Compare match timer counter	CMCNT	16	16	2, 3 PCLK*3
0008 8016h	CMT2	Compare match timer constant register	CMCOR	16	16	2, 3 PCLK*3
0008 8018h	CMT3	Compare match timer control register	CMCR	16	16	2, 3 PCLK*3
0008 801Ah	CMT3	Compare match timer counter	CMCNT	16	16	2, 3 PCLK*3
0008 801Ch	CMT3	Compare match timer constant register	CMCOR	16	16	2, 3 PCLK*3
0008 8028h	WDT	Timer control/status register	TCSR	8	8	2, 3 PCLK*3
0008 8028h	WDT	Write window A register	WINA	16	16	2, 3 PCLK*3
0008 8029h	WDT	Timer counter	TCNT	8	8	2, 3 PCLK*3
0008 802Ah	WDT	Write window B register	WINB	16	16	2, 3 PCLK*3
0008 802Bh	WDT	Reset control/status register	RSTCSR	8	8	2, 3 PCLK*3
0008 8030h	IWDT	IWDT refresh register	IWDTRR	8	8	2, 3 PCLK*3
0008 8032h	IWDT	IWDT control register	IWDTCR	16	16	2, 3 PCLK*3
0008 8034h	IWDT	IWDT status register	IWDTSR	16	16	2, 3 PCLK*3
0008 8040h	ADA	A/D data register A	ADDRA	16	16	2, 3 PCLK*3
0008 8042h	ADA	A/D data register B	ADDRB	16	16	2, 3 PCLK*3
0008 8044h	ADA	A/D data register C	ADDRC	16	16	2, 3 PCLK*3
0008 8046h	ADA	A/D data register D	ADDRD	16	16	2, 3 PCLK*3

**Table 4.1 List of I/O Registers (Address Order) (9 / 25)**

Address	Module Abbreviation	Register Name	Register Abbreviation	Number of Bits	Access Size	Number of Access Cycles
0008 8048h	ADA	A/D data register E	ADDRE	16	16	2, 3 PCLK*3
0008 804Ah	ADA	A/D data register F	ADDRF	16	16	2, 3 PCLK*3
0008 804Ch	ADA	A/D data register G	ADDRG	16	16	2, 3 PCLK*3
0008 804Eh	ADA	A/D data register H	ADDRH	16	16	2, 3 PCLK*3
0008 8050h	ADA	A/D control/status register	ADCSR	8	8	2, 3 PCLK*3
0008 8051h	ADA	A/D control register	ADCR	8	8	2, 3 PCLK*3
0008 805Bh	ADA	A/D sampling state register	ADSSTR	8	8	2, 3 PCLK*3
0008 805Dh	ADA	A/D self-diagnostic register	ADDIAGR	8	8	2, 3 PCLK*3
0008 8060h	ADA	A/D data register I	ADDRI	16	16	2, 3 PCLK*3
0008 8062h	ADA	A/D data register J	ADDRJ	16	16	2, 3 PCLK*3
0008 8064h	ADA	A/D data register K	ADDRK	16	16	2, 3 PCLK*3
0008 8066h	ADA	A/D data register L	ADDRL	16	16	2, 3 PCLK*3
0008 8070h	ADA	A/D start trigger select register	ADSTRGR	8	8	2, 3 PCLK*3
0008 8072h	ADA	A/D data placement register	ADDP	8	8	2, 3 PCLK*3
0008 8240h	SCI0	Serial mode register	SMR*1	8	8	2, 3 PCLK*3
0008 8241h	SCI0	Bit rate register	BRR	8	8	2, 3 PCLK*3
0008 8242h	SCI0	Serial control register	SCR*1	8	8	2, 3 PCLK*3
0008 8243h	SCI0	Transmit data register	TDR	8	8	2, 3 PCLK*3
0008 8244h	SCI0	Serial status register	SSR*1	8	8	2, 3 PCLK*3
0008 8245h	SCI0	Receive data register	RDR	8	8	2, 3 PCLK*3
0008 8246h	SCI0	Smart card mode register	SCMR	8	8	2, 3 PCLK*3
0008 8247h	SCI0	Serial extended mode register	SEMR	8	8	2, 3 PCLK*3
0008 8240h	SMCI0	Serial mode register	SMR	8	8	2, 3 PCLK*3
0008 8241h	SMCI0	Bit rate register	BRR	8	8	2, 3 PCLK*3
0008 8242h	SMCI0	Serial control register	SCR	8	8	2, 3 PCLK*3
0008 8243h	SMCI0	Transmit data register	TDR	8	8	2, 3 PCLK*3
0008 8244h	SMCI0	Serial status register	SSR	8	8	2, 3 PCLK*3
0008 8245h	SMCI0	Receive data register	RDR	8	8	2, 3 PCLK*3
0008 8246h	SMCI0	Smart card mode register	SCMR	8	8	2, 3 PCLK*3
0008 8248h	SCI1	Serial mode register	SMR*1	8	8	2, 3 PCLK*3
0008 8249h	SCI1	Bit rate register	BRR	8	8	2, 3 PCLK*3
0008 824Ah	SCI1	Serial control register	SCR*1	8	8	2, 3 PCLK*3
0008 824Bh	SCI1	Transmit data register	TDR	8	8	2, 3 PCLK*3
0008 824Ch	SCI1	Serial status register	SSR*1	8	8	2, 3 PCLK*3
0008 824Dh	SCI1	Receive data register	RDR	8	8	2, 3 PCLK*3
0008 824Eh	SCI1	Smart card mode register	SCMR	8	8	2, 3 PCLK*3
0008 824Fh	SCI1	Serial extended mode register	SEMR	8	8	2, 3 PCLK*3
0008 8248h	SMCI1	Serial mode register	SMR	8	8	2, 3 PCLK*3
0008 8249h	SMCI1	Bit rate register	BRR	8	8	2, 3 PCLK*3
0008 824Ah	SMCI1	Serial control register	SCR	8	8	2, 3 PCLK*3
0008 824Bh	SMCI1	Transmit data register	TDR	8	8	2, 3 PCLK*3
0008 824Ch	SMCI1	Serial status register	SSR	8	8	2, 3 PCLK*3
0008 824Dh	SMCI1	Receive data register	RDR	8	8	2, 3 PCLK*3
0008 824Eh	SMCI1	Smart card mode register	SCMR	8	8	2, 3 PCLK*3

**Table 4.1 List of I/O Registers (Address Order) (10 / 25)**

Address	Module Abbreviation	Register Name	Register Abbreviation	Number of Bits	Access Size	Number of Access Cycles
0008 8250h	SCI2	Serial mode register	SMR <sup>*1</sup>	8	8	2, 3 PCLK <sup>*3</sup>
0008 8251h	SCI2	Bit rate register	BRR	8	8	2, 3 PCLK <sup>*3</sup>
0008 8252h	SCI2	Serial control register	SCR <sup>*1</sup>	8	8	2, 3 PCLK <sup>*3</sup>
0008 8253h	SCI2	Transmit data register	TDR	8	8	2, 3 PCLK <sup>*3</sup>
0008 8254h	SCI2	Serial status register	SSR <sup>*1</sup>	8	8	2, 3 PCLK <sup>*3</sup>
0008 8255h	SCI2	Receive data register	RDR	8	8	2, 3 PCLK <sup>*3</sup>
0008 8256h	SCI2	Smart card mode register	SCMR	8	8	2, 3 PCLK <sup>*3</sup>
0008 8257h	SCI2	Serial extended mode register	SEMR	8	8	2, 3 PCLK <sup>*3</sup>
0008 8250h	SMCI2	Serial mode register	SMR <sup>*1</sup>	8	8	2, 3 PCLK <sup>*3</sup>
0008 8251h	SMCI2	Bit rate register	BRR	8	8	2, 3 PCLK <sup>*3</sup>
0008 8252h	SMCI2	Serial control register	SCR <sup>*1</sup>	8	8	2, 3 PCLK <sup>*3</sup>
0008 8253h	SMCI2	Transmit data register	TDR	8	8	2, 3 PCLK <sup>*3</sup>
0008 8254h	SMCI2	Serial status register	SSR <sup>*1</sup>	8	8	2, 3 PCLK <sup>*3</sup>
0008 8255h	SMCI2	Receive data register	RDR	8	8	2, 3 PCLK <sup>*3</sup>
0008 8256h	SMCI2	Smart card mode register	SCMR	8	8	2, 3 PCLK <sup>*3</sup>
0008 8280h	CRC	CRC control register	CRCCR	8	8	2, 3 PCLK <sup>*3</sup>
0008 8281h	CRC	CRC data input register	CRCDIR	8	8	2, 3 PCLK <sup>*3</sup>
0008 8282h	CRC	CRC data output register	CRCDOR	16	16	2, 3 PCLK <sup>*3</sup>
0008 8300h	RIIC	I <sup>2</sup> C bus control register 1	ICCR1	8	8	2, 3 PCLK <sup>*3</sup>
0008 8301h	RIIC	I <sup>2</sup> C bus control register 2	ICCR2	8	8	2, 3 PCLK <sup>*3</sup>
0008 8302h	RIIC	I <sup>2</sup> C bus mode register 1	ICMR1	8	8	2, 3 PCLK <sup>*3</sup>
0008 8303h	RIIC	I <sup>2</sup> C bus mode register 2	ICMR2	8	8	2, 3 PCLK <sup>*3</sup>
0008 8304h	RIIC	I <sup>2</sup> C bus mode register 3	ICMR3	8	8	2, 3 PCLK <sup>*3</sup>
0008 8305h	RIIC	I <sup>2</sup> C bus function enable register	ICFER	8	8	2, 3 PCLK <sup>*3</sup>
0008 8306h	RIIC	I <sup>2</sup> C bus status enable register	ICSER	8	8	2, 3 PCLK <sup>*3</sup>
0008 8307h	RIIC	I <sup>2</sup> C bus interrupt enable register	ICIER	8	8	2, 3 PCLK <sup>*3</sup>
0008 8308h	RIIC	I <sup>2</sup> C bus status register 1	ICSR1	8	8	2, 3 PCLK <sup>*3</sup>
0008 8309h	RIIC	I <sup>2</sup> C bus status register 2	ICSR2	8	8	2, 3 PCLK <sup>*3</sup>
0008 830Ah	RIIC	Slave address register L0	SARL0	8	8	2, 3 PCLK <sup>*3</sup>
0008 830Ah	RIIC	Internal counter L for timeout	TMOCNTL	8	8	2, 3 PCLK <sup>*3</sup>
0008 830Bh	RIIC	Slave address register U0	SARU0	8	8	2, 3 PCLK <sup>*3</sup>
0008 830Bh	RIIC	Internal counter U for timeout	TMOCNTU	8	8	2, 3 PCLK <sup>*3</sup>
0008 830Bh	RIIC	Slave address register U0	SARU0	8	8	2, 3 PCLK <sup>*3</sup>
0008 830Ch	RIIC	Slave address register L1	SARL1	8	8	2, 3 PCLK <sup>*3</sup>
0008 830Dh	RIIC	Slave address register U1	SARU1	8	8	2, 3 PCLK <sup>*3</sup>
0008 830Eh	RIIC	Slave address register L2	SARL2	8	8	2, 3 PCLK <sup>*3</sup>
0008 830Fh	RIIC	Slave address register U2	SARU2	8	8	2, 3 PCLK <sup>*3</sup>
0008 8310h	RIIC	I <sup>2</sup> C bus bit rate low-level register	ICBRL	8	8	2, 3 PCLK <sup>*3</sup>
0008 8311h	RIIC	I <sup>2</sup> C bus bit rate high-level register	ICBRH	8	8	2, 3 PCLK <sup>*3</sup>
0008 8312h	RIIC	I <sup>2</sup> C bus transmit data register	ICDRT	8	8	2, 3 PCLK <sup>*3</sup>
0008 8313h	RIIC	I <sup>2</sup> C bus receive data register	ICDRR	8	8	2, 3 PCLK <sup>*3</sup>
0008 8380h	RSPI	RSPI control register	SPCR	8	8	2, 3 PCLK <sup>*3</sup>
0008 8381h	RSPI	RSPI slave select polarity register	SSLP	8	8	2, 3 PCLK <sup>*3</sup>
0008 8382h	RSPI	RSPI pin control register	SPPCR	8	8	2, 3 PCLK <sup>*3</sup>

**Table 4.1 List of I/O Registers (Address Order) (11 / 25)**

Address	Module Abbreviation	Register Name	Register Abbreviation	Number of Bits	Access Size	Number of Access Cycles
0008 8383h	RSPI	RSPI status register	SPSR	8	8	2, 3 PCLK*3
0008 8384h	RSPI	RSPI data register	SPDR	16, 32	16, 32	2, 3 PCLK*3
0008 8388h	RSPI	RSPI sequence control register	SPSCR	8	8	2, 3 PCLK*3
0008 8389h	RSPI	RSPI sequence status register	SPSSR	8	8	2, 3 PCLK*3
0008 838Ah	RSPI	RSPI bit rate register	SPBR	8	8	2, 3 PCLK*3
0008 838Bh	RSPI	RSPI data control register	SPDCR	8	8	2, 3 PCLK*3
0008 838Ch	RSPI	RSPI clock delay register	SPCKD	8	8	2, 3 PCLK*3
0008 838Dh	RSPI	RSPI slave select negation delay register	SSLND	8	8	2, 3 PCLK*3
0008 838Eh	RSPI	RSPI next-access delay register	SPND	8	8	2, 3 PCLK*3
0008 838Fh	RSPI	RSPI control register 2	SPCR2	8	8	2, 3 PCLK*3
0008 8390h	RSPI	RSPI command register 0	SPCMD0	16	16	2, 3 PCLK*3
0008 8392h	RSPI	RSPI command register 1	SPCMD1	16	16	2, 3 PCLK*3
0008 8394h	RSPI	RSPI command register 2	SPCMD2	16	16	2, 3 PCLK*3
0008 8396h	RSPI	RSPI command register 3	SPCMD3	16	16	2, 3 PCLK*3
0008 8398h	RSPI	RSPI command register 4	SPCMD4	16	16	2, 3 PCLK*3
0008 839Ah	RSPI	RSPI command register 5	SPCMD5	16	16	2, 3 PCLK*3
0008 839Ch	RSPI	RSPI command register 6	SPCMD6	16	16	2, 3 PCLK*3
0008 839Eh	RSPI	RSPI command register 7	SPCMD7	16	16	2, 3 PCLK*3
0008 9000h	S12AD0	A/D control register	ADCSR	8	8	2, 3 PCLK*3
0008 9004h	S12AD0	A/D channel select register	ADANS	16	16	2, 3 PCLK*3
0008 900Ah	S12AD0	A/D programmable gain amplifier register	ADPG	16	16	2, 3 PCLK*3
0008 900Eh	S12AD0	A/D control extended register	ADCER	16	16	2, 3 PCLK*3
0008 9010h	S12AD0	A/D start trigger select register	ADSTRGR	16	16	2, 3 PCLK*3
0008 9012h	S12AD	Comparator operating mode select register 0	ADCMPO0	16	16	2, 3 PCLK*3
0008 9014h	S12AD	Comparator operating mode select register 1	ADCMPO1	16	16	2, 3 PCLK*3
0008 9016h	S12AD	Comparator filter mode register 0	ADCMFNR0	16	16	2, 3 PCLK*3
0008 9018h	S12AD	Comparator filter mode register 1	ADCMFNR1	16	16	2, 3 PCLK*3
0008 901Ah	S12AD	Comparator detection flag register	ADCMFDR	8	8	2, 3 PCLK*3
0008 901Ch	S12AD	Comparator interrupt select register	ADCMISEL	16	16	2, 3 PCLK*3
0008 901Eh	S12AD0	A/D data register Diag	ADRD	16	16	2, 3 PCLK*3
0008 9020h	S12AD0	A/D data register 0A	ADDR0A	16	16	2, 3 PCLK*3
0008 9022h	S12AD0	A/D data register 1	ADDR1	16	16	2, 3 PCLK*3
0008 9024h	S12AD0	A/D data register 2	ADDR2	16	16	2, 3 PCLK*3
0008 9026h	S12AD0	A/D data register 3	ADDR3	16	16	2, 3 PCLK*3
0008 9030h	S12AD0	A/D data register 0B	ADDR0B	16	16	2, 3 PCLK*3
0008 9060h	S12AD0	A/D sampling state register	ADSSTR	8	8	2, 3 PCLK*3
0008 9080h	S12AD1	A/D control register	ADCSR	8	8	2, 3 PCLK*3
0008 9084h	S12AD1	A/D channel select register	ADANS	16	16	2, 3 PCLK*3
0008 908Ah	S12AD1	A/D programmable gain amplifier register	ADPG	16	16	2, 3 PCLK*3
0008 908Eh	S12AD1	A/D control extended register	ADCER	16	16	2, 3 PCLK*3
0008 9090h	S12AD1	A/D start trigger select register	ADSTRGR	16	16	2, 3 PCLK*3
0008 909Eh	S12AD1	A/D data register Diag	ADRD	16	16	2, 3 PCLK*3
0008 90A0h	S12AD1	A/D data register 0A	ADDR0A	16	16	2, 3 PCLK*3
0008 90A2h	S12AD1	A/D data register 1	ADDR1	16	16	2, 3 PCLK*3

**Table 4.1 List of I/O Registers (Address Order) (12 / 25)**

Address	Module Abbreviation	Register Name	Register Abbreviation	Number of Bits	Access Size	Number of Access Cycles
0008 90A4h	S12AD1	A/D data register 2	ADDR2	16	16	2, 3 PCLK*3
0008 90A6h	S12AD1	A/D data register 3	ADDR3	16	16	2, 3 PCLK*3
0008 90B0h	S12AD1	A/D data register 0B	ADDR0B	16	16	2, 3 PCLK*3
0008 90E0h	S12AD1	A/D sampling state register	ADSSTR	8	8	2, 3 PCLK*3
0008 C001h	PORT1	Data direction register	DDR	8	8	2, 3 PCLK*3
0008 C002h	PORT2	Data direction register	DDR	8	8	2, 3 PCLK*3
0008 C003h	PORT3	Data direction register	DDR	8	8	2, 3 PCLK*3
0008 C007h	PORT7	Data direction register	DDR	8	8	2, 3 PCLK*3
0008 C008h	PORT8	Data direction register	DDR	8	8	2, 3 PCLK*3
0008 C009h	PORT9	Data direction register	DDR	8	8	2, 3 PCLK*3
0008 C00Ah	PORTA	Data direction register	DDR	8	8	2, 3 PCLK*3
0008 C00Bh	PORTB	Data direction register	DDR	8	8	2, 3 PCLK*3
0008 C00Dh	PORTD	Data direction register	DDR	8	8	2, 3 PCLK*3
0008 C00Eh	PORTE	Data direction register	DDR	8	8	2, 3 PCLK*3
0008 C010h	PORTG	Data direction register	DDR*1	8	8	2, 3 PCLK*3
0008 C021h	PORT1	Data register	DR	8	8	2, 3 PCLK*3
0008 C022h	PORT2	Data register	DR	8	8	2, 3 PCLK*3
0008 C023h	PORT3	Data register	DR	8	8	2, 3 PCLK*3
0008 C027h	PORT7	Data register	DR	8	8	2, 3 PCLK*3
0008 C028h	PORT8	Data register	DR	8	8	2, 3 PCLK*3
0008 C029h	PORT9	Data register	DR	8	8	2, 3 PCLK*3
0008 C02Ah	PORTA	Data register	DR	8	8	2, 3 PCLK*3
0008 C02Bh	PORTB	Data register	DR	8	8	2, 3 PCLK*3
0008 C02Dh	PORTD	Data register	DR	8	8	2, 3 PCLK*3
0008 C02Eh	PORTE	Data register	DR	8	8	2, 3 PCLK*3
0008 C030h	PORTG	Data register	DR*1	8	8	2, 3 PCLK*3
0008 C041h	PORT1	Data register	PORT	8	8	2, 3 PCLK*3
0008 C042h	PORT2	Data register	PORT	8	8	2, 3 PCLK*3
0008 C043h	PORT3	Data register	PORT	8	8	2, 3 PCLK*3
0008 C044h	PORT4	Data register	PORT	8	8	2, 3 PCLK*3
0008 C045h	PORT5	Data register	PORT	8	8	2, 3 PCLK*3
0008 C046h	PORT6	Data register	PORT	8	8	2, 3 PCLK*3
0008 C047h	PORT7	Data register	PORT	8	8	2, 3 PCLK*3
0008 C048h	PORT8	Data register	PORT	8	8	2, 3 PCLK*3
0008 C049h	PORT9	Data register	PORT	8	8	2, 3 PCLK*3
0008 C04Ah	PORTA	Data register	PORT	8	8	2, 3 PCLK*3
0008 C04Bh	PORTB	Data register	PORT	8	8	2, 3 PCLK*3
0008 C04Dh	PORTD	Data register	PORT	8	8	2, 3 PCLK*3
0008 C04Eh	PORTE	Data register	PORT	8	8	2, 3 PCLK*3
0008 C050h	PORTG	Port register	PORT*1	8	8	2, 3 PCLK*3
0008 C061h	PORT1	Input buffer control register	ICR	8	8	2, 3 PCLK*3
0008 C062h	PORT2	Input buffer control register	ICR	8	8	2, 3 PCLK*3
0008 C063h	PORT3	Input buffer control register	ICR	8	8	2, 3 PCLK*3
0008 C064h	PORT4	Input buffer control register	ICR	8	8	2, 3 PCLK*3

**Table 4.1 List of I/O Registers (Address Order) (13 / 25)**

Address	Module Abbreviation	Register Name	Register Abbreviation	Number of Bits	Access Size	Number of Access Cycles
0008 C065h	PORT5	Input buffer control register	ICR	8	8	2, 3 PCLK*3
0008 C066h	PORT6	Input buffer control register	ICR	8	8	2, 3 PCLK*3
0008 C067h	PORT7	Input buffer control register	ICR	8	8	2, 3 PCLK*3
0008 C068h	PORT8	Input buffer control register	ICR	8	8	2, 3 PCLK*3
0008 C069h	PORT9	Input buffer control register	ICR	8	8	2, 3 PCLK*3
0008 C06Ah	PORTA	Input buffer control register	ICR	8	8	2, 3 PCLK*3
0008 C06Bh	PORTB	Input buffer control register	ICR	8	8	2, 3 PCLK*3
0008 C06Dh	PORTD	Input buffer control register	ICR	8	8	2, 3 PCLK*3
0008 C06Eh	PORTE	Input buffer control register	ICR	8	8	2, 3 PCLK*3
0008 C070h	PORTG	Input buffer control register	ICR*1	8	8	2, 3 PCLK*3
0008 C108h	IOPORT	Port function register 8	PF8IRQ	8	8	2, 3 PCLK*3
0008 C109h	IOPORT	Port function register 9	PF9IRQ	8	8	2, 3 PCLK*3
0008 C10Ah	IOPORT	Port function register A	PFAADC	8	8	2, 3 PCLK*3
0008 C10Ch	IOPORT	Port function register C	PFCMTU	8	8	2, 3 PCLK*3
0008 C10Dh	IOPORT	Port function register D	PFDGPT	8	8	2, 3 PCLK*3
0008 C10Fh	IOPORT	Port function register F	PFFSCI	8	8	2, 3 PCLK*3
0008 C110h	IOPORT	Port function register G	PFGSPI	8	8	2, 3 PCLK*3
0008 C111h	IOPORT	Port function register H	PFHSPI	8	8	2, 3 PCLK*3
0008 C113h	IOPORT	Port function register J	PFJCAN	8	8	2, 3 PCLK*3
0008 C114h	IOPORT	Port function register K	PFKLIN	8	8	2, 3 PCLK*3
0008 C116h	IOPORT	Port function register M	PFMPOE	8	8	2, 3 PCLK*3
0008 C117h	IOPORT	Port function register N	PFNPOE	8	8	2, 3 PCLK*3
0008 C280h	SYSTEM	Deep standby control register	DPSBYCR	8	8	4, 5 PCLK*3
0008 C281h	SYSTEM	Deep standby wait control register	DPSWCR	8	8	4, 5 PCLK*3
0008 C282h	SYSTEM	Deep standby interrupt enable register	DPSIER	8	8	4, 5 PCLK*3
0008 C283h	SYSTEM	Deep standby interrupt flag register	DPSIFR	8	8	4, 5 PCLK*3
0008 C284h	SYSTEM	Deep standby interrupt edge register	DPSIEGR	8	8	4, 5 PCLK*3
0008 C285h	SYSTEM	Reset status register	RSTSR	8	8	4, 5 PCLK*3
0008 C289h	FLASH	Flash write erase protection register	FWEPOR	8	8	4, 5 PCLK*3
0008 C28Ch	SYSTEM	Key code register for low-voltage detection control register	LVDKEYR	8	8	4, 5 PCLK*3
0008 C28Dh	SYSTEM	Voltage detection control register	LVDCR	8	8	4, 5 PCLK*3
0008 C290h	SYSTEM	Deep standby backup register 0	DPSBKR0	8	8	4, 5 PCLK*3
0008 C291h	SYSTEM	Deep standby backup register 1	DPSBKR1	8	8	4, 5 PCLK*3
0008 C292h	SYSTEM	Deep standby backup register 2	DPSBKR2	8	8	4, 5 PCLK*3
0008 C293h	SYSTEM	Deep standby backup register 3	DPSBKR3	8	8	4, 5 PCLK*3
0008 C294h	SYSTEM	Deep standby backup register 4	DPSBKR4	8	8	4, 5 PCLK*3
0008 C295h	SYSTEM	Deep standby backup register 5	DPSBKR5	8	8	4, 5 PCLK*3
0008 C296h	SYSTEM	Deep standby backup register 6	DPSBKR6	8	8	4, 5 PCLK*3
0008 C297h	SYSTEM	Deep standby backup register 7	DPSBKR7	8	8	4, 5 PCLK*3
0008 C298h	SYSTEM	Deep standby backup register 8	DPSBKR8	8	8	4, 5 PCLK*3
0008 C299h	SYSTEM	Deep standby backup register 9	DPSBKR9	8	8	4, 5 PCLK*3
0008 C29Ah	SYSTEM	Deep standby backup register 10	DPSBKR10	8	8	4, 5 PCLK*3
0008 C29Bh	SYSTEM	Deep standby backup register 11	DPSBKR11	8	8	4, 5 PCLK*3

**Table 4.1 List of I/O Registers (Address Order) (14 / 25)**

Address	Module Abbreviation	Register Name	Register Abbreviation	Number of Bits	Access Size	Number of Access Cycles
0008 C29Ch	SYSTEM	Deep standby backup register 12	DPSBKR12	8	8	4, 5 PCLK*3
0008 C29Dh	SYSTEM	Deep standby backup register 13	DPSBKR13	8	8	4, 5 PCLK*3
0008 C29Eh	SYSTEM	Deep standby backup register 14	DPSBKR14	8	8	4, 5 PCLK*3
0008 C29Fh	SYSTEM	Deep standby backup register 15	DPSBKR15	8	8	4, 5 PCLK*3
0008 C2A0h	SYSTEM	Deep standby backup register 16	DPSBKR16	8	8	4, 5 PCLK*3
0008 C2A1h	SYSTEM	Deep standby backup register 17	DPSBKR17	8	8	4, 5 PCLK*3
0008 C2A2h	SYSTEM	Deep standby backup register 18	DPSBKR18	8	8	4, 5 PCLK*3
0008 C2A3h	SYSTEM	Deep standby backup register 19	DPSBKR19	8	8	4, 5 PCLK*3
0008 C2A4h	SYSTEM	Deep standby backup register 20	DPSBKR20	8	8	4, 5 PCLK*3
0008 C2A5h	SYSTEM	Deep standby backup register 21	DPSBKR21	8	8	4, 5 PCLK*3
0008 C2A6h	SYSTEM	Deep standby backup register 22	DPSBKR22	8	8	4, 5 PCLK*3
0008 C2A7h	SYSTEM	Deep standby backup register 23	DPSBKR23	8	8	4, 5 PCLK*3
0008 C2A8h	SYSTEM	Deep standby backup register 24	DPSBKR24	8	8	4, 5 PCLK*3
0008 C2A9h	SYSTEM	Deep standby backup register 25	DPSBKR25	8	8	4, 5 PCLK*3
0008 C2AAh	SYSTEM	Deep standby backup register 26	DPSBKR26	8	8	4, 5 PCLK*3
0008 C2ABh	SYSTEM	Deep standby backup register 27	DPSBKR27	8	8	4, 5 PCLK*3
0008 C2ACh	SYSTEM	Deep standby backup register 28	DPSBKR28	8	8	4, 5 PCLK*3
0008 C2ADh	SYSTEM	Deep standby backup register 29	DPSBKR29	8	8	4, 5 PCLK*3
0008 C2AEh	SYSTEM	Deep standby backup register 30	DPSBKR30	8	8	4, 5 PCLK*3
0008 C2AFh	SYSTEM	Deep standby backup register 31	DPSBKR31	8	8	4, 5 PCLK*3
0008 C4C0h	POE	Input level control/status register 1	ICSR1	16	8, 16	2, 3 PCLK*3
0008 C4C2h	POE	Output level control/status register 1	OCSR1	16	8, 16	2, 3 PCLK*3
0008 C4C4h	POE	Input level control/status register 2	ICSR2	16	8, 16	2, 3 PCLK*3
0008 C4C6h	POE	Output level control/status register 2	OCSR2	16	8, 16	2, 3 PCLK*3
0008 C4C8h	POE	Input level control/status register 3	ICSR3	16	8, 16	2, 3 PCLK*3
0008 C4CAh	POE	Software port output enable register	SPOER	8	8	2, 3 PCLK*3
0008 C4CBh	POE	Port output enable control register 1	POECR1	8	8	2, 3 PCLK*3
0008 C4CCh	POE	Port output enable control register 2	POECR2	16	16	2, 3 PCLK*3
0008 C4CEh	POE	Port output enable control register 3	POECR3	16	16	2, 3 PCLK*3
0008 C4D0h	POE	Port output enable control register 4	POECR4	16	16	2, 3 PCLK*3
0008 C4D2h	POE	Port output enable control register 5	POECR5	16	16	2, 3 PCLK*3
0008 C4D4h	POE	Port output enable control register 6	POECR6	16	16	2, 3 PCLK*3
0008 C4D6h	POE	Input level control/status register 4	ICSR4	16	8, 16	2, 3 PCLK*3
0008 C4D8h	POE	Input level control/status register 5	ICSR5	16	8, 16	2, 3 PCLK*3
0008 C4DAh	POE	Active level setting register 1	ALR1	16	8, 16	2, 3 PCLK*3
0009 0200h to 0009 03FFh	CAN0*2	Mailbox registers 0 to 31	MB0 to MB 31	128	8, 16, 32	2, 3 PCLK*3
0009 0400h	CAN0*2	Mask register 0	MKR0	32	8, 16, 32	2, 3 PCLK*3
0009 0404h	CAN0*2	Mask register 1	MKR1	32	8, 16, 32	2, 3 PCLK*3
0009 0408h	CAN0*2	Mask register 2	MKR2	32	8, 16, 32	2, 3 PCLK*3
0009 040Ch	CAN0*2	Mask register 3	MKR3	32	8, 16, 32	2, 3 PCLK*3
0009 0410h	CAN0*2	Mask register 4	MKR4	32	8, 16, 32	2, 3 PCLK*3
0009 0414h	CAN0*2	Mask register 5	MKR5	32	8, 16, 32	2, 3 PCLK*3
0009 0418h	CAN0*2	Mask register 6	MKR6	32	8, 16, 32	2, 3 PCLK*3



**Table 4.1 List of I/O Registers (Address Order) (15 / 25)**

Address	Module Abbreviation	Register Name	Register Abbreviation	Number of Bits	Access Size	Number of Access Cycles
0009 041Ch	CAN0*2	Mask register 7	MKR7	32	8, 16, 32	2, 3 PCLK*3
0009 0420h	CAN0*2	FIFO received ID compare register 0	FIDCR0	32	8, 16, 32	2, 3 PCLK*3
0009 0424h	CAN0*2	FIFO received ID compare register 1	FIDCR1	32	8, 16, 32	2, 3 PCLK*3
0009 0428h	CAN0*2	Mask invalid register	MKIVLR	32	8, 16, 32	2, 3 PCLK*3
0009 042Ch	CAN0*2	Mailbox interrupt enable register	MIER	32	8, 16, 32	2, 3 PCLK*3
0009 0820h to 0009 083Fh	CAN0*2	Message control registers 0 to 31	MCTL0 to MCTL31	8	8	2, 3 PCLK*3
0009 0840h	CAN0*2	Control register	CTLR	16	8, 16	2, 3 PCLK*3
0009 0842h	CAN0*2	Status register	STR	16	8, 16	2, 3 PCLK*3
0009 0844h	CAN0*2	Bit configuration register	BCR	32	8, 16, 32	2, 3 PCLK*3
0009 0848h	CAN0*2	Receive FIFO control register	RFCR	8	8	2, 3 PCLK*3
0009 0849h	CAN0*2	Receive FIFO pointer control register	RFPCR	8	8	2, 3 PCLK*3
0009 084Ah	CAN0*2	Transmit FIFO control register	TFCR	8	8	2, 3 PCLK*3
0009 084Bh	CAN0*2	Transmit FIFO pointer control register	TFPCR	8	8	2, 3 PCLK*3
0009 084Ch	CAN0*2	Error interrupt enable register	EIER	8	8	2, 3 PCLK*3
0009 084Dh	CAN0*2	Error interrupt factor judge register	EIFR	8	8	2, 3 PCLK*3
0009 084Eh	CAN0*2	Receive error count register	RECR	8	8	2, 3 PCLK*3
0009 084Fh	CAN0*2	Transmit error count register	TECR	8	8	2, 3 PCLK*3
0009 0850h	CAN0*2	Error code store register	ECSR	8	8	2, 3 PCLK*3
0009 0851h	CAN0*2	Channel search support register	CSSR	8	8	2, 3 PCLK*3
0009 0852h	CAN0*2	Mailbox search status register	MSSR	8	8	2, 3 PCLK*3
0009 0853h	CAN0*2	Mailbox search mode register	MSMR	8	8	2, 3 PCLK*3
0009 0854h	CAN0*2	Time stamp register	TSR	16	8, 16	2, 3 PCLK*3
0009 0856h	CAN0*2	Acceptance filter support register	AFSR	16	8, 16	2, 3 PCLK*3
0009 0858h	CAN0*2	Test control register	TCR	8	8	2, 3 PCLK*3
0009 4001h	LIN0	LIN wake-up baud rate select register	LWBR	8	8	2, 3 PCLK*3
0009 4002h	LIN0	LIN baud rate prescaler 0 register	LBRP0	8	8, 16	2, 3 PCLK*3
0009 4003h	LIN0	LIN baud rate prescaler 1 register	LBRP1	8	8, 16	2, 3 PCLK*3
0009 4004h	LIN0	LIN self-test control register	LSTC	8	8	2, 3 PCLK*3
0009 4008h	LIN0	Mode register	L0MD	8	8, 16, 32	2, 3 PCLK*3
0009 4009h	LIN0	Break field setting register	L0BRK	8	8, 16, 32	2, 3 PCLK*3
0009 400Ah	LIN0	Space setting register	L0SPC	8	8, 16, 32	2, 3 PCLK*3
0009 400Bh	LIN0	Wake-up setting register	L0WUP	8	8, 16, 32	2, 3 PCLK*3
0009 400Ch	LIN0	Interrupt enable register	L0IE	8	8, 16	2, 3 PCLK*3
0009 400Dh	LIN0	Error detection enable register	L0EDE	8	8, 16	2, 3 PCLK*3
0009 400Eh	LIN0	Control register	L0C	8	8	2, 3 PCLK*3
0009 4010h	LIN0	Transmission control register	L0TC	8	8, 16, 32	2, 3 PCLK*3
0009 4011h	LIN0	Mode status register	L0MST	8	8, 16, 32	2, 3 PCLK*3
0009 4012h	LIN0	Status register	L0ST	8	8, 16, 32	2, 3 PCLK*3
0009 4013h	LIN0	Error status register	L0EST	8	8, 16, 32	2, 3 PCLK*3
0009 4014h	LIN0	Response field set register	L0RFC	8	8, 16	2, 3 PCLK*3
0009 4015h	LIN0	Buffer register	L0IDB	8	8, 16	2, 3 PCLK*3
0009 4016h	LIN0	Check sum buffer register	L0CBR	8	8	2, 3 PCLK*3
0009 4018h	LIN0	Data 1 buffer register	L0DB1	8	8, 16, 32	2, 3 PCLK*3

**Table 4.1 List of I/O Registers (Address Order) (16 / 25)**

Address	Module Abbreviation	Register Name	Register Abbreviation	Number of Bits	Access Size	Number of Access Cycles
0009 4019h	LIN0	Data 2 buffer register	L0DB2	8	8, 16, 32	2, 3 PCLK* <sup>3</sup>
0009 401Ah	LIN0	Data 3 buffer register	L0DB3	8	8, 16, 32	2, 3 PCLK* <sup>3</sup>
0009 401Bh	LIN0	Data 4 buffer register	L0DB4	8	8, 16, 32	2, 3 PCLK* <sup>3</sup>
0009 401Ch	LIN0	Data 5 buffer register	L0DB5	8	8, 16, 32	2, 3 PCLK* <sup>3</sup>
0009 401Dh	LIN0	Data 6 buffer register	L0DB6	8	8, 16, 32	2, 3 PCLK* <sup>3</sup>
0009 401Eh	LIN0	Data 7 buffer register	L0DB7	8	8, 16, 32	2, 3 PCLK* <sup>3</sup>
0009 401Fh	LIN0	Data 8 buffer register	L0DB8	8	8, 16, 32	2, 3 PCLK* <sup>3</sup>
000C 1200h	MTU3	Timer control register	TCR	8	8, 16, 32	5 ICLK
000C 1201h	MTU4	Timer control register	TCR	8	8	5 ICLK
000C 1202h	MTU3	Timer mode register 1	TMDR1	8	8, 16	5 ICLK
000C 1203h	MTU4	Timer mode register 1	TMDR1	8	8	5 ICLK
000C 1204h	MTU3	Timer I/O control register H	TIORH	8	8, 16, 32	5 ICLK
000C 1205h	MTU3	Timer I/O control register L	TIORL	8	8	5 ICLK
000C 1206h	MTU4	Timer I/O control register H	TIORH	8	8, 16	5 ICLK
000C 1207h	MTU4	Timer I/O control register L	TIORL	8	8	5 ICLK
000C 1208h	MTU3	Timer interrupt enable register	TIER	8	8, 16	5 ICLK
000C 1209h	MTU4	Timer interrupt enable register	TIER	8	8	5 ICLK
000C 120Ah	MTU	Timer output master enable register A	TOERA	8	8	5 ICLK
000C 120Dh	MTU	Timer gate control register A	TGCRA	8	8	5 ICLK
000C 120Eh	MTU	Timer output control register 1A	TOCR1A	8	8, 16	5 ICLK
000C 120Fh	MTU	Timer output control register 2A	TOCR2A	8	8	5 ICLK
000C 1210h	MTU3	Timer counter	TCNT	16	16, 32	5 ICLK
000C 1212h	MTU4	Timer counter	TCNT	16	16	5 ICLK
000C 1214h	MTU	Timer cycle data register A	TCDRA	16	16, 32	5 ICLK
000C 1216h	MTU	Timer dead time data register A	TDDRA	16	16	5 ICLK
000C 1218h	MTU3	Timer general register A	TGRA	16	16, 32	5 ICLK
000C 121Ah	MTU3	Timer general register B	TGRB	16	16	5 ICLK
000C 121Ch	MTU4	Timer general register A	TGRA	16	16, 32	5 ICLK
000C 121Eh	MTU4	Timer general register B	TGRB	16	16	5 ICLK
000C 1220h	MTU	Timer subcounter A	TCNTSA	16	16, 32	5 ICLK
000C 1222h	MTU	Timer cycle buffer register A	TCBRA	16	16	5 ICLK
000C 1224h	MTU3	Timer general register C	TGRC	16	16, 32	5 ICLK
000C 1226h	MTU3	Timer general register D	TGRD	16	16	5 ICLK
000C 1228h	MTU4	Timer general register C	TGRC	16	16, 32	5 ICLK
000C 122Ah	MTU4	Timer general register D	TGRD	16	16	5 ICLK
000C 122Ch	MTU3	Timer status register	TSR	8	8, 16	5 ICLK
000C 122Dh	MTU4	Timer status register	TSR	8	8	5 ICLK
000C 1230h	MTU	Timer interrupt skipping set register 1A	TITCR1A	8	8, 16	5 ICLK
000C 1231h	MTU	Timer interrupt skipping counter 1A	TITCNT1A	8	8	5 ICLK
000C 1232h	MTU	Timer buffer transfer set register A	TBTERA	8	8	5 ICLK
000C 1234h	MTU	Timer dead time enable register A	TDERA	8	8	5 ICLK
000C 1236h	MTU	Timer output level buffer register A	TOLBRA	8	8	5 ICLK
000C 1238h	MTU3	Timer buffer operation transfer mode register	TBTM	8	8, 16	5 ICLK
000C 1239h	MTU4	Timer buffer operation transfer mode register	TBTM	8	8	5 ICLK

**Table 4.1 List of I/O Registers (Address Order) (17 / 25)**

Address	Module Abbreviation	Register Name	Register Abbreviation	Number of Bits	Access Size	Number of Access Cycles
000C 123Ah	MTU	Timer interrupt skipping mode register A	TITMRA	8	8	5 ICLK
000C 123Bh	MTU	Timer interrupt skipping set register 2A	TITCR2A	8	8	5 ICLK
000C 123Ch	MTU	Timer interrupt skipping counter 2A	TITCNT2A	8	8	5 ICLK
000C 1240h	MTU4	Timer A/D converter start request control register	TADCR	16	16	5 ICLK
000C 1244h	MTU4	Timer A/D converter start request cycle set register A	TADCORA	16	16, 32	5 ICLK
000C 1246h	MTU4	Timer A/D converter start request cycle set register B	TADCORB	16	16	5 ICLK
000C 1248h	MTU4	Timer A/D converter start request cycle set buffer register A	TADCOBRA	16	16, 32	5 ICLK
000C 124Ah	MTU4	Timer A/D converter start request cycle set buffer register B	TADCOBRB	16	16	5 ICLK
000C 1260h	MTU	Timer waveform control register A	TWCRA	8	8	5 ICLK
000C 1270h	MTU3	Timer mode register 2A	TMDR2A	8	8	5 ICLK
000C 1272h	MTU3	Timer general register E	TGRE	16	16	5 ICLK
000C 1274h	MTU4	Timer general register E	TGRE	16	16	5 ICLK
000C 1276h	MTU4	Timer general register F	TGRF	16	16	5 ICLK
000C 1280h	MTU	Timer start register A	TSTRA	8	8, 16	5 ICLK
000C 1281h	MTU	Timer synchronous register A	TSYRA	8	8	5 ICLK
000C 1282h	MTU	Timer counter synchronous start register	TCSYSTR	8	8	5 ICLK
000C 1284h	MTU	Timer read/write enable register A	TRWERA	8	8	5 ICLK
000C 1300h	MTU0	Timer control register	TCR	8	8, 16, 32	5 ICLK
000C 1301h	MTU0	Timer mode register 1	TMDR1	8	8	5 ICLK
000C 1302h	MTU0	Timer I/O control register H	TIORH	8	8, 16	5 ICLK
000C 1303h	MTU0	Timer I/O control register L	TIORL	8	8	5 ICLK
000C 1304h	MTU0	Timer interrupt enable register	TIER	8	8, 16, 32	5 ICLK
000C 1305h	MTU0	Timer status register	TSR	8	8	5 ICLK
000C 1306h	MTU0	Timer counter	TCNT	16	16	5 ICLK
000C 1308h	MTU0	Timer general register A	TGRA	16	16, 32	5 ICLK
000C 130Ah	MTU0	Timer general register B	TGRB	16	16	5 ICLK
000C 130Ch	MTU0	Timer general register C	TGRC	16	16, 32	5 ICLK
000C 130Eh	MTU0	Timer general register D	TGRD	16	16	5 ICLK
000C 1320h	MTU0	Timer general register E	TGRE	16	16, 32	5 ICLK
000C 1322h	MTU0	Timer general register F	TGRF	16	16	5 ICLK
000C 1324h	MTU0	Timer interrupt enable register 2	TIER2	8	8, 16	5 ICLK
000C 1325h	MTU0	Timer status register 2	TSR2	8	8	5 ICLK
000C 1326h	MTU0	Timer buffer operation transfer mode register	TBTM	8	8	5 ICLK
000C 1380h	MTU1	Timer control register	TCR	8	8, 16	5 ICLK
000C 1381h	MTU1	Timer mode register 1	TMDR1	8	8	5 ICLK
000C 1382h	MTU1	Timer I/O control register	TIOR	8	8	5 ICLK
000C 1384h	MTU1	Timer interrupt enable register	TIER	8	8, 16, 32	5 ICLK
000C 1385h	MTU1	Timer status register	TSR	8	8	5 ICLK
000C 1386h	MTU1	Timer counter	TCNT	16	16	5 ICLK
000C 1388h	MTU1	Timer general register A	TGRA	16	16, 32	5 ICLK
000C 138Ah	MTU1	Timer general register B	TGRB	16	16	5 ICLK

**Table 4.1 List of I/O Registers (Address Order) (18 / 25)**

Address	Module Abbreviation	Register Name	Register Abbreviation	Number of Bits	Access Size	Number of Access Cycles
000C 1390h	MTU1	Timer input capture control register	TICCR	8	8	5 ICLK
000C 1400h	MTU2	Timer control register	TCR	8	8, 16	5 ICLK
000C 1401h	MTU2	Timer mode register 1	TMDR1	8	8	5 ICLK
000C 1402h	MTU2	Timer I/O control register	TIOR	8	8	5 ICLK
000C 1404h	MTU2	Timer interrupt enable register	TIER	8	8, 16, 32	5 ICLK
000C 1405h	MTU2	Timer status register	TSR	8	8	5 ICLK
000C 1406h	MTU2	Timer counter	TCNT	16	16	5 ICLK
000C 1408h	MTU2	Timer general register A	TGRA	16	16, 32	5 ICLK
000C 140Ah	MTU2	Timer general register B	TGRB	16	16	5 ICLK
000C 1A00h	MTU6	Timer control register	TCR	8	8, 16, 32	5 ICLK
000C 1A01h	MTU7	Timer control register	TCR	8	8	5 ICLK
000C 1A02h	MTU6	Timer mode register 1	TMDR1	8	8, 16	5 ICLK
000C 1A03h	MTU7	Timer mode register 1	TMDR1	8	8	5 ICLK
000C 1A04h	MTU6	Timer I/O control register H	TIORH	8	8, 16, 32	5 ICLK
000C 1A05h	MTU6	Timer I/O control register L	TIORL	8	8	5 ICLK
000C 1A06h	MTU7	Timer I/O control register H	TIORH	8	8, 16	5 ICLK
000C 1A07h	MTU7	Timer I/O control register L	TIORL	8	8	5 ICLK
000C 1A08h	MTU6	Timer interrupt enable register	TIER	8	8, 16	5 ICLK
000C 1A09h	MTU7	Timer interrupt enable register	TIER	8	8	5 ICLK
000C 1A0Ah	MTU	Timer output master enable register B	TOERB	8	8	5 ICLK
000C 1A0Eh	MTU	Timer output control register 1B	TOCR1B	8	8, 16	5 ICLK
000C 1A0Fh	MTU	Timer output control register 2B	TOCR2B	8	8	5 ICLK
000C 1A10h	MTU6	Timer counter	TCNT	16	16, 32	5 ICLK
000C 1A12h	MTU7	Timer counter	TCNT	16	16	5 ICLK
000C 1A14h	MTU	Timer cycle data register B	TCDRB	16	16, 32	5 ICLK
000C 1A16h	MTU	Timer dead time data register B	TDDRB	16	16	5 ICLK
000C 1A18h	MTU6	Timer general register A	TGRA	16	16, 32	5 ICLK
000C 1A1Ah	MTU6	Timer general register B	TGRB	16	16	5 ICLK
000C 1A1Ch	MTU7	Timer general register A	TGRA	16	16, 32	5 ICLK
000C 1A1Eh	MTU7	Timer general register B	TGRB	16	16	5 ICLK
000C 1A20h	MTU	Timer subcounter B	TCNTSB	16	16, 32	5 ICLK
000C 1A22h	MTU	Timer cycle buffer register B	TCTBRB	16	16	5 ICLK
000C 1A24h	MTU6	Timer general register C	TGRC	16	16, 32	5 ICLK
000C 1A26h	MTU6	Timer general register D	TGRD	16	16	5 ICLK
000C 1A28h	MTU7	Timer general register C	TGRC	16	16, 32	5 ICLK
000C 1A2Ah	MTU7	Timer general register D	TGRD	16	16	5 ICLK
000C 1A2Ch	MTU6	Timer status register	TSR	8	8, 16	5 ICLK
000C 1A2Dh	MTU7	Timer status register	TSR	8	8	5 ICLK
000C 1A30h	MTU	Timer interrupt skipping set register 1B	TITCR1B	8	8, 16	5 ICLK
000C 1A31h	MTU	Timer interrupt skipping counter 1B	TITCNT1B	8	8	5 ICLK
000C 1A32h	MTU	Timer buffer transfer set register B	TBTERB	8	8	5 ICLK
000C 1A34h	MTU	Timer dead time enable register B	TDERB	8	8	5 ICLK
000C 1A36h	MTU	Timer output level buffer register B	TOLBRB	8	8	5 ICLK
000C 1A38h	MTU6	Timer buffer operation transfer mode register	TBTM	8	8, 16	5 ICLK

**Table 4.1 List of I/O Registers (Address Order) (19 / 25)**

Address	Module Abbreviation	Register Name	Register Abbreviation	Number of Bits	Access Size	Number of Access Cycles
000C 1A39h	MTU7	Timer buffer operation transfer mode register	TBTM	8	8	5 ICLK
000C 1A3Ah	MTU	Timer interrupt skipping mode register B	TITMRB	8	8	5 ICLK
000C 1A3Bh	MTU	Timer interrupt skipping set register 2B	TITCR2B	8	8	5 ICLK
000C 1A3Ch	MTU	Timer interrupt skipping counter 2B	TITCNT2B	8	8	5 ICLK
000C 1A40h	MTU7	Timer A/D converter start request control register	TADCR	16	16	5 ICLK
000C 1A44h	MTU7	Timer A/D converter start request cycle set register A	TADCORA	16	16, 32	5 ICLK
000C 1A46h	MTU7	Timer A/D converter start request cycle set register B	TADCORB	16	16	5 ICLK
000C 1A48h	MTU7	Timer A/D converter start request cycle set buffer register A	TADCOBRA	16	16, 32	5 ICLK
000C 1A4Ah	MTU7	Timer A/D converter start request cycle set buffer register B	TADCOBRB	16	16	5 ICLK
000C 1A50h	MTU6	Timer synchronous clear register	TSYCR	8	8	5 ICLK
000C 1A60h	MTU	Timer waveform control register B	TWCRB	8	8	5 ICLK
000C 1A70h	MTU	Timer mode register 2B	TMDR2B	8	8	5 ICLK
000C 1A72h	MTU6	Timer general register E	TGRE	16	16	5 ICLK
000C 1A74h	MTU7	Timer general register E	TGRE	16	16	5 ICLK
000C 1A76h	MTU7	Timer general register F	TGRF	16	16	5 ICLK
000C 1A80h	MTU	Timer start register B	TSTRB	8	8, 16	5 ICLK
000C 1A81h	MTU	Timer synchronous register B	TSYRB	8	8	5 ICLK
000C 1A84h	MTU	Timer read/write enable register B	TRWERB	8	8	5 ICLK
000C 1C80h	MTU5	Timer counter U	TCNTU	16	16, 32	5 ICLK
000C 1C82h	MTU5	Timer general register U	TGRU	16	16	5 ICLK
000C 1C84h	MTU5	Timer control register U	TCRU	8	8	5 ICLK
000C 1C86h	MTU5	Timer I/O control register U	TIORU	8	8	5 ICLK
000C 1C90h	MTU5	Timer counter V	TCNTV	16	16, 32	5 ICLK
000C 1C92h	MTU5	Timer general register V	TGRV	16	16	5 ICLK
000C 1C94h	MTU5	Timer control register V	TCRV	8	8	5 ICLK
000C 1C96h	MTU5	Timer I/O control register V	TIORV	8	8	5 ICLK
000C 1CA0h	MTU5	Timer counter W	TCNTW	16	16, 32	5 ICLK
000C 1CA2h	MTU5	Timer general register W	TGRW	16	16	5 ICLK
000C 1CA4h	MTU5	Timer control register W	TCRW	8	8	5 ICLK
000C 1CA6h	MTU5	Timer I/O control register W	TIORW	8	8	5 ICLK
000C 1CB0h	MTU5	Timer status register	TSR	8	8	5 ICLK
000C 1CB2h	MTU5	Timer interrupt enable register	TIER	8	8	5 ICLK
000C 1CB4h	MTU5	Timer start register	TSTR	8	8	5 ICLK
000C 1CB6h	MTU5	Timer compare match clear register	TCNTCMPCLR	8	8	5 ICLK
000C 2000h	GPT	General PWM timer software start register	GTSTR	16	8, 16, 32	3 to 5 ICLK <sup>*4</sup>
000C 2004h	GPT	General PWM timer hardware source start control register	GTHSCR	16	8, 16, 32	3 to 5 ICLK <sup>*4</sup>
000C 2006h	GPT	General PWM timer hardware source clear control register	GTHCCR	16	8, 16, 32	3 to 5 ICLK <sup>*4</sup>
000C 2008h	GPT	General PWM timer hardware start source select register	GTHSSR	16	8, 16, 32	3 to 5 ICLK <sup>*4</sup>

**Table 4.1 List of I/O Registers (Address Order) (20 / 25)**

Address	Module Abbreviation	Register Name	Register Abbreviation	Number of Bits	Access Size	Number of Access Cycles
000C 200Ah	GPT	General PWM timer hardware stop/clear source select register	GTHPSR	16	8, 16, 32	3 to 5 ICLK <sup>4</sup>
000C 200Ch	GPT	General PWM timer write-protection register	GTWP	16	8, 16, 32	3 to 5 ICLK <sup>4</sup>
000C 200Eh	GPT	General PWM timer sync register	GTSYNC	16	8, 16, 32	3 to 5 ICLK <sup>4</sup>
000C 2010h	GPT	General PWM timer external trigger input interrupt register	GTETINT	16	8, 16, 32	3 to 5 ICLK <sup>4</sup>
000C 2014h	GPT	General PWM timer buffer operation disable register	GTBDR	16	8, 16, 32	3 to 5 ICLK <sup>4</sup>
000C 2018h	GPT	General PWM timer start write protection register	GTSWP	16	16, 32	3 to 5 ICLK <sup>4</sup>
000C 2080h	GPT	LOCO count control register	LCCR	16	8, 16, 32	3 to 5 ICLK <sup>4</sup>
000C 2082h	GPT	LOCO count status register	LCST	16	8, 16, 32	3 to 5 ICLK <sup>4</sup>
000C 2084h	GPT	LOCO count value register	LCNT	16	8, 16, 32	3 to 5 ICLK <sup>4</sup>
000C 2086h	GPT	LOCO count result average register	LCNTA	16	8, 16, 32	3 to 5 ICLK <sup>4</sup>
000C 2088h	GPT	LOCO count result register 0	LCNT00	16	8, 16, 32	3 to 5 ICLK <sup>4</sup>
000C 208Ah	GPT	LOCO count result register 1	LCNT01	16	8, 16, 32	3 to 5 ICLK <sup>4</sup>
000C 208Ch	GPT	LOCO count result register 2	LCNT02	16	8, 16, 32	3 to 5 ICLK <sup>4</sup>
000C 208Eh	GPT	LOCO count result register 3	LCNT03	16	8, 16, 32	3 to 5 ICLK <sup>4</sup>
000C 2090h	GPT	LOCO count result register 4	LCNT04	16	8, 16, 32	3 to 5 ICLK <sup>4</sup>
000C 2092h	GPT	LOCO count result register 5	LCNT05	16	8, 16, 32	3 to 5 ICLK <sup>4</sup>
000C 2094h	GPT	LOCO count result register 6	LCNT06	16	8, 16, 32	3 to 5 ICLK <sup>4</sup>
000C 2096h	GPT	LOCO count result register 7	LCNT07	16	8, 16, 32	3 to 5 ICLK <sup>4</sup>
000C 2098h	GPT	LOCO count result register 8	LCNT08	16	8, 16, 32	3 to 5 ICLK <sup>4</sup>
000C 209Ah	GPT	LOCO count result register 9	LCNT09	16	8, 16, 32	3 to 5 ICLK <sup>4</sup>
000C 209Ch	GPT	LOCO count result register 10	LCNT10	16	8, 16, 32	3 to 5 ICLK <sup>4</sup>
000C 209Eh	GPT	LOCO count result register 11	LCNT11	16	8, 16, 32	3 to 5 ICLK <sup>4</sup>
000C 20A0h	GPT	LOCO count result register 12	LCNT12	16	8, 16, 32	3 to 5 ICLK <sup>4</sup>
000C 20A2h	GPT	LOCO count result register 13	LCNT13	16	8, 16, 32	3 to 5 ICLK <sup>4</sup>
000C 20A4h	GPT	LOCO count result register 14	LCNT14	16	8, 16, 32	3 to 5 ICLK <sup>4</sup>
000C 20A6h	GPT	LOCO count result register 15	LCNT15	16	8, 16, 32	3 to 5 ICLK <sup>4</sup>
000C 20A8h	GPT	LOCO count upper permissible deviation register	LCNTDU	16	8, 16, 32	3 to 5 ICLK <sup>4</sup>
000C 20AAh	GPT	LOCO count lower permissible deviation register	LCNTDL	16	8, 16, 32	3 to 5 ICLK <sup>4</sup>
000C 2100h	GPT0	General PWM timer I/O control register	GTIOR	16	8, 16, 32	3 to 5 ICLK <sup>4</sup>
000C 2102h	GPT0	General PWM timer interrupt output setting register	GTINTAD	16	8, 16, 32	3 to 5 ICLK <sup>4</sup>
000C 2104h	GPT0	General PWM timer control register	GTCCR	16	8, 16, 32	3 to 5 ICLK <sup>4</sup>
000C 2106h	GPT0	General PWM timer buffer enable register	GTBER	16	8, 16, 32	3 to 5 ICLK <sup>4</sup>
000C 2108h	GPT0	General PWM timer count direction register	GTUDC	16	8, 16, 32	3 to 5 ICLK <sup>4</sup>
000C 210Ah	GPT0	General PWM timer interrupt and A/D converter start request skipping setting register	GTITC	16	8, 16, 32	3 to 5 ICLK <sup>4</sup>
000C 210Ch	GPT0	General PWM timer status register	GTST	16	8, 16, 32	3 to 5 ICLK <sup>4</sup>
000C 210Eh	GPT0	General PWM timer counter	GTCNT	16	16	3 to 5 ICLK <sup>4</sup>
000C 2110h	GPT0	General PWM timer compare capture register A	GTCCRA	16	16, 32	3 to 5 ICLK <sup>4</sup>
000C 2112h	GPT0	General PWM timer compare capture register B	GTCCRB	16	16, 32	3 to 5 ICLK <sup>4</sup>
000C 2114h	GPT0	General PWM timer compare capture register C	GTCCRC	16	16, 32	3 to 5 ICLK <sup>4</sup>

**Table 4.1 List of I/O Registers (Address Order) (21 / 25)**

Address	Module Abbreviation	Register Name	Register Abbreviation	Number of Bits	Access Size	Number of Access Cycles
000C 2116h	GPT0	General PWM timer compare capture register D	GTCCRD	16	16, 32	3 to 5 ICLK <sup>*4</sup>
000C 2118h	GPT0	General PWM timer compare capture register E	GTCCRE	16	16, 32	3 to 5 ICLK <sup>*4</sup>
000C 211Ah	GPT0	General PWM timer compare capture register F	GTCCRF	16	16, 32	3 to 5 ICLK <sup>*4</sup>
000C 211Ch	GPT0	General PWM timer cycle setting register	GTPR	16	16, 32	3 to 5 ICLK <sup>*4</sup>
000C 211Eh	GPT0	General PWM timer cycle setting buffer register	GTPBR	16	16, 32	3 to 5 ICLK <sup>*4</sup>
000C 2120h	GPT0	General PWM timer cycle setting double-buffer register	GTPDBR	16	16, 32	3 to 5 ICLK <sup>*4</sup>
000C 2124h	GPT0	A/D converter start request timing register A	GTADTRA	16	16, 32	3 to 5 ICLK <sup>*4</sup>
000C 2126h	GPT0	A/D converter start request timing buffer register A	GTADTBRA	16	16, 32	3 to 5 ICLK <sup>*4</sup>
000C 2128h	GPT0	A/D converter start request timing double-buffer register A	GTADTBRA	16	16, 32	3 to 5 ICLK <sup>*4</sup>
000C 212Ch	GPT0	A/D converter start request timing register B	GTADTRB	16	16, 32	3 to 5 ICLK <sup>*4</sup>
000C 212Eh	GPT0	A/D converter start request timing buffer register B	GTADTRB	16	16, 32	3 to 5 ICLK <sup>*4</sup>
000C 2130h	GPT0	A/D converter start request timing double-buffer register B	GTADTRB	16	16, 32	3 to 5 ICLK <sup>*4</sup>
000C 2134h	GPT0	General PWM timer output negate control register	GTONCR	16	16, 32	3 to 5 ICLK <sup>*4</sup>
000C 2136h	GPT0	General PWM timer dead time control register	GTDTCR	16	16, 32	3 to 5 ICLK <sup>*4</sup>
000C 2138h	GPT0	General PWM timer dead time value register	GTDVU	16	16, 32	3 to 5 ICLK <sup>*4</sup>
000C 213Ah	GPT0	General PWM timer dead time value register	GTDVD	16	16, 32	3 to 5 ICLK <sup>*4</sup>
000C 213Ch	GPT0	General PWM timer dead time buffer register	GTDBU	16	16, 32	3 to 5 ICLK <sup>*4</sup>
000C 213Eh	GPT0	General PWM timer dead time buffer register	GTDBD	16	16, 32	3 to 5 ICLK <sup>*4</sup>
000C 2140h	GPT0	General PWM timer output protection function status register	GTSOS	16	16, 32	3 to 5 ICLK <sup>*4</sup>
000C 2142h	GPT0	General PWM timer output protection function temporary release register	GTSOTR	16	16, 32	3 to 5 ICLK <sup>*4</sup>
000C 2180h	GPT1	General PWM timer I/O control register	GTIOR	16	8, 16, 32	3 to 5 ICLK <sup>*4</sup>
000C 2182h	GPT1	General PWM timer interrupt output setting register	GTINTAD	16	8, 16, 32	3 to 5 ICLK <sup>*4</sup>
000C 2184h	GPT1	General PWM timer control register	GTCR	16	8, 16, 32	3 to 5 ICLK <sup>*4</sup>
000C 2186h	GPT1	General PWM timer buffer enable register	GTBER	16	8, 16, 32	3 to 5 ICLK <sup>*4</sup>
000C 2188h	GPT1	General PWM timer count direction register	GTUDC	16	8, 16, 32	3 to 5 ICLK <sup>*4</sup>
000C 218Ah	GPT1	General PWM timer interrupt and A/D converter start request skipping setting register	GTITC	16	8, 16, 32	3 to 5 ICLK <sup>*4</sup>
000C 218Ch	GPT1	General PWM timer status register	GTST	16	8, 16, 32	3 to 5 ICLK <sup>*4</sup>
000C 218Eh	GPT1	General PWM timer counter	GTCNT	16	16	3 to 5 ICLK <sup>*4</sup>
000C 2190h	GPT1	General PWM timer compare capture register A	GTCCRA	16	16, 32	3 to 5 ICLK <sup>*4</sup>
000C 2192h	GPT1	General PWM timer compare capture register B	GTCCRB	16	16, 32	3 to 5 ICLK <sup>*4</sup>
000C 2194h	GPT1	General PWM timer compare capture register C	GTCCRC	16	16, 32	3 to 5 ICLK <sup>*4</sup>
000C 2196h	GPT1	General PWM timer compare capture register D	GTCCRD	16	16, 32	3 to 5 ICLK <sup>*4</sup>
000C 2198h	GPT1	General PWM timer compare capture register E	GTCCRE	16	16, 32	3 to 5 ICLK <sup>*4</sup>
000C 219Ah	GPT1	General PWM timer compare capture register F	GTCCRF	16	16, 32	3 to 5 ICLK <sup>*4</sup>
000C 219Ch	GPT1	General PWM timer cycle setting register	GTPR	16	16, 32	3 to 5 ICLK <sup>*4</sup>
000C 219Eh	GPT1	General PWM timer cycle setting buffer register	GTPBR	16	16, 32	3 to 5 ICLK <sup>*4</sup>

**Table 4.1 List of I/O Registers (Address Order) (22 / 25)**

Address	Module Abbreviation	Register Name	Register Abbreviation	Number of Bits	Access Size	Number of Access Cycles
000C 21A0h	GPT1	General PWM timer cycle setting double-buffer register	GTPDDBR	16	16, 32	3 to 5 ICLK <sup>*4</sup>
000C 21A4h	GPT1	A/D converter start request timing register A	GTADTRA	16	16, 32	3 to 5 ICLK <sup>*4</sup>
000C 21A6h	GPT1	A/D converter start request timing buffer register A	GTADTBRA	16	16, 32	3 to 5 ICLK <sup>*4</sup>
000C 21A8h	GPT1	A/D converter start request timing double-buffer register A	GTADTDDBRA	16	16, 32	3 to 5 ICLK <sup>*4</sup>
000C 21ACh	GPT1	A/D converter start request timing register B	GTADTRB	16	16, 32	3 to 5 ICLK <sup>*4</sup>
000C 21AEh	GPT1	A/D converter start request timing buffer register B	GTADTBRB	16	16, 32	3 to 5 ICLK <sup>*4</sup>
000C 21B0h	GPT1	A/D converter start request timing double-buffer register B	GTADTDBRB	16	16, 32	3 to 5 ICLK <sup>*4</sup>
000C 21B4h	GPT1	General PWM timer output negate control register	GTONCR	16	16, 32	3 to 5 ICLK <sup>*4</sup>
000C 21B6h	GPT1	General PWM timer dead time control register	GTDTCR	16	16, 32	3 to 5 ICLK <sup>*4</sup>
000C 21B8h	GPT1	General PWM timer dead time value register	GTDVU	16	16, 32	3 to 5 ICLK <sup>*4</sup>
000C 21BAh	GPT1	General PWM timer dead time value register	GTDVD	16	16, 32	3 to 5 ICLK <sup>*4</sup>
000C 21BCh	GPT1	General PWM timer dead time buffer register	GTDBU	16	16, 32	3 to 5 ICLK <sup>*4</sup>
000C 21BEh	GPT1	General PWM timer dead time buffer register	GTDBD	16	16, 32	3 to 5 ICLK <sup>*4</sup>
000C 21C0h	GPT1	General PWM timer output protection function status register	GTSOS	16	16, 32	3 to 5 ICLK <sup>*4</sup>
000C 21C2h	GPT1	General PWM timer output protection temporary release register	GTSOTR	16	16, 32	3 to 5 ICLK <sup>*4</sup>
000C 2200h	GPT2	General PWM timer I/O control register	GTIOR	16	8, 16, 32	3 to 5 ICLK <sup>*4</sup>
000C 2202h	GPT2	General PWM timer interrupt output setting register	GTINTAD	16	8, 16, 32	3 to 5 ICLK <sup>*4</sup>
000C 2204h	GPT2	General PWM timer control register	GTCR	16	8, 16, 32	3 to 5 ICLK <sup>*4</sup>
000C 2206h	GPT2	General PWM timer buffer enable register	GTBER	16	8, 16, 32	3 to 5 ICLK <sup>*4</sup>
000C 2208h	GPT2	General PWM timer count direction register	GTUDC	16	8, 16, 32	3 to 5 ICLK <sup>*4</sup>
000C 220Ah	GPT2	General PWM timer interrupt and A/D converter start request skipping setting register	GTITC	16	8, 16, 32	3 to 5 ICLK <sup>*4</sup>
000C 220Ch	GPT2	General PWM timer status register	GTST	16	8, 16, 32	3 to 5 ICLK <sup>*4</sup>
000C 220Eh	GPT2	General PWM timer counter	GTCNT	16	16	3 to 5 ICLK <sup>*4</sup>
000C 2210h	GPT2	General PWM timer compare capture register A	GTCCRA	16	16, 32	3 to 5 ICLK <sup>*4</sup>
000C 2212h	GPT2	General PWM timer compare capture register B	GTCCRB	16	16, 32	3 to 5 ICLK <sup>*4</sup>
000C 2214h	GPT2	General PWM timer compare capture register C	GTCCRC	16	16, 32	3 to 5 ICLK <sup>*4</sup>
000C 2216h	GPT2	General PWM timer compare capture register D	GTCCRD	16	16, 32	3 to 5 ICLK <sup>*4</sup>
000C 2218h	GPT2	General PWM timer compare capture register E	GTCCRE	16	16, 32	3 to 5 ICLK <sup>*4</sup>
000C 221Ah	GPT2	General PWM timer compare capture register F	GTCCRF	16	16, 32	3 to 5 ICLK <sup>*4</sup>
000C 221Ch	GPT2	General PWM timer cycle setting register	GTPR	16	16, 32	3 to 5 ICLK <sup>*4</sup>
000C 221Eh	GPT2	General PWM timer cycle setting buffer register	GTPBR	16	16, 32	3 to 5 ICLK <sup>*4</sup>
000C 2220h	GPT2	General PWM timer cycle setting double-buffer register	GTPDDBR	16	16, 32	3 to 5 ICLK <sup>*4</sup>
000C 2224h	GPT2	A/D converter start request timing register A	GTADTRA	16	16, 32	3 to 5 ICLK <sup>*4</sup>
000C 2226h	GPT2	A/D converter start request timing buffer register A	GTADTBRA	16	16, 32	3 to 5 ICLK <sup>*4</sup>
000C 2228h	GPT2	A/D converter start request timing double-buffer register A	GTADTDDBRA	16	16, 32	3 to 5 ICLK <sup>*4</sup>



**Table 4.1 List of I/O Registers (Address Order) (23 / 25)**

Address	Module Abbreviation	Register Name	Register Abbreviation	Number of Bits	Access Size	Number of Access Cycles
000C 222Ch	GPT2	A/D converter start request timing register B	GTADTRB	16	16, 32	3 to 5 ICLK <sup>4</sup>
000C 222Eh	GPT2	A/D converter start request timing buffer register B	GTADTBRB	16	16, 32	3 to 5 ICLK <sup>4</sup>
000C 2230h	GPT2	A/D converter start request timing double-buffer register B	GTADTDBRB	16	16, 32	3 to 5 ICLK <sup>4</sup>
000C 2234h	GPT2	General PWM timer output negate control register	GTONCR	16	16, 32	3 to 5 ICLK <sup>4</sup>
000C 2236h	GPT2	General PWM timer dead time control register	GTDTCR	16	16, 32	3 to 5 ICLK <sup>4</sup>
000C 2238h	GPT2	General PWM timer dead time value register	GTDVU	16	16, 32	3 to 5 ICLK <sup>4</sup>
000C 223Ah	GPT2	General PWM timer dead time value register	GTDVD	16	16, 32	3 to 5 ICLK <sup>4</sup>
000C 223Ch	GPT2	General PWM timer dead time buffer register	GTDBU	16	16, 32	3 to 5 ICLK <sup>4</sup>
000C 223Eh	GPT2	General PWM timer dead time buffer register	GTDBD	16	16, 32	3 to 5 ICLK <sup>4</sup>
000C 2240h	GPT2	General PWM timer output protection function status register	GTSOS	16	16, 32	3 to 5 ICLK <sup>4</sup>
000C 2242h	GPT2	General PWM timer output protection temporary release register	GTSOTR	16	16, 32	3 to 5 ICLK <sup>4</sup>
000C 2280h	GPT3	General PWM timer I/O control register	GTIOR	16	8, 16, 32	3 to 5 ICLK <sup>4</sup>
000C 2282h	GPT3	General PWM timer interrupt output setting register	GTINTAD	16	8, 16, 32	3 to 5 ICLK <sup>4</sup>
000C 2284h	GPT3	General PWM timer control register	GTCR	16	8, 16, 32	3 to 5 ICLK <sup>4</sup>
000C 2286h	GPT3	General PWM timer buffer enable register	GTBER	16	8, 16, 32	3 to 5 ICLK <sup>4</sup>
000C 2288h	GPT3	General PWM timer count direction register	GTUDC	16	8, 16, 32	3 to 5 ICLK <sup>4</sup>
000C 228Ah	GPT3	General PWM timer interrupt and A/D converter start request skipping setting register	GTITC	16	8, 16, 32	3 to 5 ICLK <sup>4</sup>
000C 228Ch	GPT3	General PWM timer status register	GTST	16	8, 16, 32	3 to 5 ICLK <sup>4</sup>
000C 228Eh	GPT3	General PWM timer counter	GTCNT	16	16	3 to 5 ICLK <sup>4</sup>
000C 2290h	GPT3	General PWM timer compare capture register A	GTCCRA	16	16, 32	3 to 5 ICLK <sup>4</sup>
000C 2292h	GPT3	General PWM timer compare capture register B	GTCCRB	16	16, 32	3 to 5 ICLK <sup>4</sup>
000C 2294h	GPT3	General PWM timer compare capture register C	GTCCRC	16	16, 32	3 to 5 ICLK <sup>4</sup>
000C 2296h	GPT3	General PWM timer compare capture register D	GTCCRD	16	16, 32	3 to 5 ICLK <sup>4</sup>
000C 2298h	GPT3	General PWM timer compare capture register E	GTCCRE	16	16, 32	3 to 5 ICLK <sup>4</sup>
000C 229Ah	GPT3	General PWM timer compare capture register F	GTCCRF	16	16, 32	3 to 5 ICLK <sup>4</sup>
000C 229Ch	GPT3	General PWM timer cycle setting register	GTPR	16	16, 32	3 to 5 ICLK <sup>4</sup>
000C 229Eh	GPT3	General PWM timer cycle setting buffer register	GTPBR	16	16, 32	3 to 5 ICLK <sup>4</sup>
000C 22A0h	GPT3	General PWM timer cycle setting double-buffer register	GTPDBR	16	16, 32	3 to 5 ICLK <sup>4</sup>
000C 22A4h	GPT3	A/D converter start request timing register A	GTADTRA	16	16, 32	3 to 5 ICLK <sup>4</sup>
000C 22A6h	GPT3	A/D converter start request timing buffer register A	GTADTBRA	16	16, 32	3 to 5 ICLK <sup>4</sup>
000C 22A8h	GPT3	A/D converter start request timing double-buffer register A	GTADTBRA	16	16, 32	3 to 5 ICLK <sup>4</sup>
000C 22ACh	GPT3	A/D converter start request timing register B	GTADTRB	16	16, 32	3 to 5 ICLK <sup>4</sup>
000C 22AEh	GPT3	A/D converter start request timing buffer register B	GTADTBRB	16	16, 32	3 to 5 ICLK <sup>4</sup>
000C 22B0h	GPT3	A/D converter start request timing double-buffer register B	GTADTDBRB	16	16, 32	3 to 5 ICLK <sup>4</sup>
000C 22B4h	GPT3	General PWM timer output negate control register	GTONCR	16	16, 32	3 to 5 ICLK <sup>4</sup>

**Table 4.1 List of I/O Registers (Address Order) (24 / 25)**

Address	Module Abbreviation	Register Name	Register Abbreviation	Number of Bits	Access Size	Number of Access Cycles
000C 22B6h	GPT3	General PWM timer dead time control register	GTDTCR	16	16, 32	3 to 5 ICLK <sup>*4</sup>
000C 22B8h	GPT3	General PWM timer dead time value register	GTDVU	16	16, 32	3 to 5 ICLK <sup>*4</sup>
000C 22BAh	GPT3	General PWM timer dead time value register	GTDVD	16	16, 32	3 to 5 ICLK <sup>*4</sup>
000C 22BC h	GPT3	General PWM timer dead time buffer register	GTDBU	16	16, 32	3 to 5 ICLK <sup>*4</sup>
000C 22BEh	GPT3	General PWM timer dead time buffer register	GTDBD	16	16, 32	3 to 5 ICLK <sup>*4</sup>
000C 22C0h	GPT3	General PWM timer output protection function status register	GTSOS	16	16, 32	3 to 5 ICLK <sup>*4</sup>
000C 22C2h	GPT3	General PWM timer output protection temporary release register	GTSOTR	16	16, 32	3 to 5 ICLK <sup>*4</sup>
000C 2300h	GPT0	PWM output delay control register	GTDLYCR	16	16, 32	3 to 5 ICLK <sup>*4</sup>
000C 2302h	GPT1	PWM output delay control register	GTDLYCR	16	16, 32	3 to 5 ICLK <sup>*4</sup>
000C 2304h	GPT2	PWM output delay control register	GTDLYCR	16	16, 32	3 to 5 ICLK <sup>*4</sup>
000C 2306h	GPT3	PWM output delay control register	GTDLYCR	16	16, 32	3 to 5 ICLK <sup>*4</sup>
000C 2318h	GPT0	GTIOCA rising output delay register	GTDLYRA	16	16, 32	3 to 5 ICLK <sup>*4</sup>
000C 231Ah	GPT0	GTIOCB rising output delay register	GTDLYRB	16	16, 32	3 to 5 ICLK <sup>*4</sup>
000C 231Ch	GPT1	GTIOCA rising output delay register	GTDLYRA	16	16, 32	3 to 5 ICLK <sup>*4</sup>
000C 231Eh	GPT1	GTIOCB rising output delay register	GTDLYRB	16	16, 32	3 to 5 ICLK <sup>*4</sup>
000C 2320h	GPT2	GTIOCA rising output delay register	GTDLYRA	16	16, 32	3 to 5 ICLK <sup>*4</sup>
000C 2322h	GPT2	GTIOCB rising output delay register	GTDLYRB	16	16, 32	3 to 5 ICLK <sup>*4</sup>
000C 2324h	GPT3	GTIOCA falling output delay register	GTDLYRA	16	16, 32	3 to 5 ICLK <sup>*4</sup>
000C 2326h	GPT3	GTIOCB falling output delay register	GTDLYRB	16	16, 32	3 to 5 ICLK <sup>*4</sup>
000C 2328h	GPT0	GTIOCA falling output delay register	GTDLYFA	16	16, 32	3 to 5 ICLK <sup>*4</sup>
000C 232Ah	GPT0	GTIOCB falling output delay register	GTDLYFB	16	16, 32	3 to 5 ICLK <sup>*4</sup>
000C 232Ch	GPT1	GTIOCA falling output delay register	GTDLYFA	16	16, 32	3 to 5 ICLK <sup>*4</sup>
000C 232Eh	GPT1	GTIOCB falling output delay register	GTDLYFB	16	16, 32	3 to 5 ICLK <sup>*4</sup>
000C 2330h	GPT2	GTIOCA falling output delay register	GTDLYFA	16	16, 32	3 to 5 ICLK <sup>*4</sup>
000C 2332h	GPT2	GTIOCB falling output delay register	GTDLYFB	16	16, 32	3 to 5 ICLK <sup>*4</sup>
000C 2334h	GPT3	GTIOCA falling output delay register	GTDLYFA	16	16, 32	3 to 5 ICLK <sup>*4</sup>
000C 2336h	GPT3	GTIOCB falling output delay register	GTDLYFB	16	16, 32	3 to 5 ICLK <sup>*4</sup>
007F C402h	FLASH	Flash mode register	FMODR	8	8	2, 3 PCLK <sup>*3</sup>
007F C410h	FLASH	Flash access status register	FASTAT	8	8	2, 3 PCLK <sup>*3</sup>
007F C411h	FLASH	Flash access error interrupt enable register	FAEINT	8	8	2, 3 PCLK <sup>*3</sup>
007F C412h	FLASH	Flash ready interrupt enable register	FRDYIE	8	8	2, 3 PCLK <sup>*3</sup>
007F C440h	FLASH	Data flash read enable register 0	DFLRE0	16	16	2, 3 PCLK <sup>*3</sup>
007F C442h	FLASH	Data flash read enable register 1	DFLRE1	16	16	2, 3 PCLK <sup>*3</sup>
007F C450h	FLASH	Data flash programming/erasure enable register 0	DFLWE0	16	16	2, 3 PCLK <sup>*3</sup>
007F C452h	FLASH	Data flash programming/erasure enable register 1	DFLWE1	16	16	2, 3 PCLK <sup>*3</sup>
007F C454h	FLASH	FCU RAM enable register	FCURAME	16	16	2, 3 PCLK <sup>*3</sup>
007F FFB0h	FLASH	Flash status register 0	FSTATR0	8	8	2, 3 PCLK <sup>*3</sup>
007F FFB1h	FLASH	Flash status register 1	FSTATR1	8	8	2, 3 PCLK <sup>*3</sup>
007F FFB2h	FLASH	Flash P/E mode entry register	FENTRYR	16	16	2, 3 PCLK <sup>*3</sup>
007F FFB4h	FLASH	Flash protect register	FPROTR	16	16	2, 3 PCLK <sup>*3</sup>
007F FFB6h	FLASH	Flash reset register	FRESETR	16	16	2, 3 PCLK <sup>*3</sup>

**Table 4.1 List of I/O Registers (Address Order) (25 / 25)**

Address	Module Abbreviation	Register Name	Register Abbreviation	Number of Bits	Access Size	Number of Access Cycles
007F FFBAh	FLASH	FCU command register	FCMDR	16	16	2, 3 PCLK <sup>*3</sup>
007F FFC8h	FLASH	FCU processing switching register	FCPSR	16	16	2, 3 PCLK <sup>*3</sup>
007F FFCAh	FLASH	Data flash blank check control register	DFLBCCNT	16	16	2, 3 PCLK <sup>*3</sup>
007F FFCCh	FLASH	Flash P/E status register	FPESTAT	16	16	2, 3 PCLK <sup>*3</sup>
007F FFCEh	FLASH	Data flash blank check status register	DFLBCSTAT	16	16	2, 3 PCLK <sup>*3</sup>
007F FFE8h	FLASH	Peripheral clock notification register	PCKAR	16	16	2, 3 PCLK <sup>*3</sup>

Note 1. This register is not supported by the 100-pin LQFP version.

Note 2. This register is not supported by the product without the CAN function.

Note 3. The number of access states depends on the number of divided cycles for clock synchronization (0 to 1 PCLK).

Note 4. Reading the registers takes 3 cycles of ICLK and writing to the registers takes 5 cycles of ICLK.

## 4.2 I/O Register Bits

Register addresses and bit names of the peripheral modules are described below.

Each line cover eight bits, and 16-bit and 32-bit registers are shown as 2 or 4 lines, respectively.

**Table 4.2 List of I/O Registers (Bit Order) (1 / 30)**

Module Abbreviation	Register Abbreviation	Bit 31/23/15/7	Bit 30/22/14/6	Bit 29/21/13/5	Bit 28/20/12/4	Bit 27/19/11/3	Bit 26/18/10/2	Bit 25/17/9/1	Bit 24/16/8/0
SYSTEM	MDMONR	—	—	—	—	—	—	—	—
		MDE	—	—	—	—	—	MD1	MD0
SYSTEM	MDSR	—	—	—	—	—	—	—	—
		—	—	—	BOTS	—	—	—	IROM
SYSTEM	SYSCR0	KEY[7:0]							
SYSTEM	SYSCR1	—	—	—	—	—	—	—	ROME
		—	—	—	—	—	—	—	RAME
SYSTEM	SBYCR	SSBY	—	—	—	—	—	STS[4:0]	—
		—	—	—	—	—	—	—	—
SYSTEM	MSTPCRA	ACSE	—	—	MSTPA28	—	—	—	MSTPA24
		MSTPA23	—	—	—	—	—	MSTPA17	MSTPA16
		MSTPA15	MSTPA14	—	—	—	—	MSTPA9	—
		MSTPA7	—	—	—	—	—	—	—
SYSTEM	MSTPCRB	MSTPB31	MSTPB30	MSTPB29	—	—	—	—	—
		MSTPB23	—	MSTPB21	—	—	—	MSTPB17	—
		—	—	—	—	—	—	—	—
		MSTPB7	—	—	—	—	—	—	MSTPB0
SYSTEM	MSTPCRC	—	—	—	—	—	—	—	—
		—	—	—	—	—	—	—	—
		—	—	—	—	—	—	—	—
		—	—	—	—	—	—	—	MSTPC0
SYSTEM	SCKCR	—	—	—	—	—	—	ICK[3:0]	—
		—	—	—	—	—	—	—	—
		—	—	—	—	—	—	PCK[3:0]	—
		—	—	—	—	—	—	—	—
SYSTEM	OSTDCR	KEY[7:0]							
BSC	BERCLR	—	—	—	—	—	—	—	STSCLR
		—	—	—	—	—	—	—	IGAEN
BSC	BERSR1	—	—	MST[2:0]	—	—	—	IA	
BSC	BERSR2	ADDR[12:0]						—	—
		ADDR[12:0]						—	—
DTC	DTCCR	—	—	—	RRS	—	—	—	
DTC	DTCVBR								
DTC	DTCADMOD	—	—	—	—	—	—	—	SHORT
DTC	DTCST	—	—	—	—	—	—	—	DTCST
DTC	DTCSTS	ACT	—	—	—	—	—	—	—
		VECN[7:0]							
		RSPN[27:0]							
		RSPN[27:0]							
MPU	RSPAGE0	RSPN[27:0]							
		RSPN[27:0]							

**Table 4.2 List of I/O Registers (Bit Order) (2 / 30)**

Module Abbreviation	Register Abbreviation	Bit 31/23/15/7	Bit 30/22/14/6	Bit 29/21/13/5	Bit 28/20/12/4	Bit 27/19/11/3	Bit 26/18/10/2	Bit 25/17/9/1	Bit 24/16/8/0
MPU	REPAGE0					REPN[27:0]			
						REPN[27:0]			
						REPN[27:0]			
				REPN[27:0]			UAC[2:0]		V
MPU	RSPAGE1					RSPN[27:0]			
						RSPN[27:0]			
						RSPN[27:0]			
				RSPN[27:0]		—	—	—	—
MPU	REPAGE1					REPN[27:0]			
						REPN[27:0]			
						REPN[27:0]			
				REPN[27:0]			UAC[2:0]		V
MPU	RSPAGE2					RSPN[27:0]			
						RSPN[27:0]			
						RSPN[27:0]			
				RSPN[27:0]		—	—	—	—
MPU	REPAGE2					REPN[27:0]			
						REPN[27:0]			
						REPN[27:0]			
				REPN[27:0]			UAC[2:0]		V
MPU	RSPAGE3					RSPN[27:0]			
						RSPN[27:0]			
						RSPN[27:0]			
				RSPN[27:0]		—	—	—	—
MPU	REPAGE3					REPN[27:0]			
						REPN[27:0]			
						REPN[27:0]			
				REPN[27:0]			UAC[2:0]		V
MPU	RSPAGE4					RSPN[27:0]			
						RSPN[27:0]			
						RSPN[27:0]			
				RSPN[27:0]		—	—	—	—
MPU	REPAGE4					REPN[27:0]			
						REPN[27:0]			
						REPN[27:0]			
				REPN[27:0]			UAC[2:0]		V
MPU	RSPAGE5					RSPN[27:0]			
						RSPN[27:0]			
						RSPN[27:0]			
				RSPN[27:0]		—	—	—	—
MPU	REPAGE5					REPN[27:0]			
						REPN[27:0]			
						REPN[27:0]			
				REPN[27:0]			UAC[2:0]		V
MPU	RSPAGE6					RSPN[27:0]			
						RSPN[27:0]			
						RSPN[27:0]			
				RSPN[27:0]		—	—	—	—
MPU	REPAGE6					REPN[27:0]			
						REPN[27:0]			
						REPN[27:0]			
				REPN[27:0]			UAC[2:0]		V

**Table 4.2 List of I/O Registers (Bit Order) (3 / 30)**

Module Abbreviation	Register Abbreviation	Bit 31/23/15/7	Bit 30/22/14/6	Bit 29/21/13/5	Bit 28/20/12/4	Bit 27/19/11/3	Bit 26/18/10/2	Bit 25/17/9/1	Bit 24/16/8/0
MPU	RSPAGE7					RSPN[27:0]			
						RSPN[27:0]			
						RSPN[27:0]			
					RSPN[27:0]		—	—	—
MPU	REPAGE7					REPN[27:0]			
						REPN[27:0]			
						REPN[27:0]			
					REPN[27:0]		UAC[2:0]		V
MPU	MPEN	—	—	—	—	—	—	—	—
		—	—	—	—	—	—	—	—
		—	—	—	—	—	—	—	—
		—	—	—	—	—	—	—	MPEN
MPU	MPBAC	—	—	—	—	—	—	—	—
		—	—	—	—	—	—	—	—
		—	—	—	—	—	—	—	—
		—	—	—	—	—	UBAC[2:0]		—
MPU	MPECLR	—	—	—	—	—	—	—	—
		—	—	—	—	—	—	—	—
		—	—	—	—	—	—	—	—
		—	—	—	—	—	—	—	CLR
MPU	MPESTS	—	—	—	—	—	—	—	—
		—	—	—	—	—	—	—	—
		—	—	—	—	—	—	—	—
		—	—	—	—	—	DRW	DA	IA
MPU	MPDEA					DEA[31:0]			
						DEA[31:0]			
						DEA[31:0]			
						DEA[31:0]			
MPU	MPSA					SA[31:0]			
						SA[31:0]			
						SA[31:0]			
						SA[31:0]			
MPU	MPOPS	—	—	—	—	—	—	—	—
		—	—	—	—	—	—	—	S
MPU	MPOPI	—	—	—	—	—	—	—	—
		—	—	—	—	—	—	—	INV
MPU	MHITI	—	—	—	—	—	—	—	—
						HITI[7:0]			
		—	—	—	—	—	—	—	—
		—	—	—	—	—	UHACI[2:0]		—
MPU	MHITD	—	—	—	—	—	—	—	—
						HITD[7:0]			
		—	—	—	—	—	—	—	—
		—	—	—	—	—	UHACD[2:0]		—
ICU	IR016	—	—	—	—	—	—	—	IR
ICU	IR021	—	—	—	—	—	—	—	IR
ICU	IR023	—	—	—	—	—	—	—	IR
ICU	IR027	—	—	—	—	—	—	—	IR
ICU	IR028	—	—	—	—	—	—	—	IR
ICU	IR029	—	—	—	—	—	—	—	IR
ICU	IR030	—	—	—	—	—	—	—	IR
ICU	IR031	—	—	—	—	—	—	—	IR

**Table 4.2 List of I/O Registers (Bit Order) (4 / 30)**

Module Abbreviation	Register Abbreviation	Bit 31/23/15/7	Bit 30/22/14/6	Bit 29/21/13/5	Bit 28/20/12/4	Bit 27/19/11/3	Bit 26/18/10/2	Bit 25/17/9/1	Bit 24/16/8/0
ICU	IR044	—	—	—	—	—	—	—	IR
ICU	IR045	—	—	—	—	—	—	—	IR
ICU	IR046	—	—	—	—	—	—	—	IR
ICU	IR047	—	—	—	—	—	—	—	IR
ICU	IR056	—	—	—	—	—	—	—	IR
ICU	IR057	—	—	—	—	—	—	—	IR
ICU	IR058	—	—	—	—	—	—	—	IR
ICU	IR059	—	—	—	—	—	—	—	IR
ICU	IR060	—	—	—	—	—	—	—	IR
ICU	IR064	—	—	—	—	—	—	—	IR
ICU	IR065	—	—	—	—	—	—	—	IR
ICU	IR066	—	—	—	—	—	—	—	IR
ICU	IR067	—	—	—	—	—	—	—	IR
ICU	IR068	—	—	—	—	—	—	—	IR
ICU	IR069	—	—	—	—	—	—	—	IR
ICU	IR070	—	—	—	—	—	—	—	IR
ICU	IR071	—	—	—	—	—	—	—	IR
ICU	IR096	—	—	—	—	—	—	—	IR
ICU	IR098	—	—	—	—	—	—	—	IR
ICU	IR102	—	—	—	—	—	—	—	IR
ICU	IR103	—	—	—	—	—	—	—	IR
ICU	IR106	—	—	—	—	—	—	—	IR
ICU	IR114	—	—	—	—	—	—	—	IR
ICU	IR115	—	—	—	—	—	—	—	IR
ICU	IR116	—	—	—	—	—	—	—	IR
ICU	IR117	—	—	—	—	—	—	—	IR
ICU	IR118	—	—	—	—	—	—	—	IR
ICU	IR119	—	—	—	—	—	—	—	IR
ICU	IR120	—	—	—	—	—	—	—	IR
ICU	IR121	—	—	—	—	—	—	—	IR
ICU	IR122	—	—	—	—	—	—	—	IR
ICU	IR123	—	—	—	—	—	—	—	IR
ICU	IR124	—	—	—	—	—	—	—	IR
ICU	IR125	—	—	—	—	—	—	—	IR
ICU	IR126	—	—	—	—	—	—	—	IR
ICU	IR127	—	—	—	—	—	—	—	IR
ICU	IR128	—	—	—	—	—	—	—	IR
ICU	IR129	—	—	—	—	—	—	—	IR
ICU	IR130	—	—	—	—	—	—	—	IR
ICU	IR131	—	—	—	—	—	—	—	IR
ICU	IR132	—	—	—	—	—	—	—	IR
ICU	IR133	—	—	—	—	—	—	—	IR
ICU	IR134	—	—	—	—	—	—	—	IR
ICU	IR135	—	—	—	—	—	—	—	IR
ICU	IR136	—	—	—	—	—	—	—	IR
ICU	IR137	—	—	—	—	—	—	—	IR
ICU	IR138	—	—	—	—	—	—	—	IR
ICU	IR139	—	—	—	—	—	—	—	IR
ICU	IR140	—	—	—	—	—	—	—	IR
ICU	IR141	—	—	—	—	—	—	—	IR
ICU	IR142	—	—	—	—	—	—	—	IR
ICU	IR143	—	—	—	—	—	—	—	IR

**Table 4.2 List of I/O Registers (Bit Order) (5 / 30)**

Module Abbreviation	Register Abbreviation	Bit 31/23/15/7	Bit 30/22/14/6	Bit 29/21/13/5	Bit 28/20/12/4	Bit 27/19/11/3	Bit 26/18/10/2	Bit 25/17/9/1	Bit 24/16/8/0
ICU	IR144	—	—	—	—	—	—	—	IR
ICU	IR145	—	—	—	—	—	—	—	IR
ICU	IR146	—	—	—	—	—	—	—	IR
ICU	IR149	—	—	—	—	—	—	—	IR
ICU	IR150	—	—	—	—	—	—	—	IR
ICU	IR151	—	—	—	—	—	—	—	IR
ICU	IR152	—	—	—	—	—	—	—	IR
ICU	IR153	—	—	—	—	—	—	—	IR
ICU	IR170	—	—	—	—	—	—	—	IR
ICU	IR171	—	—	—	—	—	—	—	IR
ICU	IR172	—	—	—	—	—	—	—	IR
ICU	IR173	—	—	—	—	—	—	—	IR
ICU	IR174	—	—	—	—	—	—	—	IR
ICU	IR175	—	—	—	—	—	—	—	IR
ICU	IR176	—	—	—	—	—	—	—	IR
ICU	IR177	—	—	—	—	—	—	—	IR
ICU	IR178	—	—	—	—	—	—	—	IR
ICU	IR179	—	—	—	—	—	—	—	IR
ICU	IR180	—	—	—	—	—	—	—	IR
ICU	IR181	—	—	—	—	—	—	—	IR
ICU	IR182	—	—	—	—	—	—	—	IR
ICU	IR183	—	—	—	—	—	—	—	IR
ICU	IR184	—	—	—	—	—	—	—	IR
ICU	IR186	—	—	—	—	—	—	—	IR
ICU	IR187	—	—	—	—	—	—	—	IR
ICU	IR188	—	—	—	—	—	—	—	IR
ICU	IR189	—	—	—	—	—	—	—	IR
ICU	IR190	—	—	—	—	—	—	—	IR
ICU	IR192	—	—	—	—	—	—	—	IR
ICU	IR193	—	—	—	—	—	—	—	IR
ICU	IR194	—	—	—	—	—	—	—	IR
ICU	IR195	—	—	—	—	—	—	—	IR
ICU	IR196	—	—	—	—	—	—	—	IR
ICU	IR214	—	—	—	—	—	—	—	IR
ICU	IR215	—	—	—	—	—	—	—	IR
ICU	IR216	—	—	—	—	—	—	—	IR
ICU	IR217	—	—	—	—	—	—	—	IR
ICU	IR218	—	—	—	—	—	—	—	IR
ICU	IR219	—	—	—	—	—	—	—	IR
ICU	IR220	—	—	—	—	—	—	—	IR
ICU	IR221	—	—	—	—	—	—	—	IR
ICU	IR222	—	—	—	—	—	—	—	IR
ICU	IR223	—	—	—	—	—	—	—	IR
ICU	IR224	—	—	—	—	—	—	—	IR
ICU	IR225	—	—	—	—	—	—	—	IR
ICU	IR246	—	—	—	—	—	—	—	IR
ICU	IR247	—	—	—	—	—	—	—	IR
ICU	IR248	—	—	—	—	—	—	—	IR
ICU	IR249	—	—	—	—	—	—	—	IR
ICU	IR254	—	—	—	—	—	—	—	IR
ICU	DTCER027	—	—	—	—	—	—	—	DTCE
ICU	DTCER028	—	—	—	—	—	—	—	DTCE



**Table 4.2 List of I/O Registers (Bit Order) (6 / 30)**

Module Abbreviation	Register Abbreviation	Bit 31/23/15/7	Bit 30/22/14/6	Bit 29/21/13/5	Bit 28/20/12/4	Bit 27/19/11/3	Bit 26/18/10/2	Bit 25/17/9/1	Bit 24/16/8/0
ICU	DTCER029	—	—	—	—	—	—	—	DTCE
ICU	DTCER030	—	—	—	—	—	—	—	DTCE
ICU	DTCER031	—	—	—	—	—	—	—	DTCE
ICU	DTCER045	—	—	—	—	—	—	—	DTCE
ICU	DTCER046	—	—	—	—	—	—	—	DTCE
ICU	DTCER064	—	—	—	—	—	—	—	DTCE
ICU	DTCER065	—	—	—	—	—	—	—	DTCE
ICU	DTCER066	—	—	—	—	—	—	—	DTCE
ICU	DTCER067	—	—	—	—	—	—	—	DTCE
ICU	DTCER068	—	—	—	—	—	—	—	DTCE
ICU	DTCER069	—	—	—	—	—	—	—	DTCE
ICU	DTCER070	—	—	—	—	—	—	—	DTCE
ICU	DTCER071	—	—	—	—	—	—	—	DTCE
ICU	DTCER098	—	—	—	—	—	—	—	DTCE
ICU	DTCER102	—	—	—	—	—	—	—	DTCE
ICU	DTCER103	—	—	—	—	—	—	—	DTCE
ICU	DTCER106	—	—	—	—	—	—	—	DTCE
ICU	DTCER114	—	—	—	—	—	—	—	DTCE
ICU	DTCER115	—	—	—	—	—	—	—	DTCE
ICU	DTCER116	—	—	—	—	—	—	—	DTCE
ICU	DTCER117	—	—	—	—	—	—	—	DTCE
ICU	DTCER121	—	—	—	—	—	—	—	DTCE
ICU	DTCER122	—	—	—	—	—	—	—	DTCE
ICU	DTCER125	—	—	—	—	—	—	—	DTCE
ICU	DTCER126	—	—	—	—	—	—	—	DTCE
ICU	DTCER129	—	—	—	—	—	—	—	DTCE
ICU	DTCER130	—	—	—	—	—	—	—	DTCE
ICU	DTCER131	—	—	—	—	—	—	—	DTCE
ICU	DTCER132	—	—	—	—	—	—	—	DTCE
ICU	DTCER134	—	—	—	—	—	—	—	DTCE
ICU	DTCER135	—	—	—	—	—	—	—	DTCE
ICU	DTCER136	—	—	—	—	—	—	—	DTCE
ICU	DTCER137	—	—	—	—	—	—	—	DTCE
ICU	DTCER138	—	—	—	—	—	—	—	DTCE
ICU	DTCER139	—	—	—	—	—	—	—	DTCE
ICU	DTCER140	—	—	—	—	—	—	—	DTCE
ICU	DTCER141	—	—	—	—	—	—	—	DTCE
ICU	DTCER142	—	—	—	—	—	—	—	DTCE
ICU	DTCER143	—	—	—	—	—	—	—	DTCE
ICU	DTCER144	—	—	—	—	—	—	—	DTCE
ICU	DTCER145	—	—	—	—	—	—	—	DTCE
ICU	DTCER149	—	—	—	—	—	—	—	DTCE
ICU	DTCER150	—	—	—	—	—	—	—	DTCE
ICU	DTCER151	—	—	—	—	—	—	—	DTCE
ICU	DTCER152	—	—	—	—	—	—	—	DTCE
ICU	DTCER153	—	—	—	—	—	—	—	DTCE
ICU	DTCER174	—	—	—	—	—	—	—	DTCE
ICU	DTCER175	—	—	—	—	—	—	—	DTCE
ICU	DTCER176	—	—	—	—	—	—	—	DTCE
ICU	DTCER177	—	—	—	—	—	—	—	DTCE
ICU	DTCER178	—	—	—	—	—	—	—	DTCE
ICU	DTCER179	—	—	—	—	—	—	—	DTCE

Table 4.2 List of I/O Registers (Bit Order) (7 / 30)

Module Abbreviation	Register Abbreviation	Bit 31/23/15/7	Bit 30/22/14/6	Bit 29/21/13/5	Bit 28/20/12/4	Bit 27/19/11/3	Bit 26/18/10/2	Bit 25/17/9/1	Bit 24/16/8/0
ICU	DTCER180	—	—	—	—	—	—	—	DTCE
ICU	DTCER181	—	—	—	—	—	—	—	DTCE
ICU	DTCER182	—	—	—	—	—	—	—	DTCE
ICU	DTCER183	—	—	—	—	—	—	—	DTCE
ICU	DTCER184	—	—	—	—	—	—	—	DTCE
ICU	DTCER186	—	—	—	—	—	—	—	DTCE
ICU	DTCER187	—	—	—	—	—	—	—	DTCE
ICU	DTCER188	—	—	—	—	—	—	—	DTCE
ICU	DTCER189	—	—	—	—	—	—	—	DTCE
ICU	DTCER190	—	—	—	—	—	—	—	DTCE
ICU	DTCER192	—	—	—	—	—	—	—	DTCE
ICU	DTCER193	—	—	—	—	—	—	—	DTCE
ICU	DTCER194	—	—	—	—	—	—	—	DTCE
ICU	DTCER195	—	—	—	—	—	—	—	DTCE
ICU	DTCER196	—	—	—	—	—	—	—	DTCE
ICU	DTCER215	—	—	—	—	—	—	—	DTCE
ICU	DTCER216	—	—	—	—	—	—	—	DTCE
ICU	DTCER219	—	—	—	—	—	—	—	DTCE
ICU	DTCER220	—	—	—	—	—	—	—	DTCE
ICU	DTCER223	—	—	—	—	—	—	—	DTCE
ICU	DTCER224	—	—	—	—	—	—	—	DTCE
ICU	DTCER247	—	—	—	—	—	—	—	DTCE
ICU	DTCER248	—	—	—	—	—	—	—	DTCE
ICU	DTCER254	—	—	—	—	—	—	—	DTCE
ICU	IER02	IEN7	IEN6	IEN5	IEN4	IEN3	IEN2	IEN1	IEN0
ICU	IER03	IEN7	IEN6	IEN5	IEN4	IEN3	IEN2	IEN1	IEN0
ICU	IER05	IEN7	IEN6	IEN5	IEN4	IEN3	IEN2	IEN1	IEN0
ICU	IER07	IEN7	IEN6	IEN5	IEN4	IEN3	IEN2	IEN1	IEN0
ICU	IER08	IEN7	IEN6	IEN5	IEN4	IEN3	IEN2	IEN1	IEN0
ICU	IER0C	IEN7	IEN6	IEN5	IEN4	IEN3	IEN2	IEN1	IEN0
ICU	IER0D	IEN7	IEN6	IEN5	IEN4	IEN3	IEN2	IEN1	IEN0
ICU	IER0E	IEN7	IEN6	IEN5	IEN4	IEN3	IEN2	IEN1	IEN0
ICU	IER0F	IEN7	IEN6	IEN5	IEN4	IEN3	IEN2	IEN1	IEN0
ICU	IER10	IEN7	IEN6	IEN5	IEN4	IEN3	IEN2	IEN1	IEN0
ICU	IER11	IEN7	IEN6	IEN5	IEN4	IEN3	IEN2	IEN1	IEN0
ICU	IER12	IEN7	IEN6	IEN5	IEN4	IEN3	IEN2	IEN1	IEN0
ICU	IER13	IEN7	IEN6	IEN5	IEN4	IEN3	IEN2	IEN1	IEN0
ICU	IER15	IEN7	IEN6	IEN5	IEN4	IEN3	IEN2	IEN1	IEN0
ICU	IER16	IEN7	IEN6	IEN5	IEN4	IEN3	IEN2	IEN1	IEN0
ICU	IER17	IEN7	IEN6	IEN5	IEN4	IEN3	IEN2	IEN1	IEN0
ICU	IER18	IEN7	IEN6	IEN5	IEN4	IEN3	IEN2	IEN1	IEN0
ICU	IER1A	IEN7	IEN6	IEN5	IEN4	IEN3	IEN2	IEN1	IEN0
ICU	IER1B	IEN7	IEN6	IEN5	IEN4	IEN3	IEN2	IEN1	IEN0
ICU	IER1C	IEN7	IEN6	IEN5	IEN4	IEN3	IEN2	IEN1	IEN0
ICU	IER1E	IEN7	IEN6	IEN5	IEN4	IEN3	IEN2	IEN1	IEN0
ICU	IER1F	IEN7	IEN6	IEN5	IEN4	IEN3	IEN2	IEN1	IEN0
ICU	SWINTR	—	—	—	—	—	—	—	SWINT
ICU	FIR	FIEN	—	—	—	—	—	—	—
FVCT[7:0]									
ICU	IPR00	—	—	—	—	—	—	IPR[3:0]	—
ICU	IPR01	—	—	—	—	—	—	IPR[3:0]	—
ICU	IPR02	—	—	—	—	—	—	IPR[3:0]	—

**Table 4.2 List of I/O Registers (Bit Order) (8 / 30)**

Module Abbreviation	Register Abbreviation	Bit 31/23/15/7	Bit 30/22/14/6	Bit 29/21/13/5	Bit 28/20/12/4	Bit 27/19/11/3	Bit 26/18/10/2	Bit 25/17/9/1	Bit 24/16/8/0
ICU	IPR03	—	—	—	—			IPR[3:0]	
ICU	IPR04	—	—	—	—			IPR[3:0]	
ICU	IPR05	—	—	—	—			IPR[3:0]	
ICU	IPR06	—	—	—	—			IPR[3:0]	
ICU	IPR07	—	—	—	—			IPR[3:0]	
ICU	IPR14	—	—	—	—			IPR[3:0]	
ICU	IPR18	—	—	—	—			IPR[3:0]	
ICU	IPR20	—	—	—	—			IPR[3:0]	
ICU	IPR21	—	—	—	—			IPR[3:0]	
ICU	IPR22	—	—	—	—			IPR[3:0]	
ICU	IPR23	—	—	—	—			IPR[3:0]	
ICU	IPR24	—	—	—	—			IPR[3:0]	
ICU	IPR25	—	—	—	—			IPR[3:0]	
ICU	IPR26	—	—	—	—			IPR[3:0]	
ICU	IPR27	—	—	—	—			IPR[3:0]	
ICU	IPR40	—	—	—	—			IPR[3:0]	
ICU	IPR44	—	—	—	—			IPR[3:0]	
ICU	IPR48	—	—	—	—			IPR[3:0]	
ICU	IPR49	—	—	—	—			IPR[3:0]	
ICU	IPR51	—	—	—	—			IPR[3:0]	
ICU	IPR52	—	—	—	—			IPR[3:0]	
ICU	IPR53	—	—	—	—			IPR[3:0]	
ICU	IPR54	—	—	—	—			IPR[3:0]	
ICU	IPR55	—	—	—	—			IPR[3:0]	
ICU	IPR56	—	—	—	—			IPR[3:0]	
ICU	IPR57	—	—	—	—			IPR[3:0]	
ICU	IPR58	—	—	—	—			IPR[3:0]	
ICU	IPR59	—	—	—	—			IPR[3:0]	
ICU	IPR5A	—	—	—	—			IPR[3:0]	
ICU	IPR5B	—	—	—	—			IPR[3:0]	
ICU	IPR5C	—	—	—	—			IPR[3:0]	
ICU	IPR5D	—	—	—	—			IPR[3:0]	
ICU	IPR5E	—	—	—	—			IPR[3:0]	
ICU	IPR5F	—	—	—	—			IPR[3:0]	
ICU	IPR60	—	—	—	—			IPR[3:0]	
ICU	IPR67	—	—	—	—			IPR[3:0]	
ICU	IPR68	—	—	—	—			IPR[3:0]	
ICU	IPR69	—	—	—	—			IPR[3:0]	
ICU	IPR6A	—	—	—	—			IPR[3:0]	
ICU	IPR6B	—	—	—	—			IPR[3:0]	
ICU	IPR6C	—	—	—	—			IPR[3:0]	
ICU	IPR6D	—	—	—	—			IPR[3:0]	
ICU	IPR6E	—	—	—	—			IPR[3:0]	
ICU	IPR6F	—	—	—	—			IPR[3:0]	
ICU	IPR80	—	—	—	—			IPR[3:0]	
ICU	IPR81	—	—	—	—			IPR[3:0]	
ICU	IPR82	—	—	—	—			IPR[3:0]	
ICU	IPR88	—	—	—	—			IPR[3:0]	
ICU	IPR89	—	—	—	—			IPR[3:0]	
ICU	IPR8A	—	—	—	—			IPR[3:0]	
ICU	IPR8B	—	—	—	—			IPR[3:0]	
ICU	IPR90	—	—	—	—			IPR[3:0]	

**Table 4.2 List of I/O Registers (Bit Order) (9 / 30)**

Module Abbreviation	Register Abbreviation	Bit 31/23/15/7	Bit 30/22/14/6	Bit 29/21/13/5	Bit 28/20/12/4	Bit 27/19/11/3	Bit 26/18/10/2	Bit 25/17/9/1	Bit 24/16/8/0
ICU	IRQCR0	—	—	—	—	—	IRQMD[1:0]	—	—
ICU	IRQCR1	—	—	—	—	—	IRQMD[1:0]	—	—
ICU	IRQCR2	—	—	—	—	—	IRQMD[1:0]	—	—
ICU	IRQCR3	—	—	—	—	—	IRQMD[1:0]	—	—
ICU	IRQCR4	—	—	—	—	—	IRQMD[1:0]	—	—
ICU	IRQCR5	—	—	—	—	—	IRQMD[1:0]	—	—
ICU	IRQCR6	—	—	—	—	—	IRQMD[1:0]	—	—
ICU	IRQCR7	—	—	—	—	—	IRQMD[1:0]	—	—
ICU	NMISR	—	—	—	—	—	OSTST	LVDST	NMIST
ICU	NMIER	—	—	—	—	—	OSTEN	LVDEN	NMIEN
ICU	NMICLR	—	—	—	—	—	OSTCLR	—	NMICLR
ICU	NMICR	—	—	—	—	NMIMD	—	—	—
CMT	CMSTR0	—	—	—	—	—	—	—	—
		—	—	—	—	—	—	STR1	STR0
CMT0	CMCR	—	—	—	—	—	—	—	—
		—	CMIE	—	—	—	—	CKS[1:0]	—
CMT0	CMCNT	—	—	—	—	—	—	—	—
CMT0	CMCOR	—	—	—	—	—	—	—	—
CMT1	CMCR	—	—	—	—	—	—	—	—
		—	CMIE	—	—	—	—	CKS[1:0]	—
CMT1	CMCNT	—	—	—	—	—	—	—	—
CMT1	CMCOR	—	—	—	—	—	—	—	—
CMT	CMSTR1	—	—	—	—	—	—	—	—
		—	—	—	—	—	—	STR3	STR2
CMT2	CMCR	—	—	—	—	—	—	—	—
		—	CMIE	—	—	—	—	CKS[1:0]	—
CMT2	CMCNT	—	—	—	—	—	—	—	—
CMT2	CMCOR	—	—	—	—	—	—	—	—
CMT3	CMCR	—	—	—	—	—	—	—	—
		—	CMIE	—	—	—	—	CKS[1:0]	—
CMT3	CMCNT	—	—	—	—	—	—	—	—
CMT3	CMCOR	—	—	—	—	—	—	—	—
WDT	TCSR	—	TMS	TME	—	—	—	CKS[2:0]	—
WDT	WINA	—	—	—	—	—	—	—	—
WDT	TCNT	—	—	—	—	—	—	—	—
WDT	WINB	—	—	—	—	—	—	—	—
WDT	RSTCSR	WOVF	RSTE	—	—	—	—	—	—
IWDT	IWDTCR	—	—	—	—	—	—	—	—
		—	—	—	—	—	—	—	—
		—	—	—	—	—	—	—	—
		—	—	—	—	—	—	—	—
IWDT	IWDTSR	—	UNDF	—	—	—	—	—	—
		—	—	—	—	—	—	—	—
		—	—	—	—	—	—	—	—
		—	—	—	—	—	—	—	—
AD0	ADDR <sup>A1</sup>	—	—	—	—	—	—	—	—

Table 4.2 List of I/O Registers (Bit Order) (10 / 30)

Module Abbreviation	Register Abbreviation	Bit 31/23/15/7	Bit 30/22/14/6	Bit 29/21/13/5	Bit 28/20/12/4	Bit 27/19/11/3	Bit 26/18/10/2	Bit 25/17/9/1	Bit 24/16/8/0
AD0	ADDRB <sup>*1</sup>	—	—	—	—	—	—	—	—
AD0	ADDRC <sup>*1</sup>	—	—	—	—	—	—	—	—
AD0	ADDRD <sup>*1</sup>	—	—	—	—	—	—	—	—
AD0	ADDRE <sup>*1</sup>	—	—	—	—	—	—	—	—
AD0	ADDRF <sup>*1</sup>	—	—	—	—	—	—	—	—
AD0	ADDRG <sup>*1</sup>	—	—	—	—	—	—	—	—
AD0	ADDRH <sup>*1</sup>	—	—	—	—	—	—	—	—
AD0	ADCSR	—	ADIE	ADST	—	—	—	CH[3:0]	—
AD0	ADCR	—	—	—	—	—	CKS[1:0]	—	MODE[1:0]
AD0	ADSSTR	—	—	—	—	—	—	—	—
AD0	ADDIAGR	—	—	—	—	—	—	—	DIAG[1:0]
AD0	ADDRI <sup>*1</sup>	—	—	—	—	—	—	—	—
AD0	ADDRJ <sup>*1</sup>	—	—	—	—	—	—	—	—
AD0	ADDRK <sup>*1</sup>	—	—	—	—	—	—	—	—
AD0	ADDRL <sup>*1</sup>	—	—	—	—	—	—	—	—
AD0	ADSTRGR	—	—	—	—	—	ADSTRS[4:0]	—	—
AD0	ADDDR	DPSEL	—	—	—	—	—	—	DPPRC
SCI0	SMR	CM	CHR	PE	PM	STOP	MP	—	CKS[1:0]
SCI0	BRR	—	—	—	—	—	—	—	—
SCI0	SCR	TIE	RIE	TE	RE	MPIE	TEIE	—	CKE[1:0]
SCI0	TDR	—	—	—	—	—	—	—	—
SCI0	SSR	TDRE	RDRF	ORER	FER	PER	TEND	MPB	MPBT
SCI0	RDR	—	—	—	—	—	—	—	—
SCI0	SCMR	BCP2	—	—	—	SDIR	SINV	—	SMIF
SCI0	SEMR	—	—	NFEN	ABCS	—	—	—	—
SMCI0	SMR	GM	BLK	PE	PM	—	(BCP[1:0])	—	CKS[1:0]
SMCI0	BRR	—	—	—	—	—	—	—	—
SMCI0	SCR	TIE	RIE	TE	RE	MPIE	TEIE	—	CKE[1:0]
SMCI0	TDR	—	—	—	—	—	—	—	—
SMCI0	SSR	TDRE	RDRF	ORER	ERS	PER	TEND	MPB	MPBT
SMCI0	RDR	—	—	—	—	—	—	—	—
SMCI0	SCMR	BCP2	—	—	—	SDIR	SINV	—	SMIF
SCI1	SMR	CM	CHR	PE	PM	STOP	MP	—	CKS[1:0]
SCI1	BRR	—	—	—	—	—	—	—	—
SCI1	SCR	TIE	RIE	TE	RE	MPIE	TEIE	—	CKE[1:0]
SCI1	TDR	—	—	—	—	—	—	—	—
SCI1	SSR	TDRE	RDRF	ORER	FER	PER	TEND	MPB	MPBT
SCI1	RDR	—	—	—	—	—	—	—	—
SCI1	SCMR	BCP2	—	—	—	SDIR	SINV	—	SMIF

Table 4.2 List of I/O Registers (Bit Order) (11 / 30)

Module Abbreviation	Register Abbreviation	Bit 31/23/15/7	Bit 30/22/14/6	Bit 29/21/13/5	Bit 28/20/12/4	Bit 27/19/11/3	Bit 26/18/10/2	Bit 25/17/9/1	Bit 24/16/8/0
SCI1	SEMR	—	—	NFEN	ABCS	—	—	—	—
SMC11	SMR	GM	BLK	PE	PM	(BCP[1:0])		CKS[1:0]	
SMC11	BRR								
SMC11	SCR	TIE	RIE	TE	RE	MPIE	TEIE	CKE[1:0]	
SMC11	TDR								
SMC11	SSR	TDRE	RDRF	ORER	ERS	PER	TEND	MPB	MPBT
SMC11	RDR								
SMC11	SCMR	BCP2	—	—	—	SDIR	SINV	—	SMIF
SCI2	SMR	CM	CHR	PE	PM	STOP	MP	CKS[1:0]	
SCI2	BRR								
SCI2	SCR	TIE	RIE	TE	RE	MPIE	TEIE	CKE[1:0]	
SCI2	TDR								
SCI2	SSR	TDRE	RDRF	ORER	FER	PER	TEND	MPB	MPBT
SCI2	RDR								
SCI2	SCMR	BCP2	—	—	—	SDIR	SINV	—	SMIF
SMC12	SMR	GM	BLK	PE	PM	(BCP[1:0])		CKS[1:0]	
SMC12	BRR								
SMC12	SCR	TIE	RIE	TE	RE	MPIE	TEIE	CKE[1:0]	
SMC12	TDR								
SMC12	SSR	TDRE	RDRF	ORER	ERS	PER	TEND	MPB	MPBT
SMC12	RDR								
SMC12	SCMR	BCP2	—	—	—	SDIR	SINV	—	SMIF
CRC	CRCCR	DORCLR	—	—	—	—	LMS	GPS[1:0]	
CRC	CRCDIR								
CRC	CRCDOR								
RIIC0	ICCR1	ICE	IICRST	CLO	SOWP	SCLO	SDAO	SCLI	SDAI
RIIC0	ICCR2	BBSY	MST	TRS	—	SP	RS	ST	—
RIIC0	ICMR1	MTWP		CKS[2:0]		BCWP		BC[2:0]	
RIIC0	ICMR2	DLCS		SDDL[2:0]		TMWE	TMOH	TMOL	TMOS
RIIC0	ICMR3	SMBS	WAIT	RDRFS	ACKWP	ACKBT	ACKBR		NF[1:0]
RIIC0	ICFER	—	SCLE	NFE	NACKE	SALE	NALE	MALE	TMOE
RIIC0	ICSER	HOAE	—	DIDE	—	GCAE	SAR2E	SAR1E	SAR0E
RIIC0	ICIER	TIE	TEIE	RIE	NAKIE	SPIE	STIE	ALIE	TMOIE
RIIC0	ICSR1	HOA	—	DID	—	GCA	AAS2	AAS1	AAS0
RIIC0	ICSR2	TDRE	TEND	RDRF	NACKF	STOP	START	AL	TMOF
RIIC0	SARL0				SVA[6:0]				SVA0
RIIC0	TMOCNTL								
RIIC0	SARU0	—	—	—	—	—	SVA[1:0]		FS
RIIC0	TMOCNTU								
RIIC0	SARL1				SVA[6:0]				SVA0
RIIC0	SARU1	—	—	—	—	—	SVA[1:0]		FS
RIIC0	SARL2				SVA[6:0]				SVA0
RIIC0	SARU2	—	—	—	—	—	SVA[1:0]		FS
RIIC0	ICBRL	—	—	—			BRL[4:0]		
RIIC0	ICBRH	—	—	—			BRH[4:0]		
RIIC0	ICDRT								
RIIC0	ICDRR								
RSP10	SPCR	SPRIE	SPE	SPTIE	SPEIE	MSTR	MODFEN	TXMD	SPMS

Table 4.2 List of I/O Registers (Bit Order) (12 / 30)

Module Abbreviation	Register Abbreviation	Bit 31/23/15/7	Bit 30/22/14/6	Bit 29/21/13/5	Bit 28/20/12/4	Bit 27/19/11/3	Bit 26/18/10/2	Bit 25/17/9/1	Bit 24/16/8/0
RSPi0	SSLP	—	—	—	—	SSLP3	SSLP2	SSLP1	SSLP0
RSPi0	SPPCR	—	—	MOIFE	MOIFV	—	—	SPLP2	SPLP
RSPi0	SPSR	SPRF	—	SPTEF	—	PERF	MODF	IDLNF	OVRF
RSPi0	SPDR	H[15:0]							
		H[15:0]							
		L[15:0]							
		L[15:0]							
RSPi0	SPSCR	—	—	—	—	—	—	SPSLN[2:0]	—
RSPi0	SPSSR	—	—	SPECM[2:0]	—	—	—	SPCP[2:0]	—
RSPi0	SPBR	SPR7	SPR6	SPR5	SPR4	SPR3	SPR2	SPR1	SPR0
RSPi0	SPDCR	—	—	SPLW	SPRDTD	SLSEL[1:0]	—	SPFC[1:0]	—
RSPi0	SPCKD	—	—	—	—	—	—	SCKDL[2:0]	—
RSPi0	SSLND	—	—	—	—	—	—	SLNDL[2:0]	—
RSPi0	SPND	—	—	—	—	—	—	SPNDL[2:0]	—
RSPi0	SPCR2	—	—	—	—	PTE	SPIIE	SPOE	SPPE
RSPi0	SPCMD0	SCKDEN	SLNDEN	SPNDEN	LSBF	—	—	SPB[3:0]	—
		SSLKP	—	SSLA[2:0]	—	BRDV[1:0]	—	CPOL	CPHA
RSPi0	SPCMD1	SCKDEN	SLNDEN	SPNDEN	LSBF	—	—	SPB[3:0]	—
		SSLKP	—	SSLA[2:0]	—	BRDV[1:0]	—	CPOL	CPHA
RSPi0	SPCMD2	SCKDEN	SLNDEN	SPNDEN	LSBF	—	—	SPB[3:0]	—
		SSLKP	—	SSLA[2:0]	—	BRDV[1:0]	—	CPOL	CPHA
RSPi0	SPCMD3	SCKDEN	SLNDEN	SPNDEN	LSBF	—	—	SPB[3:0]	—
		SSLKP	—	SSLA[2:0]	—	BRDV[1:0]	—	CPOL	CPHA
RSPi0	SPCMD4	SCKDEN	SLNDEN	SPNDEN	LSBF	—	—	SPB[3:0]	—
		SSLKP	—	SSLA[2:0]	—	BRDV[1:0]	—	CPOL	CPHA
RSPi0	SPCMD5	SCKDEN	SLNDEN	SPNDEN	LSBF	—	—	SPB[3:0]	—
		SSLKP	—	SSLA[2:0]	—	BRDV[1:0]	—	CPOL	CPHA
RSPi0	SPCMD6	SCKDEN	SLNDEN	SPNDEN	LSBF	—	—	SPB[3:0]	—
		SSLKP	—	SSLA[2:0]	—	BRDV[1:0]	—	CPOL	CPHA
RSPi0	SPCMD7	SCKDEN	SLNDEN	SPNDEN	LSBF	—	—	SPB[3:0]	—
		SSLKP	—	SSLA[2:0]	—	BRDV[1:0]	—	CPOL	CPHA
S12AD0	ADCSR	ADST	ADCS[1:0]	—	ADIE	—	CKS[1:0]	TRGE	EXTRG
S12AD0	ADANS	—	—	CH[1:0]	—	—	PG002SEL	PG001SEL	PG000SEL
		—	—	—	—	—	PG002EN	PG001EN	PG000EN
S12AD0	ADPG	—	—	—	—	—	PG002GAIN[3:0]	PG001GAIN[3:0]	PG000GAIN[3:0]
		—	—	—	—	—	PG002GAIN[3:0]	PG001GAIN[3:0]	PG000GAIN[3:0]
S12AD0	ADCER	ADRFMT	—	ADIEW	ADIE2	DIAGM	DIAGLD	DIAGVAL[1:0]	—
		—	—	ACE	—	—	ADPRC[1:0]	—	SHBYP
S12AD0	ADSTRGR	—	—	—	—	—	ADSTRS1[4:0]	—	—
		—	—	—	—	—	ADSTRS0[4:0]	—	—
S12AD	ADCMPMD0	—	—	CEN102[1:0]	—	CEN101[1:0]	—	CEN100[1:0]	—
		—	—	CEN002[1:0]	—	CEN001[1:0]	—	CEN000[1:0]	—
S12AD	ADCMPMD1	—	VSELL1	VSELH1	CSEL1	—	VSELL0	VSELH0	CSEL0
		—	—	REFH[2:0]	—	—	—	REFL[2:0]	—
S12AD	ADCMPNR0	—	—	—	—	—	C002NR[3:0]	—	—
		—	—	C001NR[3:0]	—	—	C000NR[3:0]	—	—
S12AD	ADCMPNR1	—	—	—	—	—	C102NR[3:0]	—	—
		—	—	C101NR[3:0]	—	—	C100NR[3:0]	—	—
S12AD	ADCMPFR	—	—	C102FLAG	C101FLAG	C100FLAG	C002FLAG	C001FLAG	C000FLAG
S12AD	ADCMPSEL	—	—	—	—	—	—	POERQ	IE
		—	—	SEL102	SEL101	SEL100	SEL002	SEL001	SEL000

Table 4.2 List of I/O Registers (Bit Order) (13 / 30)

Module Abbreviation	Register Abbreviation	Bit 31/23/15/7	Bit 30/22/14/6	Bit 29/21/13/5	Bit 28/20/12/4	Bit 27/19/11/3	Bit 26/18/10/2	Bit 25/17/9/1	Bit 24/16/8/0
S12AD0	ADDR <sup>2</sup>	DIAGST[1:0]		—	—	AD11	AD10	AD9	AD8
		AD7	AD6	AD5	AD4	AD3	AD2	AD1	AD0
S12AD0	ADDR0A <sup>2</sup>	—	—	—	—	AD11	AD10	AD9	AD8
		AD7	AD6	AD5	AD4	AD3	AD2	AD1	AD0
S12AD0	ADDR1 <sup>2</sup>	—	—	—	—	AD11	AD10	AD9	AD8
		AD7	AD6	AD5	AD4	AD3	AD2	AD1	AD0
S12AD0	ADDR2 <sup>2</sup>	—	—	—	—	AD11	AD10	AD9	AD8
		AD7	AD6	AD5	AD4	AD3	AD2	AD1	AD0
S12AD0	ADDR3 <sup>2</sup>	—	—	—	—	AD11	AD10	AD9	AD8
		AD7	AD6	AD5	AD4	AD3	AD2	AD1	AD0
S12AD0	ADDR0B <sup>2</sup>	—	—	—	—	AD11	AD10	AD9	AD8
		AD7	AD6	AD5	AD4	AD3	AD2	AD1	AD0
S12AD0	ADSSTR								
S12AD1	ADCSR	ADST	ADCS[1:0]		ADIE	CKS[1:0]		TRGE	EXTRG
S12AD1	ADANS	—	—	CH[1:0]		—	PG102SEL	PG101SEL	PG100SEL
		—	—	—	—	—	PG102EN	PG101EN	PG100EN
S12AD1	ADPG	—	—	—	—	PG102GAIN[3:0]			
		PG101GAIN[3:0]			PG100GAIN[3:0]				
S12AD1	ADCER	ADRFMT	—	ADIEW	ADIE2	DIAGM	DIAGLD	DIAGVAL[1:0]	
		—	—	ACE	—	—	ADPRC[1:0]		SHBYP
S12AD1	ADSTRGR	—	—	—	ADSTRS1[4:0]				
		—	—	—	ADSTRS0[4:0]				
S12AD1	ADDR <sup>2</sup>	DIAGST[1:0]		—	—	AD11	AD10	AD9	AD8
		AD7	AD6	AD5	AD4	AD3	AD2	AD1	AD0
S12AD1	ADDR0A <sup>2</sup>	—	—	—	—	AD11	AD10	AD9	AD8
		AD7	AD6	AD5	AD4	AD3	AD2	AD1	AD0
S12AD1	ADDR1 <sup>2</sup>	—	—	—	—	AD11	AD10	AD9	AD8
		AD7	AD6	AD5	AD4	AD3	AD2	AD1	AD0
S12AD1	ADDR2 <sup>2</sup>	—	—	—	—	AD11	AD10	AD9	AD8
		AD7	AD6	AD5	AD4	AD3	AD2	AD1	AD0
S12AD1	ADDR3 <sup>2</sup>	—	—	—	—	AD11	AD10	AD9	AD8
		AD7	AD6	AD5	AD4	AD3	AD2	AD1	AD0
S12AD1	ADDR0B <sup>2</sup>	—	—	—	—	AD11	AD10	AD9	AD8
		AD7	AD6	AD5	AD4	AD3	AD2	AD1	AD0
S12AD1	ADSSTR								
PORT1	DDR	—	—	—	—	—	—	B1	B0
PORT2	DDR	—	—	—	B4	B3	B2	B1	B0
PORT3	DDR	—	—	—	—	B3	B2	B1	B0
PORT7	DDR	—	B6	B5	B4	B3	B2	B1	B0
PORT8	DDR	—	—	—	—	—	B2	B1	B0
PORT9	DDR	—	B6	B5	B4	B3	B2	B1	B0
PORTA	DDR	—	—	B5	B4	B3	B2	B1	B0
PORTB	DDR	B7	B6	B5	B4	B3	B2	B1	B0
PORTD	DDR	B7	B6	B5	B4	B3	B2	B1	B0
PORTE	DDR	—	—	B5	B4	B3	—	B1	B0
PORTG	DDR	—	—	B5	B4	B3	B2	B1	B0
PORT1	DR	—	—	—	—	—	—	B1	B0
PORT2	DR	—	—	—	B4	B3	B2	B1	B0
PORT3	DR	—	—	—	—	B3	B2	B1	B0
PORT7	DR	—	B6	B5	B4	B3	B2	B1	B0



**Table 4.2 List of I/O Registers (Bit Order) (14 / 30)**

Module Abbreviation	Register Abbreviation	Bit 31/23/15/7	Bit 30/22/14/6	Bit 29/21/13/5	Bit 28/20/12/4	Bit 27/19/11/3	Bit 26/18/10/2	Bit 25/17/9/1	Bit 24/16/8/0
PORT8	DR	—	—	—	—	—	B2	B1	B0
PORT9	DR	—	B6	B5	B4	B3	B2	B1	B0
PORTA	DR	—	—	B5	B4	B3	B2	B1	B0
PORTB	DR	B7	B6	B5	B4	B3	B2	B1	B0
PORTD	DR	B7	B6	B5	B4	B3	B2	B1	B0
PORTE	DR	—	—	B5	B4	B3	—	B1	B0
PORTG	DR	—	—	B5	B4	B3	B2	B1	B0
PORT1	PORT	—	—	—	—	—	—	B1	B0
PORT2	PORT	—	—	—	B4	B3	B2	B1	B0
PORT3	PORT	—	—	—	—	B3	B2	B1	B0
PORT4	PORT	B7	B6	B5	B4	B3	B2	B1	B0
PORT5	PORT	—	—	B5	B4	B3	B2	B1	B0
PORT6	PORT	—	—	B5	B4	B3	B2	B1	B0
PORT7	PORT	—	B6	B5	B4	B3	B2	B1	B0
PORT8	PORT	—	—	—	—	—	B2	B1	B0
PORT9	PORT	—	B6	B5	B4	B3	B2	B1	B0
PORTA	PORT	—	—	B5	B4	B3	B2	B1	B0
PORTB	PORT	B7	B6	B5	B4	B3	B2	B1	B0
PORTD	PORT	B7	B6	B5	B4	B3	B2	B1	B0
PORTE	PORT	—	—	B5	B4	B3	B2	B1	B0
PORTG	PORT	—	—	B5	B4	B3	B2	B1	B0
PORT1	ICR	—	—	—	—	—	—	B1	B0
PORT2	ICR	—	—	—	B4	B3	B2	B1	B0
PORT3	ICR	—	—	—	—	B3	B2	B1	B0
PORT4	ICR	B7	B6	B5	B4	B3	B2	B1	B0
PORT5	ICR	—	—	B5	B4	B3	B2	B1	B0
PORT6	ICR	—	—	B5	B4	B3	B2	B1	B0
PORT7	ICR	—	B6	B5	B4	B3	B2	B1	B0
PORT8	ICR	—	—	—	—	—	B2	B1	B0
PORT9	ICR	—	B6	B5	B4	B3	B2	B1	B0
PORTA	ICR	—	—	B5	B4	B3	B2	B1	B0
PORTB	ICR	B7	B6	B5	B4	B3	B2	B1	B0
PORTD	ICR	B7	B6	B5	B4	B3	B2	B1	B0
PORTE	ICR	—	—	B5	B4	B3	—	B1	B0
PORTG	ICR	—	—	B5	B4	B3	B2	B1	B0
IOPORT	PF8IRQ	—	—	—	—	ITS1[1:0]		ITS0[1:0]	
IOPORT	PF9IRQ	—	—	—	—	—	ITS2	—	—
IOPORT	PFAADC	—	—	—	—	—	—	ADTRG1S	ADTRG0S
IOPORT	PFCMTU	TCLKS[1:0]		—	—	—	—	MTUS1	MTUS0
IOPORT	PFDGPT	—	—	—	—	—	—	—	GPTS
IOPORT	PFSCI	—	—	—	—	—	SCI2S	—	—
IOPORT	PFGSPI	SSL3E	SSL2E	SSL1E	SSL0E	MISOE	MOSIE	RSPCKE	—
IOPORT	PFHSPI	—	—	—	—	—	—	RSPIS[1:0]	
IOPORT	PFJCAN	CANS[1:0]		—	—	—	—	—	CANE
IOPORT	PFKLIN	—	—	—	—	—	—	—	LINE
IOPORT	PFMPOE	—	—	—	POE11E	POE10E	POE8E	POE4E	POE0E
IOPORT	PFNPOE	POE10S	—	—	—	—	—	—	—
SYSTEM	DPSBYCR	DPSBY	IOKEEP	—	—	—	—	—	—
SYSTEM	DPSWCR	—	—	—	—	WTSTS[5:0]			
SYSTEM	DPSIER	DNMIE	—	—	DLVDE	—	—	DIRQ1E	DIRQ0E

**Table 4.2 List of I/O Registers (Bit Order) (15 / 30)**

Module Abbreviation	Register Abbreviation	Bit 31/23/15/7	Bit 30/22/14/6	Bit 29/21/13/5	Bit 28/20/12/4	Bit 27/19/11/3	Bit 26/18/10/2	Bit 25/17/9/1	Bit 24/16/8/0
SYSTEM	DPSIFR	DNMIF	—	—	DLVDF	—	—	DIRQ1F	DIRQ0F
SYSTEM	DPSIEGR	DNMIEG	—	—	—	—	—	DIRQ1EG	DIRQ0EG
SYSTEM	RSTSR	DPSRSTF	—	—	—	—	LVD2F	LVD1F	PORF
FLASH	FWEPROR	—	—	—	—	—	—	FLWE[1:0]	
SYSTEM	LVDKEYR					KEY[7:0]			
SYSTEM	LVD2CR	LVD2E	LVD2RI	—	—	LVD1E	LVD1RI	—	—
SYSTEM	DPSBKR0								
SYSTEM	DPSBKR1								
SYSTEM	DPSBKR2								
SYSTEM	DPSBKR3								
SYSTEM	DPSBKR4								
SYSTEM	DPSBKR5								
SYSTEM	DPSBKR6								
SYSTEM	DPSBKR7								
SYSTEM	DPSBKR8								
SYSTEM	DPSBKR9								
SYSTEM	DPSBKR10								
SYSTEM	DPSBKR11								
SYSTEM	DPSBKR12								
SYSTEM	DPSBKR13								
SYSTEM	DPSBKR14								
SYSTEM	DPSBKR15								
SYSTEM	DPSBKR16								
SYSTEM	DPSBKR17								
SYSTEM	DPSBKR18								
SYSTEM	DPSBKR19								
SYSTEM	DPSBKR20								
SYSTEM	DPSBKR21								
SYSTEM	DPSBKR22								
SYSTEM	DPSBKR23								
SYSTEM	DPSBKR24								
SYSTEM	DPSBKR25								
SYSTEM	DPSBKR26								
SYSTEM	DPSBKR27								
SYSTEM	DPSBKR28								
SYSTEM	DPSBKR29								
SYSTEM	DPSBKR30								
SYSTEM	DPSBKR31								
POE	ICSR1	—	—	—	POE0F	—	—	—	PIE1
		—	—	—	—	—	—	POE0M[1:0]	
POE	OCSR1	OSF1	—	—	—	—	—	OCE1	OIE1
		—	—	—	—	—	—	—	—
POE	ICSR2	—	—	—	POE4F	—	—	—	PIE2
		—	—	—	—	—	—	POE4M[1:0]	
POE	OCSR2	OSF2	—	—	—	—	—	OCE2	OIE2
		—	—	—	—	—	—	—	—
POE	ICSR3	—	—	—	POE8F	—	—	POE8E	PIE3
		—	—	—	—	—	—	POE8M[1:0]	
POE	SPOER	—	—	—	GPT23HIZ	GPT01HIZ	MTUCH0HIZ	MTUCH67HIZ	MTUCH34HIZ
POE	POECR1	—	—	—	—	MTU0DZE	MTU0CZE	MTU0BZE	MTU0AZE

Table 4.2 List of I/O Registers (Bit Order) (16 / 30)

Module Abbreviation	Register Abbreviation	Bit 31/23/15/7	Bit 30/22/14/6	Bit 29/21/13/5	Bit 28/20/12/4	Bit 27/19/11/3	Bit 26/18/10/2	Bit 25/17/9/1	Bit 24/16/8/0	
POE	POECR2	—	—	—	—	—	MTU3BDZE	MTU4ACZE	MTU4BDZE	
		—	—	—	—	—	MTU6BDZE	MTU7ACZE	MTU7BDZE	
POE	POECR3	—	—	—	—	—	—	GPT3ABZE	GPT2ABZE	
		—	—	—	—	—	—	GPT1ABZE	GPT0ABZE	
POE	POECR4	—	—	IC5ADDMT67ZE	IC4ADDMT67ZE	IC3ADDMT67ZE	—	IC1ADDMT67ZE	CMADDMT67ZE	
		—	—	IC5ADDMT34ZE	IC4ADDMT34ZE	IC3ADDMT34ZE	IC2ADDMT34ZE	—	CMADDMT34ZE	
POE	POECR5	—	—	—	—	—	—	—	—	
		—	—	IC5ADDMT0ZE	IC4ADDMT0ZE	—	IC2ADDMT0ZE	IC1ADDMT0ZE	CMADDMT0ZE	
POE	POECR6	—	—	—	IC4ADDGPT23ZE	IC3ADDGPT23ZE	IC2ADDGPT23ZE	IC1ADDGPT23ZE	CMADDGPT23ZE	
		—	—	IC5ADDGPT01ZE	—	IC3ADDGPT01ZE	IC2ADDGPT01ZE	IC1ADDGPT01ZE	CMADDGPT01ZE	
POE	ICSR4	—	—	—	POE10F	—	—	POE10E	PIE4	
		—	—	—	—	—	—	POE10M[1:0]	—	
POE	ALR1	—	—	—	—	—	—	—	—	
		OLSEN	—	OLSG2B	OLSG2A	OLSG1B	OLSG1A	OLSG0B	OLSG0A	
POE	ICSR5	—	—	—	POE11F	—	—	POE11E	PIE5	
		—	—	—	—	—	—	POE11M[1:0]	—	
CAN0*3	MB.ID	IDE	RTR	—	—	—	SID[10:0]	—	—	
		—	—	—	—	—	—	EID[17:0]	—	
		—	—	—	—	—	—	—	EID[17:0]	—
		—	—	—	—	—	—	—	—	—
		—	—	—	—	—	—	—	—	DLC[3:0]
		—	—	—	—	—	—	—	—	—
CAN0*3	MB.DLC	—	—	—	—	—	—	—	—	
		—	—	—	—	—	—	—	—	
		—	—	—	—	—	—	—	—	
		—	—	—	—	—	—	—	—	
		—	—	—	—	—	—	—	—	
		—	—	—	—	—	—	—	—	
CAN0*3	MB.DATA 0 to 7	—	—	—	—	—	—	—	—	
		—	—	—	—	—	—	—	—	
		—	—	—	—	—	—	—	—	
		—	—	—	—	—	—	—	—	
		—	—	—	—	—	—	—	—	
		—	—	—	—	—	—	—	—	
CAN0*3	MB.TS	—	—	—	—	—	—	—	—	
		—	—	—	—	—	—	—	—	
		—	—	—	—	—	—	—	—	
		—	—	—	—	—	—	—	—	
		—	—	—	—	—	—	—	—	
		—	—	—	—	—	—	—	—	
CAN0*3	MKR0	—	—	—	—	—	SID[10:0]	—	—	
		—	—	—	—	—	—	—	EID[17:0]	
		—	—	—	—	—	—	—	EID[17:0]	
		—	—	—	—	—	—	—	—	
		—	—	—	—	—	—	—	—	
		—	—	—	—	—	—	—	—	
CAN0*3	MKR1	—	—	—	—	—	SID[10:0]	—	—	
		—	—	—	—	—	—	—	EID[17:0]	
		—	—	—	—	—	—	—	EID[17:0]	
		—	—	—	—	—	—	—	—	
		—	—	—	—	—	—	—	—	
		—	—	—	—	—	—	—	—	
CAN0*3	MKR2	—	—	—	—	—	SID[10:0]	—	—	
		—	—	—	—	—	—	—	EID[17:0]	
		—	—	—	—	—	—	—	EID[17:0]	
		—	—	—	—	—	—	—	—	
		—	—	—	—	—	—	—	—	
		—	—	—	—	—	—	—	—	
CAN0*3	MKR3	—	—	—	—	—	SID[10:0]	—	—	
		—	—	—	—	—	—	—	EID[17:0]	
		—	—	—	—	—	—	—	EID[17:0]	
		—	—	—	—	—	—	—	—	
		—	—	—	—	—	—	—	—	
		—	—	—	—	—	—	—	—	
CAN0*3	MKR4	—	—	—	—	—	SID[10:0]	—	—	
		—	—	—	—	—	—	—	EID[17:0]	
		—	—	—	—	—	—	—	EID[17:0]	
		—	—	—	—	—	—	—	—	
		—	—	—	—	—	—	—	—	
		—	—	—	—	—	—	—	—	

**Table 4.2 List of I/O Registers (Bit Order) (17 / 30)**

Module Abbreviation	Register Abbreviation	Bit 31/23/15/7	Bit 30/22/14/6	Bit 29/21/13/5	Bit 28/20/12/4	Bit 27/19/11/3	Bit 26/18/10/2	Bit 25/17/9/1	Bit 24/16/8/0
CAN0*3	MKR5	—	—	—			SID[10:0]		
					SID[10:0]			EID[17:0]	
							EID[17:0]		
							EID[17:0]		
CAN0*3	MKR6	—	—	—			SID[10:0]		
					SID[10:0]			EID[17:0]	
							EID[17:0]		
							EID[17:0]		
CAN0*3	MKR7	—	—	—			SID[10:0]		
					SID[10:0]			EID[17:0]	
							EID[17:0]		
							EID[17:0]		
CAN0*3	FIDCR0	IDE	RTR	—			SID[10:0]		
					SID[10:0]			EID[17:0]	
							EID[17:0]		
							EID[17:0]		
CAN0*3	FIDCR1	IDE	RTR	—			SID[10:0]		
					SID[10:0]			EID[17:0]	
							EID[17:0]		
							EID[17:0]		
CAN0*3	MKIVLR								
CAN0*3	MIER	—	—	—	—	—	—	—	—
		—	—	—	—	—	—	—	—
		—	—	—	—	—	—	—	—
		—	—	—	—	—	—	—	—
CAN0*3	MCTL.TX	TRMREQ	RECREQ	—	ONESHOT	—	TRMABT	TRMACTIVE	SENTDATA
	MCTL.RX	TRMREQ	RECREQ	—	ONESHOT	—	MSGLOST	INVALIDDATA	NEWDATA
CAN0*3	CTLR	—	—	RBOC	BOM[1:0]	—	SLPM	CANM[1:0]	
			TSPS[1:0]	TSRC	TPM	MLM	IDFM[1:0]		MBM
CAN0*3	STR	—	RECST	TRMST	BOST	EPST	SLPST	HLTST	RSTST
		EST	TABST	FMLST	NMLST	TFST	RFST	SDST	NDST
CAN0*3	BCR			TSEG1[3:0]		—	—	BRP[9:0]	
								BRP[9:0]	
		—	—		SJW[1:0]	—		TSEG2[2:0]	
		—	—	—	—	—	—	—	—
CAN0*3	RFCR	RFEST	RFWST	RFFST	RFMLF		RFUST[2:0]	RFE	
CAN0*3	RFPCR	—	—	—	—	—	—	—	
CAN0*3	TFCR	TFEST	TFST	—	—		TFUST[2:0]	TFE	
CAN0*3	TFPCR	—	—	—	—	—	—	—	
CAN0*3	EIER	BLIE	OLIE	ORIE	BORIE	BOEIE	EPIE	EWIE	BEIE
CAN0*3	EIFR	BLIF	OLIF	ORIF	BORIF	BOEIF	EPIF	EWIF	BEIF
CAN0*3	RECR	—	—	—	—	—	—	—	—
CAN0*3	TECR	—	—	—	—	—	—	—	—
CAN0*3	ECSR	EDPM	ADEF	BE0F	BE1F	CEF	AEF	FEF	SEF
CAN0*3	CSSR	—	—	—	—	—	—	—	—
CAN0*3	MSSR	SEST	—	—			MBNST[4:0]		
CAN0*3	MSMR	—	—	—	—	—	—	MBSM[1:0]	
CAN0*3	TSR	—	—	—	—	—	—	—	—
		—	—	—	—	—	—	—	—

Table 4.2 List of I/O Registers (Bit Order) (18 / 30)

Module Abbreviation	Register Abbreviation	Bit 31/23/15/7	Bit 30/22/14/6	Bit 29/21/13/5	Bit 28/20/12/4	Bit 27/19/11/3	Bit 26/18/10/2	Bit 25/17/9/1	Bit 24/16/8/0
CAN0*3	AFSR	—	—	—	—	—	—	—	—
CAN0*3	TCR	—	—	—	—	—	TSTM[1:0]	—	TSTE
LINO	LWBR	—	—	—	—	—	—	—	LWBR0
LINO	LBRP0	—	—	—	—	—	—	—	—
LINO	LBRP1	—	—	—	—	—	—	—	—
LINO	LSTC	—	—	—	—	—	—	—	LSTM
LINO	LOMD	—	—	—	—	LCKS[1:0]	—	—	—
LINO	LOBRK	—	—	BDT[1:0]	—	—	BLT[3:0]	—	—
LINO	LOSPC	—	—	IBS[1:0]	—	—	IBSH[2:0]	—	—
LINO	LOWUP	—	WUTL[3:0]	—	—	—	—	—	—
LINO	LOIE	—	—	—	—	—	ERRIE	FRCIE	FTCIE
LINO	LOEDE	—	—	—	—	FERE	FTERE	PBERE	BERE
LINO	LOC	—	—	—	—	—	—	OM1	OM0
LINO	LOTC	—	—	—	—	—	—	RTS	FTS
LINO	LOMST	—	—	—	—	—	—	OMM1	OMM0
LINO	LOST	HTRC	D1RC	—	—	ERR	—	FRC	FTC
LINO	LOEST	—	—	CSER	—	FER	FTER	PBER	BER
LINO	LORFC	—	FSM	CSM	RFT	—	—	RFDL[3:0]	—
LINO	LOIDB	—	IDP	—	—	—	ID	—	—
LINO	LOCBR	—	—	—	—	—	—	—	—
LINO	LODB1	—	—	—	—	—	—	—	—
LINO	LODB2	—	—	—	—	—	—	—	—
LINO	LODB3	—	—	—	—	—	—	—	—
LINO	LODB4	—	—	—	—	—	—	—	—
LINO	LODB5	—	—	—	—	—	—	—	—
LINO	LODB6	—	—	—	—	—	—	—	—
LINO	LODB7	—	—	—	—	—	—	—	—
LINO	LODB8	—	—	—	—	—	—	—	—
MTU3	TCR	—	CCLR[2:0]	—	—	CKEG[1:0]	—	TPSC[2:0]	—
MTU4	TCR	—	CCLR[2:0]	—	—	CKEG[1:0]	—	TPSC[2:0]	—
MTU3	TMDR1	—	—	BFB	BFA	—	—	MD[3:0]	—
MTU4	TMDR1	—	—	BFB	BFA	—	—	MD[3:0]	—
MTU3	TIORH	—	—	IOB[3:0]	—	—	—	IOA[3:0]	—
MTU3	TIORL	—	—	IOD[3:0]	—	—	—	IOC[3:0]	—
MTU4	TIORH	—	—	IOB[3:0]	—	—	—	IOA[3:0]	—
MTU4	TIORL	—	—	IOD[3:0]	—	—	—	IOC[3:0]	—
MTU3	TIER	TTGE	—	—	TCIEV	TGIED	TGIEC	TGIEB	TGIEA
MTU4	TIER	TTGE	TTGE2	—	TCIEV	TGIED	TGIEC	TGIEB	TGIEA
MTU	TOERA	—	—	OE4D	OE4C	OE3D	OE4B	OE4A	OE3B
MTU	TGCRA	—	BDC	N	P	FB	WF	VF	UF
MTU	TOCR1A	—	PSYE	—	—	TOCL	TOCS	OLSN	OLSP
MTU	TOCR2A	—	BF[1:0]	OLS3N	OLS3P	OLS2N	OLS2P	OLS1N	OLS1P
MTU3	TCNT	—	—	—	—	—	—	—	—
MTU4	TCNT	—	—	—	—	—	—	—	—
MTU	TCDRA	—	—	—	—	—	—	—	—
MTU	TDDRA	—	—	—	—	—	—	—	—

**Table 4.2 List of I/O Registers (Bit Order) (19 / 30)**

Module Abbreviation	Register Abbreviation	Bit 31/23/15/7	Bit 30/22/14/6	Bit 29/21/13/5	Bit 28/20/12/4	Bit 27/19/11/3	Bit 26/18/10/2	Bit 25/17/9/1	Bit 24/16/8/0
MTU3	TGRA								
MTU3	TGRB								
MTU4	TGRA								
MTU4	TGRB								
MTU	TCNTSA								
MTU	TCBRA								
MTU3	TGRC								
MTU3	TGRD								
MTU4	TGRC								
MTU4	TGRD								
MTU3	TSR	TCFD	—	—	TCFV	TGFD	TGFC	TGFB	TGFA
MTU4	TSR	TCFD	—	—	TCFV	TGFD	TGFC	TGFB	TGFA
MTU	TITCR1A	T3AEN		T3ACOR[2:0]		T4VEN		T4VCOR[2:0]	
MTU	TBTERA	—		T3ACOR[2:0]		—		T4VCNT[2:0]	
MTU	TBTERA	—	—	—	—	—	—	BTE[1:0]	
MTU	TDERA	—	—	—	—	—	—	—	TDER
MTU	TOLBRA	—	—	OLS3N	OLS3P	OLS2N	OLS2P	OLS1N	OLS1P
MTU3	TBTM	—	—	—	—	—	—	TTSB	TTSA
MTU4	TBTM	—	—	—	—	—	—	TTSB	TTSA
MTU	TITMRA	—	—	—	—	—	—	—	TITM
MTU	TITCR2A	—	—	—	—	—	—	TRG4COR[2:0]	
MTU	TITCNT2A	—	—	—	—	—	—	TRG4COR[2:0]	
MTU4	TADCR		BF[1:0]	—	—	—	—	—	—
		UT4AE	DT4AE	UT4BE	DT4BE	ITA3AE	ITA4VE	ITB3AE	ITB4VE
MTU4	TADCORA								
MTU4	TADCORB								
MTU4	TADCOBRA								
MTU4	TADCOBRB								
MTU	TWCRA	CCE	—	—	—	—	—	—	WRE
MTU	TMDR2A	—	—	—	—	—	—	—	DRS
MTU3	TGRE								
MTU4	TGRE								
MTU4	TGRF								
MTU	TSTRA	CST4	CST3	—	—	—	CST2	CST1	CST0
MTU	TSYRA	SYNC4	SYNC3	—	—	—	SYNC2	SYNC1	SYNC0
MTU	TCSYSTR	SCH0	SCH1	SCH2	SCH3	SCH4	—	SCH6	SCH7
MTU	TRWERA	—	—	—	—	—	—	—	RWE
MTU0	TCR		CCLR[2:0]			CKEG[1:0]		TPSC[2:0]	

**Table 4.2 List of I/O Registers (Bit Order) (20 / 30)**

Module Abbreviation	Register Abbreviation	Bit 31/23/15/7	Bit 30/22/14/6	Bit 29/21/13/5	Bit 28/20/12/4	Bit 27/19/11/3	Bit 26/18/10/2	Bit 25/17/9/1	Bit 24/16/8/0
MTU0	TMDR1	—	BFE	BFB	BFA			MD[3:0]	
MTU0	TIORH			IOB[3:0]				IOA[3:0]	
MTU0	TIORL			IOD[3:0]				IOC[3:0]	
MTU0	TIER	TTEG	—	—	TCIEV	TGIED	TGIEC	TGIEB	TGIEA
MTU0	TSR	—	—	—	TCFV	TGFD	TGFC	TGFB	TGFA
MTU0	TCNT								
MTU0	TGRA								
MTU0	TGRB								
MTU0	TGRC								
MTU0	TGRD								
MTU0	TGRE								
MTU0	TGRF								
MTU0	TIER2	TTGE2	—	—	—	—	—	TGIEF	TGIEE
MTU0	TSR2	—	—	—	—	—	—	TGFF	TGFE
MTU0	TBTM	—	—	—	—	—	TTSE	TTSB	TTSA
MTU1	TCR	—	CCLR[1:0]		CKEG[1:0]			TPSC[2:0]	
MTU1	TMDR1	—	—	—	—			MD[3:0]	
MTU1	TIOR			IOB[3:0]				IOA[3:0]	
MTU1	TIER	TTEG	—	TCIEU	TCIEV	—	—	TGIEB	TGIEA
MTU1	TSR	TCFD	—	TCFU	TCFV	—	—	TGFB	TGFA
MTU1	TCNT								
MTU1	TGRA								
MTU1	TGRB								
MTU1	TICCR	—	—	—	—	I2BE	I2AE	I1BE	I1AE
MTU2	TCR	—	CCLR[1:0]		CKEG[1:0]			TPSC[2:0]	
MTU2	TMDR1	—	—	—	—			MD[3:0]	
MTU2	TIOR			IOB[3:0]				IOA[3:0]	
MTU2	TIER	TTGE	—	TCIEU	TCIEV	—	—	TGIEB	TGIEA
MTU2	TSR	TCFD	—	TCFU	TCFV	—	—	TGFB	TGFA
MTU2	TCNT								
MTU2	TGRA								
MTU2	TGRB								
MTU6	TCR		CCLR[2:0]		CKEG[1:0]			TPSC[2:0]	
MTU7	TCR		CCLR[2:0]		CKEG[1:0]			TPSC[2:0]	
MTU6	TMDR1	—	—	BFB	BFA			MD[3:0]	
MTU7	TMDR1	—	—	BFB	BFA			MD[3:0]	
MTU6	TIORH			IOB[3:0]				IOA[3:0]	
MTU6	TIORL			IOD[3:0]				IOC[3:0]	
MTU7	TIORH			IOB[3:0]				IOA[3:0]	

**Table 4.2 List of I/O Registers (Bit Order) (21 / 30)**

Module Abbreviation	Register Abbreviation	Bit 31/23/15/7	Bit 30/22/14/6	Bit 29/21/13/5	Bit 28/20/12/4	Bit 27/19/11/3	Bit 26/18/10/2	Bit 25/17/9/1	Bit 24/16/8/0
MTU7	TIORL	IOD[3:0]			IOC[3:0]				
MTU6	TIER	TTEG	—	—	TCIEV	TGIED	TGIEC	TGIEB	TGIEA
MTU7	TIER	TTEG	TTEG2	—	TCIEV	TGIED	TGIEC	TGIEB	TGIEA
MTU	TOERB	—	—	OE7D	OE7C	OE6D	OE7B	OE7A	OE6B
MTU	TOCR1B	—	PSYE	—	—	TOCL	TOCS	OLSN	OLSP
MTU6	TCNT								
MTU7	TCNT								
MTU	TCDRB								
MTU	TDDR1B								
MTU6	TGRA								
MTU6	TGRB								
MTU7	TGRA								
MTU7	TGRB								
MTU	TCNTSB								
MTU	TCBRB								
MTU6	TGRC								
MTU6	TGRD								
MTU7	TGRC								
MTU7	TGRD								
MTU6	TSR	TCFD	—	—	TCFV	TGFD	TGFC	TGFB	TGFA
MTU7	TSR	TCFD	—	—	TCFV	TGFD	TGFC	TGFB	TGFA
MTU	TITCR1B	T6AEN	T6ACOR[2:0]		T7VEN		T7VCOR[2:0]		
MTU	TITCNT1B	—	T6ACNT[2:0]		—		T7VCNT[2:0]		
MTU	TBTERB	—	—	—	—	—	BTE[1:0]		
MTU	TDERB	—	—	—	—	—	—	TDER	
MTU	TOLBRB	—	—	OLS3N	OLS3P	OLS2N	OLS2P	OLS1N	OLS1P
MTU6	TBTM	—	—	—	—	—	—	TTSB	TTSA
MTU7	TBTM	—	—	—	—	—	—	TTSB	TTSA
MTU	TITMRB	—	—	—	—	—	—	TITM	
MTU	TITCR2B	—	—	—	—	—	TRGCOR[2:0]		
MTU	TITCNT2B	—	—	—	—	—	TRGCNT[2:0]		
MTU7	TADCR	BF[1:0]		—	—	—	—	—	—
		UT7AE	DT7AE	UT7BE	DT7BE	ITA6AE	ITA7VE	ITB6AE	ITB7VE
MTU7	TADCORA								
MTU7	TADCORB								
MTU7	TADCOBRA								



**Table 4.2 List of I/O Registers (Bit Order) (22 / 30)**

Module Abbreviation	Register Abbreviation	Bit 31/23/15/7	Bit 30/22/14/6	Bit 29/21/13/5	Bit 28/20/12/4	Bit 27/19/11/3	Bit 26/18/10/2	Bit 25/17/9/1	Bit 24/16/8/0
MTU7	TADCOBRB								
MTU	TSYCR	CE0A	CE0D	CE0C	CE0D	CE1A	CE1B	CE2A	CE2B
MTU	TWCRB	CCE	—	—	—	—	—	SCC	WRE
MTU	TMDR2B	—	—	—	—	—	—	—	DRS
MTU6	TGRE								
MTU7	TGRE								
MTU7	TGRF								
MTU	TSTRB	CST7	CST6	—	—	—	—	—	—
MTU	TSYRB	SYNC7	SYNC6	—	—	—	—	—	—
MTU	TRWERB	—	—	—	—	—	—	—	RWE
MTU5	TCNTU								
MTU5	TGRU								
MTU5	TCRU	—	—	—	—	—	—	TPSC[1:0]	
MTU5	TIORU	—	—	—	—	—	IOC[4:0]		
MTU5	TCNTV								
MTU5	TGRV								
MTU5	TCRV	—	—	—	—	—	—	TPSC[1:0]	
MTU5	TIORV	—	—	—	—	—	IOC[4:0]		
MTU5	TCNTW								
MTU5	TGRW								
MTU5	TCRW	—	—	—	—	—	—	TPSC[1:0]	
MTU5	TIORW	—	—	—	—	—	IOC[4:0]		
MTU5	TSR	—	—	—	—	—	CMFU5	CMFV5	CMFW5
MTU5	TIER	—	—	—	—	—	TGIE5U	TGIE5V	TGIE5W
MTU5	TSTR	—	—	—	—	—	CSTU5	CSTV5	CSTW5
MTU5	TCNTCMPCLR	—	—	—	—	—	CMPCLR5U	CMPCLR5V	CMPCLR5W
GPT	GTSTR	—	—	—	—	—	—	—	—
		—	—	—	—	CST3	CST2	CST1	CST0
GPT	GTHSCR	CPHW3[1:0]		CPHW2[1:0]		CPHW1[1:0]		CPHW0[1:0]	
		CSHW3[1:0]		CSHW2[1:0]		CSHW1[1:0]		CSHW0[1:0]	
GPT	GTHCCR	—	—	—	—	CCSW3	CCSW2	CCSW1	CCSW0
		CCHW3[1:0]		CCHW2[1:0]		CCHW1[1:0]		CCHW0[1:0]	
GPT	GTHSSR	CSHSL3[3:0]				CSHSL2[3:0]			
		CSHSL1[3:0]				CSHSL0[3:0]			
GPT	GTHPSR	CSHPL3[3:0]				CSHPL2[3:0]			
		CSHPL1[3:0]				CSHPL0[3:0]			
GPT	GTWP	—	—	—	—	—	—	—	—
		—	—	—	—	WP3	WP2	WP1	WP0
GPT	GTSYNC	—	—	SYNC3[1:0]		—	—	SYNC2[1:0]	
		—	—	SYNC1[1:0]		—	—	SYNC0[1:0]	
GPT	GTETINT	—	—	—	—	—	—	ETINF	ETIPF
		—	—	—	—	—	—	ETINEN	ETIPEN

**Table 4.2 List of I/O Registers (Bit Order) (23 / 30)**

Module Abbreviation	Register Abbreviation	Bit 31/23/15/7	Bit 30/22/14/6	Bit 29/21/13/5	Bit 28/20/12/4	Bit 27/19/11/3	Bit 26/18/10/2	Bit 25/17/9/1	Bit 24/16/8/0
GPT	GTBDR	BD33	BD32	BD31	BD30	BD23	BD22	BD21	BD20
		BD13	BD12	BD11	BD10	BD03	BD02	BD01	BD00
GPT	GTSWP	—	—	—	—	—	—	—	—
		—	—	—	—	SWP3	SWP2	SWP1	SWP0
GPT	LCCR	LPSC[1:0]		TPSC[1:0]		LCNTAT		LCTO[2:0]	
		—	LCINTO	LCINTD	LCINTC	—	LCNTS	LCNTR	LCNTE
GPT	LCST	—	—	—	—	—	—	—	—
		—	—	—	—	—	LISO	LISD	LISC
GPT	LCNTA								
GPT	LCNT00								
GPT	LCNT01								
GPT	LCNT02								
GPT	LCNT03								
GPT	LCNT04								
GPT	LCNT05								
GPT	LCNT06								
GPT	LCNT07								
GPT	LCNT08								
GPT	LCNT09								
GPT	LCNT10								
GPT	LCNT11								
GPT	LCNT12								
GPT	LCNT13								
GPT	LCNT14								
GPT	LCNT15								
GPT	LCNTDU								
GPT	LCNTDL								
GPT0	GTIOR	OBHLD	OBDFLT	GTIOB[5:0]					
		OAHL	OADFLT	GTIOA[5:0]					
GPT0	GTINTAD	ADTRBDEN	ADTRBUEN	ADTRADEN	ADTRAUEN	EINT	—	—	—
		GTINTPR[1:0]		GTINTF	GTINTE	GTINTD	GTINTC	GTINTB	GTINTA

**Table 4.2 List of I/O Registers (Bit Order) (24 / 30)**

Module Abbreviation	Register Abbreviation	Bit 31/23/15/7	Bit 30/22/14/6	Bit 29/21/13/5	Bit 28/20/12/4	Bit 27/19/11/3	Bit 26/18/10/2	Bit 25/17/9/1	Bit 24/16/8/0	
GPT0	GTCR	—	—	CCLR[1:0]		—	—	TPCS[1:0]		
		—	—	—	—	—	—	MD[2:0]		
GPT0	GTBER	—	ADTDB	ADTTB[1:0]		—	ADTDA	ADTTA[1:0]		
		—	CCRSWT	PR[1:0]		CCRB[1:0]		CCRA[1:0]		
GPT0	GTUDC	—	—	—	—	—	—	—	—	
		—	—	—	—	—	—	UDF	UD	
GPT0	GTITC	—	ADTBL	—	ADTAL	—	IVTT[2:0]		—	
		IVTC[1:0]		ITLF	ITLE	ITLD	ITLC	ITLB	ITLA	
GPT0	GTST	TUCF		—	—	DTEF		ITCNT[2:0]		
		TCFPU	TCFPO	TCFF	TCFE	TCFD	TCFC	TCFB	TCFA	
GPT0	GTCNT									
GPT0	GTCCRA									
GPT0	GTCCRB									
GPT0	GTCCRC									
GPT0	GTCCRD									
GPT0	GTCCRE									
GPT0	GTCCRF									
GPT0	GTPR									
GPT0	GTPBR									
GPT0	GTPDBR									
GPT0	GTADTRA									
GPT0	GTADTBRA									
GPT0	GTADTDBRA									
GPT0	GTADTRB									
GPT0	GTADTBRB									
GPT0	GTADTDBRB									
GPT0	GTONCR	OBE	OAE	—	SWN	—	—	—	NFV	
		NFS[3:0]			—	NVB	NVA	NEB	NEA	
GPT0	GTDTCR	—	—	—	—	—	—	—	TDFER	
		—	—	TDBDE	TDBUE	—	—	—	TDE	
GPT0	GTDVU									
GPT0	GTDVD									

**Table 4.2 List of I/O Registers (Bit Order) (25 / 30)**

Module Abbreviation	Register Abbreviation	Bit 31/23/15/7	Bit 30/22/14/6	Bit 29/21/13/5	Bit 28/20/12/4	Bit 27/19/11/3	Bit 26/18/10/2	Bit 25/17/9/1	Bit 24/16/8/0
GPT0	GTDBU								
GPT0	GTDBD								
GPT0	GTSOS	—	—	—	—	—	—	—	—
GPT0	GTSOTR	—	—	—	—	—	—	—	SOS[1:0]
GPT0	GTSOTR	—	—	—	—	—	—	—	SOTR
GPT1	GTIOR	OBHLD	OBDFLT						GTIOB[5:0]
GPT1	GTIOR	OAHL	OADFLT						GTIOA[5:0]
GPT1	GTINTAD	ADTRBDEN	ADTRBUEN	ADTRADEN	ADTRAUEN	EINT	—	—	—
GPT1	GTINTAD	GTINTPR[1:0]		GTINTF	GTINTE	GTINTD	GTINTC	GTINTB	GTINTA
GPT1	GTCR	—	—	CCLR[1:0]		—	—	TPCS[1:0]	
GPT1	GTCR	—	—	—	—	—	—	MD[2:0]	
GPT1	GTBER	—	ADTDB	ADTTB[1:0]		—	ADTDA	ADTTA[1:0]	
GPT1	GTBER	—	CCRSWT	PR[1:0]		—	CCRB[1:0]	CCRA[1:0]	
GPT1	GTUDC	—	—	—	—	—	—	—	—
GPT1	GTUDC	—	—	—	—	—	—	UDF	UD
GPT1	GTITC	—	ADTBL	—	ADTAL	—	—	IVTT[2:0]	
GPT1	GTITC	IVTC[1:0]		ITLF	ITLE	ITLD	ITLC	ITLB	ITLA
GPT1	GTST	TUCF	—	—	—	DTEF	—	ITCNT[2:0]	
GPT1	GTST	TCFPU	TCFPO	TCCF	TCFE	TCFD	TCFC	TCFB	TCFA
GPT1	GT CNT								
GPT1	GTCCRA								
GPT1	GTCCRB								
GPT1	GTCCRC								
GPT1	GTCCRD								
GPT1	GTCCRE								
GPT1	GTCCRF								
GPT1	GT PR								
GPT1	GTPBR								
GPT1	GTPDBR								
GPT1	GTADTRA								
GPT1	GTADTBRA								
GPT1	GTADTDBRA								
GPT1	GTADTRB								

**Table 4.2 List of I/O Registers (Bit Order) (26 / 30)**

Module Abbreviation	Register Abbreviation	Bit 31/23/15/7	Bit 30/22/14/6	Bit 29/21/13/5	Bit 28/20/12/4	Bit 27/19/11/3	Bit 26/18/10/2	Bit 25/17/9/1	Bit 24/16/8/0
GPT1	GTADTBRB								
GPT1	GTADTDBRB								
GPT1	GTONCR	OBE	OAE	—	SWN	—	—	—	NFV
		NFS[3:0]				NVB	NVA	NEB	NEA
GPT1	GTDTCR	—	—	—	—	—	—	—	TDFER
		—	—	TDBDE	TDBUE	—	—	—	TDE
GPT1	GTDVU								
GPT1	GTDVD								
GPT1	GTDBU								
GPT1	GTDBD								
GPT1	GTSOS	—	—	—	—	—	—	—	—
		—	—	—	—	—	—	SOS[1:0]	—
GPT1	GTSOTR	—	—	—	—	—	—	—	—
		—	—	—	—	—	—	—	SOTR
GPT2	GTIOR	OBHLD	OBDFLT	GTIOB[5:0]					
		OAHL	OADFLT	GTIOA[5:0]					
GPT2	GTINTAD	ADTRBDEN	ADTRBUEN	ADTRADEN	ADTRAUEN	EINT	—	—	—
		GTINTPR[1:0]		GTINTF	GTINTE	GTINTD	GTINTC	GTINTB	GTINTA
GPT2	GTCR	—	—	CCLR[1:0]		—	—	TPCS[1:0]	
		—	—	—	—	—	—	MD[2:0]	
GPT2	GTBER	—	ADTDB	ADTTB[1:0]		—	ADTDA	ADTTA[1:0]	
		—	CCRSWT	PR[1:0]		CCRB[1:0]		CCRA[1:0]	
GPT2	GTUDC	—	—	—	—	—	—	—	—
		—	—	—	—	—	—	UDF	UD
GPT2	GTITC	—	ADTBL	—	ADTAL	—	IVTT[2:0]		
		IVTC[1:0]		ITLF	ITLE	ITLD	ITLC	ITLB	ITLA
GPT2	GTST	TUCF	—	—	—	DTEF	ITCNT[2:0]		
		TCFPU	TCFPO	TCFF	TCFE	TCFD	TCFC	TCFB	TCFA
GPT2	GCNT								
GPT2	GTCCRA								
GPT2	GTCCRB								
GPT2	GTCCRC								
GPT2	GTCCRD								
GPT2	GTCCRE								
GPT2	GTCCRF								
GPT2	GTPR								

**Table 4.2 List of I/O Registers (Bit Order) (27 / 30)**

Module Abbreviation	Register Abbreviation	Bit 31/23/15/7	Bit 30/22/14/6	Bit 29/21/13/5	Bit 28/20/12/4	Bit 27/19/11/3	Bit 26/18/10/2	Bit 25/17/9/1	Bit 24/16/8/0
GPT2	GTPBR								
GPT2	GTPDBR								
GPT2	GTADTRA								
GPT2	GTADTBRA								
GPT2	GTADTDBRA								
GPT2	GTADTRB								
GPT2	GTADTBRB								
GPT2	GTADTDBRB								
GPT2	GTONCR	OBE	OAE	—	SWN	—	—	—	NFV
					NFS[3:0]	NVB	NVA	NEB	NEA
GPT2	GTDCR	—	—	—	—	—	—	—	TDFER
		—	—	TDBDE	TDBUE	—	—	—	TDE
GPT2	GTDVU								
GPT2	GTDVD								
GPT2	GTDBU								
GPT2	GTDBD								
GPT2	GTSOS	—	—	—	—	—	—	—	—
		—	—	—	—	—	—	SOS[1:0]	—
GPT2	GTSOTR	—	—	—	—	—	—	—	—
		—	—	—	—	—	—	—	SOTR
GPT3	GTIOR	OBHLD	OBDFLT				GTIOB[5:0]		
		OAHL	OADFLT				GTIOA[5:0]		
GPT3	GTINTAD	ADTRBDEN	ADTRBUEN	ADTRADEN	ADTRAUEN	EINT	—	—	—
			GTINTPR[1:0]	GTINTF	GTINTE	GTINTD	GTINTC	GTINTB	GTINTA
GPT3	GTCR	—	—		CCLR[1:0]	—	—	—	—
		—	—	—	—	—	—	—	—
GPT3	GTBER	—	ADTDB	ADTTB[1:0]	—	ADTDA	ADTTA[1:0]		
		—	CCRSWT	PR[1:0]	—	CCRB[1:0]	CCRA[1:0]		
GPT3	GTUDC	—	—	—	—	—	—	—	—
		—	—	—	—	—	—	UDF	UD
GPT3	GTITC	—	ADTBL	—	ADTAL	—	—	IVTT[2:0]	—
		—	IVTC[1:0]	ITLF	ITLE	ITLD	ITLC	ITLB	ITLA
GPT3	GTST	TUCF	—	—	—	DTEF	—	ITCNT[2:0]	—
		TCFPU	TCFPO	TCFF	TCFE	TCFD	TCFC	TCFB	TCFA
GPT3	GCNT								
GPT3	GTCCRA								

**Table 4.2 List of I/O Registers (Bit Order) (28 / 30)**

Module Abbreviation	Register Abbreviation	Bit 31/23/15/7	Bit 30/22/14/6	Bit 29/21/13/5	Bit 28/20/12/4	Bit 27/19/11/3	Bit 26/18/10/2	Bit 25/17/9/1	Bit 24/16/8/0
GPT3	GTCCRB								
GPT3	GTCCRC								
GPT3	GTCCRD								
GPT3	GTCCRE								
GPT3	GTCCRF								
GPT3	GTPR								
GPT3	GTPBR								
GPT3	GTPDBR								
GPT3	GTADTRA								
GPT3	GTADTBRA								
GPT3	GTADTDBRA								
GPT3	GTADTRB								
GPT3	GTADTBRB								
GPT3	GTADTDBRB								
GPT3	GTONCR	OBE	OAE	—	SWN	—	—	—	NFV
					NFS[3:0]	NVB	NVA	NEB	NEA
GPT3	GTDTCR	—	—	—	—	—	—	—	TDFER
		—	—	TDBDE	TDBUE	—	—	—	TDE
GPT3	GTDVU								
GPT3	GTDVD								
GPT3	GTDBU								
GPT3	GTDBD	—	—	—	—	—	—	—	—
		—	—	—	—	—	—	SOS[1:0]	—
GPT3	GTSOS	—	—	—	—	—	—	—	—
		—	—	—	—	—	—	SOS[1:0]	—
GPT3	GTSOTR	—	—	—	—	—	—	—	—
		—	—	—	—	—	—	—	SOTR
GPT0	GTDLYCR	—	—	—	—	—	—	—	—
		—	—	—	—	—	DLYEN	DLYRST	DLLEN
GPT1	GTDLYCR	—	—	—	—	—	—	—	—
		—	—	—	—	—	DLYEN	DLYRST	DLLEN

**Table 4.2 List of I/O Registers (Bit Order) (29 / 30)**

Module Abbreviation	Register Abbreviation	Bit 31/23/15/7	Bit 30/22/14/6	Bit 29/21/13/5	Bit 28/20/12/4	Bit 27/19/11/3	Bit 26/18/10/2	Bit 25/17/9/1	Bit 24/16/8/0
GPT2	GTDLYCR	—	—	—	—	—	—	—	—
		—	—	—	—	—	DLYEN	DLYRST	DLEN
GPT3	GTDLYCR	—	—	—	—	—	—	—	—
		—	—	—	—	—	DLYEN	DLYRST	DLEN
GPT0	GTDLYRA	—	—	—	—	—	—	—	—
GPT0	GTDLYRB	—	—	—	—	—	DLY[4:0]	—	—
		—	—	—	—	—	DLY[4:0]	—	—
GPT1	GTDLYRA	—	—	—	—	—	—	—	—
		—	—	—	—	—	DLY[4:0]	—	—
GPT1	GTDLYRB	—	—	—	—	—	—	—	—
		—	—	—	—	—	DLY[4:0]	—	—
GPT2	GTDLYRA	—	—	—	—	—	—	—	—
		—	—	—	—	—	DLY[4:0]	—	—
GPT2	GTDLYRB	—	—	—	—	—	—	—	—
		—	—	—	—	—	DLY[4:0]	—	—
GPT3	GTDLYRA	—	—	—	—	—	—	—	—
		—	—	—	—	—	DLY[4:0]	—	—
GPT3	GTDLYRB	—	—	—	—	—	—	—	—
		—	—	—	—	—	DLY[4:0]	—	—
GPT0	GTDLYFA	—	—	—	—	—	—	—	—
		—	—	—	—	—	DLY[4:0]	—	—
GPT0	GTDLYFB	—	—	—	—	—	—	—	—
		—	—	—	—	—	DLY[4:0]	—	—
GPT1	GTDLYFA	—	—	—	—	—	—	—	—
		—	—	—	—	—	DLY[4:0]	—	—
GPT1	GTDLYFB	—	—	—	—	—	—	—	—
		—	—	—	—	—	DLY[4:0]	—	—
GPT2	GTDLYRA	—	—	—	—	—	—	—	—
		—	—	—	—	—	DLY[4:0]	—	—
GPT2	GTDLYFB	—	—	—	—	—	—	—	—
		—	—	—	—	—	DLY[4:0]	—	—
GPT3	GTDLYFA	—	—	—	—	—	—	—	—
		—	—	—	—	—	DLY[4:0]	—	—
GPT3	GTDLYFB	—	—	—	—	—	—	—	—
		—	—	—	—	—	DLY[4:0]	—	—
FLASH	FMODR	—	—	—	FRDMD	—	—	—	—
FLASH	FASTAT	ROMAE	—	—	CMDLK	DFLAE	—	DFLRPE	DFLWPE
FLASH	FAEINT	ROMAEIE	—	—	CMDLKIE	DFLAEIE	—	DFLRPEIE	DFLWPEIE
FLASH	FRDYIE	—	—	—	—	—	—	—	FRDYIE
FLASH	DFLRE0	KEY[7:0]							
		DBRE07	DBRE06	DBRE05	DBRE04	DBRE03	DBRE02	DBRE01	DBRE00
FLASH	DFLRE1	KEY[7:0]							
		DBRE15	DBRE14	DBRE13	DBRE12	DBRE11	DBRE10	DBRE09	DBRE08
FLASH	DFLWE0	KEY[7:0]							
		DBWE07	DBWE06	DBWE05	DBWE04	DBWE03	DBWE02	DBWE01	DBWE00
FLASH	DFLWE1	KEY[7:0]							
		DBWE15	DBWE14	DBWE13	DBWE12	DBWE11	DBWE10	DBWE09	DBWE08
FLASH	FCURAME	KEY[7:0]							
		—	—	—	—	—	—	—	FCRME



**Table 4.2 List of I/O Registers (Bit Order) (30 / 30)**

Module Abbreviation	Register Abbreviation	Bit 31/23/15/7	Bit 30/22/14/6	Bit 29/21/13/5	Bit 28/20/12/4	Bit 27/19/11/3	Bit 26/18/10/2	Bit 25/17/9/1	Bit 24/16/8/0
FLASH	FSTATR0	FRDY	ILGLERR	ERSERR	PRGERR	SUSRDY	—	ERSSPD	PRGSPD
FLASH	FSTATR1	FCUERR	—	—	FLOCKST	—	—	—	—
FLASH	FENTRYR	FEKEY[7:0]							
		FENTRYD	—	—	—	—	—	—	FENTRY0
FLASH	FPROTR	FPKEY[7:0]							
		—	—	—	—	—	—	—	FPROTCN
FLASH	FRESETR	FRKEY[7:0]							
		—	—	—	—	—	—	—	FRESET
FLASH	FCMDR	CMDR[7:0]							
		PCMDR[7:0]							
FLASH	FCPSR	—	—	—	—	—	—	—	—
		—	—	—	—	—	—	—	ESUSPMD
FLASH	DFLBCCNT	—	—	—	—	—	BCADR[7:0]		—
		BCADR[7:0]							
		—	—	—	—	—	—	—	BCSIZE
FLASH	FPESTAT	—	—	—	—	—	—	—	—
		PEERRST[7:0]							
FLASH	DFLBCSTAT	—	—	—	—	—	—	—	—
		—	—	—	—	—	—	—	BCST
FLASH	PCKAR	—	—	—	—	—	—	—	—
		PCKA[7:0]							

Note: • In this, the I/O port related registers (0008 C001h to 0008 C116h) indicate the bit configuration of the 112-pin LQFP version. As the configuration of registers and bits differs depending on a package, see section 14, I/O Ports, for details in the User's manual: Hardware.

Note 1. This shows the bit configuration when ADDPR.DPSEL = 0 and ADDPR.DPPRC = 0 (The value has 10-bit accuracy and is padded at the LSB end).

Note 2. This shows the bit configuration when ADCER.ADRFMT = 0 (aligned to the LSB end) and ADCER.ADPRC[1:0] = 00b. For details, refer to section 28, 12-Bit A/D Converter (S12ADA) in the User's manual: Hardware.

Note 3. This function is not supported by the product without the CAN function.

## 5. Electrical Characteristics

### 5.1 Absolute Maximum Ratings

**Table 5.1 Absolute Maximum Ratings**

Item	Symbol	Value	Unit	
Power supply voltage	VCC PLLVCC	-0.3 to +6.5	V	
Input voltage (except for ports 4 to 6)	$V_{IN}$	-0.3 to VCC+0.3	V	
Input voltage (port 4)	$V_{IN}$	-0.3 to AVCC0+0.3	V	
Input voltage (ports 5 and 6)	$V_{IN}$	-0.3 to AVCC+0.3	V	
Analog power supply voltage	AVCC0, AVCC* <sup>1</sup>	-0.3 to +6.5	V	
Reference power supply voltage	VREFH0* <sup>1</sup>	-0.3 to AVCC0+0.3	V	
	VREF* <sup>1</sup>	-0.3 to AVCC+0.3		
Analog input voltage (port 4)	$V_{AN}$	-0.3 to AVCC0+0.3	V	
Analog input voltage (ports 5 and 6)	$V_{AN}$	-0.3 to AVCC+0.3	V	
Operating temperature	D version	$T_{opr}$	-40 to +85	°C
	G version	$T_{opr}$	-40 to +105	°C
Storage temperature	$T_{stg}$	-55 to +125	°C	

Caution: Permanent damage to the LSI may result if absolute maximum ratings are exceeded.

Note 1. Do not leave the AVCC0, VREFH0, VREFL0, AVSS0, AVCC, VREF, and AVSS pins open circuit even if the A/D converter is not to be used.

- When the 12-bit converter is not in use:  
Connect the AVCC0 pin to AVCC (or VCC for a 64-pin product), the VREFH0 pin to VREF (or AVCC or VCC for an 80- or 64-pin product, respectively), and the AVSS0 and VREFL0 pins to VSS.
- When the 10-bit converter is not in use:  
Connect the AVCC pin to AVCC0, the VREF pin to VREFH0, and the AVSS pin to AVSS0.
- When neither the 10- nor the 12-bit converter is in use:  
Connect the AVCC0, VREFH0, AVCC, and VREF pins to VCC, and the AVSS0, VREFL0, and AVSS pins to VSS.

## 5.2 DC Characteristics

**Table 5.2 DC Characteristics (1) (1 / 3)**

Note: Items for which test conditions are not specifically stated in the table below have the same values under conditions 1 to 3.

Condition 1: VCC = PLLVCC = 2.7 to 3.6 V, VSS = PLLVSS = AVSS0 = AVSS = VREFL0 = 0 V  
AVCC0 = AVCC = 3.0 to 3.6 V, VREFH0 = 3.0 V to AVCC0, VREF = 3.0 V to AVCC

Condition 2: VCC = PLLVCC = 2.7 to 3.6 V, VSS = PLLVSS = AVSS0 = AVSS = VREFL0 = 0V  
AVCC0 = AVCC = 4.0 to 5.5 V, VREFH0 = 4.0 V to AVCC0, VREF = 4.0 V to AVCC

Condition 3: VCC = PLLVCC = 4.0 to 5.5 V, VSS = PLLVSS = AVSS0 = AVSS = VREFL0 = 0V  
AVCC0 = AVCC = 4.0 to 5.5 V, VREFH0 = 4.0 V to AVCC0, VREF = 4.0 V to AVCC  
Ta = Topr. Ta is the same under conditions 1 to 3.

Item	Symbol	Min.	Typ.	Max.	Unit	Test Conditions
Schmitt trigger input voltage	CAN input pin IRQ input pin MTU3 input pin POE3 input pin SCI input pin A/D trigger input pin NMI input pin GPT input pin LIN input pin RES#	V <sub>IH</sub>	VCC×0.8	-	VCC+0.3	V
		V <sub>IL</sub>	-0.3	-	VCC×0.2	
		ΔV <sub>T</sub>	VCC ×0.06	-	-	
	RIIC input pin (IICBus)	V <sub>IH</sub>	VCC×0.7	-	VCC+0.3	
		V <sub>IL</sub>	-0.3	-	VCC×0.3	
		ΔV <sub>T</sub>	VCC ×0.05	-	-	
	Port 4*1 (also usable as an analog port)	V <sub>IH</sub>	AVCC0 ×0.8	-	AVCC0 +0.3	
		V <sub>IL</sub>	- 0.3	-	AVCC0 ×0.2	
		ΔV <sub>T</sub>	AVCC0 ×0.06	-	-	
	Ports 5 and 6*1 (also usable as analog ports)	V <sub>IH</sub>	AVCC ×0.8	-	AVCC +0.3	
		V <sub>IL</sub>	-0.3	-	AVCC ×0.2	
		ΔV <sub>T</sub>	AVCC ×0.06	-	-	
	Ports 1 to 3*1 Ports 7 to B*1 Ports D, E, and G*1	V <sub>IH</sub>	VCC×0.8	-	VCC+0.3	
		V <sub>IL</sub>	-0.3	-	VCC×0.2	
		ΔV <sub>T</sub>	VCC ×0.06	-	-	
Input high voltage (except Schmitt trigger input pin)	MD pin, EMLE	V <sub>IH</sub>	VCC×0.9	-	VCC+0.3	V
	EXTAL RSPI input pin		VCC×0.8		VCC+0.3	
	RIIC input pin (SMBus)		2.1		VCC+0.3	
Input low voltage (except Schmitt trigger input pin)	MD pin, EMLE	V <sub>IL</sub>	-0.3	-	VCC×0.1	V
	EXTAL RSPI input pin		-0.3	-	VCC×0.2	
	RIIC input pin (SMBus)		-0.3	-	0.8	

**Table 5.2 DC Characteristics (1) (2 / 3)**

Note: Items for which test conditions are not specifically stated in the table below have the same values under conditions 1 to 3.

Condition 1: VCC = PLLVCC = 2.7 to 3.6 V, VSS = PLLVSS = AVSS0 = AVSS = VREFL0 = 0 V  
AVCC0 = AVCC = 3.0 to 3.6 V, VREFH0 = 3.0 V to AVCC0, VREF = 3.0 V to AVCC

Condition 2: VCC = PLLVCC = 2.7 to 3.6 V, VSS = PLLVSS = AVSS0 = AVSS = VREFL0 = 0V  
AVCC0 = AVCC = 4.0 to 5.5 V, VREFH0 = 4.0 V to AVCC0, VREF = 4.0 V to AVCC

Condition 3: VCC = PLLVCC = 4.0 to 5.5 V, VSS = PLLVSS = AVSS0 = AVSS = VREFL0 = 0V  
AVCC0 = AVCC = 4.0 to 5.5 V, VREFH0 = 4.0 V to AVCC0, VREF = 4.0 V to AVCC

Ta = Topr. Ta is the same under conditions 1 to 3.

Item		Symbol	Min.	Typ.	Max.	Unit	Test Conditions
Output high voltage	All output pins (except for P71 to P76 and P90 to P95)	V <sub>OH</sub>	VCC-0.5	-	-	V	I <sub>OH</sub> = -1 mA
	P71 to P76		VCC-0.5	-	-		I <sub>OH</sub> = -1mA 64-pin LQFP Condition 3
			VCC-1.0	-	-		I <sub>OH</sub> = -5mA 64-pin LQFP Other than condition 3
	P90 to P95		VCC-0.5	-	-		I <sub>OH</sub> = -1mA 80-pin LQFP or 64-pin LQFP
			VCC-1.0	-	-		I <sub>OH</sub> = -5 mA 112-pin LQFP or 100-pin LQFP
Output low voltage	All output pins (except for P71 to P76, P90 to P95, and RIIC)	V <sub>OL</sub>	-	-	0.5	V	I <sub>OL</sub> = 1.0 mA
	P71 to P76		-	-	0.5		I <sub>OL</sub> = 1.0 mA 64-pin LQFP Other than condition 3
			-	-	1.1		I <sub>OL</sub> = 15 mA Conditions 1 and 2
			-	-	1.4		I <sub>OL</sub> = 15 mA Other than 64-pin LQFP Condition 3
			-	-	0.5		I <sub>OL</sub> = 1.0 mA 80-pin LQFP or 64-pin LQFP
	P90 to P95		-	-	1.1		I <sub>OL</sub> = 15 mA 112-pin LQFP or 100-pin LQFP Conditions 1 and 2
			-	-	1.4		I <sub>OL</sub> = 1 mA 112-pin LQFP or 100-pin LQFP Condition 3
			-	-	0.4		I <sub>OL</sub> = 3 mA
			-	-	0.6		I <sub>OL</sub> = 6 mA
	RIIC pin		-	-	0.4		I <sub>OL</sub> = 3 mA
-		-	0.6	I <sub>OL</sub> = 6 mA			
Input leakage current	RES#, MD pin, EMLE	I <sub>in</sub>	-	-	1.0	μA	V <sub>in</sub> = 0 V, V <sub>in</sub> = VCC
Three-state leakage current (off state)	Ports 1 to A, PB0, PB3 to PB7, D, E, G	I <sub>TSI</sub>	-	-	1.0	μA	V <sub>in</sub> = 0 V, V <sub>in</sub> = VCC
	Ports PB1 and PB2		-	-	5.0		

**Table 5.2 DC Characteristics (1) (3 / 3)**

Note: Items for which test conditions are not specifically stated in the table below have the same values under conditions 1 to 3.

Condition 1: VCC = PLLVCC = 2.7 to 3.6 V, VSS = PLLVSS = AVSS0 = AVSS = VREFL0 = 0 V  
AVCC0 = AVCC = 3.0 to 3.6 V, VREFH0 = 3.0 V to AVCC0, VREF = 3.0 V to AVCC

Condition 2: VCC = PLLVCC = 2.7 to 3.6 V, VSS = PLLVSS = AVSS0 = AVSS = VREFL0 = 0V  
AVCC0 = AVCC = 4.0 to 5.5 V, VREFH0 = 4.0 V to AVCC0, VREF = 4.0 V to AVCC

Condition 3: VCC = PLLVCC = 4.0 to 5.5 V, VSS = PLLVSS = AVSS0 = AVSS = VREFL0 = 0V  
AVCC0 = AVCC = 4.0 to 5.5 V, VREFH0 = 4.0 V to AVCC0, VREF = 4.0 V to AVCC

Ta = Topr. Ta is the same under conditions 1 to 3.

Item		Symbol	Min.	Typ.	Max.	Unit	Test Conditions
Input capacitance	All input pins (except for ports PB1 and PB2)	C <sub>in</sub>	-	-	15	pF	V <sub>in</sub> = 0 V, f = 1 MHz, T <sub>a</sub> = 25°C
	Ports PB1 and PB2		-	-	30		

Note 1. This includes the multiplexed input pins, except in cases where port pins PB1 and PB2 are used as RIIC input pins or port pins P22 to P24, P30, PA3 to PA5, PB0, PD0 to PD2, or PD6 are used as RSPI input pins.

**Table 5.3 DC Characteristics (2)**

Note: Items for which test conditions are not specifically stated in the table below have the same values under conditions 1 to 3.

Condition 1: VCC = PLLVCC = 2.7 to 3.6 V, VSS = PLLVSS = AVSS0 = AVSS = VREFL0 = 0 V  
AVCC0 = AVCC = 3.0 to 3.6 V, VREFH0 = 3.0 V to AVCC0, VREF = 3.0 V to AVCC

Condition 2: VCC = PLLVCC = 2.7 to 3.6 V, VSS = PLLVSS = AVSS0 = AVSS = VREFL0 = 0 V  
AVCC0 = AVCC = 4.0 to 5.5 V, VREFH0 = 4.0 V to AVCC0, VREF = 4.0 V to AVCC

Condition 3: VCC = PLLVCC = 4.0 to 5.5 V, VSS = PLLVSS = AVSS0 = AVSS = VREFL0 = 0 V  
AVCC0 = AVCC = 4.0 to 5.5 V, VREFH0 = 4.0 V to AVCC0, VREF = 4.0 V to AVCC  
Ta = Topr. Ta is the same under conditions 1 to 3.

Item			Symbol	Min.	Typ.	Max.	Unit	Test Conditions
Supply current*1	In operation	Max.*2	I <sub>CC</sub> *3	-	-	70	mA	ICLK = 100 MHz PCLK = 50 MHz
		Normal*4		-	35	-		
		Increased by BGO operation*5		-	15	-		
	Sleep			-	22	60		
	All-module-clock-stop mode*6			-	14	28		
	Standby mode	Software standby mode		-	0.10	3	mA	
		Deep software standby mode		-	20	60	μA	
Analog power supply current	During 12-bit A/D conversion (when a sample-and-hold circuit is in use; per unit)		AI <sub>CC0</sub>	-	3	5	mA	
	During 12-bit A/D conversion (when a sample-and-hold circuit is not in use; per unit)			-	3	5	mA	
	Programmable gain amp (per channel)			-	1	2	mA	
	Window comparator (1 channel)			-	0.5	1	mA	
	Window comparator (6 channels)			-	1	2	mA	
	During 12-bit A/D conversion (per unit)			-	60	90	μA	
	During 10-bit A/D conversion (per unit)		AI <sub>CC</sub>	-	0.9	2	mA	
	Waiting for 10-bit A/D conversion (all units)			-	0.3	3	μA	
Reference power supply current	During 12-bit A/D conversion (per unit)		AI <sub>REFH0</sub>	-	1.6	3	mA	
	Waiting for 12-bit A/D conversion (all units)			-	1.6	3	mA	
	During 10-bit A/D conversion (per unit)		AI <sub>REF</sub>	-	0.1	1	mA	
	Waiting for 10-bit A/D conversion (all units)			-	0.1	3	μA	
VCC rising gradient			SV <sub>CC</sub>	-	-	20	ms/V	

Note 1. Supply current values are with all output pins unloaded.

Note 2. Measured with clocks supplied to the peripheral functions. This does not include the BGO operation.

Note 3. I<sub>CC</sub> depends on f (ICLK) as follows. (ICLK: PCLK = 8:4)

ICC max. = 0.54 x f + 16 (max.)

ICC max. = 0.3 x f + 5 (normal operation)

ICC max. = 0.44 x f + 16 (sleep mode)

Note 4. Measured with clocks not supplied to the peripheral functions. This does not include the BGO operation.

Note 5. Incremented if data is written to or erased from the ROM or data flash for data storage during the program execution.

Note 6. The values are for reference.

**Table 5.4 Permissible Output Currents**

Note: Items for which test conditions are not specifically stated in the table below have the same values under conditions 1 to 3.

Condition 1: VCC = PLLVCC = 2.7 to 3.6 V, VSS = PLLVSS = AVSS0 = AVSS = VREFL0 = 0 V  
AVCC0 = AVCC = 3.0 to 3.6 V, VREFH0 = 3.0 V to AVCC0, VREF = 3.0 V to AVCC

Condition 2: VCC = PLLVCC = 2.7 to 3.6 V, VSS = PLLVSS = AVSS0 = AVSS = VREFL0 = 0 V  
AVCC0 = AVCC = 4.0 to 5.5 V, VREFH0 = 4.0 V to AVCC0, VREF = 4.0 V to AVCC

Condition 3: VCC = PLLVCC = 4.0 to 5.5 V, VSS = PLLVSS = AVSS0 = AVSS = VREFL0 = 0 V  
AVCC0 = AVCC = 4.0 to 5.5 V, VREFH0 = 4.0 V to AVCC0, VREF = 4.0 V to AVCC  
Ta = Topr. Ta is the same under conditions 1 to 3.

Item	Symbol	Min.	Typ.	Max.	Unit
Permissible output low current (average value per pin)	$I_{OL}$	-	-	2.0*1	mA
Permissible output low current (max. value per pin)	$I_{OL}$	-	-	4.0*1	mA
Permissible output low current (total)	$\Sigma I_{OL}$	-	-	110	mA
Permissible output high current (average value per pin)	$-I_{OH}$	-	-	2.0*1	mA
Permissible output high current (max. value per pin)	$-I_{OH}$	-	-	4.0*1	mA
Permissible output high current (total)	$\Sigma -I_{OH}$	-	-	35	mA

Caution: To protect the LSI's reliability, the output current values should not exceed the permissible output current.

Note 1.  $I_{OL} = 15$  mA (max.) /  $-I_{OH} = 5$  mA (max.) for P71 to P76 and P90 to P95. Note, however, that up to 6 (112-pin or 100-pin LQFP) or 3 (80-pin or 64-pin LQFP) pins can accept over 2.0-mA  $I_{OL}$  /  $-I_{OH}$  at the same time.

**Table 5.5 Permissible Power Consumption (Only for G Version)**

Note: Items for which test conditions are not specifically stated in the table below have the same values under conditions 1 to 3.

Condition 1: VCC = PLLVCC = 2.7 to 3.6 V, VSS = PLLVSS = AVSS0 = AVSS = VREFL0 = 0 V  
AVCC0 = AVCC = 3.0 to 3.6 V, VREFH0 = 3.0 V to AVCC0, VREF = 3.0 V to AVCC

Condition 2: VCC = PLLVCC = 2.7 to 3.6 V, VSS = PLLVSS = AVSS0 = AVSS = VREFL0 = 0 V  
AVCC0 = AVCC = 4.0 to 5.5 V, VREFH0 = 4.0 V to AVCC0, VREF = 4.0 V to AVCC

Condition 3: VCC = PLLVCC = 4.0 to 5.5 V, VSS = PLLVSS = AVSS0 = AVSS = VREFL0 = 0 V  
AVCC0 = AVCC = 4.0 to 5.5 V, VREFH0 = 4.0 V to AVCC0, VREF = 4.0 V to AVCC

Ta = Topr. Ta is the same under conditions 1 to 3.

Item	Symbol	Typ.	Max.	Unit	Test Conditions
Total permissible power consumption*1	Pd	—	325	mW	85°C < Ta ≤ 105°C

Note: • Please contact Renesas Electronics sales office for derating of operation under Ta = +85°C to +105°C. Derating is the systematic reduction of load for improved reliability.

Note 1. The total power consumption of the whole chip including output current.

### 5.3 AC Characteristics

**Table 5.6 Operation Frequency Value**

Note: Items for which test conditions are not specifically stated in the table below have the same values under conditions 1 to 3.

Condition 1: VCC = PLLVCC = 2.7 to 3.6 V, VSS = PLLVSS = AVSS0 = AVSS = VREFL0 = 0 V  
AVCC0 = AVCC = 3.0 to 3.6 V, VREFH0 = 3.0 V to AVCC0, VREF = 3.0 V to AVCC

Condition 2: VCC = PLLVCC = 2.7 to 3.6 V, VSS = PLLVSS = AVSS0 = AVSS = VREFL0 = 0 V  
AVCC0 = AVCC = 4.0 to 5.5 V, VREFH0 = 4.0 V to AVCC0, VREF = 4.0 V to AVCC

Condition 3: VCC = PLLVCC = 4.0 to 5.5 V, VSS = PLLVSS = AVSS0 = AVSS = VREFL0 = 0 V  
AVCC0 = AVCC = 4.0 to 5.5 V, VREFH0 = 4.0 V to AVCC0, VREF = 4.0 V to AVCC  
Ta = Topr. Ta is the same under conditions 1 to 3.

Item	Symbol	Min.	Typ.	Max.	Unit	
Operating frequency	System clock (ICLK)	f	8	-	100	MHz
	Peripheral module clock (PCLK)		8	-	50	

#### 5.3.1 Clock Timing

**Table 5.7 Clock Timing**

Note: Items for which test conditions are not specifically stated in the table below have the same values under conditions 1 to 3.

Condition 1: VCC = PLLVCC = 2.7 to 3.6 V, VSS = PLLVSS = AVSS0 = AVSS = VREFL0 = 0 V  
AVCC0 = AVCC = 3.0 to 3.6 V, VREFH0 = 3.0 V to AVCC0, VREF = 3.0 V to AVCC

Condition 2: VCC = PLLVCC = 2.7 to 3.6 V, VSS = PLLVSS = AVSS0 = AVSS = VREFL0 = 0 V  
AVCC0 = AVCC = 4.0 to 5.5 V, VREFH0 = 4.0 V to AVCC0, VREF = 4.0 V to AVCC

Condition 3: VCC = PLLVCC = 4.0 to 5.5 V, VSS = PLLVSS = AVSS0 = AVSS = VREFL0 = 0 V  
AVCC0 = AVCC = 4.0 to 5.5 V, VREFH0 = 4.0 V to AVCC0, VREF = 4.0 V to AVCC

Ta = Topr. Ta is the same under conditions 1 to 3.

Item	Symbol	Min.	Max.	Unit	Test Conditions
Oscillation settling time after reset (crystal)	t <sub>OSC1</sub>	10	-	ms	Figure 5.1
Oscillation settling time after leaving software standby mode (crystal)	t <sub>OSC2</sub>	10	-	ms	Figure 5.2
Oscillation settling time after leaving deep software standby mode (crystal)	t <sub>OSC3</sub>	10	-	ms	Figure 5.3
EXTAL external clock output delay settling time	t <sub>DEXT</sub>	1	-	ms	Figure 5.1
EXTAL external clock input low pulse width	t <sub>EXL</sub>	35	-	ns	Figure 5.4
EXTAL external clock input high pulse width	t <sub>EXH</sub>	35	-	ns	
EXTAL external clock rising time	t <sub>EXr</sub>	-	5	ns	
EXTAL external clock falling time	t <sub>EXf</sub>	-	5	ns	
On-chip oscillator (IWDTCCLK) oscillation frequency	f <sub>IWDTCCLK</sub>	62.5	187.5	kHz	





Figure 5.1 Oscillation Settling Timing



Figure 5.2 Oscillation Settling Timing after Software Standby Mode



Figure 5.3 Oscillation Settling Timing after Deep Software Standby Mode



Figure 5.4 EXTAL External Input Clock Timing

### 5.3.2 Control Signal Timing

**Table 5.8 Control Signal Timing**

Note: Items for which test conditions are not specifically stated in the table below have the same values under conditions 1 to 3.

Condition 1: VCC = PLLVCC = 2.7 to 3.6 V, VSS = PLLVSS = AVSS0 = AVSS = VREFL0 = 0 V  
 AVCC0 = AVCC = 3.0 to 3.6 V, VREFH0 = 3.0 V to AVCC0, VREF = 3.0 V to AVCC

Condition 2: VCC = PLLVCC = 2.7 to 3.6 V, VSS = PLLVSS = AVSS0 = AVSS = VREFL0 = 0 V  
 AVCC0 = AVCC = 4.0 to 5.5 V, VREFH0 = 4.0 V to AVCC0, VREF = 4.0 V to AVCC

Condition 3: VCC = PLLVCC = 4.0 to 5.5 V, VSS = PLLVSS = AVSS0 = AVSS = VREFL0 = 0 V  
 AVCC0 = AVCC = 4.0 to 5.5 V, VREFH0 = 4.0 V to AVCC0, VREF = 4.0 V to AVCC  
 Ta = Topr. Ta is the same under conditions 1 to 3.

Item	Symbol	Min.	Max.	Unit	Test Conditions
RES# pulse width (except for programming or erasure of the ROM or data-flash memory or blank checking of the data-flash memory*1)	$t_{RESW}^{*2}$	20	-	$t_{cyc}^{*4}$	Figure 5.5
		1.5	-	$\mu\text{s}$	
Internal reset time*3	$t_{RESW2}$	35	-	$\mu\text{s}$	
NMI pulse width	$t_{NMIW}$	200	-	ns	Figure 5.6
IRQ pulse width	$t_{IRQW}$	200	-	ns	Figure 5.7

Note 1. For a reset by the signal on the RES# pin during programming or erasure of the ROM or data-flash memory or during blank checking of the data-flash memory, see section 31.12, Usage Notes in section 31, ROM (Flash Memory for Code Storage) in the User's manual: Hardware.

Note 2. Both the time and the number of cycles should satisfy the specifications.

Note 3. This is to specify the FCU reset.

Note 4. ICLK cycles.

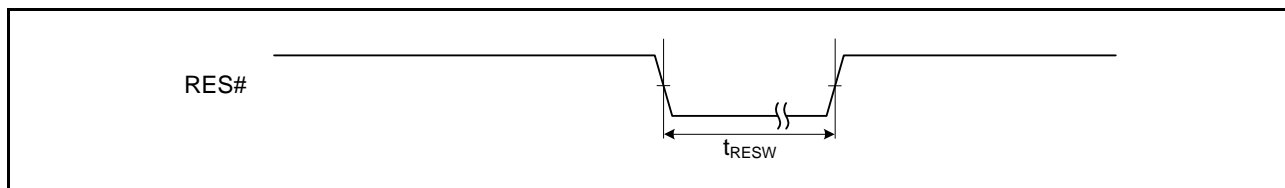

**Figure 5.5 Reset Input Timing**

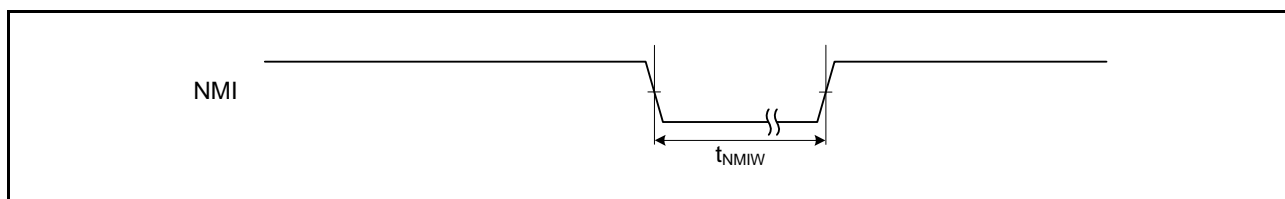

**Figure 5.6 NMI Interrupt Input Timing**

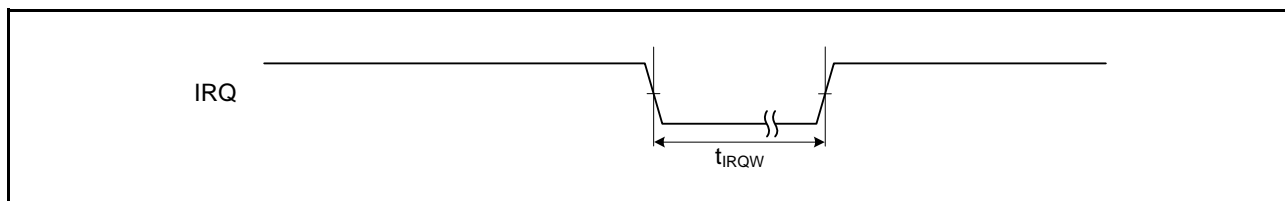

**Figure 5.7 IRQ Interrupt Input Timing**

### 5.3.3 Timing of On-Chip Peripheral Modules

**Table 5.9 Timing of On-Chip Peripheral Modules (1)**

Note: Items for which test conditions are not specifically stated in the table below have the same values under conditions 1 to 3.

Condition 1: VCC = PLLVCC = 2.7 to 3.6 V, VSS = PLLVSS = AVSS0 = AVSS = VREFL0 = 0 V  
 AVCC0 = AVCC = 3.0 to 3.6 V, VREFH0 = 3.0 V to AVCC0, VREF = 3.0 V to AVCC

Condition 2: VCC = PLLVCC = 2.7 to 3.6 V, VSS = PLLVSS = AVSS0 = AVSS = VREFL0 = 0 V  
 AVCC0 = AVCC = 4.0 to 5.5 V, VREFH0 = 4.0 V to AVCC0, VREF = 4.0 V to AVCC

Condition 3: VCC = PLLVCC = 4.0 to 5.5 V, VSS = PLLVSS = AVSS0 = AVSS = VREFL0 = 0 V  
 AVCC0 = AVCC = 4.0 to 5.5 V, VREFH0 = 4.0 V to AVCC0, VREF = 4.0 V to AVCC  
 Ta = Topr. Ta is the same under conditions 1 to 3.

Item	Symbol	Min.	Typ.	Max.	Unit		
SCI	Input clock cycle	Asynchronous	$t_{Scyc}$	$4 \times t_{Pcyc}$	-	ns	Figure 5.8
		Clock synchronous		$6 \times t_{Pcyc}$	-		
	Input clock pulse width	$t_{SCKW}$	$0.4 \times t_{Pcyc}$	$0.6 \times t_{Scyc}$	ns		
	Input clock rise time	$t_{SCKr}$	-	20	ns		
	Input clock fall time	$t_{SCKf}$	-	20	ns		
	Output clock cycle	Asynchronous	$t_{Scyc}$	$16 \times t_{Pcyc}$	-	ns	
		Clock synchronous		$6 \times t_{Pcyc}$	-	ns	
	Output clock pulse width	$t_{SCKW}$	$0.4 \times t_{Scyc}$	$0.6 \times t_{Scyc}$	ns		
	Output clock rise time	$t_{SCKr}$	-	20	ns		
	Output clock fall time	$t_{SCKf}$	-	20	ns		
Transmit data delay time (clock synchronous)	$t_{TXD}$	-	40	ns	Figure 5.9		
Receive data setup time (clock synchronous)	$t_{RXS}$	40	-	ns			
Receive data hold time (clock synchronous)	$t_{RXH}$	40	-	ns			

Note: •  $t_{Pcyc}$ : PCLK cycle



Figure 5.8 SCK Clock Input Timing



Figure 5.9 SCI Input/Output Timing: Clock Synchronous Mode

**Table 5.10 Timing of On-Chip Peripheral Modules (2)**

Note: Items for which test conditions are not specifically stated in the table below have the same values under conditions 1 to 3.

Condition 1: VCC = PLLVCC = 2.7 to 3.6 V, VSS = PLLVSS = AVSS0 = AVSS = VREFL0 = 0 V  
AVCC0 = AVCC = 3.0 to 3.6 V, VREFH0 = 3.0 V to AVCC0, VREF = 3.0 V to AVCC

Condition 2: VCC = PLLVCC = 2.7 to 3.6 V, VSS = PLLVSS = AVSS0 = AVSS = VREFL0 = 0 V  
AVCC0 = AVCC = 4.0 to 5.5 V, VREFH0 = 4.0 V to AVCC0, VREF = 4.0 V to AVCC

Condition 3: VCC = PLLVCC = 4.0 to 5.5 V, VSS = PLLVSS = AVSS0 = AVSS = VREFL0 = 0 V  
AVCC0 = AVCC = 4.0 to 5.5 V, VREFH0 = 4.0 V to AVCC0, VREF = 4.0 V to AVCC  
Ta = Topr. Ta is the same under conditions 1 to 3.

Item		Symbol	Min.*1 *2	Max.	Unit	Test Conditions
RIIC (standard mode)	SCL input cycle time	$t_{SCL}$	$6(12) \times t_{IICcyc} + 1300$	-	ns	Figure 5.10
	SCL input high pulse width	$t_{SCLH}$	$3(6) \times t_{IICcyc} + 300$	-	ns	
	SCL input low pulse width	$t_{SCLL}$	$3(6) \times t_{IICcyc} + 1000$	-	ns	
	SCL, SDA input rising time	$t_{Sr}$	-	1000	ns	
	SCL, SDA input falling time	$t_{Sf}$	-	300	ns	
	SCL, SDA input spike pulse removal time	$t_{SP}$	0	$1(4) \times t_{IICcyc}$	ns	
	SDA input bus free time	$t_{BUF}$	$3(6) \times t_{IICcyc} + 300$	-	ns	
	Start condition input hold time	$t_{STAH}$	$t_{IICcyc} + 300$	-	ns	
	Re-start condition input setup time	$t_{STAS}$	1000	-	ns	
	Stop condition input setup time	$t_{STOS}$	1000	-	ns	
	Data input setup time	$t_{SDAS}$	$t_{IICcyc} + 50$	-	ns	
	Data input hold time	$t_{SDAH}$	0	-	ns	
	SCL, SDA capacitive load	$C_b$	-	400	pF	
RIIC (fast mode)	SCL input cycle time	$t_{SCL}$	$6(12) \times t_{IICcyc} + 600$	-	ns	
	SCL input high pulse width	$t_{SCLH}$	$3(6) \times t_{IICcyc} + 300$	-	ns	
	SCL input low pulse width	$t_{SCLL}$	$3(6) \times t_{IICcyc} + 300$	-	ns	
	SCL, SDA input rising time	$t_{Sr}$	$20 + 0.1C_b$	300	ns	
	SCL, SDA input falling time	$t_{Sf}$	$20 + 0.1C_b$	300	ns	
	SCL, SDA input spike pulse removal time	$t_{SP}$	0	$1(4) \times t_{IICcyc}$	ns	
	SDA input bus free time	$t_{BUF}$	$3(6) \times t_{IICcyc} + 300$	-	ns	
	Start condition input hold time	$t_{STAH}$	$t_{IICcyc} + 300$	-	ns	
	Re-start condition input setup time	$t_{STAS}$	300	-	ns	
	Stop condition input setup time	$t_{STOS}$	300	-	ns	
	Data input setup time	$t_{SDAS}$	$t_{IICcyc} + 50$	-	ns	
	Data input hold time	$t_{SDAH}$	0	-	ns	
	SCL, SDA capacitive load	$C_b$	-	400	pF	

Note: •  $t_{IICcyc}$ : Cycles of internal base clock (IIC $\phi$ ) for the RIIC module

Note 1. The value in parentheses is used when ICMR3.NF[1:0] are set to 11b while a digital filter is enabled with ICFER.NFE = 1.

Note 2.  $C_b$  indicates the total capacity of the bus line.



Figure 5.10 I2C Bus Interface Input/Output Timing

**Table 5.11 Timing of On-Chip Peripheral Modules (3)**

Note: Items for which test conditions are not specifically stated in the table below have the same values under conditions 1 to 3.

Condition 1: VCC = PLLVCC = 2.7 to 3.6 V, VSS = PLLVSS = AVSS0 = AVSS = VREFL0 = 0 V  
AVCC0 = AVCC = 3.0 to 3.6 V, VREFH0 = 3.0 V to AVCC0, VREF = 3.0 V to AVCC

Condition 2: VCC = PLLVCC = 2.7 to 3.6 V, VSS = PLLVSS = AVSS0 = AVSS = VREFL0 = 0 V  
AVCC0 = AVCC = 4.0 to 5.5 V, VREFH0 = 4.0 V to AVCC0, VREF = 4.0 V to AVCC

Condition 3: VCC = PLLVCC = 4.0 to 5.5 V, VSS = PLLVSS = AVSS0 = AVSS = VREFL0 = 0 V  
AVCC0 = AVCC = 4.0 to 5.5 V, VREFH0 = 4.0 V to AVCC0, VREF = 4.0 V to AVCC  
Ta = Topr. Ta is the same under conditions 1 to 3.

Item		Symbol	Min.	Max.	Unit	Test Conditions		
RSPI	RSPCK clock cycle	Master	$t_{SPcyc}$	4	4096	$t_{Pcyc}$	Figure 5.11	
		Slave		8	4096			
	RSPCK clock high pulse width	Master	$t_{SPCKWH}$	$(t_{SPcyc} - t_{SPCKR} - t_{SPCKF}) / 2-3$	-	ns		
		Slave		$(t_{SPcyc} - t_{SPCKR} - t_{SPCKF}) / 2$	-			
	RSPCK clock low pulse width	Master	$t_{SPCKWL}$	$(t_{SPcyc} - t_{SPCKR} - t_{SPCKF}) / 2-3$	-	ns		
		Slave		$(t_{SPcyc} - t_{SPCKR} - t_{SPCKF}) / 2$	-			
	RSPCK clock rise/fall time	Output	$t_{SPCKR}$	-	5	ns		
		Input	$t_{SPCKF}$	-	1	$\mu s$		
	Data input setup time	Master	$t_{SU}$	25	-	ns		Figure 5.12 to Figure 5.15
		Slave		0	-			
	Data input hold time	Master	$t_H$	0	-	ns		
		Slave		$20+2 \times t_{Pcyc}$	-			
	SSL setup time	Master	$t_{LEAD}$	1	8	$t_{SPcyc}$		
		Slave		4	-	$t_{Pcyc}$		
	SSL hold time	Master	$t_{LAG}$	1	8	$t_{SPcyc}$		
		Slave		4	-	$t_{Pcyc}$		
Data output delay time	Master	$t_{OD}$	-	20	ns			
	Slave		-	$3 \times t_{Pcyc} + 40$				
Data output hold time	Master	$t_{OH}$	0	-	ns			
	Slave		0	-				
Successive transmission delay time	Master	$t_{TD}$	$t_{SPcyc} + 2 \times t_{Pcyc}$	$8 \times t_{SPcyc} + 2 \times t_{Pcyc}$	ns			
	Slave		$4 \times t_{Pcyc}$	-				
MOSI, MISO rise/fall time	Output	$t_{DR}$	-	15	ns	Figure 5.12 to Figure 5.15		
	Input	$t_{DF}$	-	1	$\mu s$			
SSL rise/fall time	Output	$t_{SSLR}$	-	15	ns			
	Input	$t_{SSLF}$	-	1	$\mu s$			
Slave access time		$t_{SA}$	-	4	$t_{Pcyc}$	Figure 5.12 to Figure 5.15		
Slave output release time		$t_{REL}$	-	3	$t_{Pcyc}$			

Note: • Note 1:  $t_{Pcyc}$ : PCLK cycle





Figure 5.11 RSPCK Clock Timing



Figure 5.12 RSPCK Timing (Master, CPHA = 0)



Figure 5.13 RSPI Timing (Master, CPHA = 1)



Figure 5.14 RSPI Timing (Slave, CPHA = 0)



Figure 5.15 RSPI Timing (Slave, CPHA = 1)

**Table 5.12 Timing of On-Chip Peripheral Modules (4)**

Note: Items for which test conditions are not specifically stated in the table below have the same values under conditions 1 to 3.

Condition 1: VCC = PLLVCC = 2.7 to 3.6 V, VSS = PLLVSS = AVSS0 = AVSS = VREFL0 = 0 V  
 AVCC0 = AVCC = 3.0 to 3.6 V, VREFH0 = 3.0 V to AVCC0, VREF = 3.0 V to AVCC

Condition 2: VCC = PLLVCC = 2.7 to 3.6 V, VSS = PLLVSS = AVSS0 = AVSS = VREFL0 = 0 V  
 AVCC0 = AVCC = 4.0 to 5.5 V, VREFH0 = 4.0 V to AVCC0, VREF = 4.0 V to AVCC

Condition 3: VCC = PLLVCC = 4.0 to 5.5 V, VSS = PLLVSS = AVSS0 = AVSS = VREFL0 = 0 V  
 AVCC0 = AVCC = 4.0 to 5.5 V, VREFH0 = 4.0 V to AVCC0, VREF = 4.0 V to AVCC  
 Ta = Topr. Ta is the same under conditions 1 to 3.

Item		Symbol	Min.	Max.	Unit	Test Conditions
MTU3	Input capture input pulse width (single-edge setting)	$t_{TICW}$	3.0	-	$t_{Icyc}$	Figure 5.16
	Input capture input pulse width (both-edge setting)	$t_{TICW}$	5.0	-	$t_{Icyc}$	
	Timer clock pulse width (single-edge setting)	$t_{TCKWH/L}$	3.0	-	$t_{Icyc}$	Figure 5.17
	Timer clock pulse width (both-edge setting)	$t_{TCKWH/L}$	5.0	-	$t_{Icyc}$	
	Timer clock pulse width (phase coefficient mode)	$t_{TCKWH/L}$	5.0	-	$t_{Icyc}$	
GPT	Input capture input pulse width (single-edge setting)	$t_{GTICW}$	3.0	-	$t_{Icyc}$	Figure 5.18
	Input capture input pulse width (both-edge setting)	$t_{GTICW}$	5.0	-	$t_{Icyc}$	

Note: •  $t_{Icyc}$ : ICLK cycle



Figure 5.16 MTU3 Input/Output Timing



Figure 5.17 MTU3 Clock Input Timing



Figure 5.18 GPT Input/Output Timing

Table 5.13 Timing of On-Chip Peripheral Modules (5)

Note: Items for which test conditions are not specifically stated in the table below have the same values under conditions 1 to 3.

Condition 1: VCC = PLLVCC = 2.7 to 3.6 V, VSS = PLLVSS = AVSS0 = AVSS = VREFL0 = 0 V

AVCC0 = AVCC = 3.0 to 3.6 V, VREFH0 = 3.0 V to AVCC0, VREF = 3.0 V to AVCC

Condition 2: VCC = PLLVCC = 2.7 to 3.6 V, VSS = PLLVSS = AVSS0 = AVSS = VREFL0 = 0 V

AVCC0 = AVCC = 4.0 to 5.5 V, VREFH0 = 4.0 V to AVCC0, VREF = 4.0 V to AVCC

Condition 3: VCC = PLLVCC = 4.0 to 5.5 V, VSS = PLLVSS = AVSS0 = AVSS = VREFL0 = 0 V

AVCC0 = AVCC = 4.0 to 5.5 V, VREFH0 = 4.0 V to AVCC0, VREF = 4.0 V to AVCC

Ta = Topr. Ta is the same under conditions 1 to 3.

Item	Symbol	Min.	Max.	Unit	Test Conditions
POE3 POE# input pulse width	t <sub>POEW</sub>	1.5	-	t <sub>Pcyc</sub>	Figure 5.19

Note: • t<sub>Pcyc</sub>: PCLK cycle



Figure 5.19 POE3# Clock Timing

### 5.3.4 Timing of PWM Delay Generation Circuit

Table 5.14 Timing of the PWM Delay Generation Circuit

Note: Items for which test conditions are not specifically stated in the table below have the same values under conditions 1 to 3.

Condition 1: VCC = PLLVCC = 4.0 to 5.5 V, VSS = PLLVSS = AVSS = VREL0 = 0 V

AVCC = AVCC = 4.0 to 5.5 V, VREFH0 = 4.0 V to AVCC0, VREF = 4.0 V to AVCC

Ta = Topr.

Item	Symbol	Typ.	Max.	Unit	Test Conditions
Resolution	—	312.5	—	ps	ICLK = 100 MHz
DNL*1	—	±2.0	—	LSB	

Note 1. This value is correct when the difference between each code and the next is a resolution of one bit (1 LSB).

## 5.4 A/D Conversion Characteristics

**Table 5.15 10-Bit A/D Conversion Characteristics**

Note: Items for which test conditions are not specifically stated in the table below have the same values under conditions 1 to 3.

Condition 1: VCC = PLLVCC = 2.7 to 3.6 V, VSS = PLLVSS = AVSS0 = AVSS = VREFL0 = 0 V  
 AVCC0 = AVCC = 3.0 to 3.6 V, VREFH0 = 3.0 V to AVCC0, VREF = 3.0 V to AVCC  
 Ta = Topr

Item	Min.	Typ.	Max.	Unit	Test Conditions
Resolution	10	10	10	Bit	
Conversion time*1 (AD clock = 25-MHz operation)	2.0	-	-	μs	Sampling 25 states
Analog input capacitance	-	-	4	pF	
Integral nonlinearity error	-	-	±3.0	LSB	
Offset error	-	-	±3.0	LSB	
Full-scale error	-	-	±3.0	LSB	
Quantization error	-	±0.5	-	LSB	
Absolute accuracy	-	-	±4.0	LSB	
Permissible signal source impedance	-	-	1.0	kΩ	

Condition 2: VCC = PLLVCC = 2.7 to 3.6 V, VSS = PLLVSS = AVSS0 = AVSS = VREFL0 = 0 V  
 AVCC0 = AVCC = 4.0 to 5.5 V, VREFH0 = 4.0 V to AVCC0, VREF = 4.0 V to AVCC

Condition 3: VCC = PLLVCC = 4.0 to 5.5 V, VSS = PLLVSS = AVSS0 = AVSS = VREFL0 = 0 V  
 AVCC0 = AVCC = 4.0 to 5.5 V, VREFH0 = 4.0 V to AVCC0, VREF = 4.0 V to AVCC  
 Ta = Topr. Ta is the same under conditions 2 and 3.

Item	Min.	Typ.	Max.	Unit	Test Conditions
Resolution	10	10	10	Bit	
Conversion time*1 (AD clock = 50-MHz operation)	1.0	-	-	μs	Sampling 25 states
Analog input capacitance	-	-	4	pF	
Integral nonlinearity error	-	-	±3.0	LSB	
Offset error	-	-	±3.0	LSB	
Full-scale error	-	-	±3.0	LSB	
Quantization error	-	±0.5	-	LSB	
Absolute accuracy	-	-	±4.0	LSB	
Permissible signal source impedance	-	-	1.0	kΩ	

Note 1. The conversion time includes the sampling time and the comparison time. As the test conditions, the number of sampling states is indicated.

**Table 5.16 12-Bit A/D Conversion Characteristics**

Note: Items for which test conditions are not specifically stated in the table below have the same values under conditions 1 to 3.

Condition 1: VCC = PLLVCC = 2.7 to 3.6 V, VSS = PLLVSS = AVSS0 = AVSS = VREFL0 = 0 V  
 AVCC0 = AVCC = 3.0 to 3.6 V, VREFH0 = 3.0 V to AVCC0, VREF = 3.0 V to AVCC  
 Ta = Topr, ICLK = 8 to 100 MHz, PCLK = 8 to 50 MHz

Item	Min.	Typ.	Max.	Unit	Test Conditions	
Resolution	12	12	12	Bit		
Conversion time*1 (AD clock = 25-MHz operation)	2.0	-	-	μs	Sampling 20 states	
Analog input capacitance	-	-	6	pF		
Integral nonlinearity error	-	-	±4.0	LSB		
Offset error	-	-	±7.5	LSB		
Full-scale error	-	-	±7.5	LSB		
Quantization error	-	±0.5	-	LSB		
Absolute accuracy	When a sample-and-hold circuit is in use	-	-	±8.0	LSB	AVin = 0.25 to AVREFH - 0.25
	When a sample-and-hold circuit is not in use	-	-	±8.0	LSB	AVin = AVREFL to AVREFH
Permissible signal source impedance	-	-	3.0	kΩ		

Condition 2: VCC = PLLVCC = 2.7 to 3.6 V, VSS = PLLVSS = AVSS0 = AVSS = VREFL0 = 0 V  
 AVCC0 = AVCC = 4.0 to 5.5 V, VREFH0 = 4.0 V to AVCC0, VREF = 4.0 V to AVCC

Condition 3: VCC = PLLVCC = 4.0 to 5.5 V, VSS = PLLVSS = AVSS0 = AVSS = VREFL0 = 0 V  
 AVCC0 = AVCC = 4.0 to 5.5 V, VREFH0 = 4.0 V to AVCC0, VREF = 4.0 V to AVCC  
 Ta = Topr. Ta is the same under conditions 2 and 3. ICLK = 8 to 100 MHz, PCLK = 8 to 50 MHz.

Item	Min.	Typ.	Max.	Unit	Test Conditions	
Resolution	12	12	12	Bit		
Conversion time*1 (AD clock = 25-MHz operation)	1.0	-	-	μs	Sampling 20 states	
Analog input capacitance	-	-	6	pF		
Integral nonlinearity error	-	-	±4.0	LSB		
Offset error	-	-	±7.5	LSB		
Full-scale error	-	-	±7.5	LSB		
Quantization error	-	±0.5	-	LSB		
Absolute accuracy	When a sample-and-hold circuit is in use	-	-	±8.0	LSB	AVin = 0.25 to AVREFH - 0.25
	When a sample-and-hold circuit is not in use	-	-	±8.0	LSB	AVin = AVREFL to AVREFH
Permissible signal source impedance	-	-	3.0	kΩ		

Note 1. The conversion time includes the sampling time and the comparison time. As the test conditions, the number of sampling states is indicated.

**Table 5.17 Characteristics of the Programmable Gain Amplifier**

Note: Items for which test conditions are not specifically stated in the table below have the same values under conditions 1 to 3.

Condition 1: VCC = PLLVCC = 2.7 to 3.6 V, VSS = PLLVSS = AVSS0 = AVSS = VREFL0 = 0 V  
AVCC0 = AVCC = 3.0 to 3.6 V, VREFH0 = 3.0 V to AVCC0, VREF = 3.0 V to AVCC

Condition 2: VCC = PLLVCC = 2.7 to 3.6 V, VSS = PLLVSS = AVSS0 = AVSS = VREFL0 = 0 V  
AVCC0 = AVCC = 4.0 to 5.5 V, VREFH0 = 4.0 V to AVCC0, VREF = 4.0 V to AVCC

Condition 3: VCC = PLLVCC = 4.0 to 5.5 V, VSS = PLLVSS = AVSS0 = AVSS = VREFL0 = 0 V  
AVCC0 = AVCC = 4.0 to 5.5V, VREFH0 = 4.0 V to AVCC0, VREF = 4.0 V to AVCC  
Ta = Topr. Ta is the same under conditions 1 to 3.

Item	Symbol	Min.	Typ.	Max.	Unit	Test Conditions
Analog input capacitance	Cin	-	-	6	pF	
Input offset voltage	Voff	-	-	8	mV	
Input voltage range (Vin)	Gain × 2.000	0.050 × AVcc	-	0.450 × AVcc	V	
	Gain × 2.500	0.047 × AVcc	-	0.360 × AVcc		
	Gain × 3.077	0.045 × AVcc	-	0.292 × AVcc		
	Gain × 3.636	0.042 × AVcc	-	0.247 × AVcc		
	Gain × 4.000	0.040 × AVcc	-	0.212 × AVcc		
	Gain × 4.444	0.036 × AVcc	-	0.191 × AVcc		
	Gain × 5.000	0.033 × AVcc	-	0.170 × AVcc		
	Gain × 5.714	0.031 × AVcc	-	0.148 × AVcc		
	Gain × 6.667	0.029 × AVcc	-	0.127 × AVcc		
	Gain × 10.000	0.025 × AVcc	-	0.08 × AVcc		
	Gain × 13.333	0.023 × AVcc	-	0.06 × AVcc		
Slew rate	SR	10	-	-	V/μs	
Gain error	Gain × 2.000	-	-	1	%	
	Gain × 2.500	-	-	1		
	Gain × 3.077	-	-	1		
	Gain × 3.636	-	-	1.5		
	Gain × 4.000	-	-	1.5		
	Gain × 4.444	-	-	2		
	Gain × 5.000	-	-	2		
	Gain × 5.714	-	-	2		
	Gain × 6.667	-	-	3		
	Gain × 10.000	-	-	4		
	Gain × 13.333	-	-	4		



**Table 5.18 Comparator Characteristics**

Note: Items for which test conditions are not specifically stated in the table below have the same values under conditions 1 to 3.

Condition 1: VCC = PLLVCC = 2.7 to 3.6 V, VSS = PLLVSS = AVSS0 = AVSS = VREFL0 = 0 V

AVCC0 = AVCC = 3.0 to 3.6 V, VREFH0 = 3.0 V to AVCC0, VREF = 3.0 V to AVCC

Condition 2: VCC = PLLVCC = 2.7 to 3.6 V, VSS = PLLVSS = AVSS0 = AVSS = VREFL0 = 0 V

AVCC0 = AVCC = 4.0 to 5.5 V, VREFH0 = 4.0 V to AVCC0, VREF = 4.0 V to AVCC

Condition 3: VCC = PLLVCC = 4.0 to 5.5 V, VSS = PLLVSS = AVSS0 = AVSS = VREFL0 = 0 V

AVCC0 = AVCC = 4.0 to 5.5 V, VREFH0 = 4.0 V to AVCC0, VREF = 4.0 V to AVCC

Ta = Topr. Ta is the same under conditions 1 to 3.

Item	Symbol	Min.	Typ.	Max.	Unit	Test Conditions
Analog input capacitance	Cin	-	-	6	pF	
REFH pin offset voltage	Voff	-	-	5	mV	
REFL pin offset voltage		-	-	5	mV	
REFH input voltage range	Vin	1.7	-	AVcc - 0.3	V	
REFL input voltage range		0.3	-	AVcc - 1.7	V	
REFH reply time	tCR	-	-	1	μs	
REFL reply time	tCF	-	-	1	μs	

### 5.5 Power-on Reset Circuit, Voltage Detection Circuit Characteristics

**Table 5.19 Power-on Reset Circuit, Voltage Detection Circuit Characteristics**

Note: Items for which test conditions are not specifically stated in the table below have the same values under conditions 1 to 3.

Condition 1: VCC = PLLVCC = 2.7 to 3.6 V, VSS = PLLVSS = AVSS0 = AVSS = VREFL0 = 0 V  
 AVCC0 = AVCC = 3.0 to 3.6 V, VREFH0 = 3.0 V to AVCC0, VREF = 3.0 V to AVCC

Condition 2: VCC = PLLVCC = 2.7 to 3.6 V, VSS = PLLVSS = AVSS0 = AVSS = VREFL0 = 0 V  
 AVCC0 = AVCC = 4.0 to 5.5 V, VREFH0 = 4.0 V to AVCC0, VREF = 4.0 V to AVCC

Ta = Topr. Ta is the same under conditions 1 and 2.

Item	Symbol	Min.	Typ.	Max.	Unit	Test Conditions	
Voltage detection level	Power-on reset (POR)	V <sub>POR</sub>	2.48	2.60	2.72	V	Figure 5.20
	Voltage detection circuit (LVD)	V <sub>det1</sub>	2.68	2.80	2.92		Figure 5.21
		V <sub>det2</sub>	2.98	3.10	3.22		Figure 5.22
Internal reset time	t <sub>POR</sub>	20	35	50	ms	Figure 5.21 and Figure 5.22	
Min. VCC down time*1	t <sub>VOFF</sub>	200	-	-	us	Figure 5.20 to Figure 5.22	
Reply delay time	t <sub>det</sub>	-	-	200	us		

Condition 3: VCC = PLLVCC = 4.0 to 5.5 V, VSS = PLLVSS = AVSS0 = AVSS = VREFL0 = 0 V  
 AVCC0 = AVCC = 4.0 to 5.5 V, VREFH0 = 4.0 V to AVCC0, VREF = 4.0 V to AVCC

Ta = Topr

Item	Symbol	Min.	Typ.	Max.	Unit	Test Conditions	
Voltage detection level	Power-on reset (POR)	V <sub>POR</sub>	3.70	3.90	4.10	V	Figure 5.20
	Voltage detection circuit (LVD)	V <sub>det1</sub>	3.95	4.15	4.35		Figure 5.21
		V <sub>det2</sub>	4.40	4.60	4.80		Figure 5.22
Internal reset time	t <sub>POR</sub>	20	35	50	ms	Figure 5.21 and Figure 5.22	
Min. VCC down time*1	t <sub>VOFF</sub>	200	-	-	us	Figure 5.20 to Figure 5.22	
Reply delay time	t <sub>det</sub>	-	-	200	us		

Note 1. The power-off time indicates the time when VCC is below the minimum value of voltage detection levels V<sub>POR</sub>, V<sub>det1</sub>, and V<sub>det2</sub> for the POR/ LVD.

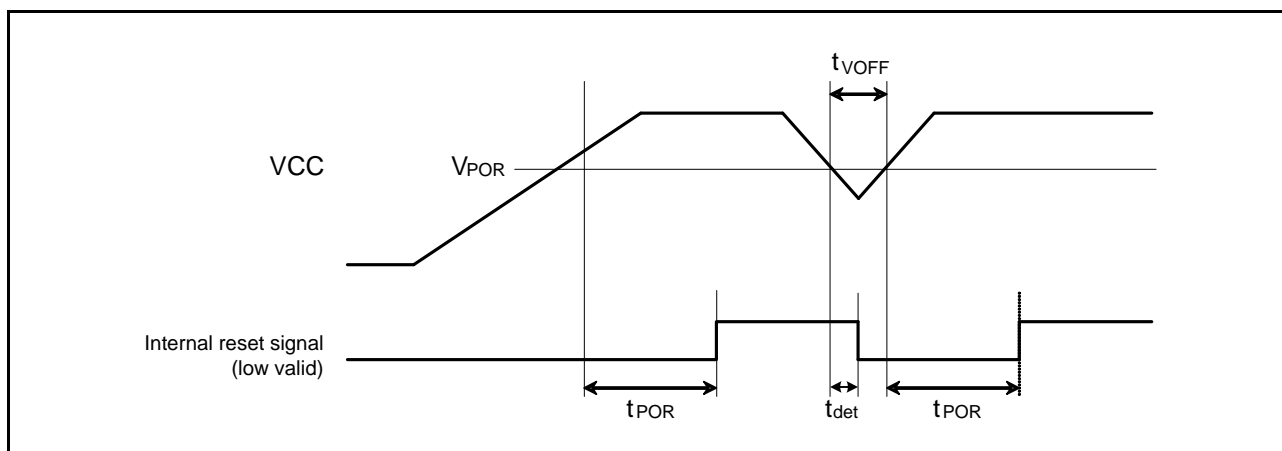

Figure 5.20 Power-on Reset Timing



Figure 5.21 Voltage Detection Circuit Timing ( $V_{det1}$ )



Figure 5.22 Voltage Detection Circuit Timing ( $V_{det2}$ )

### 5.6 Oscillation Stop Detection Timing

**Table 5.20 Oscillation Stop Detection Circuit Characteristics**

Note: Items for which test conditions are not specifically stated in the table below have the same values under conditions 1 to 3.

Condition 1: VCC = PLLVCC = 2.7 to 3.6 V, VSS = PLLVSS = AVSS0 = AVSS = VREFL0 = 0 V  
 AVCC0 = AVCC = 3.0 to 3.6 V, VREFH0 = 3.0 V to AVCC0, VREF = 3.0 V to AVCC

Condition 2: VCC = PLLVCC = 2.7 to 3.6 V, VSS = PLLVSS = AVSS0 = AVSS = VREFL0 = 0 V  
 AVCC0 = AVCC = 4.0 to 5.5 V, VREFH0 = 4.0 V to AVCC0, VREF = 4.0 V to AVCC

Condition 3: VCC = PLLVCC = 4.0 to 5.5 V, VSS = PLLVSS = AVSS0 = AVSS = VREFL0 = 0 V  
 AVCC0 = AVCC = 4.0 to 5.5 V, VREFH0 = 4.0 V to AVCC0, VREF = 4.0 V to AVCC  
 Ta = Topr. Ta is the same under conditions 1 to 3.

Item	Symbol	Min.	Typ.	Max.	Unit	Test Conditions
Detection time	t <sub>dr</sub>	-	-	1.0	ms	Figure 5.23
Internal oscillation frequency when oscillation stop is detected	f <sub>MAIN</sub>	0.5	-	7.0	MHz	



**Figure 5.23 Oscillation Stop Detection Timing**

### 5.7 ROM (Flash Memory for Code Storage) Characteristics

**Table 5.21 ROM (Flash Memory for Code Storage) Characteristics (1)**

Note: Items for which test conditions are not specifically stated in the table below have the same values under conditions 1 to 3.

Condition 1: VCC = PLLVCC = 2.7 to 3.6 V, VSS = PLLVSS = AVSS0 = AVSS = VREFL0 = 0 V  
AVCC0 = AVCC = 3.0 to 3.6 V, VREFH0 = 3.0 V to AVCC0, VREF = 3.0 V to AVCC

Condition 2: VCC = PLLVCC = 2.7 to 3.6 V, VSS = PLLVSS = AVSS0 = AVSS = VREFL0 = 0 V  
AVCC0 = AVCC = 4.0 to 5.5 V, VREFH0 = 4.0 V to AVCC0, VREF = 4.0 V to AVCC

Condition 3: VCC = PLLVCC = 4.0 to 5.5 V, VSS = PLLVSS = AVSS0 = AVSS = VREFL0 = 0 V  
AVCC0 = AVCC = 4.0 to 5.5 V, VREFH0 = 4.0 V to AVCC0, VREF = 4.0 V to AVCC

Temperature range for the programming/erasure operation:  
Ta = Topr. Ta is the same under conditions 1 to 3.

Item	Symbol	Min.	Typ.	Max.	Unit	Test Conditions
Rewrite/erase cycle*1	N <sub>PEC</sub>	1000	—	—	Times	
Data hold time	t <sub>DRP</sub>	30*2	—	—	Year	Ta = +85C°

Note 1. Definition of rewrite/erase cycle:

The rewrite/erase cycle is the number of erasing for each block. When the rewrite/erase cycle is n times (n = 1000), erasing can be performed n times for each block. For instance, when 256-byte writing is performed 16 times for different addresses in 4-Kbyte block and then the entire block is erased, the rewrite/erase cycle is counted as one. However, writing to the same address for several times as one erasing is not enabled (overwriting is prohibited).

Note 2. The value is obtained from the reliability test.

**Table 5.22 ROM (Flash Memory for Code Storage) Characteristics (2)**

Note: Items for which test conditions are not specifically stated in the table below have the same values under conditions 1 to 3.

Condition 1: VCC = PLLVCC = 2.7 to 3.6 V, VSS = PLLVSS = AVSS0 = AVSS = VREFL0 = 0 V  
AVCC0 = AVCC = 3.0 to 3.6 V, VREFH0 = 3.0 V to AVCC0, VREF = 3.0 V to AVCC

Condition 2: VCC = PLLVCC = 2.7 to 3.6 V, VSS = PLLVSS = AVSS0 = AVSS = VREFL0 = 0 V  
AVCC0 = AVCC = 4.0 to 5.5 V, VREFH0 = 4.0 V to AVCC0, VREF = 4.0 V to AVCC

Condition 3: VCC = PLLVCC = 4.0 to 5.5 V, VSS = PLLVSS = AVSS0 = AVSS = VREFL0 = 0 V  
AVCC0 = AVCC = 4.0 to 5.5 V, VREFH0 = 4.0 V to AVCC0, VREF = 4.0 V to AVCC

Temperature range for the programming/erasure operation:  
Ta = Topr. Ta is the same under conditions 1 to 3.

Item	Symbol	Min.	Typ.	Max.	Unit	Test Conditions	
Programming time	256 bytes	t <sub>P256</sub>	—	2	12	ms	PCLK = 50 MHz N <sub>PEC</sub> ≤ 100
	4 Kbytes	t <sub>P4K</sub>	—	23	50	ms	
	16 Kbytes	t <sub>P16K</sub>	—	90	200	ms	
	256 byte	t <sub>P256</sub>	—	2.4	14.4	ms	PCLK = 50 MHz N <sub>PEC</sub> > 100
	4 Kbytes	t <sub>P4K</sub>	—	27.6	60	ms	
	16 Kbytes	t <sub>P16K</sub>	—	108	240	ms	
Erasure time	4 Kbytes	t <sub>E4K</sub>	—	25	60	ms	PCLK = 50 MHz N <sub>PEC</sub> ≤ 100
	16 Kbytes	t <sub>E16K</sub>	—	100	240	ms	
	4 Kbytes	t <sub>E4K</sub>	—	30	72	ms	PCLK = 50 MHz N <sub>PEC</sub> > 100
	16 Kbytes	t <sub>E16K</sub>	—	120	288	ms	
Suspend delay time during writing	t <sub>SPD</sub>	—	—	120	μs	Figure 5.24 PCLK = 50 MHz	
First suspend delay time during erasing (in suspend priority mode)	t <sub>SESD1</sub>	—	—	120	μs		
Second suspend delay time during erasing (in suspend priority mode)	t <sub>SESD2</sub>	—	—	1.7	ms		
Suspend delay time during erasing (in erasure priority mode)	t <sub>SEED</sub>	—	—	1.7	ms		

## 5.8 Data Flash (Flash Memory for Data Storage) Characteristics

**Table 5.23 Data Flash (Flash Memory for Data Storage) Characteristics (1)**

Note: Items for which test conditions are not specifically stated in the table below have the same values under conditions 1 to 3.

Condition 1: VCC = PLLVCC = 2.7 to 3.6 V, VSS = PLLVSS = AVSS0 = AVSS = VREFL0 = 0 V  
AVCC0 = AVCC = 3.0 to 3.6 V, VREFH0 = 3.0 V to AVCC0, VREF = 3.0 V to AVCC

Condition 2: VCC = PLLVCC = 2.7 to 3.6 V, VSS = PLLVSS = AVSS0 = AVSS = VREFL0 = 0 V  
AVCC0 = AVCC = 4.0 to 5.5 V, VREFH0 = 4.0 V to AVCC0, VREF = 4.0 V to AVCC

Condition 3: VCC = PLLVCC = 4.0 to 5.5 V, VSS = PLLVSS = AVSS0 = AVSS = VREFL0 = 0 V  
AVCC0 = AVCC = 4.0 to 5.5 V, VREFH0 = 4.0 V to AVCC0, VREF = 4.0 V to AVCC

Temperature range for the programming/erasure operation:

Ta = Topr. Ta is the same under conditions 1 to 3.

Item	Symbol	Min.	Typ.	Max.	Unit	Test Conditions
Rewrite/erase cycle*1	N <sub>DPEC</sub>	30000	—	—	Times	
Data hold time	t <sub>DDRP</sub>	30*2	—	—	Year	Ta = +85C°

Note 1. Definition of rewrite/erase cycle:

The rewrite/erase cycle is the number of erasing for each block. When the rewrite/erase cycle is n times (n = 30000), erasing can be performed n times for each block. For instance, when 128-byte writing is performed 16 times for different addresses in 2-Kbyte block and then the entire block is erased, the rewrite/erase cycle is counted as one. However, writing to the same address for several times as one erasing is not enabled (overwriting is prohibited).

Note 2. The value is obtained from the reliability test.

**Table 5.24 Data Flash (Flash Memory for Data Storage) Characteristics (2)**

Note: Items for which test conditions are not specifically stated in the table below have the same values under conditions 1 to 3.

Condition 1: VCC = PLLVCC = 2.7 to 3.6 V, VSS = PLLVSS = AVSS0 = AVSS = VREFL0 = 0 V  
AVCC0 = AVCC = 3.0 to 3.6 V, VREFH0 = 3.0 V to AVCC0, VREF = 3.0 V to AVCC

Condition 2: VCC = PLLVCC = 2.7 to 3.6 V, VSS = PLLVSS = AVSS0 = AVSS = VREFL0 = 0 V  
AVCC0 = AVCC = 4.0 to 5.5 V, VREFH0 = 4.0 V to AVCC0, VREF = 4.0 V to AVCC

Condition 3: VCC = PLLVCC = 4.0 to 5.5 V, VSS = PLLVSS = AVSS0 = AVSS = VREFL0 = 0 V  
AVCC0 = AVCC = 4.0 to 5.5 V, VREFH0 = 4.0 V to AVCC0, VREF = 4.0 V to AVCC

Temperature range for the programming/erasure operation:

Ta = Topr. Ta is the same under conditions 1 to 3.

Item		Symbol	Min.	Typ.	Max.	Unit	Test Conditions
Programming time	8 bytes	t <sub>DP8</sub>	—	0.4	2	ms	PCLK = 50 MHz
	128 bytes	t <sub>DP128</sub>	—	1	5	ms	
Erasure time	2 Kbytes	t <sub>DE2K</sub>	—	70	250	ms	PCLK = 50 MHz
Blank check time	8 bytes	t <sub>DBC8</sub>	—	—	30	μs	PCLK = 50 MHz
	2 Kbytes	t <sub>DBC2K</sub>	—	—	0.7	ms	
Suspend delay time during writing		t <sub>DSPD</sub>	—	—	120	μs	Figure 5.24 PCLK = 50 MHz
First suspend delay time during erasing (in suspend priority mode)		t <sub>DSESD1</sub>	—	—	120	μs	
Second suspend delay time during erasing (in suspend priority mode)		t <sub>DSESD2</sub>	—	—	1.7	ms	
Suspend delay time during erasing (in erasure priority mode)		t <sub>DSEED</sub>	—	—	1.7	ms	



Figure 5.24 Flash Memory Write/Erase Suspend Timing

# Appendix 1. Package Dimensions

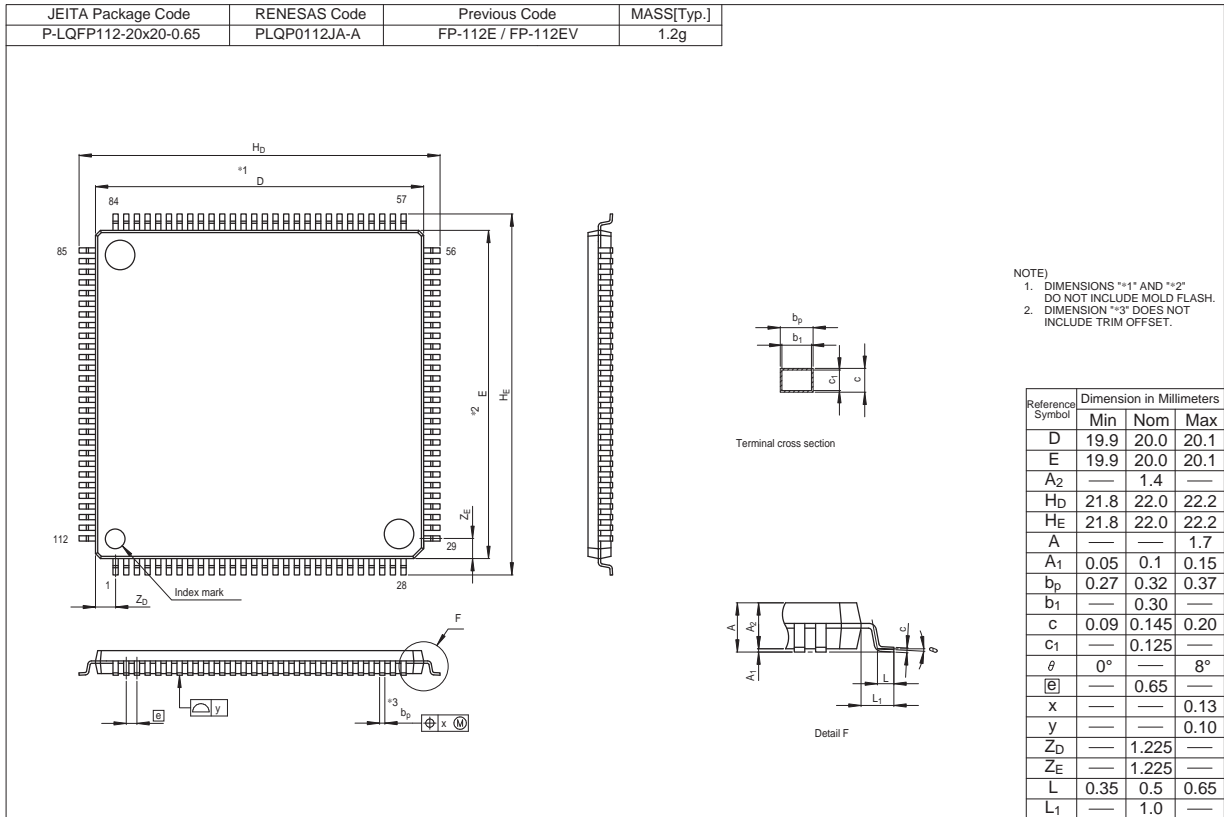

Figure A 112-Pin LQFP (PLQP0112JA-A) Package Dimensions





Figure B 100-Pin LQFP (PLQP0100KB-A) Package Dimensions



Figure C 80-Pin LQFP (PLQP0080JA-A) Package Dimensions



Figure D 64-Pin LQFP (PLQP0064KB-A) Package Dimensions

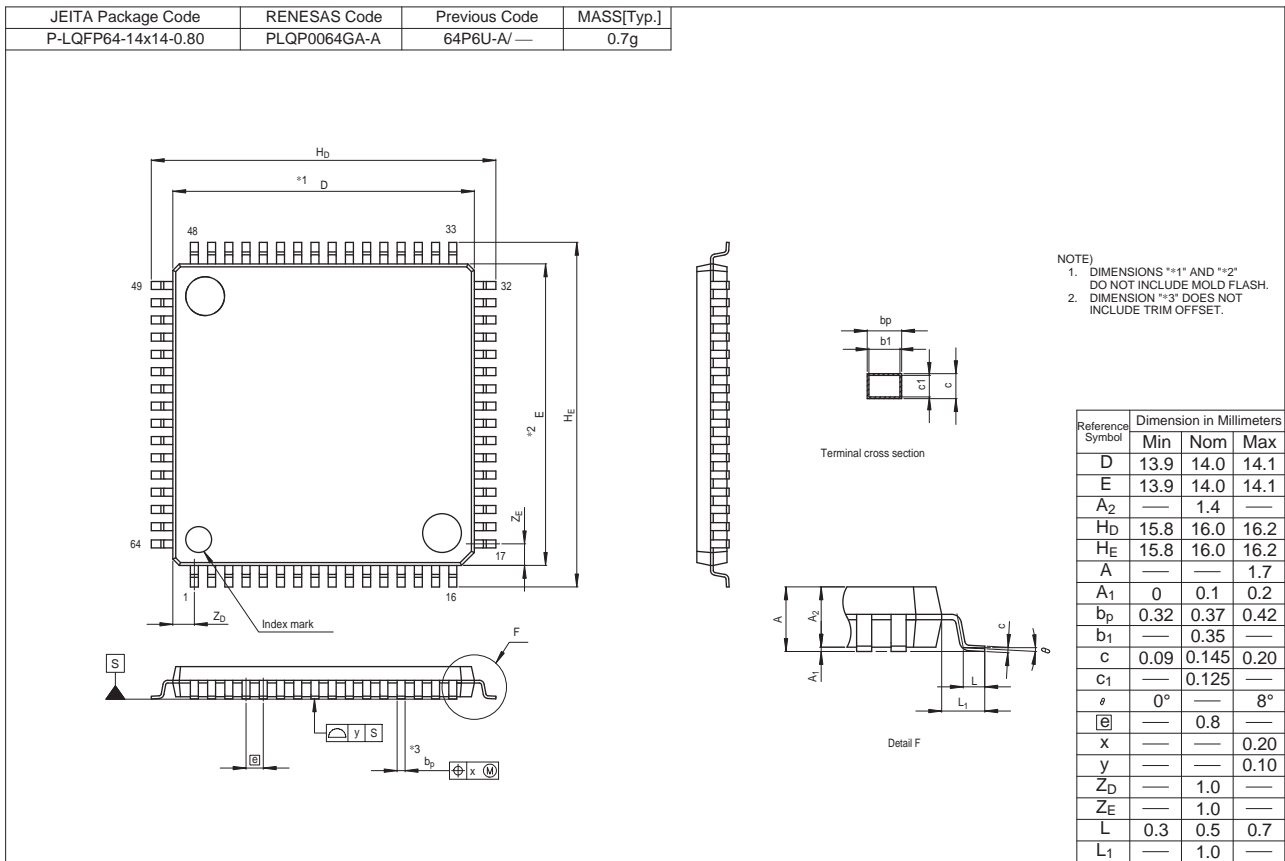

Figure E 64-Pin LQFP (PLQP0064GA-A) Package Dimensions

REVISION HISTORY	RX62T Group, RX62G Group Datasheet
------------------	------------------------------------

Rev.	Date	Description	
		Page	Summary
1.00	Apr 20, 2011	—	First edition issued
1.30	May 22, 2013	1	Features, Package lineup, added
			1. Overview
		2	Table 1.1 Outline of Specifications (1/5) Description of CPU, added
		3	Table 1.1 Outline of Specifications (2/5) Description of Programmable I/O ports, changed
		6	Table 1.1 Outline of Specifications (5/5), 64-pin packaged, added
		7	Table 1.2 Functions of RX62T Group Products, 64-pin package, and MTU3/GPT complementary PWM pins added
		8	Table 1.3 List of Products, 64-pin package part number, changed
		9	Figure 1.1 How to Read the Product Part No., 64-pin package part number, changed
		9	Figure 1.1 How to Read the Product Part No., 5-V version, two-motor control supported, added
		10	Figure 1.2 Block Diagram, changed
		14	Figure 1.6 Pin Assignment of the 80-Pin LQFP (Two-motor Control Supported), added
		15	Figure 1.7 Pin Assignment of the 64-Pin LQFP, Figure PLQP0064GA-A, added
		25 to 27	Table 1.7 List of Pins and Pin Functions (80-Pin LQFP: R5F562TxGDFF) , added
		30 to 33	Table 1.9 Pin Functions, changed
			4. I/O Register
		38 to 61	Table 4.1 List of I/O Registers (Address Order), MPU, added
		47	Table 4.1 List of I/O Registers (Address Order) TMOCNTL, TMOCNTU register, added
57	Table 4.1 List of I/O Registers (Address Order), GTSWP register, added		
	5. Electrical Characteristics		
62	Table 5.1 Absolute Maximum Ratings, note changed		
64	Table 5.2 DC Characteristics (1) (2/3) Test Conditions of P90 to P95, changed		
66	Table 5.3 DC Characteristics (2), note changed		
67	Table 5.4 Permissible Output Currents, note changed		
72	Table 5.7 Control Signal Timing, notes changed		
73	Table 5.8 Timing of On-Chip Peripheral Modules (1), changed		
	Appendix 1. Package Dimensions		
96	Figure E 64-Pin LQFP (PLQP0064GA-A), added		
2.00	Jan 10, 2014	1	Features, changed
			1. Overview
		2 to 6	Table 1.1 Outline of Specifications, changed; Note 1, added
		7, 8	Table 1.2 Functions of RX62T Group and RX62G Group Products, changed
		9, 10	Table 1.3 List of Products, changed; Note 1, added
		11	Figure 1.1 How to Read the Product Part No., changed
		15	Figure 1.6 Pin Assignment of the 80-Pin LQFP (Two-Motor Control Supported Version), added
		27 to 29	Table 1.7 List of Pins and Pin Functions (80-Pin LQFP: R5F562TxGDFF), added
			4. I/O Registers
		43 to 67	Table 4.1 List of I/O Registers (Address Order), changed
68 to 97	Table 4.2 List of I/O Registers (Bit Order), changed		
	5. Electrical Characteristics		
—	Conditions in the table, change to Ta = -40 to +105°C from Ta = -40 to +85°C.		

Rev.	Date	Description	
		Page	Summary
2.00	Jan 10, 2014	98	Table 5.1 Absolute Maximum Ratings, changed
		102	Table 5.3 DC Characteristics (2): Note 3, changed
		103	Table 5.5 Permissible Power Consumption, added
		117	5.3.4 Timing of PWM Delay Generation Circuit, added
		117	Table 5.14 Timing of the PWM Delay Generation Circuit, added
		120	Table 5.17 Characteristics of the Programmable Gain Amplifier, changed
		125	Table 5.21 ROM (Flash Memory for Code Storage) Characteristics (1), changed
		125	Table 5.22 ROM (Flash Memory for Code Storage) Characteristics (2), added
		126	Table 5.23 Data Flash (Flash Memory for Data Storage) Characteristics (1), changed
		126	Table 5.24 Data Flash (Flash Memory for Data Storage) Characteristics (2), added

All trademarks and registered trademarks are the property of their respective owners.

## General Precautions in the Handling of MPU/MCU Products

The following usage notes are applicable to all MPU/MCU products from Renesas. For detailed usage notes on the products covered by this document, refer to the relevant sections of the document as well as any technical updates that have been issued for the products.

### 1. Handling of Unused Pins

Handle unused pins in accordance with the directions given under Handling of Unused Pins in the manual.

- The input pins of CMOS products are generally in the high-impedance state. In operation with an unused pin in the open-circuit state, extra electromagnetic noise is induced in the vicinity of LSI, an associated shoot-through current flows internally, and malfunctions occur due to the false recognition of the pin state as an input signal become possible. Unused pins should be handled as described under Handling of Unused Pins in the manual.

### 2. Processing at Power-on

The state of the product is undefined at the moment when power is supplied.

- The states of internal circuits in the LSI are indeterminate and the states of register settings and pins are undefined at the moment when power is supplied.  
In a finished product where the reset signal is applied to the external reset pin, the states of pins are not guaranteed from the moment when power is supplied until the reset process is completed. In a similar way, the states of pins in a product that is reset by an on-chip power-on reset function are not guaranteed from the moment when power is supplied until the power reaches the level at which resetting has been specified.

### 3. Prohibition of Access to Reserved Addresses

Access to reserved addresses is prohibited.

- The reserved addresses are provided for the possible future expansion of functions. Do not access these addresses; the correct operation of LSI is not guaranteed if they are accessed.

### 4. Clock Signals

After applying a reset, only release the reset line after the operating clock signal has become stable. When switching the clock signal during program execution, wait until the target clock signal has stabilized.

- When the clock signal is generated with an external resonator (or from an external oscillator) during a reset, ensure that the reset line is only released after full stabilization of the clock signal. Moreover, when switching to a clock signal produced with an external resonator (or by an external oscillator) while program execution is in progress, wait until the target clock signal is stable.

### 5. Differences between Products

Before changing from one product to another, i.e. to a product with a different part number, confirm that the change will not lead to problems.

- The characteristics of an MPU or MCU in the same group but having a different part number may differ in terms of the internal memory capacity, layout pattern, and other factors, which can affect the ranges of electrical characteristics, such as characteristic values, operating margins, immunity to noise, and amount of radiated noise. When changing to a product with a different part number, implement a system-evaluation test for the given product.

## Notice

1. Descriptions of circuits, software and other related information in this document are provided only to illustrate the operation of semiconductor products and application examples. You are fully responsible for the incorporation of these circuits, software, and information in the design of your equipment. Renesas Electronics assumes no responsibility for any losses incurred by you or third parties arising from the use of these circuits, software, or information.
2. Renesas Electronics has used reasonable care in preparing the information included in this document, but Renesas Electronics does not warrant that such information is error free. Renesas Electronics assumes no liability whatsoever for any damages incurred by you resulting from errors in or omissions from the information included herein.
3. Renesas Electronics does not assume any liability for infringement of patents, copyrights, or other intellectual property rights of third parties by or arising from the use of Renesas Electronics products or technical information described in this document. No license, express, implied or otherwise, is granted hereby under any patents, copyrights or other intellectual property rights of Renesas Electronics or others.
4. You should not alter, modify, copy, or otherwise misappropriate any Renesas Electronics product, whether in whole or in part. Renesas Electronics assumes no responsibility for any losses incurred by you or third parties arising from such alteration, modification, copy or otherwise misappropriation of Renesas Electronics product.
5. Renesas Electronics products are classified according to the following two quality grades: "Standard" and "High Quality". The recommended applications for each Renesas Electronics product depends on the product's quality grade, as indicated below.  
"Standard": Computers; office equipment; communications equipment; test and measurement equipment; audio and visual equipment; home electronic appliances; machine tools; personal electronic equipment; and industrial robots etc.  
"High Quality": Transportation equipment (automobiles, trains, ships, etc.); traffic control systems; anti-disaster systems; anti-crime systems; and safety equipment etc.  
Renesas Electronics products are neither intended nor authorized for use in products or systems that may pose a direct threat to human life or bodily injury (artificial life support devices or systems, surgical implantations etc.), or may cause serious property damages (nuclear reactor control systems, military equipment etc.). You must check the quality grade of each Renesas Electronics product before using it in a particular application. You may not use any Renesas Electronics product for any application for which it is not intended. Renesas Electronics shall not be in any way liable for any damages or losses incurred by you or third parties arising from the use of any Renesas Electronics product for which the product is not intended by Renesas Electronics.
6. You should use the Renesas Electronics products described in this document within the range specified by Renesas Electronics, especially with respect to the maximum rating, operating supply voltage range, movement power voltage range, heat radiation characteristics, installation and other product characteristics. Renesas Electronics shall have no liability for malfunctions or damages arising out of the use of Renesas Electronics products beyond such specified ranges.
7. Although Renesas Electronics endeavors to improve the quality and reliability of its products, semiconductor products have specific characteristics such as the occurrence of failure at a certain rate and malfunctions under certain use conditions. Further, Renesas Electronics products are not subject to radiation resistance design. Please be sure to implement safety measures to guard them against the possibility of physical injury, and injury or damage caused by fire in the event of the failure of a Renesas Electronics product, such as safety design for hardware and software including but not limited to redundancy, fire control and malfunction prevention, appropriate treatment for aging degradation or any other appropriate measures. Because the evaluation of microcomputer software alone is very difficult, please evaluate the safety of the final products or systems manufactured by you.
8. Please contact a Renesas Electronics sales office for details as to environmental matters such as the environmental compatibility of each Renesas Electronics product. Please use Renesas Electronics products in compliance with all applicable laws and regulations that regulate the inclusion or use of controlled substances, including without limitation, the EU RoHS Directive. Renesas Electronics assumes no liability for damages or losses occurring as a result of your noncompliance with applicable laws and regulations.
9. Renesas Electronics products and technology may not be used for or incorporated into any products or systems whose manufacture, use, or sale is prohibited under any applicable domestic or foreign laws or regulations. You should not use Renesas Electronics products or technology described in this document for any purpose relating to military applications or use by the military, including but not limited to the development of weapons of mass destruction. When exporting the Renesas Electronics products or technology described in this document, you should comply with the applicable export control laws and regulations and follow the procedures required by such laws and regulations.
10. It is the responsibility of the buyer or distributor of Renesas Electronics products, who distributes, disposes of, or otherwise places the product with a third party, to notify such third party in advance of the contents and conditions set forth in this document, Renesas Electronics assumes no responsibility for any losses incurred by you or third parties as a result of unauthorized use of Renesas Electronics products.
11. This document may not be reproduced or duplicated in any form, in whole or in part, without prior written consent of Renesas Electronics.
12. Please contact a Renesas Electronics sales office if you have any questions regarding the information contained in this document or Renesas Electronics products, or if you have any other inquiries.  
(Note 1) "Renesas Electronics" as used in this document means Renesas Electronics Corporation and also includes its majority-owned subsidiaries.  
(Note 2) "Renesas Electronics product(s)" means any product developed or manufactured by or for Renesas Electronics.



### SALES OFFICES

Renesas Electronics Corporation

<http://www.renesas.com>

Refer to "<http://www.renesas.com/>" for the latest and detailed information.

**Renesas Electronics America Inc.**  
2880 Scott Boulevard Santa Clara, CA 95050-2554, U.S.A.  
Tel: +1-408-588-6000, Fax: +1-408-588-6130

**Renesas Electronics Canada Limited**  
1101 Nicholson Road, Newmarket, Ontario L3Y 9C3, Canada  
Tel: +1-905-898-5441, Fax: +1-905-898-3220

**Renesas Electronics Europe Limited**  
Dukes Meadow, Millboard Road, Bourne End, Buckinghamshire, SL8 5FH, U.K.  
Tel: +44-1628-651-700, Fax: +44-1628-651-804

**Renesas Electronics Europe GmbH**  
Arcadiastrasse 10, 40472 Düsseldorf, Germany  
Tel: +49-211-65030, Fax: +49-211-6503-1327

**Renesas Electronics (China) Co., Ltd.**  
7th Floor, Quantum Plaza, No.27 ZhiChunLu Haidian District, Beijing 100083, P.R.China  
Tel: +86-10-8235-1155, Fax: +86-10-8235-7679

**Renesas Electronics (Shanghai) Co., Ltd.**  
Unit 301, Tower A, Central Towers, 555 LanGao Rd., Putuo District, Shanghai, China  
Tel: +86-21-2226-0888, Fax: +86-21-2226-0999

**Renesas Electronics Hong Kong Limited**  
Unit 1601-1613, 16/F., Tower 2, Grand Century Place, 193 Prince Edward Road West, Mongkok, Kowloon, Hong Kong  
Tel: +852-2886-9318, Fax: +852-2886-9022/9044

**Renesas Electronics Taiwan Co., Ltd.**  
13F, No. 363, Fu Shing North Road, Taipei, Taiwan  
Tel: +886-2-8175-9600, Fax: +886-2-8175-9670

**Renesas Electronics Singapore Pte. Ltd.**  
80 Bendemeer Road, Unit #06-02 Hyflux Innovation Centre Singapore 339949  
Tel: +65-6213-0200, Fax: +65-6213-0300

**Renesas Electronics Malaysia Sdn.Bhd.**  
Unit 906, Block B, Menara Amcorp, Amcorp Trade Centre, No. 18, Jin Persiaran Barat, 46050 Petaling Jaya, Selangor Darul Ehsan, Malaysia  
Tel: +60-3-7955-9390, Fax: +60-3-7955-9510

**Renesas Electronics Korea Co., Ltd.**  
12F., 234 Teheran-ro, Gangnam-Gu, Seoul, 135-080, Korea  
Tel: +82-2-558-3737, Fax: +82-2-558-5141



# Mouser Electronics

Authorized Distributor

Click to View Pricing, Inventory, Delivery & Lifecycle Information:

## Renesas Electronics:

[R5F562G7DDFH#V1](#) [R5F562G7DDFP#V1](#) [R5F562T6DDFK#V3](#) [R5F562T7BDFM#V1](#) [R5F562T6DDFF#V3](#)  
[R5F562GADDFH#V3](#) [R5F562TAADFH#V3](#) [R5F562TAEDFK#V3](#) [R5F562TABDFK#V3](#) [R5F562TADDFM#V1](#)  
[R5F562TADDFM#V3](#) [R5F562TAEDFF#V1](#) [R5F562TABDFP#V3](#) [R5F562TADDF#V3](#) [R5F562TAADFF#V3](#)  
[R5F562TABDFM#V3](#) [R5F562TAEDFH#V3](#) [R5F562T7DDFM#V3](#) [R5F562T7EDFK#V3](#) [R5F562GAADFP#V3](#)  
[R5F562T7DDFK#V1](#) [R5F562TAADFP#V3](#) [R5F562T7DDFH#V1](#) [R5F562T7EDFP#V1](#) [R5F562T6BDFF#V1](#)  
[R5F562T6DDFF#V1](#) [R5F562T7EDFK#V1](#) [R5F562TADDF#V1](#) [R5F562TAEDFP#V3](#) [R5F562TADDFH#V1](#)  
[R5F562TAADFK#V1](#) [R5F562TAADFM#V1](#) [R5F562T7DDFF#V1](#) [R5F562T7BDFH#V1](#) [R5F562GAADFP#V1](#)  
[R5F562T6ADFM#V1](#) [R5F562TAEDFH#V1](#) [R5F562T7ADFH#V1](#) [R5F562T7DDFP#V1](#) [R5F562TAADFF#V1](#)  
[R5F562TADDFK#V3](#) [R5F562TAEDFF#V3](#) [R5F562T7ADFP#V1](#) [R5F562T7BDFF#V1](#) [R5F562T7BDFH#V3](#)  
[R5F562T7EDFM#V1](#) [R5F562T6EDFK#V1](#) [R5F562TADDFH#V3](#) [R5F562T7DDFK#V3](#) [R5F562T7DDFM#V1](#)  
[R5F562T6ADFF#V3](#) [R5F562T6ADFK#V1](#) [R5F562T6EDFF#V1](#) [R5F562T7ADFM#V3](#) [R5F562T6ADFM#V3](#)  
[R5F562TAADFK#V3](#) [R5F562T6EDFF#V3](#) [R5F562TABDFH#V1](#) [R5F562TABDFM#V1](#) [R5F562T7BDFP#V1](#)  
[R5F562T7ADFH#V3](#) [R5F562TABDFF#V1](#) [R5F562T7EDFP#V3](#) [R5F562TABDFF#V3](#) [R5F562TAEDFM#V1](#)  
[R5F562T7EDFM#V3](#) [R5F562TABDFK#V1](#) [R5F562T6EDFM#V1](#) [R5F562TAADFM#V3](#) [R5F562T7BDFF#V3](#)  
[R5F562T7DDFP#V3](#) [R5F562T7ADFF#V1](#) [R5F562TABDFH#V3](#) [R5F562T6BDFK#V3](#) [R5F562T7ADFM#V1](#)  
[R5F562T6BDFM#V1](#) [R5F562T6EDFK#V3](#) [R5F562T7EDFF#V3](#) [R5F562GADDFP#V3](#) [R5F562TAADFH#V1](#)  
[R5F562TAADFP#V1](#) [R5F562T7EDFH#V1](#) [R5F562T7BDFK#V1](#) [R5F562T7DDFF#V3](#) [R5F562T6DDFM#V1](#)  
[R5F562T6EDFM#V3](#) [R5F562T6BDFF#V3](#) [R5F562T7ADFK#V3](#) [R5F562G7ADFH#V3](#) [R5F562GADDFH#V1](#)  
[R5F562T6DDFM#V3](#) [R5F562T7BDFK#V3](#) [R5F562T7DDFH#V3](#) [R5F562T7BDFP#V3](#) [R5F562T6ADFK#V3](#)  
[R5F562G7DDFH#V3](#) [R5F562G7DDFP#V3](#) [R5F562T6BDFM#V3](#) [R5F562GAADFH#V3](#) [R5F562GADDFP#V1](#)

Компания «Океан Электроники» предлагает заключение долгосрочных отношений при поставках импортных электронных компонентов на взаимовыгодных условиях!

Наши преимущества:

- Поставка оригинальных импортных электронных компонентов напрямую с производств Америки, Европы и Азии, а так же с крупнейших складов мира;
- Широкая линейка поставок активных и пассивных импортных электронных компонентов (более 30 млн. наименований);
- Поставка сложных, дефицитных, либо снятых с производства позиций;
- Оперативные сроки поставки под заказ (от 5 рабочих дней);
- Экспресс доставка в любую точку России;
- Помощь Конструкторского Отдела и консультации квалифицированных инженеров;
- Техническая поддержка проекта, помощь в подборе аналогов, поставка прототипов;
- Поставка электронных компонентов под контролем ВП;
- Система менеджмента качества сертифицирована по Международному стандарту ISO 9001;
- При необходимости вся продукция военного и аэрокосмического назначения проходит испытания и сертификацию в лаборатории (по согласованию с заказчиком);
- Поставка специализированных компонентов военного и аэрокосмического уровня качества (Xilinx, Altera, Analog Devices, Intersil, Interpoint, Microsemi, Actel, Aeroflex, Peregrine, VPT, Syfer, Eurofarad, Texas Instruments, MS Kennedy, Miteq, Cobham, E2V, MA-COM, Hittite, Mini-Circuits, General Dynamics и др.);

Компания «Океан Электроники» является официальным дистрибьютором и эксклюзивным представителем в России одного из крупнейших производителей разъемов военного и аэрокосмического назначения «JONHON», а так же официальным дистрибьютором и эксклюзивным представителем в России производителя высокотехнологичных и надежных решений для передачи СВЧ сигналов «FORSTAR».



## JONHON

«JONHON» (основан в 1970 г.)

Разъемы специального, военного и аэрокосмического назначения:

(Применяются в военной, авиационной, аэрокосмической, морской, железнодорожной, горно- и нефтедобывающей отраслях промышленности)

«FORSTAR» (основан в 1998 г.)

ВЧ соединители, коаксиальные кабели,  
кабельные сборки и микроволновые компоненты:

(Применяются в телекоммуникациях гражданского и специального назначения, в средствах связи, РЛС, а так же военной, авиационной и аэрокосмической отраслях промышленности).



Телефон: 8 (812) 309-75-97 (многоканальный)

Факс: 8 (812) 320-03-32

Электронная почта: [ocean@oceanchips.ru](mailto:ocean@oceanchips.ru)

Web: <http://oceanchips.ru/>

Адрес: 198099, г. Санкт-Петербург, ул. Калинина, д. 2, корп. 4, лит. А