

50 mA, 100 mA, and 150 mA CMOS LDOs with Shutdown and Error Output

Features

- Low Supply Current (55 μ A Typical) for Longer Battery Life
- Low Dropout Voltage: 140 mV (Typical) @ 150 mA
- High Output Voltage Accuracy: $\pm 0.4\%$ (Typical)
- Standard or Custom Output Voltages
- Power-Saving Shutdown Mode
- $\overline{\text{ERROR}}$ Output Can Be Used as a Low Battery Detector or Processor Reset Generator
- Fast Shutdown Reponse Time: 60 μ s (Typical)
- Overcurrent and Overtemperature Protection
- Space-Saving 5-Pin SOT-23A Package
- Pin Compatible Upgrades for Bipolar Regulators
- Standard Output Voltage Options:
 - 1.8V, 2.5V, 2.6V, 2.7V, 2.8V, 2.85V, 3.0V, 3.3V, 5.0V

Applications

- Battery Operated Systems
- Portable Computers
- Medical Instruments
- Instrumentation
- Cellular / GSMS / PHS Phones
- Pagers

Typical Application

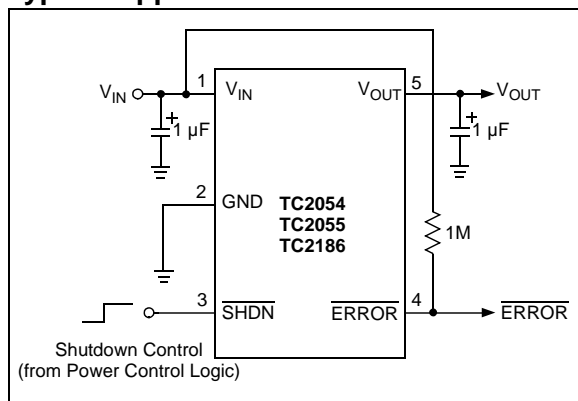

General Description

The TC2054, TC2055 and TC2186 are high accuracy (typically $\pm 0.4\%$) CMOS upgrades for older (bipolar) low dropout regulators. Designed specifically for battery-operated systems, the devices' total supply current is typically 55 μ A at full load (20 to 60 times lower than in bipolar regulators).

The devices' key features include low noise operation, low dropout voltage – typically 45 mV (TC2054); 90 mV (TC2055); and 140 mV (TC2186) at full load - and fast response to step changes in load. An error output ($\overline{\text{ERROR}}$) is asserted when the devices are out-of-regulation (due to a low input voltage or excessive output current). Supply current is reduced to 0.5 μ A (maximum) and both V_{OUT} and $\overline{\text{ERROR}}$ are disabled when the shutdown input is low. The devices also incorporate overcurrent and overtemperature protection.

The TC2054, TC2055 and TC2186 are stable with a low esr ceramic output capacitor of 1 μ F and have a maximum output current of 50 mA, 100 mA and 150 mA, respectively. This LDO Family also features a fast response time (60 μ s typically) when released from shutdown.

Package Type

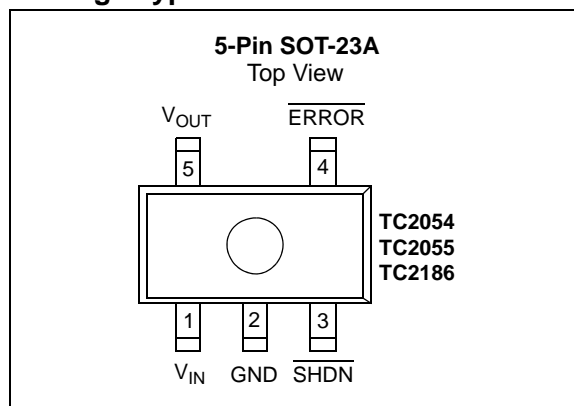

NOTES:

1.0 ELECTRICAL CHARACTERISTICS

Absolute Maximum Ratings †

Input Voltage	6.5V
Output Voltage	(-0.3) to (V _{IN} + 0.3)
Operating Temperature	-40°C < T _J < 125°C
Storage Temperature	-65°C to +150°C
Maximum Voltage on Any Pin	V _{IN} + 0.3V to -0.3V

† **Notice:** Stresses above those listed under “Absolute Maximum Ratings” may cause permanent damage to the device. These are stress ratings only and functional operation of the device at these or any other conditions above those indicated in the operation sections of the specifications is not implied. Exposure to Absolute Maximum Rating conditions for extended periods may affect device reliability.

ELECTRICAL SPECIFICATIONS

Electrical Specifications: Unless otherwise noted, V _{IN} = V _R + 1V, I _L = 100 μA, C _L = 3.3 μF, $\overline{\text{SHDN}} > V_{IH}$, T _A = +25°C. BOLDFACE type specifications apply for junction temperature of -40°C to +125°C.						
Parameter	Sym	Min	Typ	Max	Units	Conditions
Input Operating Voltage	V _{IN}	2.7	—	6.0	V	Note 1
Maximum Output Current	I _{OUTMAX}	50	—	—	mA	TC2054
		100	—	—		TC2055
		150	—	—		TC2186
Output Voltage	V _{OUT}	V _R - 2.0%	V _R ± 0.4%	V _R + 2.0%	V	Note 2
V _{OUT} Temperature Coefficient	TCV _{OUT}	—	20	—	ppm/°C	Note 3
		—	40	—		
Line Regulation	$\frac{\Delta V_{OUT}}{\Delta V_{IN}}$	—	0.05	0.5	%	(V _R + 1V) ≤ V _{IN} ≤ 6V
Load Regulation	$\frac{\Delta V_{OUT}}{V_{OUT}}$	-1.0	0.33	+1.0	%	TC2054; TC2055 I _L = 0.1 mA to I _{OUTMAX}
		-2.0	0.43	+2.0		TC2186 I _L = 0.1 mA to I _{OUTMAX}
		Note 6				
Dropout Voltage, Note 7	V _{IN} - V _{OUT}	—	2	—	mV	I _L = 100 μA
		—	45	70		I _L = 50 mA
		—	90	140		TC2015; TC2185 I _L = 100 mA
		—	140	210		TC2185 I _L = 150 mA
		Note 7				
Supply Current	I _{IN}	—	55	80	μA	$\overline{\text{SHDN}} = V_{IH}$, I _L = 0
Shutdown Supply Current	I _{INSD}	—	0.05	0.5	μA	$\overline{\text{SHDN}} = 0V$
Power Supply Rejection Ratio	PSRR	—	50	—	dB	F _{RE} ≤ 100 kHz
Output Short Circuit Current	I _{OUTSC}	160	300	—	mA	V _{OUT} = 0V

- Note 1:** The minimum V_{IN} has to meet two conditions: V_{IN} = 2.7V and V_{IN} = V_R + V_{DROPOUT}.
- 2:** V_R is the regulator output voltage setting. For example: V_R = 1.8V, 2.7V, 2.8V, 2.85V, 3.0V, 3.3V.
- 3:** TCV_{OUT} = $\frac{(V_{OUTMAX} - V_{OUTMIN}) \times 10^6}{V_{OUT} \times \Delta T}$
- 4:**
- 5:**
- 6:** Regulation is measured at a constant junction temperature using low duty cycle pulse testing. Load regulation is tested over a load range from 1.0 mA to the maximum specified output current. Changes in output voltage due to heating effects are covered by the thermal regulation specification.
- 7:** Dropout voltage is defined as the input to output differential at which the output voltage drops 2% below its nominal value at a 1V differential.
- 8:** Thermal Regulation is defined as the change in output voltage at a time T after a change in power dissipation is applied, excluding load or line regulation effects. Specifications are for a current pulse equal to I_{MAX} at V_{IN} = 6V for T = 10 ms.
- 9:** The maximum allowable power dissipation is a function of ambient temperature, the maximum allowable junction temperature and the thermal resistance from junction-to-air (i.e. T_A, T_J, θ_{JA}).
- 10:** Hysteresis voltage is referenced by V_R.
- 11:** Time required for V_{OUT} to reach 95% of V_R (output voltage setting), after V_{SHDN} is switched from 0 to V_{IN}.

TC2054/2055/2186

ELECTRICAL SPECIFICATIONS (CONTINUED)

Electrical Specifications: Unless otherwise noted, $V_{IN} = V_R + 1V$, $I_L = 100 \mu A$, $C_L = 3.3 \mu F$, $\overline{SHDN} > V_{IH}$, $T_A = +25^\circ C$. BOLDFACE type specifications apply for junction temperature of $-40^\circ C$ to $+125^\circ C$.						
Parameter	Sym	Min	Typ	Max	Units	Conditions
Thermal Regulation	$\Delta V_{OUT}/\Delta P_D$	—	0.04	—	V/W	Note 8
Thermal Shutdown Die Temperature	T_{SD}	—	160	—	$^\circ C$	
Output Noise	eN	—	600	—	nV/ \sqrt{Hz}	$I_L = I_{OUTMAX}$, $F = 10 \text{ kHz}$
Response Time (from Shutdown Mode)	t_R	—	60	—	μs	$V_{IN} = 4V$ $C_{IN} = 1 \mu F$, $C_{OUT} = 10 \mu F$ $I_L = 0.1 \text{ mA}$, Note 11
SHDN Input						
SHDN Input High Threshold	V_{IH}	60	—	—	% V_{IN}	$V_{IN} = 2.5V$ to $6.0V$
SHDN Input Low Threshold	V_{IL}	—	—	15	% V_{IN}	$V_{IN} = 2.5V$ to $6.0V$
ERROR OUTPUT						
Minimum V_{IN} Operating Voltage	V_{INMIN}	1.0	—	—	V	$I_{OL} = 0.1 \text{ mA}$
Output Logic Low Voltage	V_{OL}	—	—	400	mV	1 mA Flows to \overline{ERROR} , $I_{OL} = 1 \text{ mA}$, $V_{IN} = 2V$
ERROR Threshold Voltage	V_{TH}	—	$0.95 \times V_R$	—	V	See Figure 4-2
ERROR Positive Hysteresis	V_{HYS}	—	50	—	mV	Note 10
V_{OUT} to \overline{ERROR} Delay	t_{DELAY}	—	2	—	ms	V_{OUT} from $V_R = 3V$ to $2.8V$
Resistance from \overline{ERROR} to GND	R_{ERROR}	—	126	—	Ω	$V_{DD} = 2.5V$, $V_{OUT} = 2.5V$

- Note 1:** The minimum V_{IN} has to meet two conditions: $V_{IN} = 2.7V$ and $V_{IN} = V_R + V_{DROPOUT}$.
- 2:** V_R is the regulator output voltage setting. For example: $V_R = 1.8V, 2.7V, 2.8V, 2.85V, 3.0V, 3.3V$.
- 3:** $TCV_{OUT} = \frac{(V_{OUTMAX} - V_{OUTMIN}) \times 10^6}{V_{OUT} \times \Delta T}$
- 4:**
- 5:**
- 6:** Regulation is measured at a constant junction temperature using low duty cycle pulse testing. Load regulation is tested over a load range from 1.0 mA to the maximum specified output current. Changes in output voltage due to heating effects are covered by the thermal regulation specification.
- 7:** Dropout voltage is defined as the input to output differential at which the output voltage drops 2% below its nominal value at a 1V differential.
- 8:** Thermal Regulation is defined as the change in output voltage at a time T after a change in power dissipation is applied, excluding load or line regulation effects. Specifications are for a current pulse equal to I_{MAX} at $V_{IN} = 6V$ for $T = 10 \text{ ms}$.
- 9:** The maximum allowable power dissipation is a function of ambient temperature, the maximum allowable junction temperature and the thermal resistance from junction-to-air (i.e. T_A, T_J, θ_{JA}).
- 10:** Hysteresis voltage is referenced by V_R .
- 11:** Time required for V_{OUT} to reach 95% of V_R (output voltage setting), after V_{SHDN} is switched from 0 to V_{IN} .

TEMPERATURE CHARACTERISTICS

Electrical Specifications: Unless otherwise noted, $V_{DD} = +2.7V$ to $+6.0V$ and $V_{SS} = GND$.						
Parameters	Sym	Min	Typ	Max	Units	Conditions
Temperature Ranges:						
Extended Temperature Range	T_A	-40	—	+125	$^\circ C$	
Operating Temperature Range	T_A	-40	—	+125	$^\circ C$	
Storage Temperature Range	T_A	-65	—	+150	$^\circ C$	
Thermal Package Resistances:						
Thermal Resistance, 5L-SOT-23	θ_{JA}	—	255	—	$^\circ C/W$	

2.0 TYPICAL PERFORMANCE CURVES

Note: The graphs and tables provided following this note are a statistical summary based on a limited number of samples and are provided for informational purposes only. The performance characteristics listed herein are not tested or guaranteed. In some graphs or tables, the data presented may be outside the specified operating range (e.g., outside specified power supply range) and therefore outside the warranted range.

Note: Unless otherwise indicated, $V_{IN} = V_R + 1V$, $I_L = 100 \mu A$, $C_{OUT} = 3.3 \mu F$, $\overline{SHDN} > V_{IH}$, $T_A = +25^\circ C$.

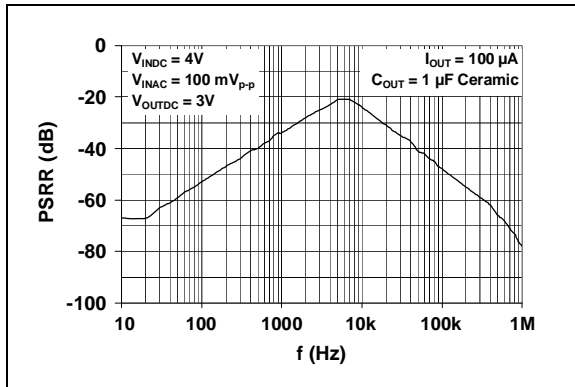

FIGURE 2-1: Power Supply Rejection Ratio.

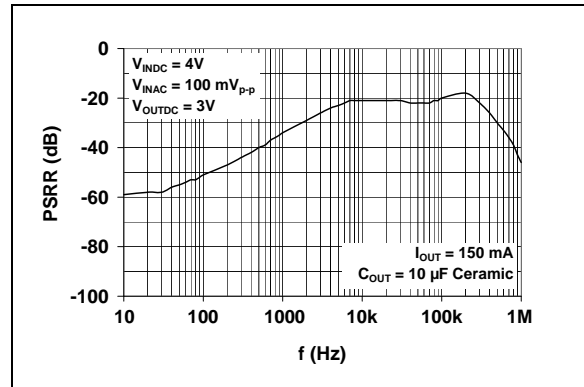

FIGURE 2-4: Power Supply Rejection Ratio.

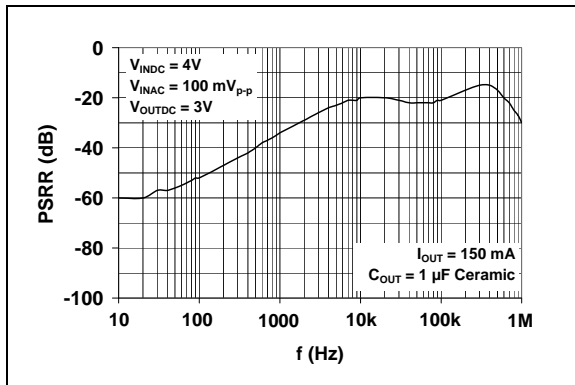

FIGURE 2-2: Power Supply Rejection Ratio.

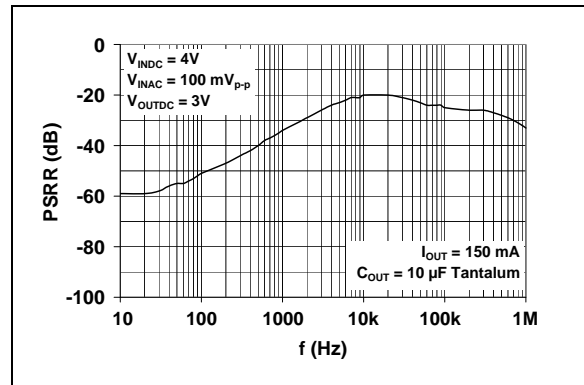

FIGURE 2-5: Power Supply Rejection Ratio.

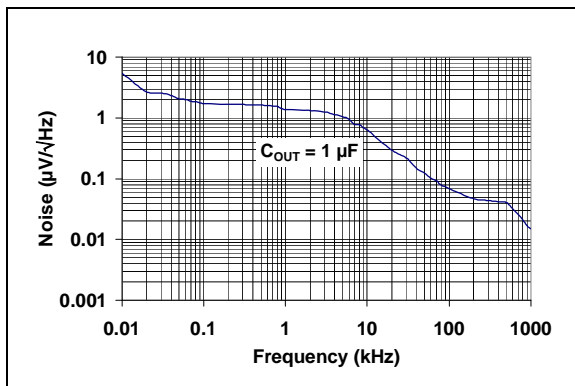

FIGURE 2-3: Output Noise vs. Frequency.

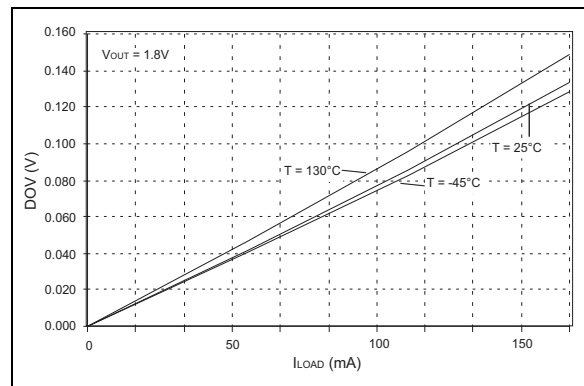

FIGURE 2-6: Dropout Voltage vs. I_{LOAD} .

TC2054/2055/2186

Note: Unless otherwise indicated, $V_{IN} = V_R + 1V$, $I_L = 100 \mu A$, $C_{OUT} = 3.3 \mu F$, $\overline{SHDN} > V_{IH}$, $T_A = +25^\circ C$.

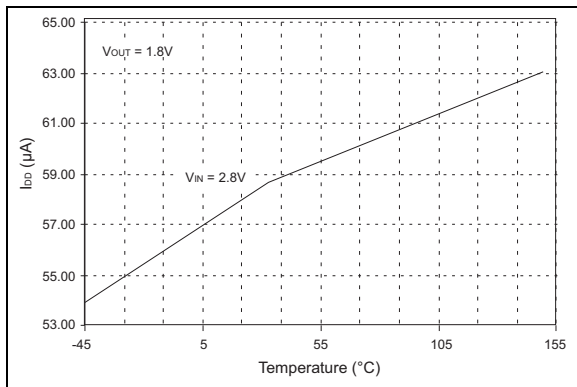

FIGURE 2-7: I_{DD} vs. Temperature.

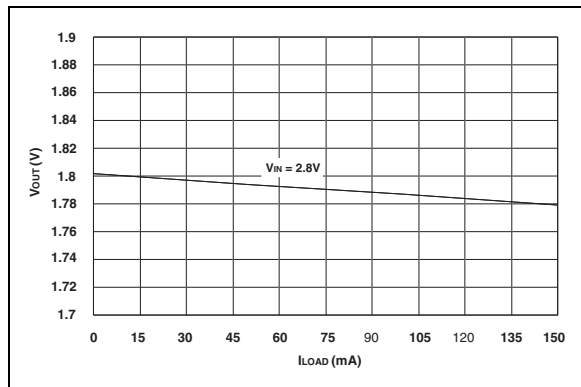

FIGURE 2-10: Output Voltage vs. Output Current.

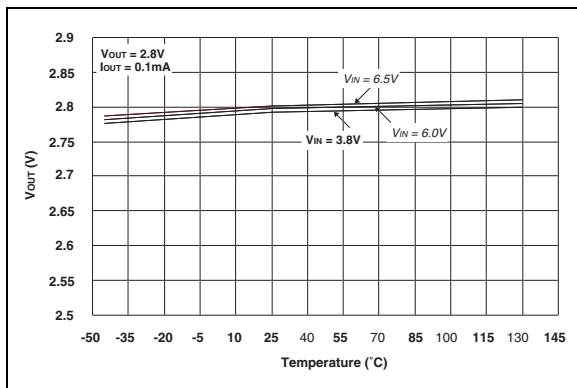

FIGURE 2-8: Output Voltage vs. Temperature.

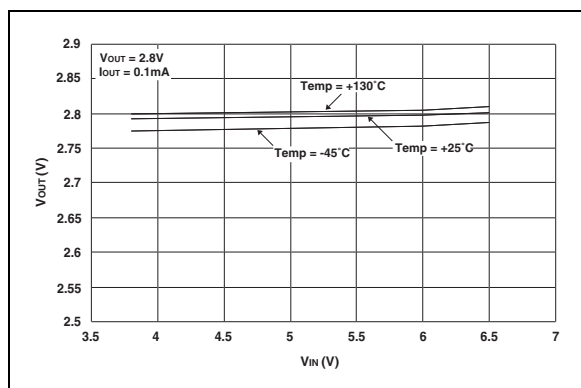

FIGURE 2-11: Output Voltage vs. Supply Voltage.

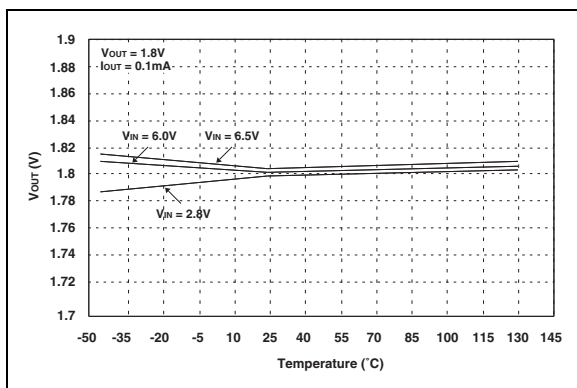

FIGURE 2-9: Output Voltage vs. Temperature.

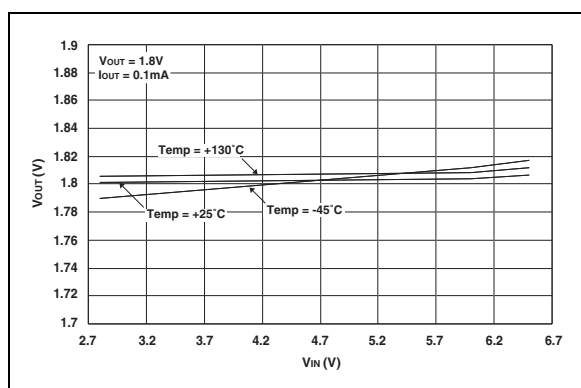

FIGURE 2-12: Dropout Voltage vs. Supply Voltage.

Note: Unless otherwise indicated, $V_{IN} = V_R + 1V$, $I_L = 100 \mu A$, $C_{OUT} = 3.3 \mu F$, $\overline{SHDN} > V_{IH}$, $T_A = +25^\circ C$.

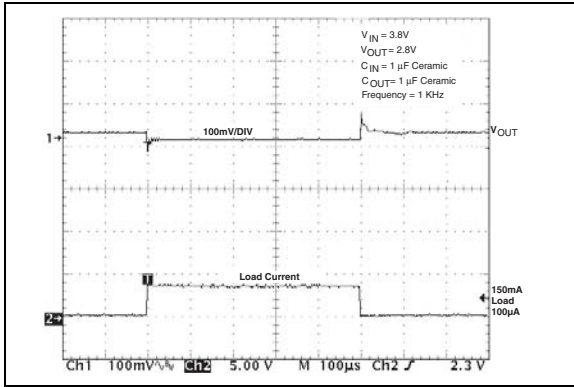

FIGURE 2-13: Load Transient Response.

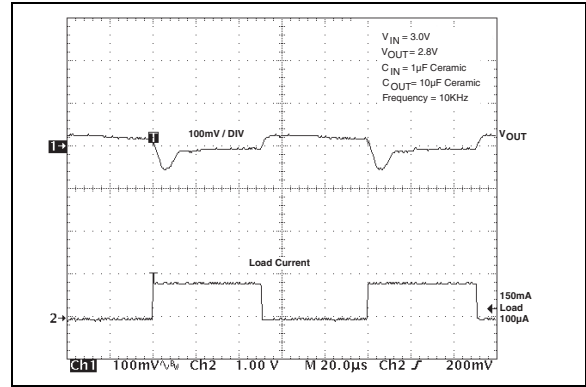

FIGURE 2-16: Load Transient Response.

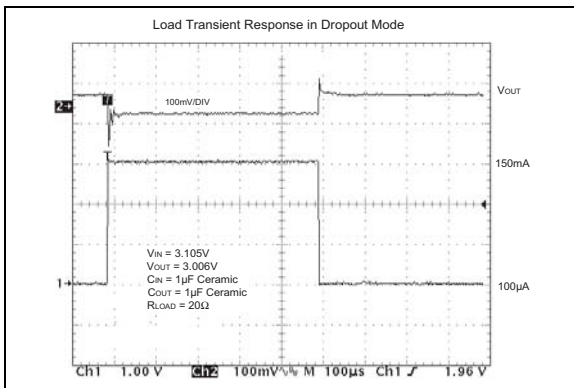

FIGURE 2-14: Load Transient Response in Dropout Mode.

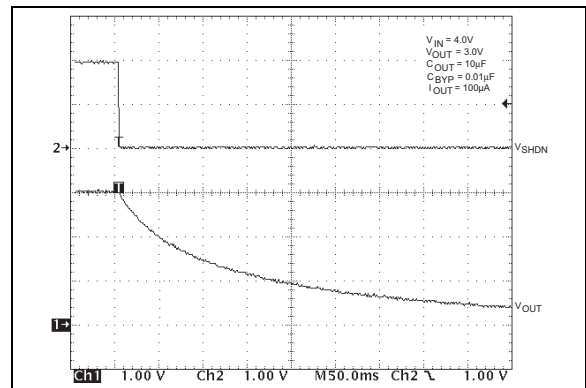

FIGURE 2-17: Shutdown Delay.

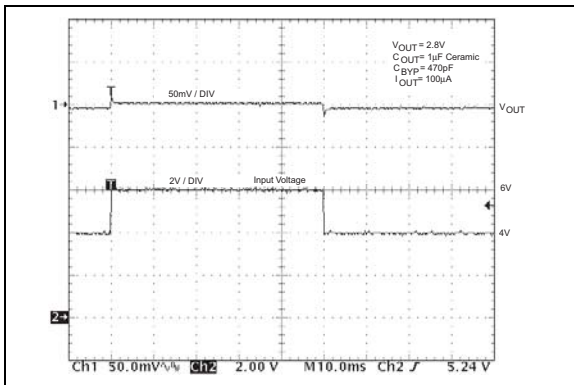

FIGURE 2-15: Line Transient Response.

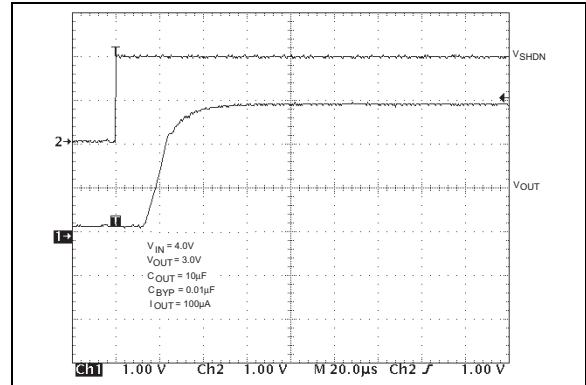

FIGURE 2-18: Shutdown Wake-up Time.

TC2054/2055/2186

Note: Unless otherwise indicated, $V_{IN} = V_R + 1V$, $I_L = 100 \mu A$, $C_{OUT} = 3.3 \mu F$, $\overline{SHDN} > V_{IH}$, $T_A = +25^\circ C$.

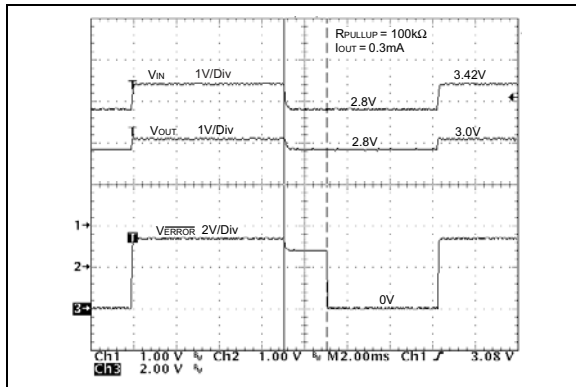

FIGURE 2-19: V_{OUT} to $ERROR$ Delay.

3.0 PIN DESCRIPTIONS

The descriptions of the pins are listed in [Table 3-1](#).

TABLE 3-1: PIN FUNCTION TABLE

Pin Number	Symbol	Description
1	V_{IN}	Unregulated supply input.
2	GND	Ground terminal.
3	$\overline{\text{SHDN}}$	Shutdown control input. The regulator is fully enabled when a logic high is applied to this input. The regulator enters shutdown when a logic low is applied to this input. During shutdown, output voltage falls to zero, ERROR is open circuited and supply current is reduced to 0.5 μA (maximum).
4	$\overline{\text{ERROR}}$	Out-of-Regulation Flag. (Open-drain output). This output goes low when V_{OUT} is out-of-tolerance by approximately -5%.
5	V_{OUT}	Regulated voltage output.

3.1 Unregulated Supply Input (V_{IN})

Connect the unregulated input supply to the V_{IN} pin. If there is a large distance between the input supply and the LDO regulator, some input capacitance is necessary for proper operation. A 1 μF capacitor, connected from V_{IN} to ground, is recommended for most applications.

3.2 Ground Terminal (GND)

Connect the unregulated input supply ground return to GND. Also connect one side of the 1 μF typical input decoupling capacitor close to this pin and one side of the output capacitor C_{OUT} to this pin.

3.3 Shutdown Control Input ($\overline{\text{SHDN}}$)

The regulator is fully enabled when a logic-high is applied to $\overline{\text{SHDN}}$. The regulator enters shutdown when a logic-low is applied to this input. During shutdown, the output voltage falls to zero and the supply current is reduced to 0.5 μA (maximum).

3.4 Out-of-Regulation Flag ($\overline{\text{ERROR}}$)

The open-drain $\overline{\text{ERROR}}$ flag provides indication that the regulator output voltage is not in regulation. The ERROR pin will be low when the output is typically below 5% of its specified value.

3.5 Regulated Voltage Output (V_{OUT})

Connect the output load to V_{OUT} of the LDO. Also connect one side of the LDO output decoupling capacitor as close as possible to the V_{OUT} pin.

NOTES:

4.0 DETAILED DESCRIPTION

The TC2054, TC2055 and TC2186 are precision fixed output voltage regulators. (If an adjustable version is desired, refer to the TC1070/TC1071/TC1187 data sheet (DS21353). Unlike bipolar regulators, the TC2054, TC2055 and TC2186 supply current does not increase with load current. In addition, V_{OUT} remains stable and within regulation over the entire 0 mA to maximum output current operating load range.

Figure 4-1 shows a typical application circuit. The regulator is enabled any time the shutdown input (SHDN) is at or above V_{IH} , and shutdown (disabled) when SHDN is at or below V_{IL} . SHDN may be controlled by a CMOS logic gate, or I/O port of a microcontroller. If the SHDN input is not required, it should be connected directly to the input supply. While in shutdown, supply current decreases to 0.05 μ A (typical), V_{OUT} falls to zero volts, and ERROR is open-circuited.

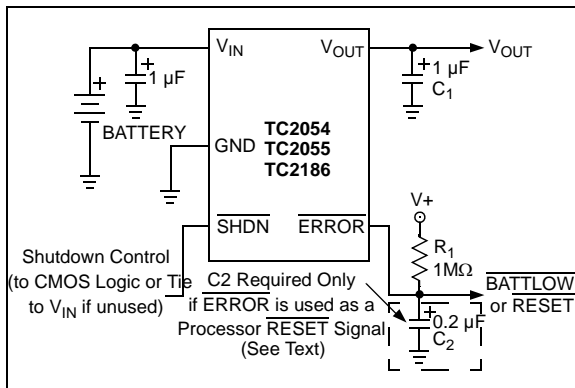

FIGURE 4-1: Typical Application Circuit.

4.1 ERROR Open-Drain Output

ERROR is driven low whenever V_{OUT} falls out of regulation by more than -5% (typical). This condition may be caused by low input voltage, output current limiting or thermal limiting. The ERROR threshold is 5% below rated V_{OUT} regardless of the programmed output voltage value (e.g. ERROR = V_{OL} at 4.75V (typical) for a 5.0V regulator and 2.85V (typical) for a 3.0V regulator). ERROR output operation is shown in Figure 4-2.

Note that ERROR is active when V_{OUT} falls to V_{TH} , and inactive when V_{OUT} rises above V_{TH} by V_{HYS} .

As shown in Figure 4-1, ERROR can be used as a battery low flag or as a processor RESET signal (with the addition of timing capacitor C_2). $R_1 \times C_2$ should be chosen to maintain ERROR below V_{IH} of the processor RESET input for at least 200 ms to allow time for the system to stabilize. Pull-up resistor R_1 can be tied to V_{OUT} , V_{IN} or any other voltage less than $(V_{IN} + 0.3V)$. The ERROR pin sink current is self-limiting to approximately 18 mA.

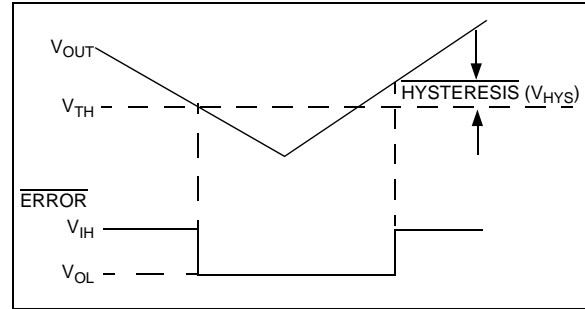

FIGURE 4-2: Error Output Operation.

4.2 Output Capacitor

A 1 μ F (minimum) capacitor from V_{OUT} to ground is required. The output capacitor should have an effective series resistance of 0.01 Ω to 5 Ω for $V_{OUT} = 2.5V$, and 0.05 Ω to 5 Ω for $V_{OUT} < 2.5V$. Ceramic, tantalum and aluminum electrolytic capacitors can be used. (Since many aluminum electrolytic capacitors freeze at approximately -30°C, solid tantalums are recommended for applications operating below -25°C). When operating from sources other than batteries, supply-noise rejection and transient response can be improved by increasing the value of the input and output capacitors and employing passive filtering techniques.

4.3 Input Capacitor

A 1 μ F capacitor should be connected from V_{IN} to GND if there is more than 10 inches of wire between the regulator and this AC filter capacitor, or if a battery is used as the power source. Aluminum electrolytic or tantalum capacitors can be used (since many aluminum electrolytic capacitors freeze at approximately -30°C, solid tantalum are recommended for applications operating below -25°C). When operating from sources other than batteries, supply-noise rejection and transient response can be improved by increasing the value of the input and output capacitors and employing passive filtering techniques.

NOTES:

5.0 THERMAL CONSIDERATIONS

5.1 Thermal Shutdown

Integrated thermal protection circuitry shuts the regulator off when the die temperature exceeds approximately 160°C. The regulator remains off until the die temperature cools to approximately 150°C.

5.2 Power Dissipation

The amount of power the regulator dissipates is primarily a function of input and output voltage, and output current.

Equation 5-1 is used to calculate worst case power dissipation:

EQUATION 5-1:

$$P_D \approx (V_{INMAX} - V_{OUTMIN})I_{LOADMAX}$$

Where:

P_D	=	Worst-case actual power dissipation
V_{INMAX}	=	Maximum voltage on V_{IN}
V_{OUTMIN}	=	Minimum regulator output voltage
$I_{LOADMAX}$	=	Maximum output (load) current

The maximum allowable power dissipation (Equation 5-2) is a function of the maximum ambient temperature (T_{AMAX}), the maximum allowable die temperature (125 °C) and the thermal resistance from junction-to-air (θ_{JA}). The 5-Pin SOT-23A package has a θ_{JA} of approximately 220°C/Watt when mounted on a typical two layer FR4 dielectric copper clad PC board.

EQUATION 5-2:

$$P_{DMAX} = \frac{T_{JMAX} - T_{AMAX}}{\theta_{JA}}$$

Where all terms are previously defined.

Equation 5-1 can be used in conjunction with Equation 5-2 to ensure regulator thermal operation is within limits. For example:

Given:

$$\begin{aligned} V_{INMAX} &= 3.0V + 10\% \\ V_{OUTMIN} &= 2.7V - 2.5\% \\ I_{LOADMAX} &= 40 \text{ mA} \\ T_{AMAX} &= +55^\circ\text{C} \end{aligned}$$

Find:

1. Actual power dissipation
2. Maximum allowable dissipation

Actual power dissipation:

$$\begin{aligned} P_D &= (V_{INMAX} - V_{OUTMIN})I_{LOADMAX} \\ &= [(3.0 \times 1.1) - (2.7 \times 0.975)]40 \times 10^{-3} \\ &= 26.7 \text{ mW} \end{aligned}$$

Maximum allowable power dissipation:

$$\begin{aligned} P_{DMAX} &= \frac{T_{JMAX} - T_{AMAX}}{\theta_{JA}} \\ &= \frac{125 - 55}{220} \\ &= 318 \text{ mW} \end{aligned}$$

In this example, the TC2054 dissipates a maximum of only 26.7 mW; far below the allowable limit of 318 mW. In a similar manner, Equation 5-1 and Equation 5-2 can be used to calculate maximum current and/or input voltage limits.

5.3 Layout Considerations

The primary path of heat conduction out of the package is via the package leads. Therefore, layouts having a ground plane, wide traces at the pads, and wide power supply bus lines combine to lower θ_{JA} and, therefore, increase the maximum allowable power dissipation limit.

NOTES:

6.0 PACKAGING INFORMATION

6.1 Package Marking Information

5-Lead SOT-23

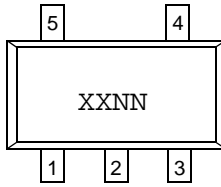
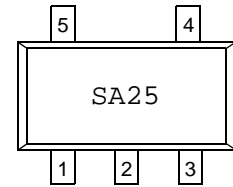

TABLE 6-1: PART NUMBER CODE AND TEMPERATURE RANGE

(V)	TC2054	TC2055	TC2186
1.8	SA	TA	VA
2.5	SB	TB	VB
2.6	SH	TH	VH
2.7	SC	TC	VC
2.8	SD	TD	VD
2.85	SE	TE	VE
3.0	SF	TF	VF
3.3	SG	TG	VG
5.0	SK	TJ	VJ

Example:



Legend: XX...X Customer-specific information
 NN Alphanumeric traceability code

6.2 Taping Information

Component Taping Orientation for 5-Pin SOT-23A (EIAJ SC-74A) Devices

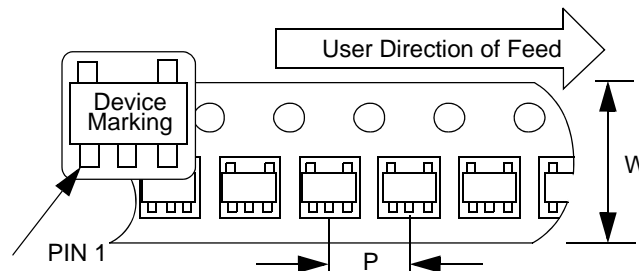

Standard Reel Component Orientation
 for 713 Suffix Device
 (Mark Right Side Up)

Carrier Tape, Number of Components Per Reel and Reel Size:

Package	Carrier Width (W)	Pitch (P)	Part Per Full Reel	Reel Size
5-Pin SOT-23A	8 mm	4 mm	3000	7 in.

TC2054/2055/2186

5-Lead Plastic Small Outline Transistor (CT) [SOT-23]

Note: For the most current package drawings, please see the Microchip Packaging Specification located at <http://www.microchip.com/packaging>

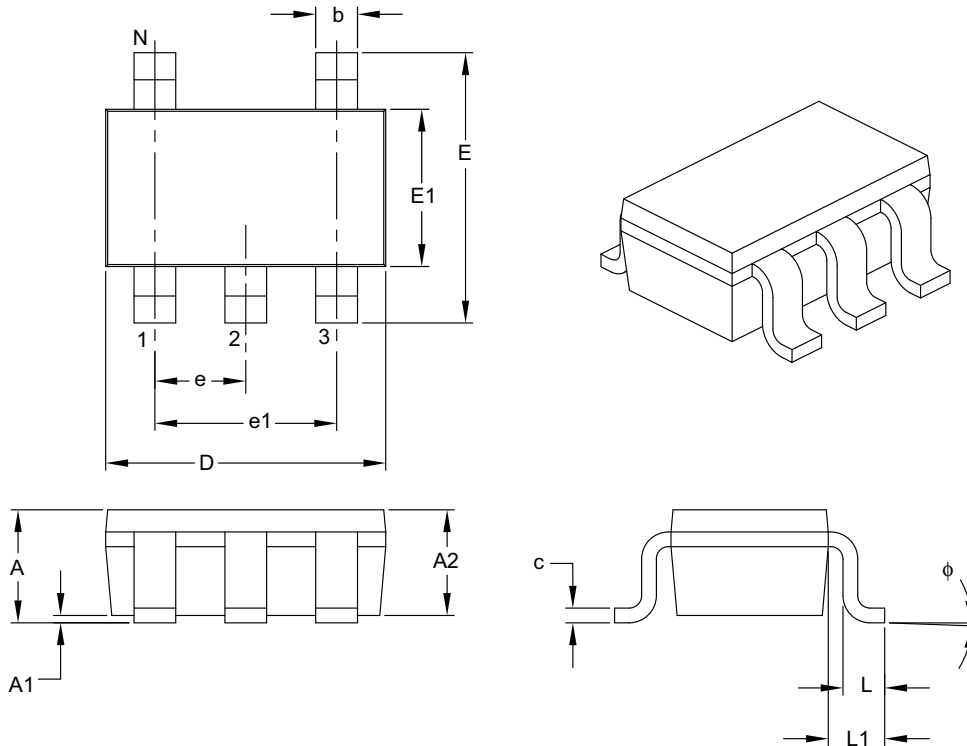

Dimension Limits	Units	MILLIMETERS		
		MIN	NOM	MAX
Number of Pins	N	5		
Lead Pitch	e	0.95 BSC		
Outside Lead Pitch	e1	1.90 BSC		
Overall Height	A	0.90	–	1.45
Molded Package Thickness	A2	0.89	–	1.30
Standoff	A1	0.00	–	0.15
Overall Width	E	2.20	–	3.20
Molded Package Width	E1	1.30	–	1.80
Overall Length	D	2.70	–	3.10
Foot Length	L	0.10	–	0.60
Footprint	L1	0.35	–	0.80
Foot Angle	ϕ	0°	–	30°
Lead Thickness	c	0.08	–	0.26
Lead Width	b	0.20	–	0.51

Notes:

- Dimensions D and E1 do not include mold flash or protrusions. Mold flash or protrusions shall not exceed 0.127 mm per side.
- Dimensioning and tolerancing per ASME Y14.5M.

BSC: Basic Dimension. Theoretically exact value shown without tolerances.

Microchip Technology Drawing C04-091B

APPENDIX A: REVISION HISTORY

Revision D (September 2009)

The following is the list of modifications:

1. Added the 2.6V, and 5.0V option in [Table 6-1](#) in **Section 6.0 “Packaging Information”**.
2. Updated the package outline drawing.
3. Added 2.6V option to **Product Identification System** section.

Revision C (May 2006)

The following is the list of modifications:

1. Added overtemperature to bullet for overcurrent protection in Features and General Description verbiage.
2. Added “Thermal Shutdown Die Temperature” to the Electrical Specifications table. Changed condition for “Minimum V_{IN} Operating Voltage”.
3. Added Temperature Characteristics Table.
4. Added **Section 5.1 “Thermal Shutdown”**.
5. Updated the package outline drawing.

Revision B (May 2002)

- Data Sheet converted to Microchip standards.

Revision A (May 2001)

- Original Release of this Document under Telcom.

NOTES:

PRODUCT IDENTIFICATION SYSTEM

To order or obtain information, e.g., on pricing or delivery, refer to the factory or the listed sales office.

<u>PART NO.</u>	<u>-XX</u>	<u>X</u>	<u>XXXX</u>	
Device	Output Voltage	Temperature Range	Package	
Device:	TC2054:	50 mA LDO with Shutdown and <u>ERROR</u> Output		
	TC2055:	100 mA LDO with Shutdown and <u>ERROR</u> Output		
	TC2186:	150 mA LDO with Shutdown and ERROR Output		
Output Voltage:	XX =	1.8V		
	XX =	2.5V		
	XX =	2.6V		
	XX =	2.7V		
	XX =	2.8V		
	XX =	2.85V		
	XX =	3.0V		
	XX =	3.3V		
	XX =	5.0V		
Temperature Range:	V	= -40°C to +125°C		
Package:	CTTR	= Plastic Small Outline Transistor (SOT-23), 5-lead, Tape and Reel		
Examples:				
a)	TC2054-1.8VCTTR:	5LD SOT-23-A, 1.8V, Tape and Reel.		
b)	TC2054-2.85VCTTR:	5LD SOT-23-A, 2.85V, Tape and Reel.		
c)	TC2054-3.3VCTTR:	5LD SOT-23-A, 3.3V, Tape and Reel.		
a)	TC2055-1.8VCTTR:	5LD SOT-23-A, 1.8V, Tape and Reel.		
b)	TC2055-2.85VCTTR:	5LD SOT-23-A, 2.85V, Tape and Reel.		
c)	TC2055-3.0VCTTR:	5LD SOT-23-A, 3.0V, Tape and Reel.		
a)	TC2186-1.8VCTTR:	5LD SOT-23-A, 1.8V, Tape and Reel.		
b)	TC2186-2.8VCTTR:	5LD SOT-23-A, 2.8V, Tape and Reel.		

NOTES:

Note the following details of the code protection feature on Microchip devices:

- Microchip products meet the specification contained in their particular Microchip Data Sheet.
- Microchip believes that its family of products is one of the most secure families of its kind on the market today, when used in the intended manner and under normal conditions.
- There are dishonest and possibly illegal methods used to breach the code protection feature. All of these methods, to our knowledge, require using the Microchip products in a manner outside the operating specifications contained in Microchip's Data Sheets. Most likely, the person doing so is engaged in theft of intellectual property.
- Microchip is willing to work with the customer who is concerned about the integrity of their code.
- Neither Microchip nor any other semiconductor manufacturer can guarantee the security of their code. Code protection does not mean that we are guaranteeing the product as “unbreakable.”

Code protection is constantly evolving. We at Microchip are committed to continuously improving the code protection features of our products. Attempts to break Microchip's code protection feature may be a violation of the Digital Millennium Copyright Act. If such acts allow unauthorized access to your software or other copyrighted work, you may have a right to sue for relief under that Act.

Information contained in this publication regarding device applications and the like is provided only for your convenience and may be superseded by updates. It is your responsibility to ensure that your application meets with your specifications. MICROCHIP MAKES NO REPRESENTATIONS OR WARRANTIES OF ANY KIND WHETHER EXPRESS OR IMPLIED, WRITTEN OR ORAL, STATUTORY OR OTHERWISE, RELATED TO THE INFORMATION, INCLUDING BUT NOT LIMITED TO ITS CONDITION, QUALITY, PERFORMANCE, MERCHANTABILITY OR FITNESS FOR PURPOSE. Microchip disclaims all liability arising from this information and its use. Use of Microchip devices in life support and/or safety applications is entirely at the buyer's risk, and the buyer agrees to defend, indemnify and hold harmless Microchip from any and all damages, claims, suits, or expenses resulting from such use. No licenses are conveyed, implicitly or otherwise, under any Microchip intellectual property rights.

Trademarks

The Microchip name and logo, the Microchip logo, dsPIC, KEELOQ, KEELOQ logo, MPLAB, PIC, PICmicro, PICSTART, rfPIC and UNI/O are registered trademarks of Microchip Technology Incorporated in the U.S.A. and other countries.

FilterLab, Hampshire, HI-TECH C, Linear Active Thermistor, MXDEV, MXLAB, SEEVAL and The Embedded Control Solutions Company are registered trademarks of Microchip Technology Incorporated in the U.S.A.

Analog-for-the-Digital Age, Application Maestro, CodeGuard, dsPICDEM, dsPICDEM.net, dsPICworks, dsSPEAK, ECAN, ECONOMONITOR, FanSense, HI-TIDE, In-Circuit Serial Programming, ICSP, Mindi, MiWi, MPASM, MPLAB Certified logo, MPLIB, MPLINK, mTouch, Octopus, Omniscient Code Generation, PICC, PICC-18, PICDEM, PICDEM.net, PICkit, PICtail, PIC³² logo, REAL ICE, rFLAB, Select Mode, Total Endurance, TSHARC, UniWinDriver, WiperLock and ZENA are trademarks of Microchip Technology Incorporated in the U.S.A. and other countries.

SQTP is a service mark of Microchip Technology Incorporated in the U.S.A.

All other trademarks mentioned herein are property of their respective companies.

© 2009, Microchip Technology Incorporated, Printed in the U.S.A., All Rights Reserved.

 Printed on recycled paper.

**QUALITY MANAGEMENT SYSTEM
CERTIFIED BY DNV
== ISO/TS 16949:2002 ==**

Microchip received ISO/TS-16949:2002 certification for its worldwide headquarters, design and wafer fabrication facilities in Chandler and Tempe, Arizona; Gresham, Oregon and design centers in California and India. The Company's quality system processes and procedures are for its PIC[®] MCUs and dsPIC[®] DSCs, KEELOQ[®] code hopping devices, Serial EEPROMs, microperipherals, nonvolatile memory and analog products. In addition, Microchip's quality system for the design and manufacture of development systems is ISO 9001:2000 certified.



WORLDWIDE SALES AND SERVICE

AMERICAS

Corporate Office
2355 West Chandler Blvd.
Chandler, AZ 85224-6199
Tel: 480-792-7200
Fax: 480-792-7277
Technical Support:
<http://support.microchip.com>
Web Address:
www.microchip.com

Atlanta
Duluth, GA
Tel: 678-957-9614
Fax: 678-957-1455

Boston
Westborough, MA
Tel: 774-760-0087
Fax: 774-760-0088

Chicago
Itasca, IL
Tel: 630-285-0071
Fax: 630-285-0075

Cleveland
Independence, OH
Tel: 216-447-0464
Fax: 216-447-0643

Dallas
Addison, TX
Tel: 972-818-7423
Fax: 972-818-2924

Detroit
Farmington Hills, MI
Tel: 248-538-2250
Fax: 248-538-2260

Kokomo
Kokomo, IN
Tel: 765-864-8360
Fax: 765-864-8387

Los Angeles
Mission Viejo, CA
Tel: 949-462-9523
Fax: 949-462-9608

Santa Clara
Santa Clara, CA
Tel: 408-961-6444
Fax: 408-961-6445

Toronto
Mississauga, Ontario,
Canada
Tel: 905-673-0699
Fax: 905-673-6509

ASIA/PACIFIC

Asia Pacific Office
Suites 3707-14, 37th Floor
Tower 6, The Gateway
Harbour City, Kowloon
Hong Kong
Tel: 852-2401-1200
Fax: 852-2401-3431

Australia - Sydney
Tel: 61-2-9868-6733
Fax: 61-2-9868-6755

China - Beijing
Tel: 86-10-8528-2100
Fax: 86-10-8528-2104

China - Chengdu
Tel: 86-28-8665-5511
Fax: 86-28-8665-7889

China - Hong Kong SAR
Tel: 852-2401-1200
Fax: 852-2401-3431

China - Nanjing
Tel: 86-25-8473-2460
Fax: 86-25-8473-2470

China - Qingdao
Tel: 86-532-8502-7355
Fax: 86-532-8502-7205

China - Shanghai
Tel: 86-21-5407-5533
Fax: 86-21-5407-5066

China - Shenyang
Tel: 86-24-2334-2829
Fax: 86-24-2334-2393

China - Shenzhen
Tel: 86-755-8203-2660
Fax: 86-755-8203-1760

China - Wuhan
Tel: 86-27-5980-5300
Fax: 86-27-5980-5118

China - Xiamen
Tel: 86-592-2388138
Fax: 86-592-2388130

China - Xian
Tel: 86-29-8833-7252
Fax: 86-29-8833-7256

China - Zhuhai
Tel: 86-756-3210040
Fax: 86-756-3210049

ASIA/PACIFIC

India - Bangalore
Tel: 91-80-3090-4444
Fax: 91-80-3090-4080

India - New Delhi
Tel: 91-11-4160-8631
Fax: 91-11-4160-8632

India - Pune
Tel: 91-20-2566-1512
Fax: 91-20-2566-1513

Japan - Yokohama
Tel: 81-45-471- 6166
Fax: 81-45-471-6122

Korea - Daegu
Tel: 82-53-744-4301
Fax: 82-53-744-4302

Korea - Seoul
Tel: 82-2-554-7200
Fax: 82-2-558-5932 or
82-2-558-5934

Malaysia - Kuala Lumpur
Tel: 60-3-6201-9857
Fax: 60-3-6201-9859

Malaysia - Penang
Tel: 60-4-227-8870
Fax: 60-4-227-4068

Philippines - Manila
Tel: 63-2-634-9065
Fax: 63-2-634-9069

Singapore
Tel: 65-6334-8870
Fax: 65-6334-8850

Taiwan - Hsin Chu
Tel: 886-3-6578-300
Fax: 886-3-6578-370

Taiwan - Kaohsiung
Tel: 886-7-536-4818
Fax: 886-7-536-4803

Taiwan - Taipei
Tel: 886-2-2500-6610
Fax: 886-2-2508-0102

Thailand - Bangkok
Tel: 66-2-694-1351
Fax: 66-2-694-1350

EUROPE

Austria - Wels
Tel: 43-7242-2244-39
Fax: 43-7242-2244-393

Denmark - Copenhagen
Tel: 45-4450-2828
Fax: 45-4485-2829

France - Paris
Tel: 33-1-69-53-63-20
Fax: 33-1-69-30-90-79

Germany - Munich
Tel: 49-89-627-144-0
Fax: 49-89-627-144-44

Italy - Milan
Tel: 39-0331-742611
Fax: 39-0331-466781

Netherlands - Drunen
Tel: 31-416-690399
Fax: 31-416-690340

Spain - Madrid
Tel: 34-91-708-08-90
Fax: 34-91-708-08-91

UK - Wokingham
Tel: 44-118-921-5869
Fax: 44-118-921-5820

Компания «Океан Электроники» предлагает заключение долгосрочных отношений при поставках импортных электронных компонентов на взаимовыгодных условиях!

Наши преимущества:

- Поставка оригинальных импортных электронных компонентов напрямую с производств Америки, Европы и Азии, а так же с крупнейших складов мира;
- Широкая линейка поставок активных и пассивных импортных электронных компонентов (более 30 млн. наименований);
- Поставка сложных, дефицитных, либо снятых с производства позиций;
- Оперативные сроки поставки под заказ (от 5 рабочих дней);
- Экспресс доставка в любую точку России;
- Помощь Конструкторского Отдела и консультации квалифицированных инженеров;
- Техническая поддержка проекта, помощь в подборе аналогов, поставка прототипов;
- Поставка электронных компонентов под контролем ВП;
- Система менеджмента качества сертифицирована по Международному стандарту ISO 9001;
- При необходимости вся продукция военного и аэрокосмического назначения проходит испытания и сертификацию в лаборатории (по согласованию с заказчиком);
- Поставка специализированных компонентов военного и аэрокосмического уровня качества (Xilinx, Altera, Analog Devices, Intersil, Interpoint, Microsemi, Actel, Aeroflex, Peregrine, VPT, Syfer, Eurofarad, Texas Instruments, MS Kennedy, Miteq, Cobham, E2V, MA-COM, Hittite, Mini-Circuits, General Dynamics и др.);

Компания «Океан Электроники» является официальным дистрибьютором и эксклюзивным представителем в России одного из крупнейших производителей разъемов военного и аэрокосмического назначения «JONHON», а так же официальным дистрибьютором и эксклюзивным представителем в России производителя высокотехнологичных и надежных решений для передачи СВЧ сигналов «FORSTAR».



JONHON

«JONHON» (основан в 1970 г.)

Разъемы специального, военного и аэрокосмического назначения:

(Применяются в военной, авиационной, аэрокосмической, морской, железнодорожной, горно- и нефтедобывающей отраслях промышленности)

«FORSTAR» (основан в 1998 г.)

ВЧ соединители, коаксиальные кабели,
кабельные сборки и микроволновые компоненты:

(Применяются в телекоммуникациях гражданского и специального назначения, в средствах связи, РЛС, а так же военной, авиационной и аэрокосмической отраслях промышленности).



Телефон: 8 (812) 309-75-97 (многоканальный)

Факс: 8 (812) 320-03-32

Электронная почта: ocean@oceanchips.ru

Web: <http://oceanchips.ru/>

Адрес: 198099, г. Санкт-Петербург, ул. Калинина, д. 2, корп. 4, лит. А