

Description: ISM 868/915MHz PCB Antenna with coax feed

Series: Internal Antenna

PART NUMBER: W3312XXXXXX



Features:

- 863-928MHz
- Size 75x15 mm
- Flexible PCB thickness 0.1 mm with adhesive tape
- Mounting with 3M467 adhesive tape on back side
- 100mm 1.13mm OD coax cable with U.F.L connector



Applications:

- Devices with ISM 868MHz / 915MHz radios
- M2M, IoT
- Metering, Industry automation
- Instrumentation

All dimensions are in mm / inches

Issue: 1912

In the effort to improve our products, we reserve the right to make changes judged to be necessary.

CONFIDENTIAL AND PROPRIETARY INFORMATION

This document contains confidential and proprietary information of Pulse Electronics, Inc. (Pulse) and is protected by copyright, trade secret and other state and federal laws. Its receipt or possession does not convey any rights to reproduce, disclose its contents, or to manufacture, use or sell anything it may describe. Reproduction, disclosure or use without specific written authorization of Pulse is strictly forbidden.

For more information:

Pulse Worldwide Headquarters
12220 World Trade Drive
San Diego, CA 92128
USA
Tel: 1-858-674-8100

Pulse/Larsen Antennas
18110 SE 34th St Bldg 2 Suite 250
Vancouver, WA 98683
USA
Tel: 1-360-944-7551

Europe Headquarters
Pulse GmbH & Do, KG
Zeppelinstrasse 15
Herrenberg, Germany
Tel: 49 7032 7806 0

Pulse (Suzhou) Wireless Products Co, Inc.
99 Huo Ju Road(#29 Bldg,4th Phase
Suzhou New District
Jiangsu Province, Suzhou 215009 PR China
Tel: 86 512 6807 9998



Description: ISM 868/915MHz PCB Antenna with coax feed

Series: Internal Antenna

PART NUMBER: W3312XXXXXX

ELECTRINIC SPECIFICATIONS

Frequency	863-928	MHz
Nominal Impedance	50	Ω
Return loss	-8	dB
Efficiency	45	%
Peak Gain	0.8	dBi +/- 1 dB
Polarization:	linear	
Power withstanding	2	W

Note: All RF data measured with 1.5mm polycarbonate plate to simulate loading effect of real device housing.

Description: ISM 868/915MHz PCB Antenna with coax feed

Series: Internal Antenna

PART NUMBER: W3312XXXXXX

This document covers all product variants of the following product family

Antennas	Color	Connector
W3312B0100	Green	1.13mm OD coax cable with U.FL connector
W3312BB0100	BLACK	

Description: ISM 868/915MHz PCB Antenna with coax feed

Series: Internal Antenna

PART NUMBER: W3312XXXXXX

MECHANICAL SPECIFICATIONS

PCB type	Flexible
Radiator size	15[0.59] x 75[2.95] mm[inch]
Adhesive	3M467
Total thickness (Radiator+adhesive)	0.1[0.004] mm[inch]
Weight	0.74g
Cable type	OD 1.13mm coax
Cable length	100[3.94] mm[inch]
Connector	U.FL compatible

ENVIRONMENTAL SPECIFICATIONS

Operating temperature	-40/+85 ° C
-----------------------	-------------

Description: ISM 868/915MHz PCB Antenna with coax feed

Series: Internal Antenna

PART NUMBER: W3312XXXXXX

MECHANICAL DRAWING

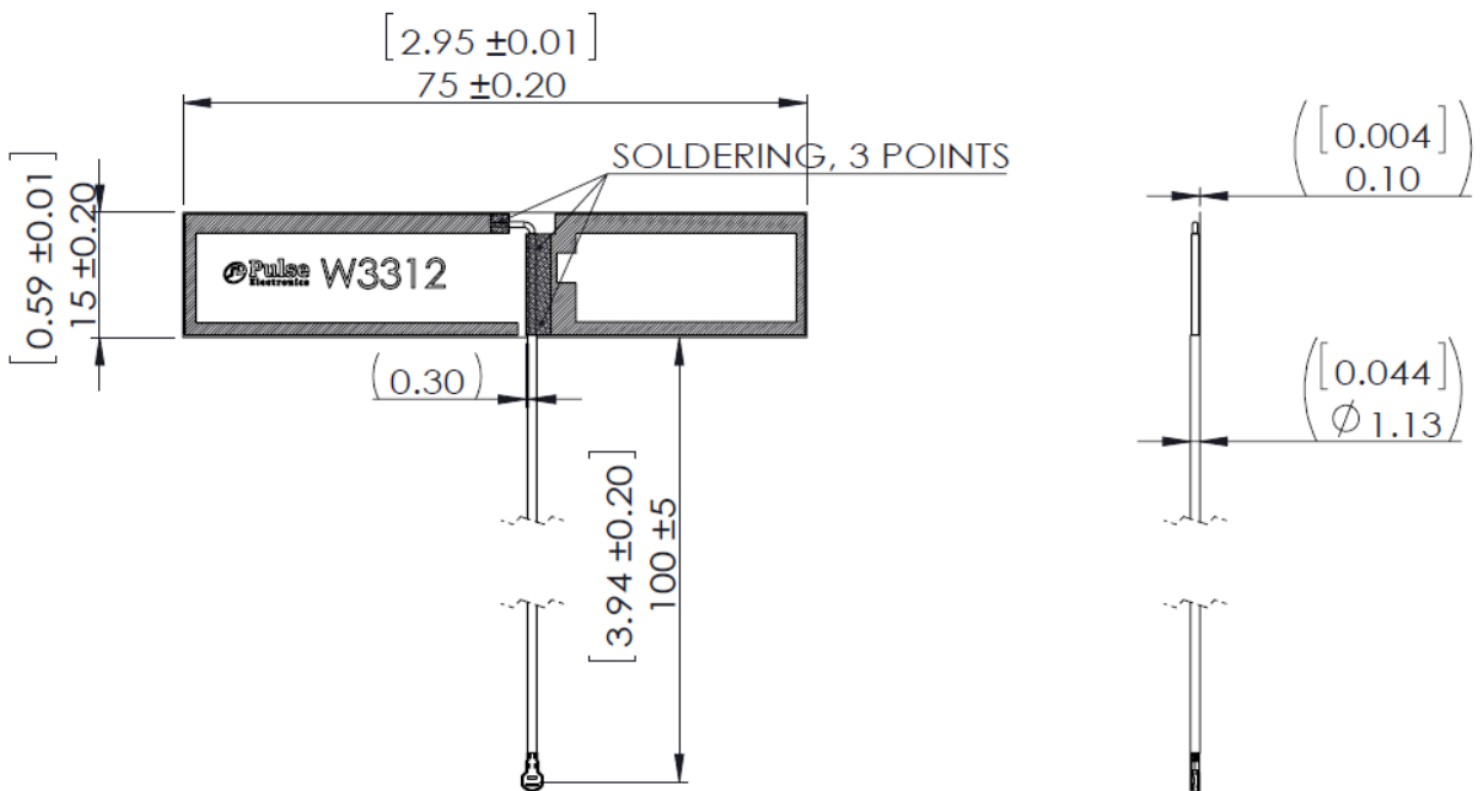

Issue: 1912

In the effort to improve our products, we reserve the right to make changes judged to be necessary.

CONFIDENTIAL AND PROPRIETARY INFORMATION

This document contains confidential and proprietary information of Pulse Electronics, Inc. (Pulse) and is protected by copyright, trade secret and other state and federal laws. Its receipt or possession does not convey any rights to reproduce, disclose its contents, or to manufacture, use or sell anything it may describe. Reproduction, disclosure or use without specific written authorization of Pulse is strictly forbidden.

Description: ISM 868/915MHz PCB Antenna with coax feed

Series: Internal Antenna

PART NUMBER: W3312XXXXXX

CHARTS

Return loss

Return loss vs Frequency measured with 1.5mm polycarbonate plate
W3312B0100 measured in PSU , September 18,2016

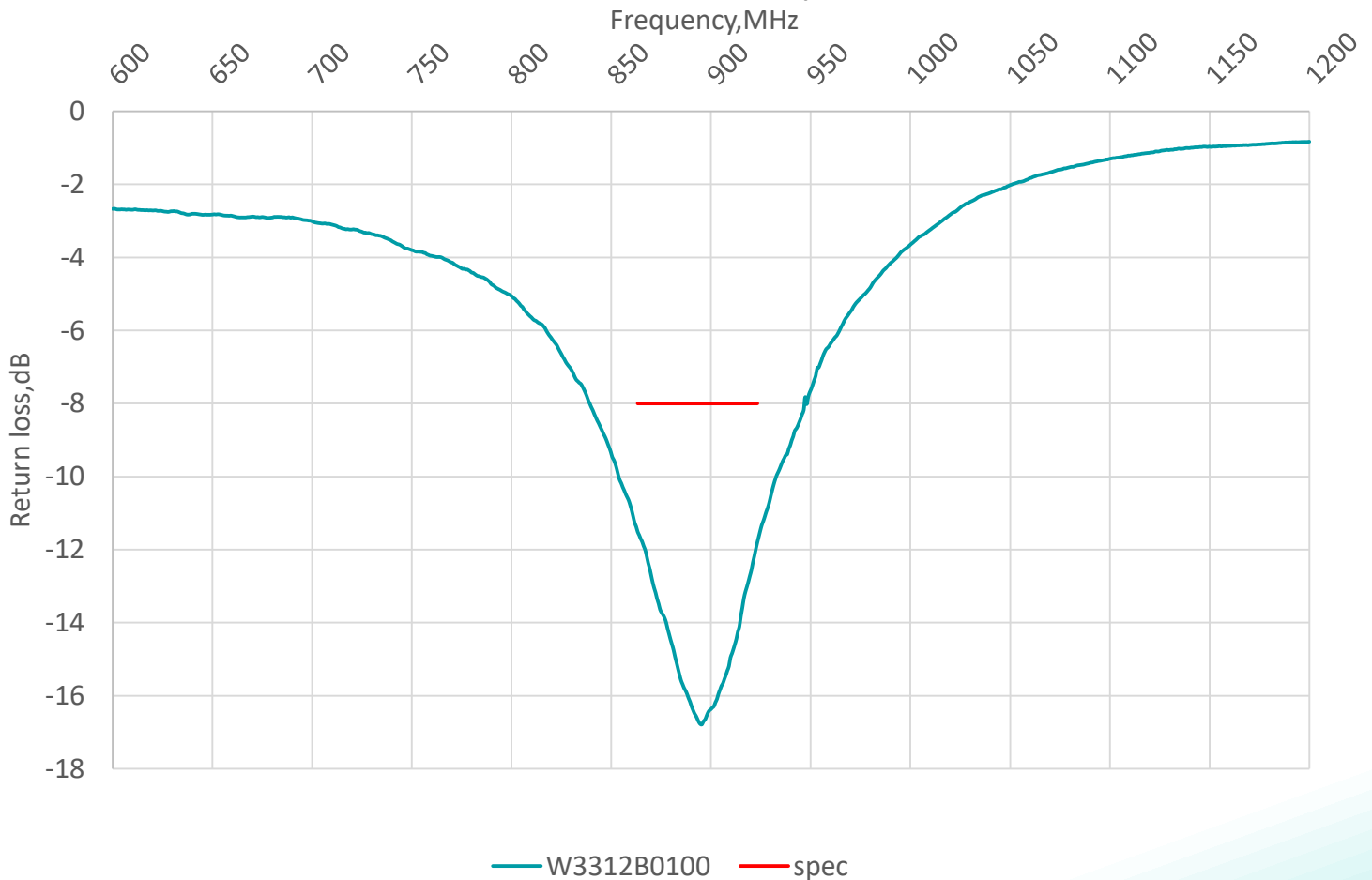

Issue: 1912

In the effort to improve our products, we reserve the right to make changes judged to be necessary.

CONFIDENTIAL AND PROPRIETARY INFORMATION

This document contains confidential and proprietary information of Pulse Electronics, Inc. (Pulse) and is protected by copyright, trade secret and other state and federal laws. Its receipt or possession does not convey any rights to reproduce, disclose its contents, or to manufacture, use or sell anything it may describe. Reproduction, disclosure or use without specific written authorization of Pulse is strictly forbidden.

Description: ISM 868/915MHz PCB Antenna with coax feed

Series: Internal Antenna

PART NUMBER: W3312XXXXXX

CHARTS

Efficiency

Efficiency vs Frequency measured with 1.5mm polycarbonate plate
W3312B0100 measured in PSU ,September 18,2016

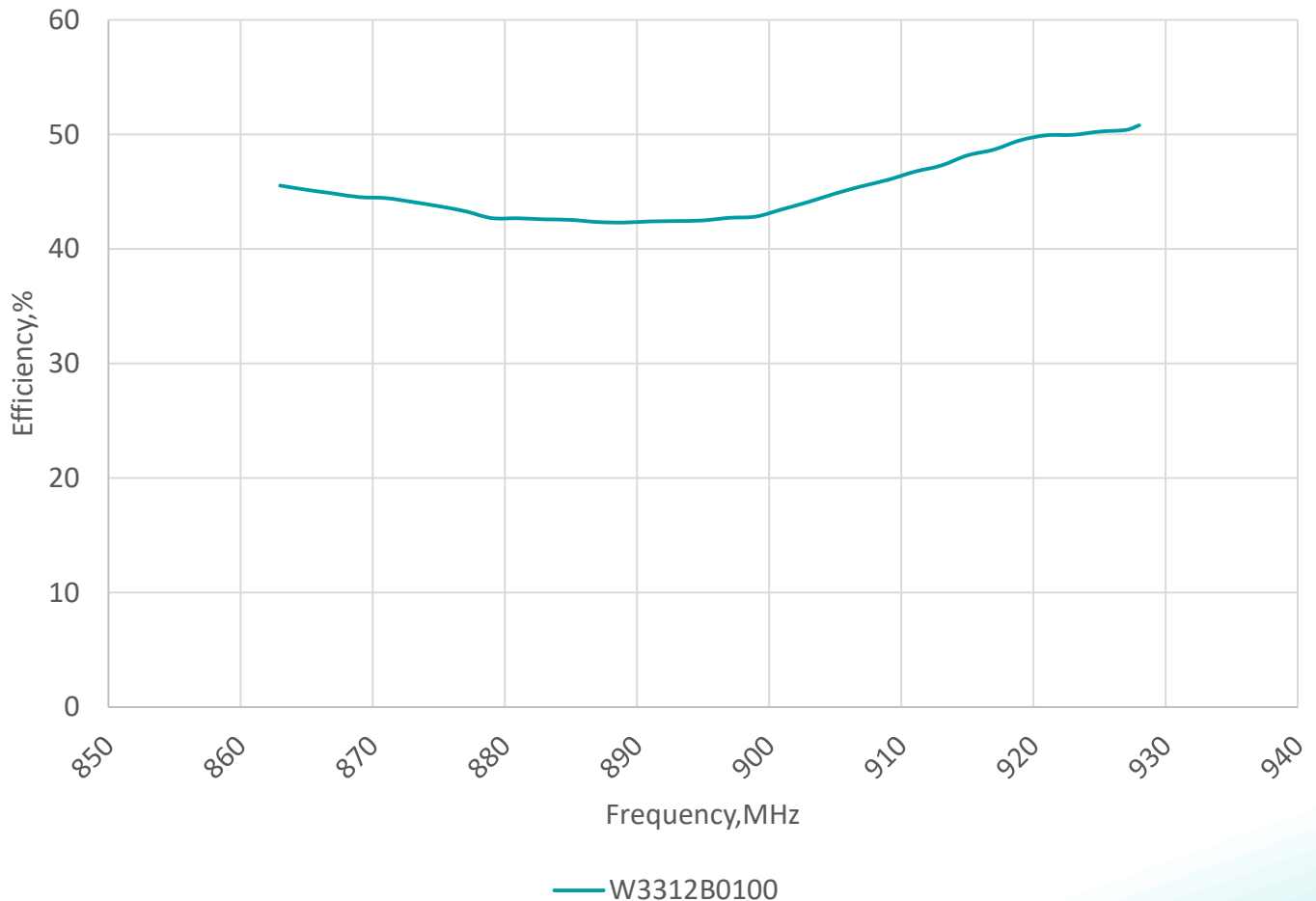

Issue: 1912

In the effort to improve our products, we reserve the right to make changes judged to be necessary.

CONFIDENTIAL AND PROPRIETARY INFORMATION

This document contains confidential and proprietary information of Pulse Electronics, Inc. (Pulse) and is protected by copyright, trade secret and other state and federal laws. Its receipt or possession does not convey any rights to reproduce, disclose its contents, or to manufacture, use or sell anything it may describe. Reproduction, disclosure or use without specific written authorization of Pulse is strictly forbidden.

Description: ISM 868/915MHz PCB Antenna with coax feed

Series: Internal Antenna

PART NUMBER: W3312XXXXXX

CHARTS

Peak Gain

Peak Gain vs Frequency measured with 1.5mm polycarbonate plate
 W3312B0100 measured in PSU, September 18, 2016

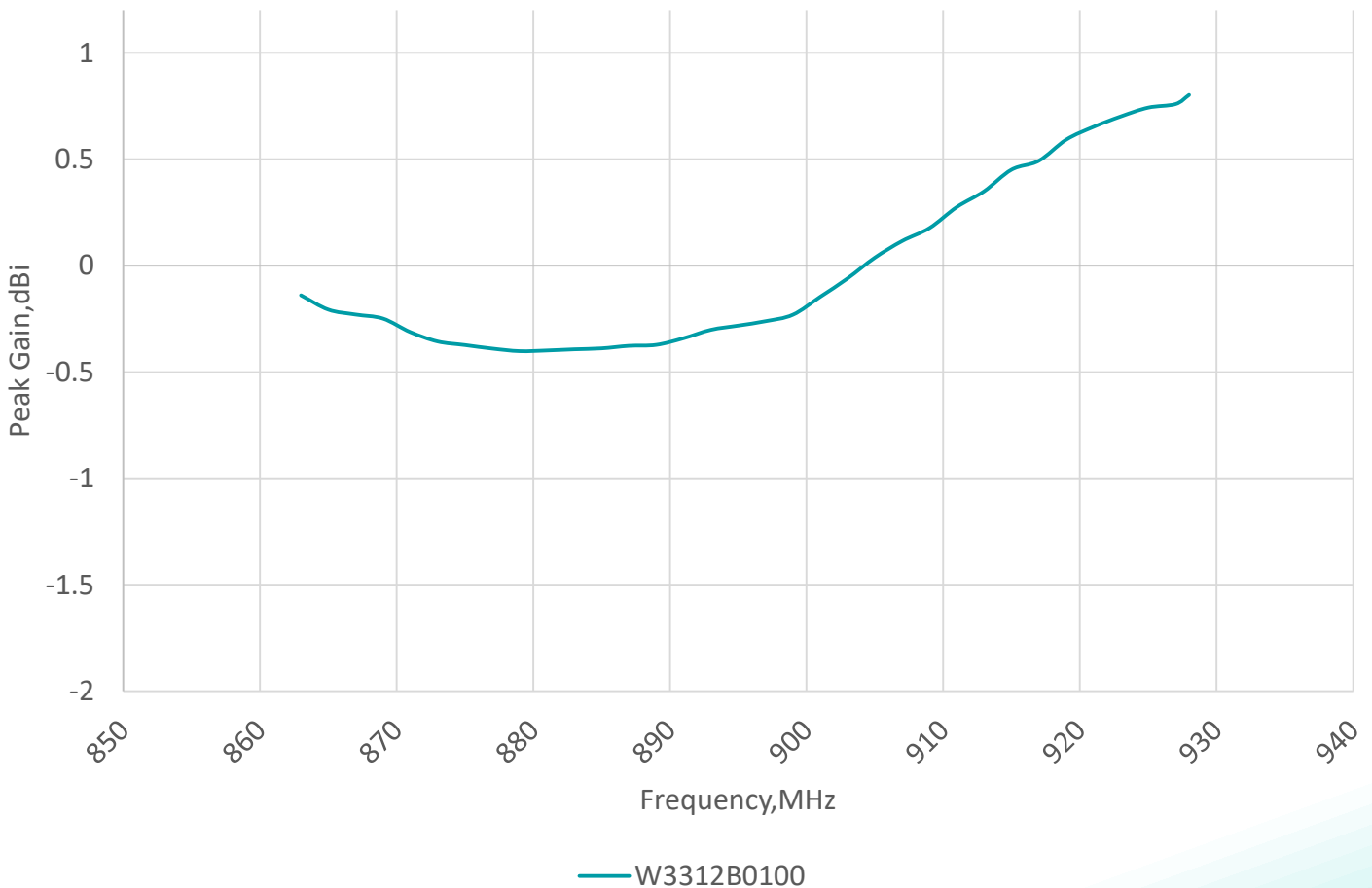

Issue: 1912

In the effort to improve our products, we reserve the right to make changes judged to be necessary.

CONFIDENTIAL AND PROPRIETARY INFORMATION

This document contains confidential and proprietary information of Pulse Electronics, Inc. (Pulse) and is protected by copyright, trade secret and other state and federal laws. Its receipt or possession does not convey any rights to reproduce, disclose its contents, or to manufacture, use or sell anything it may describe. Reproduction, disclosure or use without specific written authorization of Pulse is strictly forbidden.



Description: ISM 868/915MHz PCB Antenna with coax feed

Series: Internal Antenna

PART NUMBER: W3312XXXXXX

CHARTS

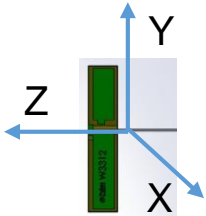

Gain Plots

XY Plane

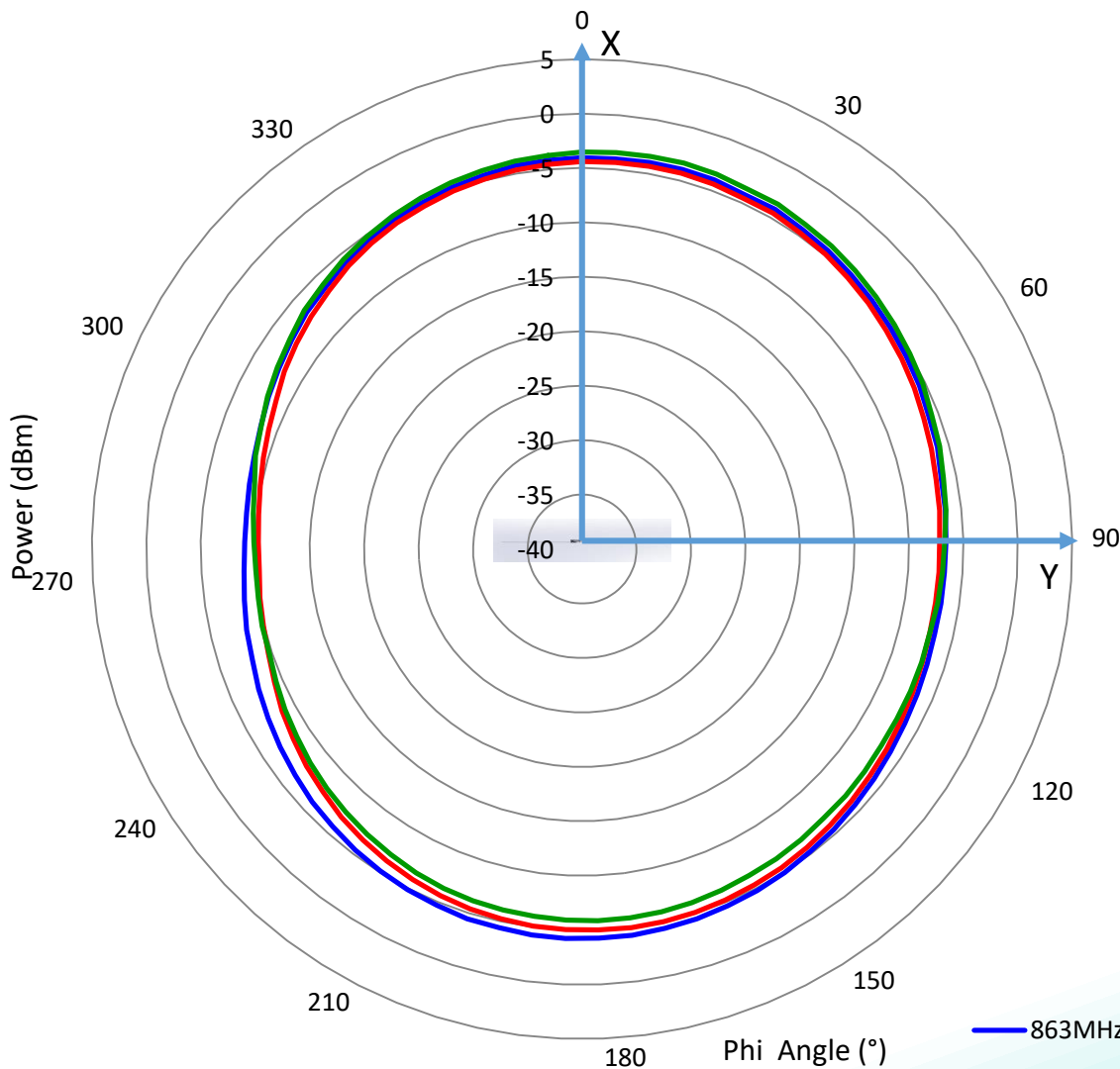

863MHz
Avg (dBi) = -5.79
Peak (dBi) = -3.95
Avg -3 (deg) = 290

895MHz
Avg (dBi) = -6.48
Peak (dBi) = -4.29
Avg -3 (deg) = 250

928MHz
Avg (dBi) = -6.32
Peak (dBi) = -3.34
Avg -3 (deg) = 175

— 863MHz — 895MHz — 928MHz

Issue: 1912

In the effort to improve our products, we reserve the right to make changes judged to be necessary.

CONFIDENTIAL AND PROPRIETARY INFORMATION

This document contains confidential and proprietary information of Pulse Electronics, Inc. (Pulse) and is protected by copyright, trade secret and other state and federal laws. Its receipt or possession does not convey any rights to reproduce, disclose its contents, or to manufacture, use or sell anything it may describe. Reproduction, disclosure or use without specific written authorization of Pulse is strictly forbidden.



Description: ISM 868/915MHz PCB Antenna with coax feed

Series: Internal Antenna

PART NUMBER: W3312XXXXXX

CHARTS

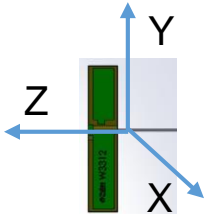

Gain Plots

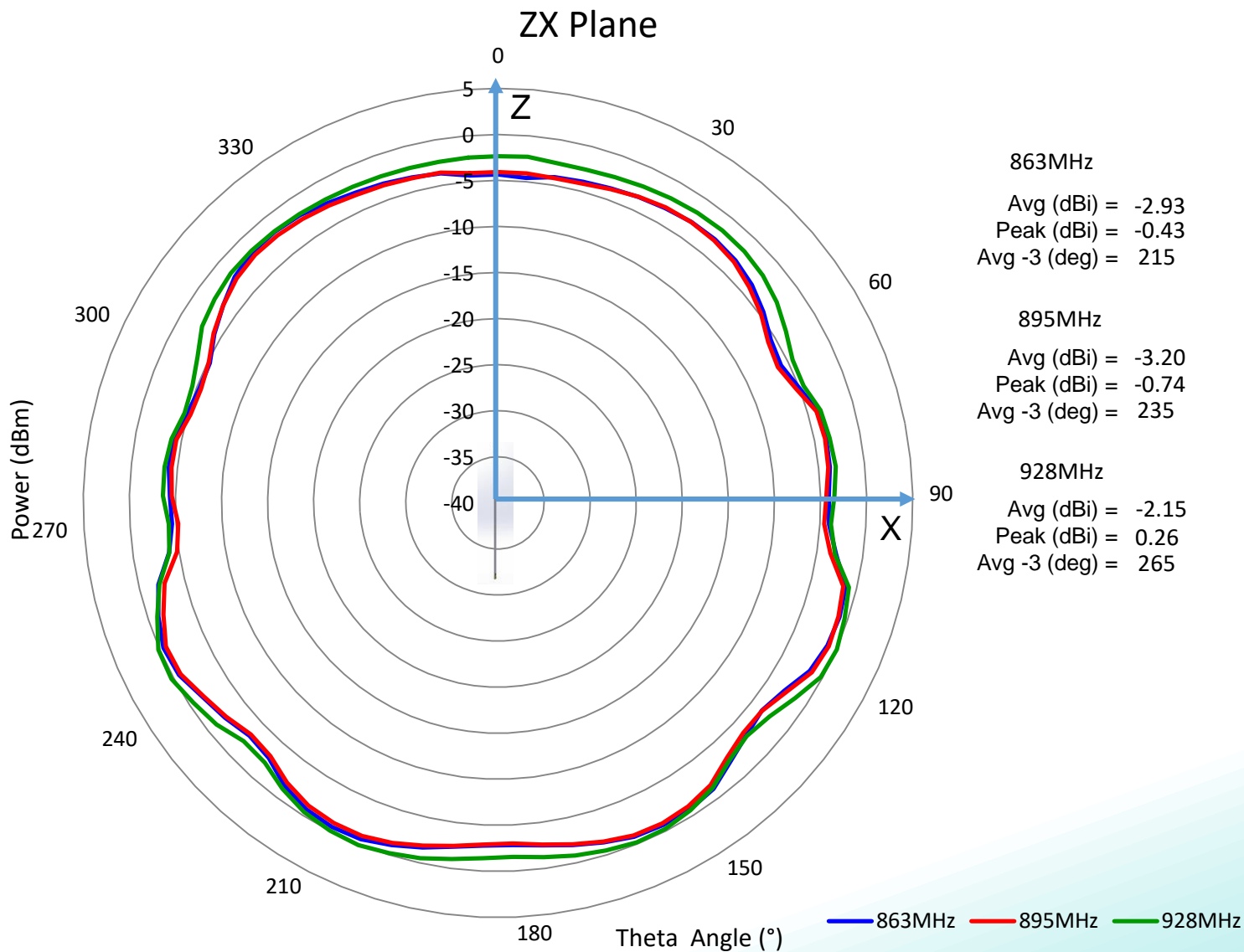

Issue: 1912

In the effort to improve our products, we reserve the right to make changes judged to be necessary.

CONFIDENTIAL AND PROPRIETARY INFORMATION

This document contains confidential and proprietary information of Pulse Electronics, Inc. (Pulse) and is protected by copyright, trade secret and other state and federal laws. Its receipt or possession does not convey any rights to reproduce, disclose its contents, or to manufacture, use or sell anything it may describe. Reproduction, disclosure or use without specific written authorization of Pulse is strictly forbidden.



Description: ISM 868/915MHz PCB Antenna with coax feed

Series: Internal Antenna

PART NUMBER: W3312XXXXXX

CHARTS

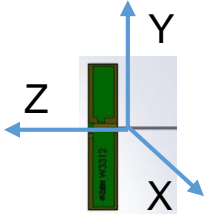

Gain Plots

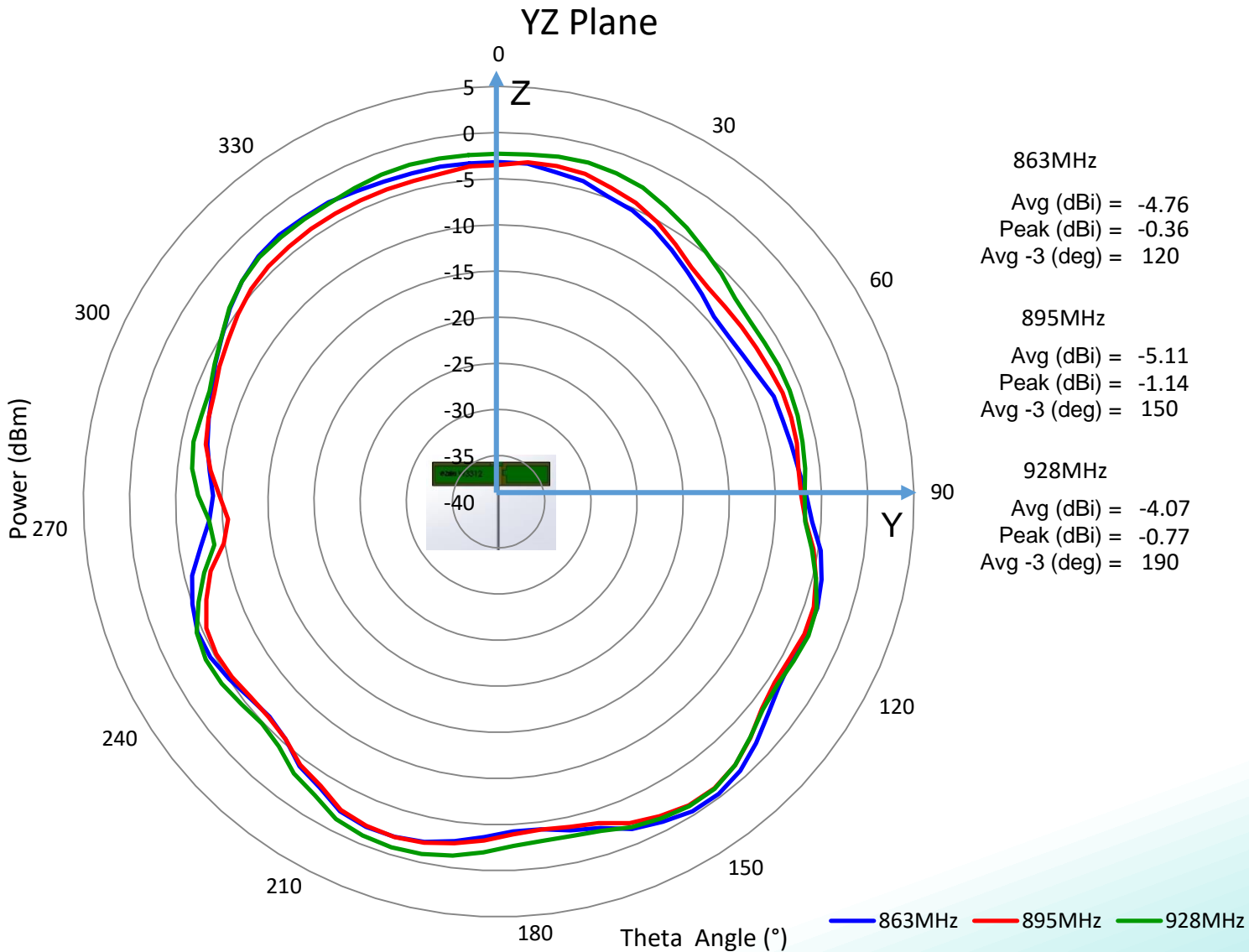

Issue: 1912

In the effort to improve our products, we reserve the right to make changes judged to be necessary.

CONFIDENTIAL AND PROPRIETARY INFORMATION

This document contains confidential and proprietary information of Pulse Electronics, Inc. (Pulse) and is protected by copyright, trade secret and other state and federal laws. Its receipt or possession does not convey any rights to reproduce, disclose its contents, or to manufacture, use or sell anything it may describe. Reproduction, disclosure or use without specific written authorization of Pulse is strictly forbidden.

Description: ISM 868/915MHz PCB Antenna with coax feed

PART NUMBER: W3312XXXXXX

Series: Internal Antenna

PACKAGING

10PCS/PE bag

10 PE bag/foam bag

15 foam bag/carton box

Total 1500PCS/carton box



Issue: 1912

In the effort to improve our products, we reserve the right to make changes judged to be necessary.

CONFIDENTIAL AND PROPRIETARY INFORMATION

This document contains confidential and proprietary information of Pulse Electronics, Inc. (Pulse) and is protected by copyright, trade secret and other state and federal laws. Its receipt or possession does not convey any rights to reproduce, disclose its contents, or to manufacture, use or sell anything it may describe. Reproduction, disclosure or use without specific written authorization of Pulse is strictly forbidden.

Компания «Океан Электроники» предлагает заключение долгосрочных отношений при поставках импортных электронных компонентов на взаимовыгодных условиях!

Наши преимущества:

- Поставка оригинальных импортных электронных компонентов напрямую с производств Америки, Европы и Азии, а так же с крупнейших складов мира;
- Широкая линейка поставок активных и пассивных импортных электронных компонентов (более 30 млн. наименований);
- Поставка сложных, дефицитных, либо снятых с производства позиций;
- Оперативные сроки поставки под заказ (от 5 рабочих дней);
- Экспресс доставка в любую точку России;
- Помощь Конструкторского Отдела и консультации квалифицированных инженеров;
- Техническая поддержка проекта, помощь в подборе аналогов, поставка прототипов;
- Поставка электронных компонентов под контролем ВП;
- Система менеджмента качества сертифицирована по Международному стандарту ISO 9001;
- При необходимости вся продукция военного и аэрокосмического назначения проходит испытания и сертификацию в лаборатории (по согласованию с заказчиком);
- Поставка специализированных компонентов военного и аэрокосмического уровня качества (Xilinx, Altera, Analog Devices, Intersil, Interpoint, Microsemi, Actel, Aeroflex, Peregrine, VPT, Syfer, Eurofarad, Texas Instruments, MS Kennedy, Miteq, Cobham, E2V, MA-COM, Hittite, Mini-Circuits, General Dynamics и др.);

Компания «Океан Электроники» является официальным дистрибьютором и эксклюзивным представителем в России одного из крупнейших производителей разъемов военного и аэрокосмического назначения «JONHON», а так же официальным дистрибьютором и эксклюзивным представителем в России производителя высокотехнологичных и надежных решений для передачи СВЧ сигналов «FORSTAR».



JONHON

«JONHON» (основан в 1970 г.)

Разъемы специального, военного и аэрокосмического назначения:

(Применяются в военной, авиационной, аэрокосмической, морской, железнодорожной, горно- и нефтедобывающей отраслях промышленности)

«FORSTAR» (основан в 1998 г.)

ВЧ соединители, коаксиальные кабели, кабельные сборки и микроволновые компоненты:

(Применяются в телекоммуникациях гражданского и специального назначения, в средствах связи, РЛС, а так же военной, авиационной и аэрокосмической отраслях промышленности).



Телефон: 8 (812) 309-75-97 (многоканальный)

Факс: 8 (812) 320-03-32

Электронная почта: ocean@oceanchips.ru

Web: <http://oceanchips.ru/>

Адрес: 198099, г. Санкт-Петербург, ул. Калинина, д. 2, корп. 4, лит. А