

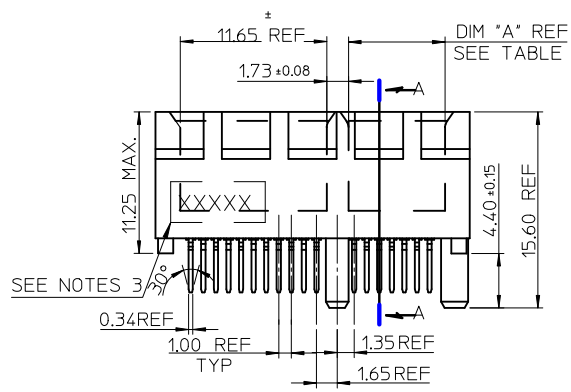

- NOTES:
- 1.MATERIALS:
1-1.HOUSING: SEE TABLE ,GLASS FIBER FILLED UL94V-0, COLOR: SEE TABLE.
1-2.CONTACT: SEE TABLE
 - 2.PLATING:
2-1.CONTACT AREA: GOLD, THICKNESS : SEE TABLE .
2-2.SOLDER TAIL: 100 MICRINCH MIN. TIN PLATING.
2-3.UNDER PLATING: NICKEL PLATING OVERALL.
 - 3.WEEK CODE: XX(YEAR) XXI(WEEK) X(LOCATION),
 - 4.PRODUCT SPECIFICATION REFER TO PS-87715-200.
 - 5.PACKAGING SPECIFICATION REFER TO PK-87715-207.
 - 6.TEST SUMMARY:REFER TO TS-87715-207.
 - 7.LEAD FREE AND ROHS COMPLIANCE PRODUCT.



CONNECTOR LINK WIDTH	# POS REF	N	DIM 'A'	DIM 'B'	DIM 'C'
X1	36	6	7.65	25.00	9.15
X4	64	20	21.65	39.00	23.15
X8	98	37	38.65	56.00	40.15
X16	164	70	71.65	89.00	73.15

PCB THK (REF)	DIM 'D'
1.60	2.30
1.58	2.54
2.36	3.00

REVISED IEC NO: SH2010-0468 DRWNR:ZHANG CHKD:ALLEN L LIN APPR:X.J.SONG	2010/06/15 2004/07/20 2010/07/02	QUALITY SYMBOLS F=0 E=0 A=0	GENERAL TOLERANCES (UNLESS SPECIFIED)		DIMENSION STYLE MM ONLY		SCALE	DESIGN UNITS	THIRD ANGLE PROJECTION		
				mm	INCH	DRAWN BY		DATE	TITLE		
			4 PLACES	± ---	± ---	TOM		2004/07/20	PCI EXPRESS		
			3 PLACES	± ---	± ---	CHECKED BY		DATE	EDGE CARD CONNECTOR		
	2 PLACES	± 0.25	± ---	ALLEN LIN		2004/07/20	(LEAD FREE VERSION)				
	1 PLACE	± 0.25	± ---	APPROVED BY		DATE	MOLEX INCORPORATED				
	ANGULAR ± 3 °		MATERIAL NO.		2004/07/20		DOCUMENT NO.				
DRAFT WHERE APPLICABLE MUST REMAIN WITHIN DIMENSIONS			SEE SHEET 4		SD-87715-207		SHEET NO.				
			SIZE A3		THIS DRAWING CONTAINS INFORMATION THAT IS PROPRIETARY TO MOLEX INCORPORATED AND SHOULD NOT BE USED WITHOUT WRITTEN PERMISSION						



← I/O PANEL DIRECTION

PRIMARY (COMPONENT) SIDE

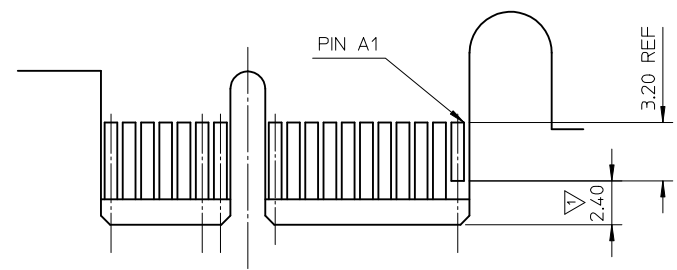

I/O PANEL DIRECTION →

SECONDARY (SOLDER) SIDE

- 1 NO TIE BAR PERMITTED FROM CARD EDGE TO LEADING EDGE OF PAD FOR PINS A1 AND "C".
- 2 CHAMFER EDGES MUST BE FREE OF CUTTING BURRS.
- 3. TOLERANCE: .XX±.13

CONNECTOR LINK WIDTH	# POS REF	N	DIM 'B'	'C' Δ
X1	36	6	8.15	B17
X4	64	20	22.15	B17, B31
X8	98	37	39.15	B17, B31 B48
X16	164	70	72.15	B17, B31 B48, B81

SEE SHEET 1 EC NO: SH2010-0468 DRWR: ZHANG 2010/06/15 CHKD: ALLEN LIN 2004/07/20 APPR: XJ.SONG 2010/07/02	QUALITY SYMBOLS	GENERAL TOLERANCES (UNLESS SPECIFIED)		DIMENSION STYLE	SCALE	DESIGN UNITS	THIRD ANGLE PROJECTION
	$\nabla_{\text{A}}=0$	mm	INCH	MM ONLY		METRIC	
	$\nabla_{\text{B}}=0$	4 PLACES ± --- ± ---		DRAWN BY	DATE	TITLE	
	$\nabla_{\text{C}}=0$	3 PLACES ± --- ± ---		TOM	2004/07/20	PCI EXPRESS EDGE CARD CONNECTOR (LEAD FREE VERSION)	
	2 PLACES ± 0.25 ± ---		CHECKED BY	DATE	MOLEX INCORPORATED		
	1 PLACE ± 0.25 ± ---		ALLEN LIN	2004/07/20	MATERIAL NO. DOCUMENT NO.		
	ANGULAR ± 3°		APPROVED BY	DATE	SEE SHEET 4 SD-87715-207		
			WILSON	2004/07/20	SHEET NO.		
			DRAFT WHERE APPLICABLE MUST REMAIN WITHIN DIMENSIONS		3 OF 4		
			SIZE A3		THIS DRAWING CONTAINS INFORMATION THAT IS PROPRIETARY TO MOLEX INCORPORATED AND SHOULD NOT BE USED WITHOUT WRITTEN PERMISSION		

MOLEX P/N	CIRCUIT SIZE	HOUSING MATERIAL	HOUSING COLOR	TERMINAL MATERIAL	CONTACT PLATING	SOLDER TAIL 'D' LENGTH	
87715-9001	36	NYLON46	BLACK	PHOSPHOR BRONZE	10 MICROINCH	2.54	
87715-9003					GOLD FLASH		
87715-9004					10 MICROINCH	3.00	
87715-9007					GOLD FLASH		
87715-9008					15 MICROINCH		2.30

MOLEX P/N	CIRCUIT SIZE	HOUSING MATERIAL	HOUSING COLOR	TERMINAL MATERIAL	CONTACT PLATING	SOLDER TAIL 'D' LENGTH
87715-9100	64	NYLON46	BLACK	PHOSPHOR BRONZE	GOLD FLASH	2.54
87715-9101					10 MICROINCH	
87715-9102					15 MICROINCH	3.00
87715-9103					GOLD FLASH	
87715-9104					10 MICROINCH	
87715-9105					15 MICROINCH	
87715-9106					30 MICROINCH	2.54
87715-9107					GOLD FLASH	2.30
87715-9108					15 MICROINCH	
87715-9109					30 MICROINCH	

MOLEX P/N	CIRCUIT SIZE	HOUSING MATERIAL	HOUSING COLOR	TERMINAL MATERIAL	CONTACT PLATING	SOLDER TAIL 'D' LENGTH
87715-9200	98	NYLON46	BLACK	PHOSPHOR BRONZE	GOLD FLASH	2.54
87715-9201					10 MICROINCH	
87715-9202					15 MICROINCH	3.00
87715-9203					GOLD FLASH	
87715-9204					10 MICROINCH	
87715-9205					15 MICROINCH	
87715-9206					30 MICROINCH	2.54
87715-9207					GOLD FLASH	2.30
87715-9208					15 MICROINCH	
87715-9209					30 MICROINCH	

MOLEX P/N	CIRCUIT SIZE	HOUSING MATERIAL	HOUSING COLOR	TERMINAL MATERIAL	CONTACT PLATING	SOLDER TAIL 'D' LENGTH
87715-9602	98	NYLON46	BLACK	BRASS	15 MICROINCH	2.54

MOLEX P/N	CIRCUIT SIZE	HOUSING MATERIAL	HOUSING COLOR	TERMINAL MATERIAL	CONTACT PLATING	SOLDER TAIL 'D' LENGTH
87715-9301	164	NYLON46	BLACK	PHOSPHOR BRONZE	10 MICROINCH	2.54
87715-9304						3.00
87715-9307					GOLD FLASH	2.30
87715-9308					15 MICROINCH	

SEE SHEET 1 EC NO: SH2010-0468 DRW:RZHANG 2010/06/15 CHKD:ALLEN LIN 2004/07/20 APPR:XJ.SONG 2010/07/02	QUALITY SYMBOLS	GENERAL TOLERANCES (UNLESS SPECIFIED)		DIMENSION STYLE MM ONLY		SCALE	DESIGN UNITS METRIC	THIRD ANGLE PROJECTION
	$F_A=0$	4 PLACES	mm	INCH	DRAWN BY	DATE	TITLE	
	$F_C=0$	3 PLACES	± ---	± ---	CHECKED BY	DATE	PCI EXPRESS EDGE CARD CONNECTOR (LEAD FREE VERSION)	
	$F_B=0$	2 PLACES	± 0.25	± ---	APPROVED BY	DATE	MOLEX INCORPORATED	
		1 PLACE	± 0.25	± ---	WILSON	2004/07/20	DOCUMENT NO.	SHEET NO.
		ANGULAR ± 3 °		MATERIAL NO.		SD-87715-207		4 OF 4
		DRAFT WHERE APPLICABLE MUST REMAIN WITHIN DIMENSIONS		SEE TABLE		THIS DRAWING CONTAINS INFORMATION THAT IS PROPRIETARY TO MOLEX INCORPORATED AND SHOULD NOT BE USED WITHOUT WRITTEN PERMISSION		

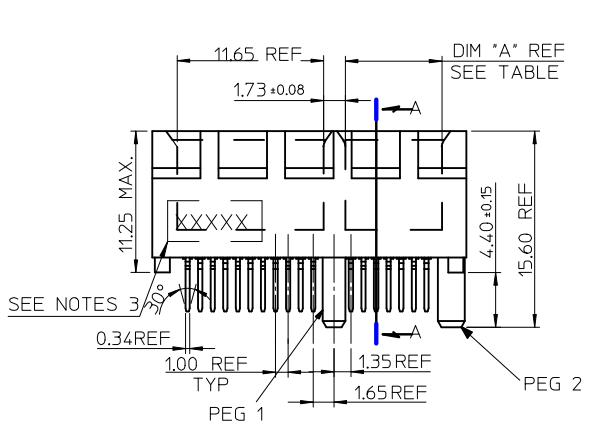
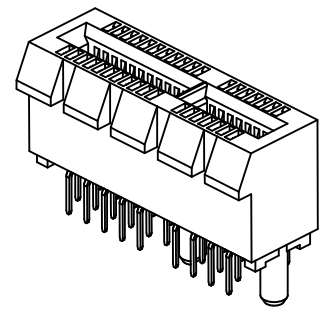

- NOTES:
- MATERIALS:
 - HOUSING: SEE TABLE ,GLASS FIBER FILLED UL94V-0, COLOR: SEE TABLE.
 - CONTACT: SEE TABLE
 - PLATING:
 - CONTACT AREA: GOLD, THICKNESS : SEE TABLE .
 - SOLDER TAIL: 100 MICRONCH MIN. TIN PLATING.
 - UNDER PLATING: NICKEL PLATING OVERALL.
 - DATE CODE: YY MM DD.
 - PRODUCT SPECIFICATION REFER TO PS-87715-200.
 - TEST SUMMARY:REFER TO TS-87715-207.

CONNECTOR LINK WIDTH	# POS REF	N	DIM 'A'	DIM 'B'	DIM 'C'
X1	36	6	7.65	25.00	9.15
X16	164	70	71.65	89.00	73.15

PCB THK (REF)	DIM 'D'
1.58	2.54
2.36	3.00

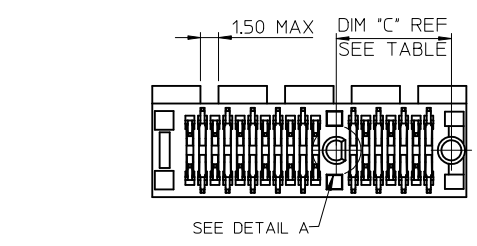

REVISED EC NO: SH2011-0358 DRWN:FYANG05 2011/06/02 CHKD: APPR:RZHANG 2011/06/07 REV	QUALITY SYMBOLS	GENERAL TOLERANCES (UNLESS SPECIFIED)	DIMENSION STYLE	SCALE	DESIGN UNITS	THIRD ANGLE PROJECTION
	$\nabla = 0$ $\nabla = 0$ $\nabla = 0$	mm INCH 4 PLACES ± --- ± --- 3 PLACES ± --- ± --- 2 PLACES ± 0.25 ± --- 1 PLACE ± 0.25 ± --- ANGULAR ± 3°	MM ONLY	SCALE	METRIC	
		DRAFT WHERE APPLICABLE MUST REMAIN WITHIN DIMENSIONS	DRAWN BY: DAVID HU DATE: 2007/05/14 CHECKED BY: HARVEY DATE: 2007/05/14 APPROVED BY: JENNY CHEN DATE: 2007/05/14 MATERIAL NO.	TITLE		PCI EXPRESS EDGE CARD CONNECTOR (LEAD FREE VERSION)
			SEE SHEET 4 THIS DRAWING CONTAINS INFORMATION THAT IS PROPRIETARY TO MOLEX INCORPORATED AND SHOULD NOT BE USED WITHOUT WRITTEN PERMISSION	MOLEX MOLEX INCORPORATED	DOCUMENT NO. SD-87715-901	SHEET NO. 1 OF 4

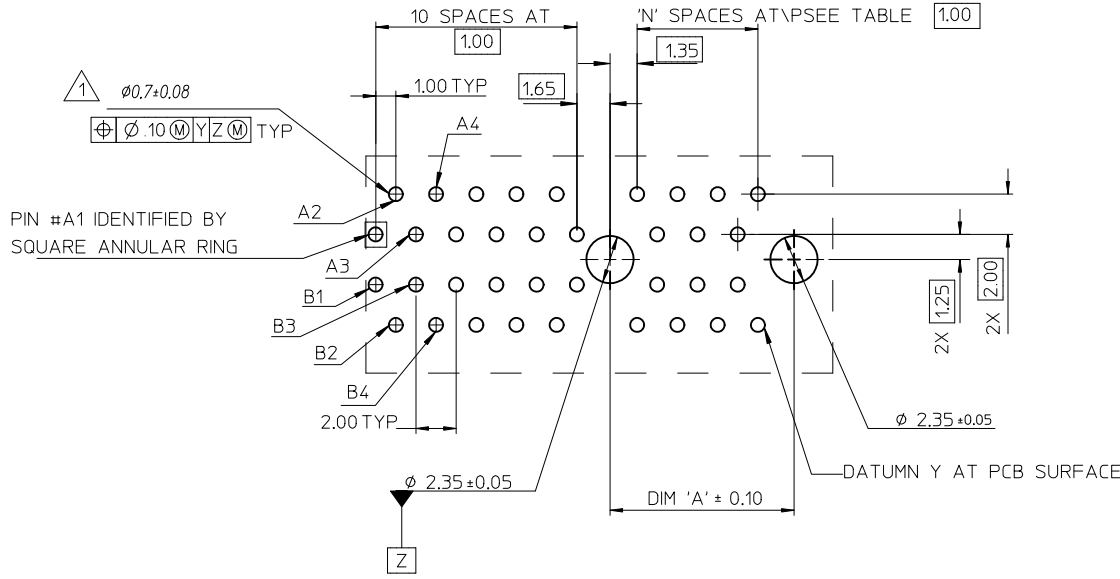

1 THE HORIZONTAL AXIS FOR THE HOLE PATTERN IS ESTABLISHED BY A LINE THROUGH THE CENTER OF THE TWO $\phi 2.35$ HOLES. THE VERTICAL AXIS IS 90° TO THE HORIZONTAL AXIS, THROUGH THE CENTER OF DATUM Z

PIN #A1 IDENTIFIED BY SQUARE ANNULAR RING

CONNECTOR LINK WIDTH	# POS REF	N	DIM 'A'
X1	36	6	9.15
X16	164	70	73.15

SEE SHEET 1 EC NO: SH2011-0358 DRWN: YANG05 CHKD: APPR: RZHANG REV	QUALITY SYMBOLS	GENERAL TOLERANCES (UNLESS SPECIFIED)	DIMENSION STYLE	SCALE	DESIGN UNITS	THIRD ANGLE PROJECTION	
	$F_A=0$ $F_C=0$ $F_P=0$	mm INCH 4 PLACES ± --- ± --- 3 PLACES ± --- ± --- 2 PLACES ± 0.25 ± --- 1 PLACE ± 0.25 ± --- ANGULAR ± 3°	MM ONLY	DRAWN BY DATE DAVID HU 2007/05/14 CHECKED BY DATE HARVEY 2007/05/14 APPROVED BY DATE JENNY CHEN 2007/05/14 MATERIAL NO.	TITLE	PCI EXPRESS EDGE CARD CONNECTOR (LEAD FREE VERSION)	MOLEX INCORPORATED DOCUMENT NO. SD-87715-901 SHEET NO. 2 OF 4
	DRAFT WHERE APPLICABLE MUST REMAIN WITHIN DIMENSIONS		SEE SHEET 1	THIS DRAWING CONTAINS INFORMATION THAT IS PROPRIETARY TO MOLEX INCORPORATED AND SHOULD NOT BE USED WITHOUT WRITTEN PERMISSION			
			SIZE A3				



← I/O PANEL DIRECTION

PRIMARY (COMPONENT) SIDE

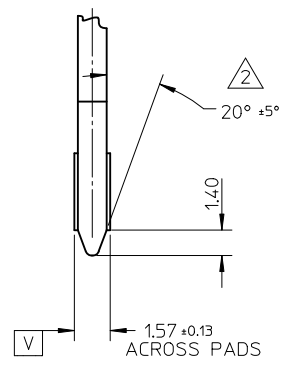

- 1 NO TIE BAR PERMITTED FROM CARD EDGE TO LEADING EDGE OF PAD FOR PINS A1 AND "C".
- 2 CHAMFER EDGES MUST BE FREE OF CUTTING BURRS.
- 3 TOLERANCE: .XX±.13

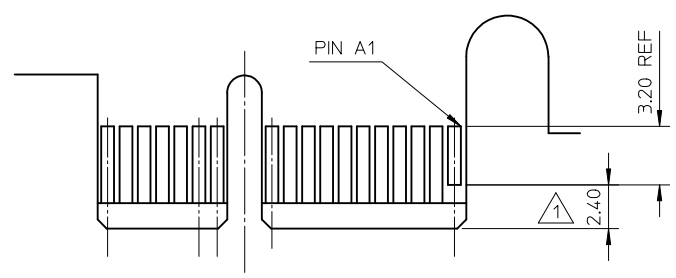

I/O PANEL DIRECTION →

SECONDARY (SOLDER) SIDE

CONNECTOR LINK WIDTH	# POS REF	N	DIM 'B'	'C' 1
X1	36	6	8.15	B17
X16	164	70	72.15	B17, B31 B48, B81

SEE SHEET 1 EC NO: SH2011-0358 DRWN: YANG05 CHKD: APPR: RZHANG	2011/06/02 2011/06/07	QUALITY SYMBOLS	GENERAL TOLERANCES (UNLESS SPECIFIED)		DIMENSION STYLE MM ONLY		SCALE	DESIGN UNITS METRIC	THIRD ANGLE PROJECTION																																												
		$F_A = 0$ $F_C = 0$ $F_B = 0$	<table border="1"> <tr> <th></th> <th>mm</th> <th>INCH</th> </tr> <tr> <td>4 PLACES</td> <td>± ---</td> <td>± ---</td> </tr> <tr> <td>3 PLACES</td> <td>± ---</td> <td>± ---</td> </tr> <tr> <td>2 PLACES</td> <td>± 0.25</td> <td>± ---</td> </tr> <tr> <td>1 PLACE</td> <td>± 0.25</td> <td>± ---</td> </tr> </table>		mm	INCH	4 PLACES	± ---	± ---	3 PLACES	± ---	± ---	2 PLACES	± 0.25	± ---	1 PLACE	± 0.25	± ---	<table border="1"> <tr> <td>DRAWN BY</td> <td>DATE</td> <td>TITLE</td> </tr> <tr> <td>DAVID HU</td> <td>2007/05/14</td> <td rowspan="3">PCI EXPRESS EDGE CARD CONNECTOR (LEAD FREE VERSION)</td> </tr> <tr> <td>CHECKED BY</td> <td>DATE</td> </tr> <tr> <td>HARVEY</td> <td>2007/05/14</td> </tr> <tr> <td>APPROVED BY</td> <td>DATE</td> <td rowspan="2">molex MOLEX INCORPORATED</td> </tr> <tr> <td>JENNY CHEN</td> <td>2007/05/14</td> </tr> <tr> <td>MATERIAL NO.</td> <td colspan="2">SEE SHEET 1</td> <td>DOCUMENT NO.</td> <td colspan="2">SD-87715-901</td> <td>SHEET NO.</td> <td colspan="2">3 OF 4</td> </tr> <tr> <td colspan="3">DRAFT WHERE APPLICABLE MUST REMAIN WITHIN DIMENSIONS</td> <td colspan="7">THIS DRAWING CONTAINS INFORMATION THAT IS PROPRIETARY TO MOLEX INCORPORATED AND SHOULD NOT BE USED WITHOUT WRITTEN PERMISSION</td> </tr> </table>	DRAWN BY	DATE	TITLE	DAVID HU	2007/05/14	PCI EXPRESS EDGE CARD CONNECTOR (LEAD FREE VERSION)	CHECKED BY	DATE	HARVEY	2007/05/14	APPROVED BY	DATE	molex MOLEX INCORPORATED	JENNY CHEN	2007/05/14	MATERIAL NO.	SEE SHEET 1		DOCUMENT NO.	SD-87715-901		SHEET NO.	3 OF 4		DRAFT WHERE APPLICABLE MUST REMAIN WITHIN DIMENSIONS			THIS DRAWING CONTAINS INFORMATION THAT IS PROPRIETARY TO MOLEX INCORPORATED AND SHOULD NOT BE USED WITHOUT WRITTEN PERMISSION						
			mm	INCH																																																	
		4 PLACES	± ---	± ---																																																	
3 PLACES	± ---	± ---																																																			
2 PLACES	± 0.25	± ---																																																			
1 PLACE	± 0.25	± ---																																																			
DRAWN BY	DATE	TITLE																																																			
DAVID HU	2007/05/14	PCI EXPRESS EDGE CARD CONNECTOR (LEAD FREE VERSION)																																																			
CHECKED BY	DATE																																																				
HARVEY	2007/05/14																																																				
APPROVED BY	DATE	molex MOLEX INCORPORATED																																																			
JENNY CHEN	2007/05/14																																																				
MATERIAL NO.	SEE SHEET 1		DOCUMENT NO.	SD-87715-901		SHEET NO.	3 OF 4																																														
DRAFT WHERE APPLICABLE MUST REMAIN WITHIN DIMENSIONS			THIS DRAWING CONTAINS INFORMATION THAT IS PROPRIETARY TO MOLEX INCORPORATED AND SHOULD NOT BE USED WITHOUT WRITTEN PERMISSION																																																		



MOLEX P/N	CIRCUIT SIZE	HOUSING MATERIAL	HOUSING COLOR	TERMINAL MATERIAL	CONTACT PLATING	SOLDER TAIL 'D' LENGTH	PEG 1	PEG 2	DESCRIPTION
87715-9000	36	NYLON46	BLACK	PHOSPHOR BRONZE	GOLD FLASH	2.54	WITH	WITH	TOOLED
87715-9002					15 MICROINCH				
87715-9005					15 MICROINCH	3.00			
87715-9006					30 MICROINCH				
87715-9009					30 MICROINCH				



MOLEX P/N	CIRCUIT SIZE	HOUSING MATERIAL	HOUSING COLOR	TERMINAL MATERIAL	CONTACT PLATING	SOLDER TAIL 'D' LENGTH	PEG 1	PEG 2	DESCRIPTION
87715-9300	164	NYLON46	BLACK	PHOSPHOR BRONZE	GOLD FLASH	2.54	WITH	WITH	TOOLED
87715-9302					15 MICROINCH				
87715-9303					GOLD FLASH	3.00			
87715-9305					15 MICROINCH				
87715-9306					30 MICROINCH				
87715-9309					30 MICROINCH	3.00			

SEE SHEET 1 EC NO: SH2011-0358 DRAWN: FANG05 CHK'D: APPR: RZHANG 2011/06/02 2011/06/07	QUALITY SYMBOLS	GENERAL TOLERANCES (UNLESS SPECIFIED)	DIMENSION STYLE	SCALE	DESIGN UNITS	THIRD ANGLE PROJECTION
	$F_A=0$ $F_C=0$ $F_P=0$	mm INCH 4 PLACES ± --- ± --- 3 PLACES ± --- ± --- 2 PLACES ± 0.25 ± --- 1 PLACE ± 0.25 ± --- ANGULAR ± 3 °	MM ONLY	DRAWN BY DATE DAVID HU 2007/05/14 CHECKED BY DATE HARVEY 2007/05/14 APPROVED BY DATE JENNY CHEN 2007/05/14	TITLE	PCI EXPRESS EDGE CARD CONNECTOR (LEAD FREE VERSION)
		DRAFT WHERE APPLICABLE MUST REMAIN WITHIN DIMENSIONS	MATERIAL NO. SEE SHEET 1	DOCUMENT NO. SD-87715-901	SHEET NO. 4 OF 4	
				SIZE A3	THIS DRAWING CONTAINS INFORMATION THAT IS PROPRIETARY TO MOLEX INCORPORATED AND SHOULD NOT BE USED WITHOUT WRITTEN PERMISSION	

Компания «Океан Электроники» предлагает заключение долгосрочных отношений при поставках импортных электронных компонентов на взаимовыгодных условиях!

Наши преимущества:

- Поставка оригинальных импортных электронных компонентов напрямую с производств Америки, Европы и Азии, а так же с крупнейших складов мира;
- Широкая линейка поставок активных и пассивных импортных электронных компонентов (более 30 млн. наименований);
- Поставка сложных, дефицитных, либо снятых с производства позиций;
- Оперативные сроки поставки под заказ (от 5 рабочих дней);
- Экспресс доставка в любую точку России;
- Помощь Конструкторского Отдела и консультации квалифицированных инженеров;
- Техническая поддержка проекта, помощь в подборе аналогов, поставка прототипов;
- Поставка электронных компонентов под контролем ВП;
- Система менеджмента качества сертифицирована по Международному стандарту ISO 9001;
- При необходимости вся продукция военного и аэрокосмического назначения проходит испытания и сертификацию в лаборатории (по согласованию с заказчиком);
- Поставка специализированных компонентов военного и аэрокосмического уровня качества (Xilinx, Altera, Analog Devices, Intersil, Interpoint, Microsemi, Actel, Aeroflex, Peregrine, VPT, Syfer, Eurofarad, Texas Instruments, MS Kennedy, Miteq, Cobham, E2V, MA-COM, Hittite, Mini-Circuits, General Dynamics и др.);

Компания «Океан Электроники» является официальным дистрибьютором и эксклюзивным представителем в России одного из крупнейших производителей разъемов военного и аэрокосмического назначения «**JONHON**», а так же официальным дистрибьютором и эксклюзивным представителем в России производителя высокотехнологичных и надежных решений для передачи СВЧ сигналов «**FORSTAR**».



JONHON

«**JONHON**» (основан в 1970 г.)

Разъемы специального, военного и аэрокосмического назначения:

(Применяются в военной, авиационной, аэрокосмической, морской, железнодорожной, горно- и нефтедобывающей отраслях промышленности)

«**FORSTAR**» (основан в 1998 г.)

ВЧ соединители, коаксиальные кабели, кабельные сборки и микроволновые компоненты:

(Применяются в телекоммуникациях гражданского и специального назначения, в средствах связи, РЛС, а так же военной, авиационной и аэрокосмической отраслях промышленности).



Телефон: 8 (812) 309-75-97 (многоканальный)

Факс: 8 (812) 320-03-32

Электронная почта: ocean@oceanchips.ru

Web: <http://oceanchips.ru/>

Адрес: 198099, г. Санкт-Петербург, ул. Калинина, д. 2, корп. 4, лит. А