



High Operating Temperature Radial Leaded Multilayer Ceramic Capacitors for Automotive Applications, 50 V_{DC}, 100 V_{DC}, 200 V_{DC}



DESIGN SUPPORT TOOLS

[click logo to get started](#)



FEATURES

- Registered trademark HOTcap®
- AEC-Q200 qualified with PPAP available
- High reliability MLCC insert with wet build process
- High operating temperature up to 200 °C ⁽¹⁾
- Available in class 1 and class 2
- High capacitance with small size
- Radial mounting style
- Crimp and straight leadstyles
- Material categorization: for definitions of compliance please see www.vishay.com/doc?99912



APPLICATIONS

- Automotive applications up to 200 °C ⁽¹⁾

Note

⁽¹⁾ 200 °C for max. 500 hours and 175 °C unlimited time

QUICK REFERENCE DATA						
DESCRIPTION	VALUE					
Ceramic Class	1			2		
Ceramic Dielectric	C0G			X0U		
Voltage (V _{DC})	50	100	200	50	100	200
Min. Capacitance (pF)	100	100	100	10 000	10 000	10 000
Max. Capacitance (pF)	12 000	12 000	8200	1 000 000	470 000	180 000
Mounting	Radial					

MARKING

Marking indicates capacitance value and tolerance in accordance with “EIA 198”.

OPERATING TEMPERATURE RANGE

-55 °C to +175 °C unlimited time
 -55 °C to +200 °C for max. 500 hours
 Voltage derating above 150 °C

TEMPERATURE CHARACTERISTICS

Class 1: C0G (± 30 ppm/K within -55 °C to +200 °C)
 Class 2: X0U also fulfilling X7R and X9V criteria
 X7R (+15 % / -15 % within -55 °C to +125 °C)
 X0U (+22 % / -56 % within -55 °C to +175 °C)
 X9V (+22 % / -82 % within -55 °C to +200 °C)
 See also chart “Capacitance Change vs. Temperature”

SECTIONAL SPECIFICATIONS

Climatic category (acc. to EN 60058-1)
55 / 125 / 21

APPROVALS

EIA 198
 IEC 60384-8
 IEC 60384-9
 AEC-Q200

DISSIPATION FACTOR

Class 1: 0.1 % max.
 (C ≤ 1000 pF, at 1 MHz, 1 V; C > 1000 pF, at 1 kHz, 1 V)
 Class 2: 2.5 % max. (at 1 kHz, 1 V)

DESIGN

- The capacitors consist of a high reliability MLCC
- Leads wires are 0.5 mm or 0.6 mm and are made of 100 % tinned copper clad steel wire
- The capacitors may be supplied with straight or kinked leads having a lead spacing of 2.5 mm and 5.0 mm
- Coating is made of flame retardant epoxy resin in accordance with UL 94 V-0

CAPACITANCE RANGE

100 pF to 1 μF

TOLERANCE ON CAPACITANCE

± 5 %, ± 10 %, ± 20 %

RATED VOLTAGE

50 V_{DC}, 100 V_{DC}, 200 V_{DC}

TEST VOLTAGE

- 50 V_{DC} and 100 V_{DC}: 250 % of rated voltage
- 200 V_{DC}: 200 % of rated voltage

INSULATION RESISTANCE

- 50 V_{DC}, 100 V_{DC}: 100 GΩ or 1000 ΩF whichever is less at rated voltage within 2 min of charging
- 200 V_{DC}: 10 GΩ or 100 ΩF whichever is less at rated voltage within 2 min of charging

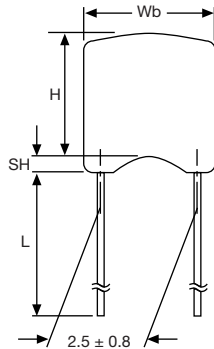
LEAD CONFIGURATION AND DIMENSIONS in millimeters

L2

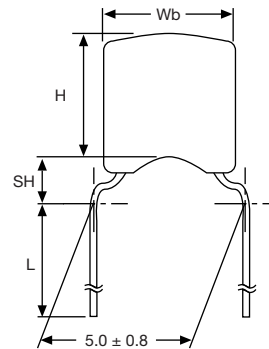
Component outline for lead spacing 2.5 mm ± 0.5 mm (straight leads)

H5

Component outline for lead spacing 5.0 mm ± 0.5 mm (flat bent leads)

SIZE CODE	Wb _{MAX.}	H _{MAX.}	T _{MAX.}	LEAD DIAMETER	MAXIMUM SEATING HEIGHT (SH)	
					L2	H5
15	3.0 - 3.8	2.0 - 3.8	1.6 - 2.6	0.50 ± 0.05	1.6	2.6
20	4.3 - 5.1	2.5 - 5.1	1.9 - 3.2	0.60 ± 0.05	1.6	2.6

Notes

- Bulk packed types have a standard lead length L = 30 mm ± 5 mm.
- L2 and H5 are preferred styles.

MARKING (two sides)

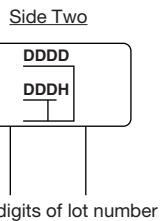
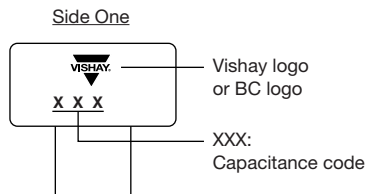
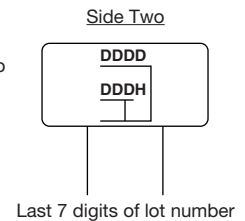
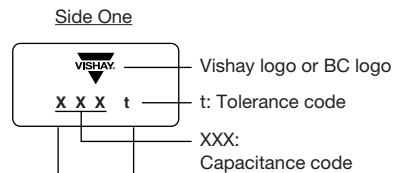
SIZE 15 CAPACITANCE VALUE ≥ 100 pF

SIZE 20

Notes

- Two significant digits followed by one digit for the multiplier: 1 = * 10, 2 = * 100, 3 = * 1000, 4 = * 10 000, 5 = * 100 000.
- The tolerance codes are J = ± 5 %, K = ± 10 %, M = ± 20 %

ORDERING CODE INFORMATION

K	104	K	15	X0U	F	5	3	H	5	H
1	2 3 4	5	6 7	8 9 10	11	12	13	14	15	16
Product Type	Capacitance (pF)	Capacitance Tolerance	Size Code	T.C. Code	Rated Voltage	Lead Diameter	Packaging / Lead Length	Lead Style	Lead Spacing	AEC-Q200 qualified



ORDERING CODE INFORMATION										
K = radial leaded MLCC	The first two digits are the significant figures of capacitance and the last digit is a multiplier as follows: 1 = * 10 2 = * 100 3 = * 1000 4 = * 10 000 5 = * 100 000	J = ± 5 % K = ± 10 % M = ± 20 %	Please refer to relevant ordering code tables in this datasheet	Please refer to relevant ordering code tables in this datasheet	F = 50 V _{DC} H = 100 V _{DC} K = 200 V _{DC}	5 = 0.50 mm ± 0.05 mm 6 = 0.60 mm ± 0.05 mm	3 = bulk T = tape and reel U = ammo	H = flat crimp L = straight K = outside crimp	2 = 2.5 mm 5 = 5.0 mm	H = high operating temperature



ORDERING CODES

DIELECTRIC COG			
CAP. (pF)	50 V _{DC}	100 V _{DC}	200 V _{DC}
100	K101#15C0GF5###H	K101#15C0GH5###H	K101#15C0GK5###H
120	K121#15C0GF5###H	K121#15C0GH5###H	K121#15C0GK5###H
150	K151#15C0GF5###H	K151#15C0GH5###H	K151#15C0GK5###H
180	K181#15C0GF5###H	K181#15C0GH5###H	K181#15C0GK5###H
220	K221#15C0GF5###H	K221#15C0GH5###H	K221#15C0GK5###H
270	K271#15C0GF5###H	K271#15C0GH5###H	K271#15C0GK5###H
330	K331#15C0GF5###H	K331#15C0GH5###H	K331#15C0GK5###H
390	K391#15C0GF5###H	K391#15C0GH5###H	K391#15C0GK5###H
470	K471#15C0GF5###H	K471#15C0GH5###H	K471#15C0GK5###H
560	K561#15C0GF5###H	K561#15C0GH5###H	K561#15C0GK5###H
680	K681#15C0GF5###H	K681#15C0GH5###H	K681#15C0GK5###H
820	K821#15C0GF5###H	K821#15C0GH5###H	K821#15C0GK5###H
1000	K102#15C0GF5###H	K102#15C0GH5###H	K102#15C0GK5###H
1200	K122#15C0GF5###H	K122#15C0GH5###H	K122#20C0GK6###H
1500	K152#15C0GF5###H	K152#15C0GH5###H	K152#20C0GK6###H
1800	K182#15C0GF5###H	K182#15C0GH5###H	K182#20C0GK6###H
2200	K222#15C0GF5###H	K222#20C0GH6###H	K222#20C0GK6###H
2700	K272#15C0GF5###H	K272#20C0GH6###H	K272#20C0GK6###H
3300	K332#15C0GF5###H	K332#20C0GH6###H	K332#20C0GK6###H
3900	K392#15C0GF5###H	K392#20C0GH6###H	K392#20C0GK6###H
4700	K472#20C0GF6###H	K472#20C0GH6###H	K472#20C0GK6###H
5600	K562#20C0GF6###H	K562#20C0GH6###H	K562#20C0GK6###H
6800	K682#20C0GF6###H	K682#20C0GH6###H	K682#20C0GK6###H
8200	K822#20C0GF6###H	K822#20C0GH6###H	K822#20C0GK6###H
10 000	K103#20C0GF6###H	K103#20C0GH6###H	/
12 000	K123#20C0GF6###H	K123#20C0GH6###H	/

DIELECTRIC XOJ			
CAP. (pF)	50 V _{DC}	100 V _{DC}	200 V _{DC}
10 000	K103#15X0UF5###H	K103#15X0UH5###H	K103#15X0UK5###H
15 000	K153#15X0UF5###H	K153#15X0UH5###H	K153#15X0UK5###H
22 000	K223#15X0UF5###H	K223#15X0UH5###H	K223#15X0UK5###H
27 000	K273#15X0UF5###H	K273#15X0UH5###H	K273#15X0UK5###H
33 000	K333#15X0UF5###H	K333#15X0UH5###H	K333#20X0UK6###H
39 000	K393#15X0UF5###H	K393#15X0UH5###H	K393#20X0UK6###H
47 000	K473#15X0UF5###H	K473#15X0UH5###H	K473#20X0UK6###H
56 000	K563#15X0UF5###H	K563#15X0UH5###H	K563#20X0UK6###H
68 000	K683#15X0UF5###H	K683#15X0UH5###H	K683#20X0UK6###H
82 000	K823#15X0UF5###H	K823#15X0UH5###H	K823#20X0UK6###H
100 000	K104#15X0UF5###H	K104#15X0UH5###H	K104#20X0UK6###H
120 000	K124#15X0UF5###H	K124#20X0UH6###H	K124#20X0UK6###H
150 000	K154#15X0UF5###H	K154#20X0UH6###H	K154#20X0UK6###H
180 000	K184#20X0UF6###H	K184#20X0UH6###H	K184#20X0UK6###H
220 000	K224#20X0UF6###H	K224#20X0UH6###H	/
270 000	K274#20X0UF6###H	K274#20X0UH6###H	/
330 000	K334#20X0UF6###H	K334#20X0UH6###H	/
390 000	K394#20X0UF6###H	K394#20X0UH6###H	/
470 000	K474#20X0UF6###H	K474#20X0UH6###H	/
560 000	K564#20X0UF6###H	/	/
680 000	K684#20X0UF6###H	/	/
820 000	K824#20X0UF6###H	/	/
1 000 000	K105#20X0UF6###H	/	/

Notes

- Lead diameter is 0.5 mm or 0.6 mm
- # 5th digit is capacitance tolerance code: ± 5 % = J; ± 10 % = K; ± 20 % = M
- # 13th digit is packaging code: Bulk = 3; Reel = T; Ammo = U
- # 14th digit is lead style code: L; H; K (L and H are preferred lead configuration)
- # 15th digit is lead spacing code: 2.5 mm = 2; 5.0 mm = 5



RATED VOLTAGE VS. TEMPERATURE (Typical)

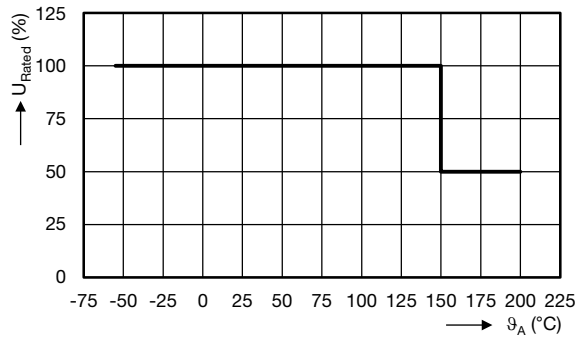

CAPACITANCE CHANGE VS. TEMPERATURE (Typical)

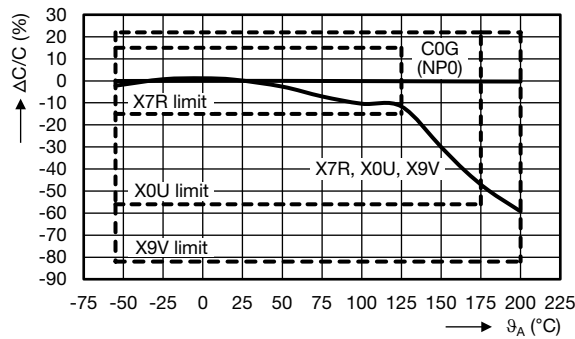

DISSIPATION FACTOR VS. TEMPERATURE (Typical)

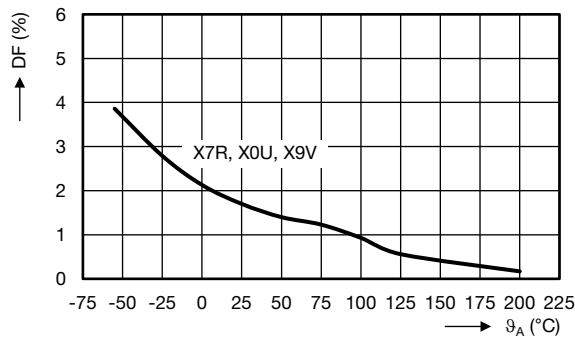

INSULATION RESISTANCE VS. TEMPERATURE (Typical)

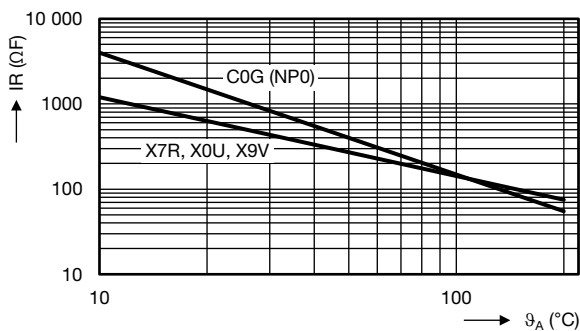

TAPING AND PACKAGING
LABELLING

Each reel is provided with a label showing the following details:

Manufacturer, K style, capacitance, tolerance, batch number, quantity of components, rated voltage, dielectric.

On special request other designations can be shown.

For example:

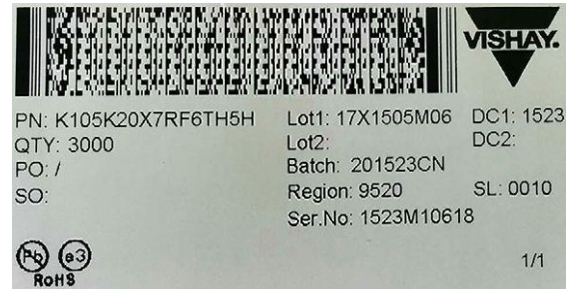

PACKAGING QUANTITIES AND BOX DIMENSIONS			
PACKAGING	SIZE CODE	SMALLEST PACKAGING QUANTITY (SPQ)	BOX DIMENSIONS L x W x H (mm)
Tape on reel	15	4000	370 x 370 x 60
	20	3000	
Ammopack	15, 20	2500	335 x 290 x 50
Bulk ⁽¹⁾	15, 20	5000	245 x 120 x 65

Note

⁽²⁾ SPQ contains one or a multiple of poly-bags, 1000 units per bag.

CAPACITORS ON TAPE			
PARAMETER	SYMBOL	DIMENSIONS	
		mm	INCH
Cut-off length	L	≤ 11	≤ 0.443
Lead end protrusion	L ₁	≤ 1	≤ 0.039
Height to seating plane (straight leads)	H	≥ 18	≥ 0.709
Height to seating plane (crimp leads)	H ₀	16.0 ± 0.5	0.630 ± 0.020
Top of component height	H ₁	≤ 32	≤ 1.26
Body inclination	Δh	0 ± 1.0	0 ± 0.039
Carrier tape width	W	18.0 +1.0/-0.5	0.709 +0.039/-0.020
Hold down tape width	W ₀	15.0 REF.	0.591 REF.
Sprocket hole position	W ₁	9.00 +0.075/-0.50	0.354 +0.030/-0.020
Lead space	F	2.50 +0.60/-0.40	0.100 +0.024/-0.016
		5.00 +0.60/-0.40	0.200 +0.024/-0.016
Sprocket hole pitch	P ₀	12.70 ± 0.30	0.500 ± 0.012
Sprocket hole center to lead center at F = 2.5 mm	P ₁	5.08 ± 0.70	0.200 ± 0.028
Sprocket hole center to lead center at F = 5 mm		3.85 ± 0.70	0.150 ± 0.028
Sprocket hole diameter	D ₀	4.0 ± 0.30	0.157 ± 0.012
Overall tape thickness	t	≤ 0.90	≤ 0.035
Wire lead diameter	d	0.50 ± 0.05	0.020 ± 0.002



CAPACITORS ON TAPE			
Taping pitch	P	12.7 REF.	0.50 REF.



REEL DATA

A maximum of 0.5 % of the total number of capacitors per reel may be missing.

A maximum of 1 consecutive vacant positions is followed by 6 consecutive components.

Tape begins and ends with a minimum of 4 empty positions (50 mm tape).

Maximum of 5 splicers per reel.

REEL

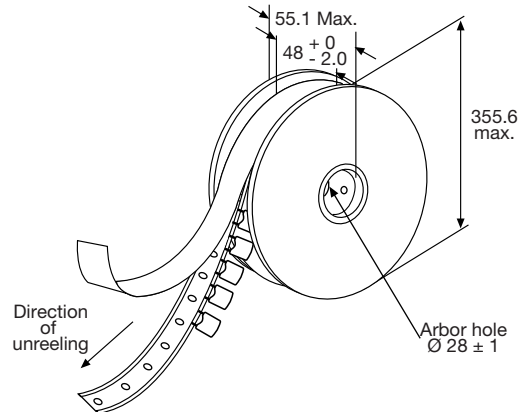

REEL DIMENSIONS

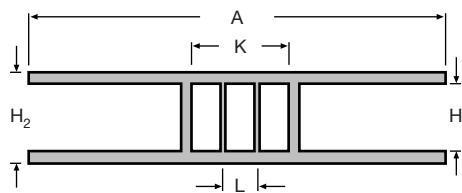

REEL SIZE		(mm)
A	Outer diameter	355.6 max.
L	Hole diameter	28 ± 1
K	Core diameter	90
H ₁	Internal width	48 +0/-2
H ₂	External width	55 max.

AMMOPACK DATA

A maximum of 0.5 % of the total number of capacitors per pack may be missing.

A maximum of 1 consecutive vacant positions is followed by 6 consecutive components.

Tape begins and ends with a minimum of 4 empty positions (50 mm tape).

Maximum of 5 splicers per pack.

The cumulative pitch tolerance over 20 consecutive units is not to exceed ± 1.0 mm.

Lead space (F) shall be measured at 3.6 mm ± 0.5 mm from the capacitor seating plane.

AMMOPACK

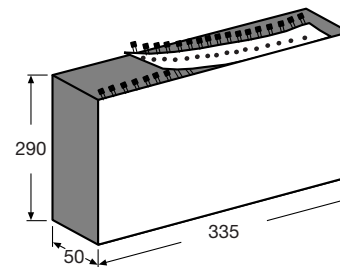

RELATED DOCUMENTS

General Information	www.vishay.com/doc?45214
---------------------	--

SAMPLE KIT

Part Number	HOTC-KIT-KH
Link	www.vishay.com/doc?45234



Disclaimer

ALL PRODUCT, PRODUCT SPECIFICATIONS AND DATA ARE SUBJECT TO CHANGE WITHOUT NOTICE TO IMPROVE RELIABILITY, FUNCTION OR DESIGN OR OTHERWISE.

Vishay Intertechnology, Inc., its affiliates, agents, and employees, and all persons acting on its or their behalf (collectively, "Vishay"), disclaim any and all liability for any errors, inaccuracies or incompleteness contained in any datasheet or in any other disclosure relating to any product.

Vishay makes no warranty, representation or guarantee regarding the suitability of the products for any particular purpose or the continuing production of any product. To the maximum extent permitted by applicable law, Vishay disclaims (i) any and all liability arising out of the application or use of any product, (ii) any and all liability, including without limitation special, consequential or incidental damages, and (iii) any and all implied warranties, including warranties of fitness for particular purpose, non-infringement and merchantability.

Statements regarding the suitability of products for certain types of applications are based on Vishay's knowledge of typical requirements that are often placed on Vishay products in generic applications. Such statements are not binding statements about the suitability of products for a particular application. It is the customer's responsibility to validate that a particular product with the properties described in the product specification is suitable for use in a particular application. Parameters provided in datasheets and / or specifications may vary in different applications and performance may vary over time. All operating parameters, including typical parameters, must be validated for each customer application by the customer's technical experts. Product specifications do not expand or otherwise modify Vishay's terms and conditions of purchase, including but not limited to the warranty expressed therein.

Except as expressly indicated in writing, Vishay products are not designed for use in medical, life-saving, or life-sustaining applications or for any other application in which the failure of the Vishay product could result in personal injury or death. Customers using or selling Vishay products not expressly indicated for use in such applications do so at their own risk. Please contact authorized Vishay personnel to obtain written terms and conditions regarding products designed for such applications.

No license, express or implied, by estoppel or otherwise, to any intellectual property rights is granted by this document or by any conduct of Vishay. Product names and markings noted herein may be trademarks of their respective owners.

Компания «Океан Электроники» предлагает заключение долгосрочных отношений при поставках импортных электронных компонентов на взаимовыгодных условиях!

Наши преимущества:

- Поставка оригинальных импортных электронных компонентов напрямую с производств Америки, Европы и Азии, а так же с крупнейших складов мира;
- Широкая линейка поставок активных и пассивных импортных электронных компонентов (более 30 млн. наименований);
- Поставка сложных, дефицитных, либо снятых с производства позиций;
- Оперативные сроки поставки под заказ (от 5 рабочих дней);
- Экспресс доставка в любую точку России;
- Помощь Конструкторского Отдела и консультации квалифицированных инженеров;
- Техническая поддержка проекта, помощь в подборе аналогов, поставка прототипов;
- Поставка электронных компонентов под контролем ВП;
- Система менеджмента качества сертифицирована по Международному стандарту ISO 9001;
- При необходимости вся продукция военного и аэрокосмического назначения проходит испытания и сертификацию в лаборатории (по согласованию с заказчиком);
- Поставка специализированных компонентов военного и аэрокосмического уровня качества (Xilinx, Altera, Analog Devices, Intersil, Interpoint, Microsemi, Actel, Aeroflex, Peregrine, VPT, Syfer, Eurofarad, Texas Instruments, MS Kennedy, Miteq, Cobham, E2V, MA-COM, Hittite, Mini-Circuits, General Dynamics и др.);

Компания «Океан Электроники» является официальным дистрибьютором и эксклюзивным представителем в России одного из крупнейших производителей разъемов военного и аэрокосмического назначения «JONHON», а так же официальным дистрибьютором и эксклюзивным представителем в России производителя высокотехнологичных и надежных решений для передачи СВЧ сигналов «FORSTAR».



JONHON

«JONHON» (основан в 1970 г.)

Разъемы специального, военного и аэрокосмического назначения:

(Применяются в военной, авиационной, аэрокосмической, морской, железнодорожной, горно- и нефтедобывающей отраслях промышленности)

«FORSTAR» (основан в 1998 г.)

ВЧ соединители, коаксиальные кабели, кабельные сборки и микроволновые компоненты:

(Применяются в телекоммуникациях гражданского и специального назначения, в средствах связи, РЛС, а так же военной, авиационной и аэрокосмической отраслях промышленности).



Телефон: 8 (812) 309-75-97 (многоканальный)

Факс: 8 (812) 320-03-32

Электронная почта: ocean@oceanchips.ru

Web: <http://oceanchips.ru/>

Адрес: 198099, г. Санкт-Петербург, ул. Калинина, д. 2, корп. 4, лит. А