

Safety Standard Recognized, 900 Series, Radial Disc, Encapsulated, AH Type, X1 400 VAC/Y1 250 VAC (Industrial Grade)

Overview

KEMET's 900 series encapsulated radial through-hole ceramic disc capacitors are specifically designed for interference-suppression AC line filtering applications. Having internationally recognized safety certifications, these capacitors are well-suited for applications that require keeping potentially disruptive or damaging line transients and EMI out of susceptible equipment. They are also an ideal solution when needing to suppress line disturbances at the source.

Safety Certified Capacitors are classified as either X and/or Y capacitors. Class X capacitors are primarily used in line-to-line (across-the-line) applications. In this application there is no danger of electric shock to humans should the capacitor fail, but could result in a risk of fire. The class Y capacitor is primarily used in line-to-ground (line by-pass) applications. In this application, failure of the capacitor could lead to danger of electric shock.

With a working voltage of 400 VAC in line-to-line (Class X) and 250 VAC in line-to-ground (Class Y) applications, these safety capacitors meet the impulse test criteria outlined in IEC Standard 60384. Meeting subclass X1 and Y1 requirements, these devices are certified to withstand impulses up to 4 KV (X1) and 8 KV (Y1) respectively. These encapsulated devices also meet the flame test requirements outlined in UL Standard 94V-0.



Ordering Information

C9	1	1	U	620	J	U	S	D	A	A	7317
Ceramic Series	Body Diameter	Lead Spacing ¹	Spec.	Capacitance Code (pF)	Capacitance Tolerance	Rated Voltage	Dielectric/Temp. Char.	Design	Lead Config. ²	Failure Rate	Packaging (C-Spec) ^{1,2}
C9 = Ceramic 900 Series	0 = 7.0 mm 1 = 8.0 mm 2 = 9.0 mm 3 = 10.0 mm 4 = 11.0 mm 5 = 12.0 mm 7 = 14.0 mm	1 = 10.0 mm	U = Safety	2 significant digits + Number of zeroes Use 9 for 1.0 - 9.9pF e.g., 2.2pF = 229	C = ±0.25pF D = ±0.5pF J = ±5% K = ±10% M = ±10%	U = X1 400 VAC / Y1 250 VAC	N = CH (NP0) S = SL Y = Y5P W = Y5U V = Y5V	D = Disc	A = Straight B = Vertical C = Outside Kink	A = N/A	7317 = Ammo Pack WL30 = Bulk/3.0 mm Lead length WL35 = Bulk/3.5 mm Lead length WL40 = Bulk/4.0 mm Lead length WL45 = Bulk/4.5 mm Lead length WL50 = Bulk/5.0 mm Lead length WL20 = Bulk/20 mm Lead length

¹ "Vertical Kink" and "Outside Kink" lead configurations cannot be combined with the bulk/20 mm lead length option (WL20). 20 mm lead length is only available on capacitors ordered with straight leads (lead configuration ordering code "A"). For nonstandard lead length inquiries, please contact KEMET.

² Bulk packaging lead length availability is dependent upon "Lead Configuration." See "Dimensions" section of this document to verify availability of a specific lead length option. For nonstandard lead length inquiries, please contact KEMET.

Lead Configurations

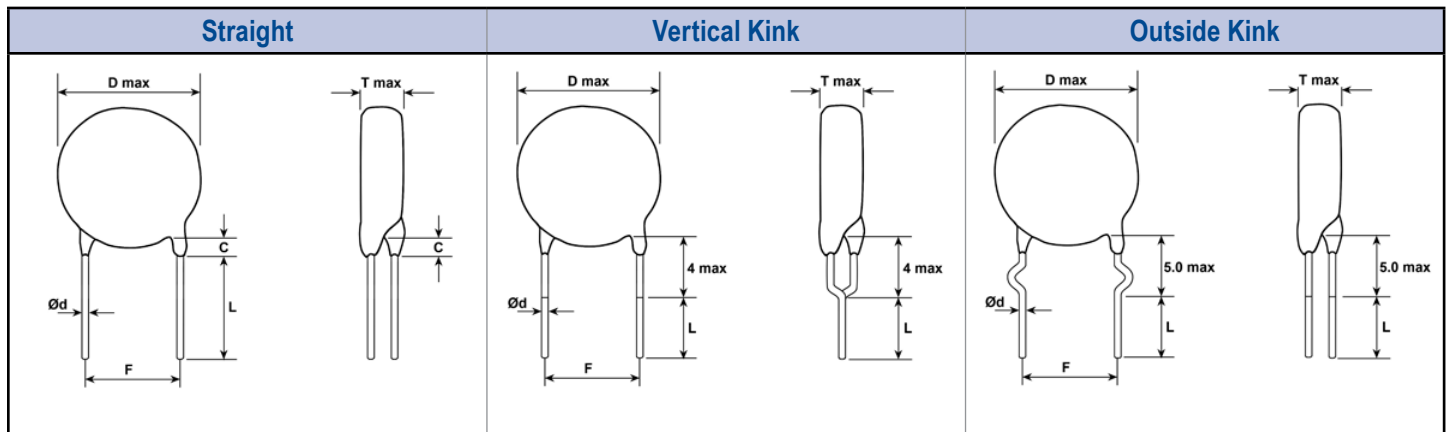

Dimensions – Millimeters

Lead Config.	Lead Config. Ordering Code ¹	F	Lead Spacing Tolerance	Packaging Type	L	Packaging C-Spec Ordering Code ²	D	T	e	Ød
		Lead Spacing			Lead Length		Body Diameter	Body Thickness	Lead Meniscus	Lead Dia.
Straight	A	10.0	±1.0	Ammo Pack	20.0 +1.5/-1.0	7317	See Table 1 - "Product Ordering Codes and Ratings"	3.0 maximum	0.5 ±0.1	
				Bulk	3.0 ±1.0	WL30				
					4.5 ±1.0	WL45				
					5.0 ±1.0	WL50				
Vertical Kink (Preformed)	B	10.0	±1.0	Ammo Pack	18.0 +2.0/-0	7317	See Table 1 - "Product Ordering Codes and Ratings"	3.0 maximum	0.5 ±0.1	
				Bulk	3.5 ±1.0	WL35				
					4.0 ±1.0	WL40				
Outside Kink (Preformed)	C	10.0	±1.0	Ammo Pack	18.0 +2.0/-0	7317	See Table 1 - "Product Ordering Codes and Ratings"	3.0 maximum	0.5 ±0.1	
				Bulk	3.5 ±1.0	WL35				
					4.0 ±1.0	WL40				
					5.0 ±1.0	WL50				

¹ Lead Configuration is identified in the 13th character of the ordering code. See "Lead Configuration" and "Ordering Information" sections of this document for further details.

² The "Packaging C-Spec" is a 4-digit numeric or alphanumeric code which identifies both the packaging type and lead length requirement. When ordering, this code must be included in the 15th through 18th character positions of the ordering code. See "Ordering Information" section of this document for further details.

Benefits

- Safety Standard Recognized (IEC 60384-14)
- Reliable operation up to 125°C
- Class X1/Y1
- 10 mm lead spacing
- Lead (Pb)-free and RoHS Compliant
- Halogen Free
- Capacitance offerings ranging from 2.0 pF up to 4,700 pF
- Available capacitance tolerances of ± 0.25 pF, ± 0.5 pF, $\pm 5\%$, $\pm 10\%$, and $\pm 20\%$
- High reliability
- Preformed (crimped) or straight lead configurations
- Non-polar device, minimizing installation concerns
- 100% pure matte tin-plated lead finish allowing for excellent solderability
- Encapsulation meets flammability standard UL 94V-0

Applications

Typical applications include:

- Line-to-line (Class X) filtering
- Line-to-ground (Class Y) filtering
- Antenna coupling
- Primary and secondary coupling (switching power supplies)
- Line disturbances suppression (motors and motor controls, relays, switching power supplies, and inverters)

Approval Standard and Certification No.

Safety Standard	Standard No.	Subclass	Working Voltage	Certificate No.
VDE (ENEC)	IEC 60384-14	X1	400 VAC	40036417
		Y1	250 VAC	

These devices are VDE/ENEC recognized for antenna coupling and AC line-to-line (Class X) and line-to-ground (Class Y) applications per IEC60384-14.

Environmental Compliance

These devices are Halogen Free and RoHS Compliant. They meet all requirements set forth by both EU and China RoHS directives.



RoHS Compliant



Halogen Free

General Specifications/Performance Characteristics

Dielectric/Temperature Characteristic:	CH(NP0)	SL	Y5P	Y5U	Y5V
Operating Temperature Range:	-25°C to +125°C				
Capacitance Change with Reference to +25°C and 0 VDC Applied (TCC):	±60 ppm/°C	-1,000 ~ +350 ppm/°C	±10%	+20%/-55%	~ +30%/-80%
Dielectric Withstanding Voltage	4,000 VAC (60 ±5 seconds at 25°C)				
Quality Factor (Q)	30 pF and above: ≥ 1,000 Below 30 pF: ≥ 400 +(20xC)*		See "Dissipation Factor"		
Dissipation Factor (tanδ) at +25°C ¹	See "Quality Factor"		2.50%	2.50%	5.0%
Insulation Resistance (IR) Limit at +25°C	10,000 MΩ Minimum (500 VDC applied for 60 ±5 seconds @ 25°C)				

* C = Nominal capacitance

¹ Capacitance and Dissipation Factor (DF) measured under the following conditions:

CH(NP0) and SL: 1 MHz ±100 kHz and 1.0 ±0.2 Vrms

X5P, Y5U and Y5V: 1 kHz ±50 Hz and 1.0 ±0.2 Vrms

Note: When measuring capacitance, it is important to ensure the set voltage level is held constant. The HP4284 & Agilent E4980 have a feature known as Automatic Level Control (ALC). The ALC feature should be switched to "ON."

Table 1 – Product Ordering Codes and Ratings

Dielectric/ Temp. Char.	KEMET Part Number	Capacitance	Capacitance Tolerance	Dimensions (mm)			Lead Spacing	
				Body Diameter (Maximum)	Body Thickness (Maximum)	Lead Diameter	Bulk Packaging	Ammo Packaging
CH (NP0)	C901U209CUND(1)A(2)	2.0 pF	±0.25 pF	7.0	5.0	0.5 ±0.1	10 mm	
	C901U309CUND(1)A(2)	3.0 pF						
	C901U409CUND(1)A(2)	4.0 pF						
	C901U509CUND(1)A(2)	5.0 pF						
	C901U609DUND(1)A(2)	6.0 pF						
	C901U709DUND(1)A(2)	7.0 pF	±0.5 pF	8.0	5.0	0.5 ±0.1	10 mm	
	C901U809DUND(1)A(2)	8.0 pF						
	C901U909DUND(1)A(2)	9.0 pF						
	C901U100DUND(1)A(2)	10 pF						
	C901U120JUND(1)A(2)	12 pF						
	C911U150JUND(1)A(2)	15 pF	±5%	8.0	5.0	0.5 ±0.1	10 mm	
	C911U180JUND(1)A(2)	18 pF						
	C911U200JUND(1)A(2)	20 pF						
	C911U220JUND(1)A(2)	22 pF						
	C911U240JUND(1)A(2)	24 pF						
C911U270JUND(1)A(2)	27 pF							
	KEMET Part Number	Capacitance	Capacitance Tolerance	Body Diameter (Maximum)	Body Thickness (Maximum)	Lead Diameter	Lead Spacing	

(1) To properly complete ordering code, insert the one-digit character code to reflect the required lead configuration: (See "Lead Configuration" section of this document, page 2, for further details.)

A = Straight

B = Vertical Kink

C = Outside Kink

(2) To properly complete ordering code, enter the four-digit numeric or alphanumeric "Packaging C-Spec Ordering Code." See "Dimensions" section of this document, page 2, for available options.

Table 1 – Product Ordering Codes and Ratings cont'd

Dielectric/ Temp. Char.	KEMET Part Number	Capacitance	Capacitance Tolerance	Dimensions (mm)			Lead Spacing	
				Body Diameter (Maximum)	Body Thickness (Maximum)	Lead Diameter	Bulk Packaging	Ammo Packaging
SL	C901U150JUSD(1)A(2)	15 pF	±5%	7.0	5.0	0.5 ±0.1	10 mm	
	C901U180JUSD(1)A(2)	18 pF						
	C901U200JUSD(1)A(2)	20 pF						
	C901U220JUSD(1)A(2)	22 pF						
	C901U240JUSD(1)A(2)	24 pF						
	C901U270JUSD(1)A(2)	27 pF						
	C901U300JUSD(1)A(2)	30 pF						
	C901U330JUSD(1)A(2)	33 pF						
	C901U360JUSD(1)A(2)	36 pF						
	C901U390JUSD(1)A(2)	39 pF						
	C911U470JUSD(1)A(2)	47 pF						
	C911U500JUSD(1)A(2)	50 pF						
	C911U510JUSD(1)A(2)	51 pF						
	C911U560JUSD(1)A(2)	56 pF						
	C911U620JUSD(1)A(2)	62 pF						
	C921U680JUSD(1)A(2)	68 pF						
C921U750JUSD(1)A(2)	75 pF							
C921U820JUSD(1)A(2)	82 pF							
C931U101JUSD(1)A(2)	100 pF							
Y5P	C901U101KUYD(1)A(2)	100 pF	±10%	7.0	5.0	0.5 ±0.1	10 mm	
	C901U151KUYD(1)A(2)	150 pF						
	C901U221KUYD(1)A(2)	220 pF						
	C901U331KUYD(1)A(2)	330 pF						
	C911U471KUYD(1)A(2)	470 pF						
	C921U561KUYD(1)A(2)	560 pF						
	C921U681KUYD(1)A(2)	680 pF						
C941U102KUYD(1)A(2)	1,000 pF							
Y5U	C911U102MUWD(1)A(2)	1,000 pF	±20%	8.0	5.0	0.5 ±0.1	10 mm	
	C921U152MUWD(1)A(2)	1,500 pF						
	C931U222MUWD(1)A(2)	2,200 pF						
	C951U332MUWD(1)A(2)	3,300 pF						
	C961U392MUWD(1)A(2)	3,900 pF						
	C971U472MUWD(1)A(2)	4,700 pF						
Y5V	C901U102MUVD(1)A(2)	1,000 pF	±20%	7.0	5.5	0.5 ±0.1	10 mm	
	C911U152MUVD(1)A(2)	1,500 pF						
	C921U222MUVD(1)A(2)	2,200 pF						
	C941U332MUVD(1)A(2)	3,300 pF						
	C951U472MUVD(1)A(2)	4,700 pF						
	KEMET Part Number	Capacitance	Capacitance Tolerance	Body Diameter (Maximum)	Body Thickness (Maximum)	Lead Diameter	Lead Spacing	

(1) To properly complete ordering code, insert the one-digit character code to reflect the required lead configuration: (See "Lead Configuration" section of this document, page 2, for further details.)

A = Straight

B = Vertical Kink

C = Outside Kink

(2) To properly complete ordering code, enter the four-digit numeric or alphanumeric "Packaging C-Spec Ordering Code." See "Dimensions" section of this document, page 2, for available options.

Table 2 – Performance & Reliability: Test Methods and Conditions

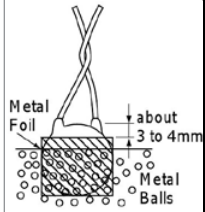
Item		Specification	Test Method																							
Operating Temperature Range		-25°C to +125°C																								
Dielectric Strength	Between lead wires	No failures	The capacitor shall not be damaged when 4,000 VAC(rms) is applied between the lead wires for 60 seconds.																							
	Body Insulation	No failures	The terminals (leads) of the capacitor shall be connected together. A metal foil is tightly wrapped around the body of the capacitor at a distance of about 3 to 4 mm from each terminal. The capacitor is then inserted into a container filled with metal balls approximately 1 mm in diameter. 4,000 VAC(rms) is applied for 60 seconds between the capacitor lead wires and metal balls. 																							
Insulation Resistance (IR)		10,000 MΩ minimum	The insulation resistance shall be measured with 500 ±50 VDC applied after 60 ±5 seconds of charging.																							
Capacitance		Within specified tolerance																								
Dissipation Factor (DF) or Q	<table border="1"> <thead> <tr> <th>Temperature Characteristics</th> <th>Specification</th> </tr> </thead> <tbody> <tr> <td>Y5P, Y5U</td> <td>DF ≤ 2.5%</td> </tr> <tr> <td>Y5V</td> <td>DF ≤ 5.0%</td> </tr> <tr> <td>NP0,SL</td> <td>≥ 30 pF: Q ≥ 1,000 < 30 pF: Q ≥ 400 + (20 x C) C = Nominal capacitance</td> </tr> </tbody> </table>		Temperature Characteristics	Specification	Y5P, Y5U	DF ≤ 2.5%	Y5V	DF ≤ 5.0%	NP0,SL	≥ 30 pF: Q ≥ 1,000 < 30 pF: Q ≥ 400 + (20 x C) C = Nominal capacitance	Y5P, Y5U and Y5V: Capacitance is measured at 1 kHz ±20% and 5 Vrms or less. (20 ±2°C) NP0 and SL: Capacitance is measured at 1 MHz ±20% and 1.0 ±0.2 Vrms (25°C)															
	Temperature Characteristics	Specification																								
	Y5P, Y5U	DF ≤ 2.5%																								
	Y5V	DF ≤ 5.0%																								
NP0,SL	≥ 30 pF: Q ≥ 1,000 < 30 pF: Q ≥ 400 + (20 x C) C = Nominal capacitance																									
<table border="1"> <thead> <tr> <th>Temperature Characteristics</th> <th>Capacitance Change</th> </tr> </thead> <tbody> <tr> <td>Y5P</td> <td>Within ±10%</td> </tr> <tr> <td>Y5U</td> <td>Within +22%/-56%</td> </tr> <tr> <td>Y5V</td> <td>Within ~+30%/-80%</td> </tr> <tr> <td>CH</td> <td>0 ±60 ppm/°C</td> </tr> <tr> <td>SL</td> <td>-1,000 ~+350 ppm°C (+20°C ~+85°C)</td> </tr> </tbody> </table>		Temperature Characteristics	Capacitance Change	Y5P	Within ±10%	Y5U	Within +22%/-56%	Y5V	Within ~+30%/-80%	CH	0 ±60 ppm/°C	SL	-1,000 ~+350 ppm°C (+20°C ~+85°C)	A capacitance measurement is made at each step specified: <table border="1"> <thead> <tr> <th>Step</th> <th>Temperature</th> </tr> </thead> <tbody> <tr> <td>1</td> <td>+20 ±2°C</td> </tr> <tr> <td>2</td> <td>-25 ±2°C</td> </tr> <tr> <td>3</td> <td>+20 ±2°C</td> </tr> <tr> <td>4</td> <td>+85 ±2°C</td> </tr> <tr> <td>5</td> <td>+20 ±2°C</td> </tr> </tbody> </table>	Step	Temperature	1	+20 ±2°C	2	-25 ±2°C	3	+20 ±2°C	4	+85 ±2°C	5	+20 ±2°C
Temperature Characteristics	Capacitance Change																									
Y5P	Within ±10%																									
Y5U	Within +22%/-56%																									
Y5V	Within ~+30%/-80%																									
CH	0 ±60 ppm/°C																									
SL	-1,000 ~+350 ppm°C (+20°C ~+85°C)																									
Step	Temperature																									
1	+20 ±2°C																									
2	-25 ±2°C																									
3	+20 ±2°C																									
4	+85 ±2°C																									
5	+20 ±2°C																									
Temperature Characteristics																										
Terminal Strength	Tensile	Lead wire or capacitor body shall not break.	With the termination in its normal position, the specimen is held by its body in such a manner that the axis of the termination is vertical; a tensile force of 10 N is applied to the termination in the direction of its axis and acting in a direction away from the body of the specimen.																							
	Bending	Lead wire or capacitor body shall not break.	With the termination in its normal position, the specimen is held by its body in such a manner that the axis of the termination is vertical; a mass force of 5 N is then suspended from the end of the termination. The body of the specimen is then inclined within a period of 2 to 3 seconds, through an angle of approximately 90° in the vertical plane and then resumed to its initial position over the same period of time; this operation constitutes one bend. One bend immediately followed by a second bend in the opposite direction.																							
Solderability		Lead wire should have a uniform coating of solder in the axial direction and over 3/4 of its circumference.	The lead wire of the capacitor is dipped into molten solder for 2 ±0.5 seconds. The depth of immersion is up to 1.5 mm (+5/-0 mm) from the root of lead wires. Solder Temperature: Lead free solder (Sn-3Ag - 0.5Cu) 245°C ±5°C.																							

¹ "Room Condition" is defined as follows: Temperature: 15 ~ 35°C/Humidity: 45 ~ 75%/Atmospheric Pressure: 86 ~ 106 kPa.

Table 2 – Performance & Reliability: Test Methods and Conditions cont'd

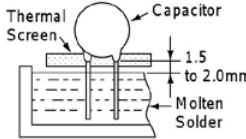
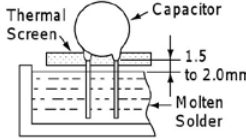
Item		Specification		Test Method											
Soldering Effect (Non-Preheat)	Appearance	No visual defect		<p>As shown in the figure below, the lead wires are immersed in molten solder up to 1.5 mm (+5/-0 mm) from the end of the epoxy meniscus (root of lead wire). Duration/Solder Temperature: 3.5 ±0.5 seconds/350°C ±10°C or 10 ±1 seconds/260°C ±5°C</p>  <p>Pre-treatment: Capacitor is stored at 85°C ±2°C for 1 hour and then placed at room condition¹ for 24 ±2 hours before initial measurements. Post-treatment: Capacitor is stored for 1 to 2 hours at room condition¹.</p>											
	IR	1,000 MΩ													
	Dielectric Strength	Per item 1													
	Capacitance	Y5P, Y5U and Y5V: Within ±10% SL, CH (NP0): Within ±2.5% or ±0.25 pF, whichever is larger.													
Soldering Effect (Preheat)	Appearance	No visual defect		<p>Capacitor is stored at 120°C +0/-5°C for 60 +0/-5 seconds. Then, as shown in the figure below, the lead wires are immersed in molten solder up to 1.5 mm (+5/-0mm) from the end of the epoxy meniscus (root of lead wire). Duration/Solder Temperature: 7.5 +0/-1 seconds/260°C ±5°C</p>  <p>Pre-treatment: Capacitor is stored at 85°C ±2°C for 1 hour and then placed at room condition¹ for 24 ±2 hours before initial measurements. Post-treatment: Capacitor is stored for 1 to 2 hours at room condition¹.</p>											
	IR	1,000 MΩ													
	Dielectric Strength	Per item 1													
	Capacitance	Y5P, Y5U and Y5V: Within ±10% SL, CH (NP0): Within ±2.5% or ±0.25 pF, whichever is larger.													
Biased Humidity	Appearance	No visual defect		Steady State Humidity:	Load Humidity:										
	Capacitance	<table border="1"> <thead> <tr> <th>Temperature Characteristics</th> <th>Capacitance Change</th> </tr> </thead> <tbody> <tr> <td>Y5P</td> <td>Within ±10%</td> </tr> <tr> <td>Y5U</td> <td>Within ±20%</td> </tr> <tr> <td>Y5V</td> <td>Within ±30%</td> </tr> <tr> <td>SL CH (NP0)</td> <td>Within ±2.5% or ±0.25 pF, whichever is larger.</td> </tr> </tbody> </table>		Temperature Characteristics	Capacitance Change	Y5P	Within ±10%	Y5U	Within ±20%	Y5V	Within ±30%	SL CH (NP0)	Within ±2.5% or ±0.25 pF, whichever is larger.	90 to 95% humidity at 40°C ±2°C for 500 ±12 hours.	90 to 95% humidity at 40°C ±2°C for 500 ±12 hours with full rated voltage applied.
		Temperature Characteristics	Capacitance Change												
		Y5P	Within ±10%												
		Y5U	Within ±20%												
	Y5V	Within ±30%													
	SL CH (NP0)	Within ±2.5% or ±0.25 pF, whichever is larger.													
	DF	Y5P and Y5U: 5.0% maximum Y5V: 7.5% maximum													
Q	SL&CH(NP0): Less than 30 pF: Q ≥ 100+10×C/3 More than 30 pF: Q ≥ 200 C = Nominal capacitance														
IR	Y5P, Y5V and Y5U: 3,000 MΩ minimum SL and CH (NP0): 1,000 MΩ minimum														
Dielectric Strength	No failures		<p>Post Treatment: Capacitor is stored for 1 to 2 hours at room condition¹.</p>	<p>Post Treatment: Capacitor is stored for 1 to 2 hours at room condition¹.</p>											

¹ "Room Condition" is defined as follows: Temperature: 15 ~ 35°C/Humidity: 45 ~ 75%/Atmospheric Pressure: 86 ~ 106 kPa.

Table 2 – Performance & Reliability: Test Methods and Conditions cont'd

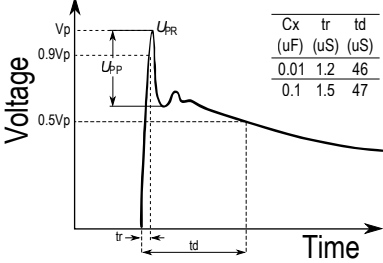
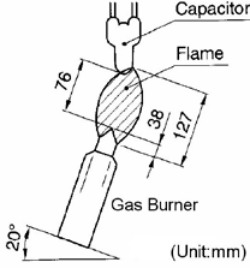
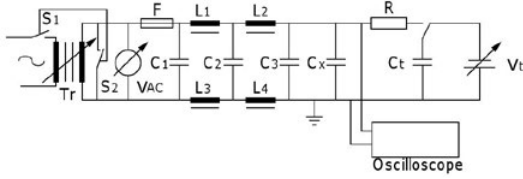
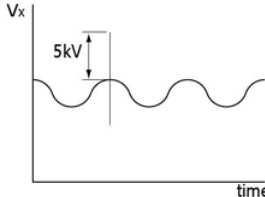
Item		Specification	Test Method																			
High Temperature Life	Appearance	No visual defect	<p>Impulse Voltage: Each individual capacitor is subjected to three 8 kv impulses prior to life testing.</p>  <table border="1" data-bbox="1136 409 1247 499"> <tr> <td>Cx</td> <td>tr</td> <td>td</td> </tr> <tr> <td>(uF)</td> <td>(uS)</td> <td>(uS)</td> </tr> <tr> <td>0.01</td> <td>1.2</td> <td>46</td> </tr> <tr> <td>0.1</td> <td>1.5</td> <td>47</td> </tr> </table>	Cx	tr	td	(uF)	(uS)	(uS)	0.01	1.2	46	0.1	1.5	47							
	Cx	tr		td																		
	(uF)	(uS)		(uS)																		
	0.01	1.2		46																		
0.1	1.5	47																				
Capacitance Change	Y5P, Y5V and Y5U: Within $\pm 20\%$ SL and CH (NPO): Within ± 3 or ± 0.3 pF, whichever is larger.																					
IR	3,000 M Ω minimum SL and CH (NPO): 1,000 M Ω minimum																					
Dielectric Strength	No failures																					
Flame Test	<p>The capacitor flame extinguishes as follows:</p> <table border="1" data-bbox="457 934 805 1062"> <thead> <tr> <th>Cycle</th> <th>Time</th> </tr> </thead> <tbody> <tr> <td>1 ~ 4</td> <td>30 seconds maximum</td> </tr> <tr> <td>5</td> <td>60 seconds maximum</td> </tr> </tbody> </table>	Cycle	Time	1 ~ 4	30 seconds maximum	5	60 seconds maximum	<p>The capacitor is exposed to a flame for 15 seconds and then removed for 15 seconds. This test is repeated for 5 cycles.</p> 														
Cycle	Time																					
1 ~ 4	30 seconds maximum																					
5	60 seconds maximum																					
Active Flammability	The cheesecloth should not ignite.	<p>The capacitors are individually wrapped in at least one, but not more than two, complete layers of cheesecloth. They are then subjected to 20 discharges. The interval between successive discharges is 5 seconds. The VAC is maintained for 2 minutes after the last discharge.</p>  <table border="1" data-bbox="850 1459 1523 1663"> <tbody> <tr> <td>C_{1,2}</td> <td>1 μF $\pm 10\%$</td> <td>C₃</td> <td>0.033 μF $\pm 5\%$ 10 kV</td> </tr> <tr> <td>L₁₋₄</td> <td>1.5 Mh $\pm 20\%$ 16A Rod core choke</td> <td>Cx</td> <td>Test capacitor</td> </tr> <tr> <td>R</td> <td>100 $\pm 2\%$</td> <td>V_{AC}</td> <td>VR $\pm 5\%$</td> </tr> <tr> <td>Ct</td> <td>3 μF $\pm 5\%$ 10 kV</td> <td>V_R</td> <td>Rated Voltage</td> </tr> <tr> <td>F</td> <td>Fuse, Rated 10A</td> <td>Vt</td> <td>Voltage applied to Ct</td> </tr> </tbody> </table> 	C _{1,2}	1 μ F $\pm 10\%$	C ₃	0.033 μ F $\pm 5\%$ 10 kV	L ₁₋₄	1.5 Mh $\pm 20\%$ 16A Rod core choke	Cx	Test capacitor	R	100 $\pm 2\%$	V _{AC}	VR $\pm 5\%$	Ct	3 μ F $\pm 5\%$ 10 kV	V _R	Rated Voltage	F	Fuse, Rated 10A	Vt	Voltage applied to Ct
C _{1,2}	1 μ F $\pm 10\%$	C ₃	0.033 μ F $\pm 5\%$ 10 kV																			
L ₁₋₄	1.5 Mh $\pm 20\%$ 16A Rod core choke	Cx	Test capacitor																			
R	100 $\pm 2\%$	V _{AC}	VR $\pm 5\%$																			
Ct	3 μ F $\pm 5\%$ 10 kV	V _R	Rated Voltage																			
F	Fuse, Rated 10A	Vt	Voltage applied to Ct																			

¹ "Room Condition" is defined as follows: Temperature: 15 ~ 35°C/Humidity: 45 ~ 75%/Atmospheric Pressure: 86 ~ 106 kPa.

Table 2 – Performance & Reliability: Test Methods and Conditions cont'd

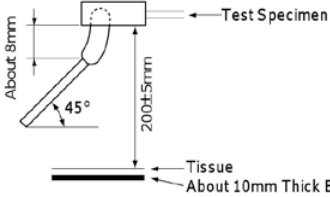
Item		Specification		Test Method															
Passive Flammability		The burning time should not exceed 30 seconds. The tissue paper should not ignite.		The capacitor under test is held into a flame and in a position which best promotes burning. Each specimen is exposed to the flame one time. 															
				Time of exposure to flame: 30 seconds Length of flame: 12 ±1 mm Gas burner length: 35 mm minimum Inside diameter: 0.5 ±0.1 mm Outside diameter: 0.9 mm maximum Gas butane gas purity: 95% minimum															
Temperature Cycle	Appearance	No visual defect		The capacitor is subjected to 5 temperature cycles. (Temperature Cycle) <table border="1" data-bbox="945 961 1425 1209"> <thead> <tr> <th>Step</th> <th>Temperature (°C)</th> <th>Time (minutes)</th> </tr> </thead> <tbody> <tr> <td>1</td> <td>-25 +0/-3</td> <td>30</td> </tr> <tr> <td>2</td> <td>Room temperature</td> <td>3</td> </tr> <tr> <td>3</td> <td>125 +3/-0</td> <td>30</td> </tr> <tr> <td>4</td> <td>Room temperature</td> <td>3</td> </tr> </tbody> </table> Pre-treatment: Capacitor shall be stored at 85 ±2 for 1 hour then placed at room condition ¹ for 24 ±2 hours. Post-treatment: Capacitor is stored for 1 to 2 hours at room condition ¹ .	Step	Temperature (°C)	Time (minutes)	1	-25 +0/-3	30	2	Room temperature	3	3	125 +3/-0	30	4	Room temperature	3
	Step	Temperature (°C)	Time (minutes)																
	1	-25 +0/-3	30																
	2	Room temperature	3																
	3	125 +3/-0	30																
	4	Room temperature	3																
Capacitance	<table border="1" data-bbox="435 831 841 1041"> <thead> <tr> <th>Temperature Characteristics</th> <th>Capacitance Change</th> </tr> </thead> <tbody> <tr> <td>SL, CH (NP0)</td> <td>Within ±5%</td> </tr> <tr> <td>Y5P</td> <td>Within ±10%</td> </tr> <tr> <td>Y5U, Y5V</td> <td>Within ±20%</td> </tr> </tbody> </table>		Temperature Characteristics	Capacitance Change	SL, CH (NP0)	Within ±5%	Y5P	Within ±10%	Y5U, Y5V	Within ±20%									
	Temperature Characteristics	Capacitance Change																	
	SL, CH (NP0)	Within ±5%																	
Y5P	Within ±10%																		
Y5U, Y5V	Within ±20%																		
DF/Q	SL, CH (NP0)	≥30 pF: Q ≥ 350 <30 pF: Q ≥ 275 +5/2C C = Nominal capacitance																	
	Y5P	DF ≤ 5%																	
Y5U, Y5V	DF ≤ 7.5%																		
IR	3,000 MΩ minimum SL and CH (NPO): 1,000 MΩ minimum																		
Dielectric Strength	No failures																		

¹ "Room Condition" is defined as follows: Temperature: 15 ~ 35°C/Humidity: 45 ~ 75%/Atmospheric Pressure: 86 ~ 106 kPa.

Soldering and Mounting Information

Soldering:

When soldering this product to a PCB/PWB, do not exceed the solder heat resistance specification of the capacitor. Subjecting this product to excessive heating could reflow the solder joint between the lead and ceramic element and/or may result in thermal shocks that can crack the ceramic element.

When soldering these capacitors with a soldering iron, it should be performed under the following conditions:

- Temperature of iron-tip: 400°C maximum
- Soldering iron wattage: 50 W maximum
- Soldering time: 3.5 seconds maximum

Cleaning (ultrasonic cleaning):

To perform ultrasonic cleaning, observe the following conditions:

- Rinse bath capacity: Output of 20 watts per liter or less
- Rinsing time: 5 minute maximum
- Do not vibrate the PCB/PWB directly
- Excessive ultrasonic cleaning may lead to fatigue destruction of the lead wires

Construction

Reference	Item	Material
1	Encapsulation ¹	Epoxy resin, Pigment (Blue/UL 94 V-0)
2	Dielectric Material	BaTiO ₃
3	Solder	Sn 96.5, Ag 3, Cu 0.5
4	Electrodes	Ag (Glass frit)
5	Lead Wires	Tinned copper clad steel wire (Sn Plating 100% 3-7 μm)

¹ The minimum thickness of the insulation coating (encapsulation) is 0.4 mm

Note: Image is exaggerated in order to clearly identify all components of construction.

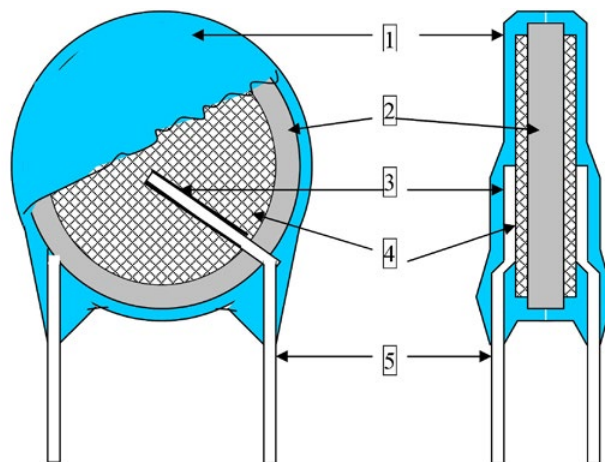

Capacitor Marking

These capacitors shall be stamped or laser marked with KEMET's trademark, type designation, capacitor class, rated voltage, rated capacitance, and capacitance tolerance codes. In addition, all devices are marked with the recognized approval mark and a date/lot code for traceability. Marking will be supplied either on one side or both sides of the encapsulated capacitor body. All marking shall be legible to allow for clear identification of the component. Marking appears in legible contrast. Illustrated below is an example of the marking format and content. (Two sided marking is limited to capacitors with body diameters ≤ 8.0 mm.)

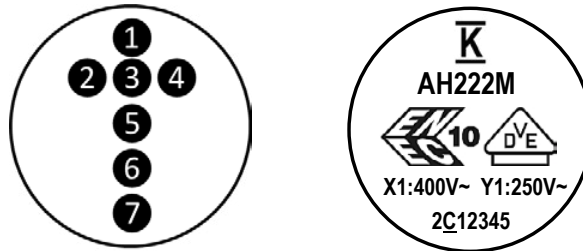

Location #	Description	Detail								
1	KEMET Trademark									
2 ¹	Type Designation (2 characters)	AH								
3 ¹	Rated Capacitance (3 numeric characters)	First two digits are the significant figures of capacitance. Third digit indicates the additional number of zeros. For example, 2,200 pF is identified as 222. (For values below 10 pF an "R" is used in place of the decimal point, e.g., 2R0 = 2.0 pF.)								
4	Capacitance Tolerance Code (1 character)	C = 0.25 pF, D = 0.5 pF, J = $\pm 5\%$, K = $\pm 10\%$, M = $\pm 20\%$								
5	VDE & ENEC approval mark IEC 60384-14 3rd (2005)									
6	Capacitor Class and Rated Voltage	X1: 400 V~ Y1: 250 V~								
7	Date/Lot Code	Date/Lot Code, e.g., 3C12345 <table border="1"> <thead> <tr> <th>3</th> <th>C</th> <th>1</th> <th>2345</th> </tr> </thead> <tbody> <tr> <td>Last digit of year, e.g., 3 = 2013</td> <td>Manufacturing Location Code</td> <td>Manufacturing Month: 1-9 = Jan - Sept A = October N = November D = December</td> <td>Last 4 digits of lot no.</td> </tr> </tbody> </table>	3	C	1	2345	Last digit of year, e.g., 3 = 2013	Manufacturing Location Code	Manufacturing Month: 1-9 = Jan - Sept A = October N = November D = December	Last 4 digits of lot no.
3	C	1	2345							
Last digit of year, e.g., 3 = 2013	Manufacturing Location Code	Manufacturing Month: 1-9 = Jan - Sept A = October N = November D = December	Last 4 digits of lot no.							

Packaging Quantities

Packaging Type	Loose (Bulk Bag)	Carrier Tape Quantity
		(25.4 mm Pitch ¹)
Ammo Pack	N/A	500 pieces/box
Bulk	500 pieces/bag	N/A

¹ For details regarding component pitch on carrier tape, see "Ammo Pack Taping Format" and "Ammo Pack Taping Specifications" sections of this document.

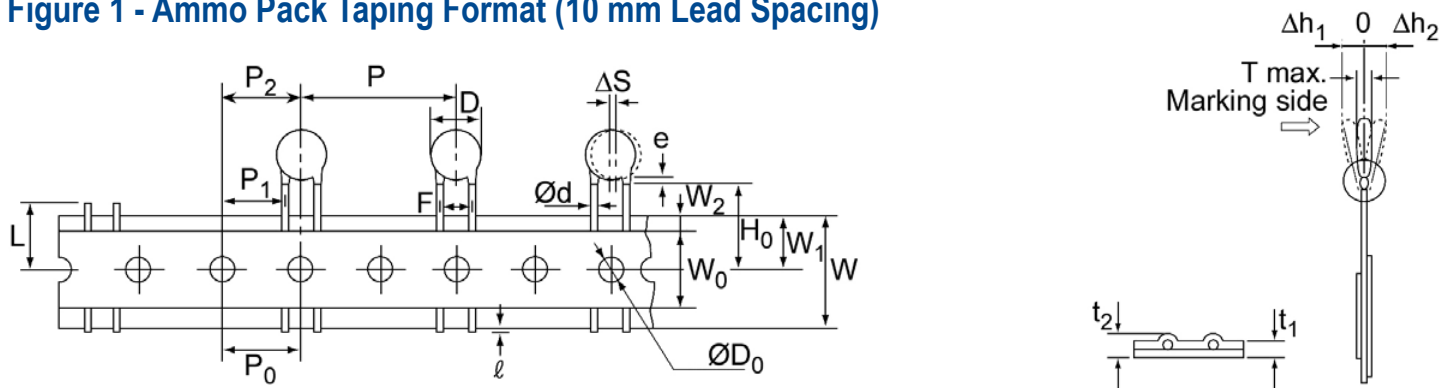
Figure 1 - Ammo Pack Taping Format (10 mm Lead Spacing)**Table 3 – Ammo Pack Taping Specifications**

Lead Spacing		10 mm	
Lead Style		Straight	Preformed ¹
Item	Symbol	Dimensions (mm)	
Lead Spacing	F	10.0 ±1.0	
Component Pitch	P	25.4 ±2	
Sprocket Hole Pitch	P ₀	12.7 ±0.3	
Sprocket Hole Center to Component Center	P ₂	12.7 ±1.5	
Sprocket Hole Center to Lead Center	P ₁	7.7 ±1.5	
Body Diameter	D	See "Product Ordering Codes and Ratings" section of this document.	
Component Alignment (side/side)	ΔS	0 ±2.0	
Carrier Tape Width	W	18.0 +1.0/-0.5	
Sprocket Hole Position	W ₁	9.0 ±0.5	
Height to Seating Plane ² (preformed leads ¹)	H ₀	N/A	18.0 +2.0/-0
Height to Seating Plane ² (straight leads)	H	20.0 +1.5/-1.0	N/A
Lead Protrusion	ℓ	2.0 maximum	
Diameter of Sprocket Hole	D ₀	4.0 ±0.2	
Lead Diameter	φd	0.5 ±0.1	
Carrier Tape Thickness	t ₁	0.6 ±0.3	
Total Thickness (Carrier Tape, Hold-Down Tape and Lead)	t ₂	1.5 maximum	
Component Alignment (front/back)	Δh ₁	2.0 maximum	
	Δh ₂	2.0 maximum	
Cut Out Length	L	11.0 maximum	
Hold-Down Tape Width	W ₀	11.0 minimum	
Hold-Down Tape Position	W ₂	1.5 ±1.5	
Coating Extension on Leads (meniscus)	e	3.0 maximum for straight lead; not to exceed the bend for preformed ¹ lead configurations.	
Body Thickness	T	See "Product Ordering Codes and Ratings" section of this document.	

¹Preformed (crimped) lead configurations include vertical kink and outside kink. See "Lead Configurations" and "Ordering Information" sections of this document for further details.

²Also referred to as "lead length" in this document.

Application Notes:

Storage and Operating Conditions:

The insulating coating of these devices does not form an air and moisture-tight seal. Avoid exposure to moisture and do not use or store these devices in a corrosive atmosphere, especially where chloride gas, sulfide gas, acid, alkali, salt, or the like are present. Before cleaning, bonding or molding these devices, it is important to verify that your process does not affect product quality and performance. KEMET recommends testing and evaluating the performance of a cleaned, bonded or molded product prior to implementing and/or qualifying any of these processes. Store the capacitors where the temperature and relative humidity do not exceed 40 degrees Centigrade and 70% respectively. For optimum solderability, capacitor stock should be used promptly, preferably within 6 months of receipt.

Working Voltage:

Application voltage (V_{p-p} or V_{o-p}) must not exceed the voltage rating of the capacitor. Irregular voltages can be generated for a transient period of time when voltage is initially applied and/or removed from a circuit. It is important to choose a capacitor with a voltage rating greater than or equal to these irregular voltages.

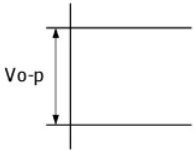
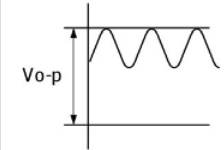
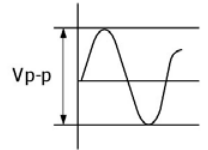
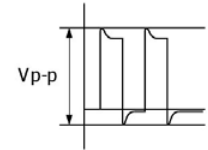
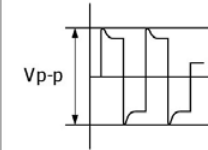
Voltage	DC Voltage	DC +AC Voltage	AC Voltage	Pulse Voltage (1)	Pulse Voltage (2)
Positional Measurement					

Operating Temperature and Self-Generating Heat:

The surface temperature of a capacitor should be kept below the upper limit of its rated operating temperature range. Be sure to take into account the heat generated by the capacitor itself. When the capacitor is used in a high-frequency current, pulse current or similar current, it may self-generate heat due to dielectric loss. Temperature rise due to self-generated heating should not exceed 20°C (while operated at an atmosphere temperature of 25°C).

Handling - Vibration and Impact:

Do not expose these devices or their leads to excessive shock or vibration during use.

FAILURE TO FOLLOW THE ABOVE CAUTIONS MAY RESULT, WORST CASE, IN A SHORT CIRCUIT AND CAUSE FUMING OR PARTIAL DISPERSION WHEN THE PRODUCT IS USED.

KEMET Corporation World Headquarters

2835 KEMET Way
Simpsonville, SC 29681

Mailing Address:
P.O. Box 5928
Greenville, SC 29606

www.kemet.com
Tel: 864-963-6300
Fax: 864-963-6521

Corporate Offices
Fort Lauderdale, FL
Tel: 954-766-2800

North America

Southeast
Lake Mary, FL
Tel: 407-855-8886

Northeast
Wilmington, MA
Tel: 978-658-1663

Central
Novi, MI
Tel: 248-994-1030

West
Milpitas, CA
Tel: 408-433-9950

Mexico
Guadalajara, Jalisco
Tel: 52-33-3123-2141

Europe

Southern Europe
Paris, France
Tel: 33-1-4646-1006

Sasso Marconi, Italy
Tel: 39-051-939111

Central Europe
Landsberg, Germany
Tel: 49-8191-3350800

Kamen, Germany
Tel: 49-2307-438110

Northern Europe
Bishop's Stortford, United Kingdom
Tel: 44-1279-460122

Espoo, Finland
Tel: 358-9-5406-5000

Asia

Northeast Asia
Hong Kong
Tel: 852-2305-1168

Shenzhen, China
Tel: 86-755-2518-1306

Beijing, China
Tel: 86-10-5829-1711

Shanghai, China
Tel: 86-21-6447-0707

Taipei, Taiwan
Tel: 886-2-27528585

Southeast Asia
Singapore
Tel: 65-6586-1900

Penang, Malaysia
Tel: 60-4-6430200

Bangalore, India
Tel: 91-806-53-76817

Note: KEMET reserves the right to modify minor details of internal and external construction at any time in the interest of product improvement. KEMET does not assume any responsibility for infringement that might result from the use of KEMET Capacitors in potential circuit designs. KEMET is a registered trademark of KEMET Electronics Corporation.

Other KEMET Resources

Tools	
Resource	Location
Configure A Part: CapEdge	http://capacitoredge.kemet.com
SPICE & FIT Software	http://www.kemet.com/spice
Search Our FAQs: KnowledgeEdge	http://www.kemet.com/keask
Electrolytic LifeCalculator	http://www.kemet.com:8080/elc

Product Information	
Resource	Location
Products	http://www.kemet.com/products
Technical Resources (Including Soldering Techniques)	http://www.kemet.com/technicalpapers
RoHS Statement	http://www.kemet.com/rohs
Quality Documents	http://www.kemet.com/qualitydocuments

Product Request	
Resource	Location
Sample Request	http://www.kemet.com/sample
Engineering Kit Request	http://www.kemet.com/kits

Contact	
Resource	Location
Website	www.kemet.com
Contact Us	http://www.kemet.com/contact
Investor Relations	http://www.kemet.com/ir
Call Us	1-877-MyKEMET
Twitter	http://twitter.com/kemetcapacitors

Disclaimer

All product specifications, statements, information and data (collectively, the "Information") in this datasheet are subject to change. The customer is responsible for checking and verifying the extent to which the Information contained in this publication is applicable to an order at the time the order is placed.

All Information given herein is believed to be accurate and reliable, but it is presented without guarantee, warranty, or responsibility of any kind, expressed or implied.

Statements of suitability for certain applications are based on KEMET Electronics Corporation's ("KEMET") knowledge of typical operating conditions for such applications, but are not intended to constitute – and KEMET specifically disclaims – any warranty concerning suitability for a specific customer application or use. The Information is intended for use only by customers who have the requisite experience and capability to determine the correct products for their application. Any technical advice inferred from this Information or otherwise provided by KEMET with reference to the use of KEMET's products is given gratis, and KEMET assumes no obligation or liability for the advice given or results obtained.

Although KEMET designs and manufactures its products to the most stringent quality and safety standards, given the current state of the art, isolated component failures may still occur. Accordingly, customer applications which require a high degree of reliability or safety should employ suitable designs or other safeguards (such as installation of protective circuitry or redundancies) in order to ensure that the failure of an electrical component does not result in a risk of personal injury or property damage.

Although all product-related warnings, cautions and notes must be observed, the customer should not assume that all safety measures are indicated or that other measures may not be required.

Компания «Океан Электроники» предлагает заключение долгосрочных отношений при поставках импортных электронных компонентов на взаимовыгодных условиях!

Наши преимущества:

- Поставка оригинальных импортных электронных компонентов напрямую с производств Америки, Европы и Азии, а так же с крупнейших складов мира;
- Широкая линейка поставок активных и пассивных импортных электронных компонентов (более 30 млн. наименований);
- Поставка сложных, дефицитных, либо снятых с производства позиций;
- Оперативные сроки поставки под заказ (от 5 рабочих дней);
- Экспресс доставка в любую точку России;
- Помощь Конструкторского Отдела и консультации квалифицированных инженеров;
- Техническая поддержка проекта, помощь в подборе аналогов, поставка прототипов;
- Поставка электронных компонентов под контролем ВП;
- Система менеджмента качества сертифицирована по Международному стандарту ISO 9001;
- При необходимости вся продукция военного и аэрокосмического назначения проходит испытания и сертификацию в лаборатории (по согласованию с заказчиком);
- Поставка специализированных компонентов военного и аэрокосмического уровня качества (Xilinx, Altera, Analog Devices, Intersil, Interpoint, Microsemi, Actel, Aeroflex, Peregrine, VPT, Syfer, Eurofarad, Texas Instruments, MS Kennedy, Miteq, Cobham, E2V, MA-COM, Hittite, Mini-Circuits, General Dynamics и др.);

Компания «Океан Электроники» является официальным дистрибьютором и эксклюзивным представителем в России одного из крупнейших производителей разъемов военного и аэрокосмического назначения «**JONHON**», а так же официальным дистрибьютором и эксклюзивным представителем в России производителя высокотехнологичных и надежных решений для передачи СВЧ сигналов «**FORSTAR**».



JONHON

«**JONHON**» (основан в 1970 г.)

Разъемы специального, военного и аэрокосмического назначения:

(Применяются в военной, авиационной, аэрокосмической, морской, железнодорожной, горно- и нефтедобывающей отраслях промышленности)

«**FORSTAR**» (основан в 1998 г.)

ВЧ соединители, коаксиальные кабели,
кабельные сборки и микроволновые компоненты:

(Применяются в телекоммуникациях гражданского и специального назначения, в средствах связи, РЛС, а так же военной, авиационной и аэрокосмической отраслях промышленности).



Телефон: 8 (812) 309-75-97 (многоканальный)

Факс: 8 (812) 320-03-32

Электронная почта: ocean@oceanchips.ru

Web: <http://oceanchips.ru/>

Адрес: 198099, г. Санкт-Петербург, ул. Калинина, д. 2, корп. 4, лит. А